

CD4042A Types

CMOS Quad Clocked "D" Latch

The RCA-CD4042A types contain four latch circuits, each strobed by a common clock. Complementary buffered outputs are available from each circuit. The impedance of the n- and p-channel output devices is balanced and all outputs are electrically identical. Information present at the data input is transferred to outputs Q and Q̄ during the CLOCK level which is programmed by the POLARITY input. For POLARITY = 0 the transfer occurs during the 0 CLOCK level and for POLARITY = 1 the transfer occurs during the 1 CLOCK level. The outputs follow the data input providing the CLOCK

and POLARITY levels defined above are present. When a CLOCK transition occurs (positive for POLARITY = 0 and negative for POLARITY = 1) the information present at the input during the CLOCK transition is retained at the outputs until an opposite CLOCK transition occurs.

These types are supplied in 16-lead hermetic dual-in-line ceramic packages (D and F suffixes), 16-lead dual-in-line plastic package (E suffix), 16-lead ceramic flat package (K suffix), and in chip form (H suffix).

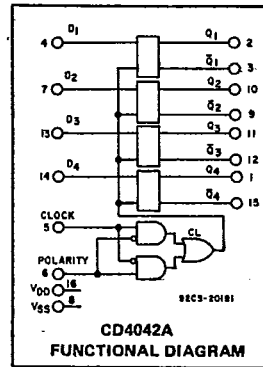

MAXIMUM RATINGS, Absolute-Maximum Values:

- STORAGE-TEMPERATURE RANGE (T_{stg}) -65 to +150°C
- OPERATING-TEMPERATURE RANGE (T_A):
- PACKAGE TYPES D, F, K, H -55 to +125°C
- PACKAGE TYPE E -40 to +85°C
- DC SUPPLY-VOLTAGE RANGE, (V_{DD})
- (Voltages referenced to V_{SS} Terminal): -0.5 to +15 V
- POWER DISSIPATION PER PACKAGE (P_D):
- FOR T_A = -40 to +60°C (PACKAGE TYPE E) 500 mW
- FOR T_A = +60 to +85°C (PACKAGE TYPE E) Derate Linearly at 12 mW/°C to 200 mW
- FOR T_A = -55 to +100°C (PACKAGE TYPES D, F, K) 500 mW
- FOR T_A = +100 to +125°C (PACKAGE TYPES D, F, K) Derate Linearly at 12 mW/°C to 200 mW
- DEVICE DISSIPATION PER OUTPUT TRANSISTOR
- FOR T_A = FULL PACKAGE-TEMPERATURE RANGE (ALL PACKAGE TYPES) 100 mW
- INPUT VOLTAGE RANGE, ALL INPUTS -0.5 to V_{DD} +0.5 V
- LEAD TEMPERATURE (DURING SOLDERING):
- At distance 1/16 ± 1/32 inch (1.69 ± 0.79 mm) from case for 10 s max +265°C

DYNAMIC ELECTRICAL CHARACTERISTICS at T_A = 25°C, Input t_r, t_f = 20 ns, C_L = 15 pF, R_L = 200 KΩ

CHARACTERISTIC	V _{DD} (V)	LIMITS				UNITS
		D, F, K, H Packages		E Package		
		Typ.	Max.	Typ.	Max.	
Propagation Delay Time: t _{PHL} , t _{PLH} Data In to Q	5 10	150 75	300 150	150 75	400 200	ns
Data In to Q̄	5 10	250 100	500 200	250 100	600 250	ns
Clock to Q	5 10	300 125	600 250	300 125	750 300	ns
Clock to Q̄	5 10	400 175	800 350	400 175	1000 400	ns
Transition Time: t _{THL} , t _{TLH}	5 10	100 50	200 100	100 50	300 150	ns
Minimum Clock Pulse Width, t _W	5 10	175 60	250 120	175 60	350 175	ns
Minimum Hold Time, t _H	5 10	150 60	300 120	150 60	350 150	ns
Minimum Setup Time, t _S	5 10	0 0	50 30	0 0	50 30	ns
Minimum Clock Rise or Fall Time: t _r , t _f	5 10	Not rise or fall time sensitive.				μs
Input Capacitance, C _i (Any Input)	-	5	-	5	-	pF

Features:

- Clock polarity control
- Q and Q̄ outputs
- Common clock
- Low power TTL compatible
- Quiescent current specified to 15 V
- Maximum input leakage of 1 μA at 15 V (full package-temperature range)
- 1-V noise margin (full package-temperature range)

Applications:

- Buffer storage
- Holding register
- General digital logic

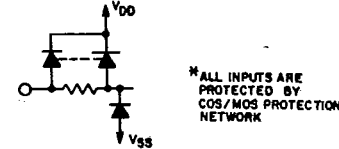
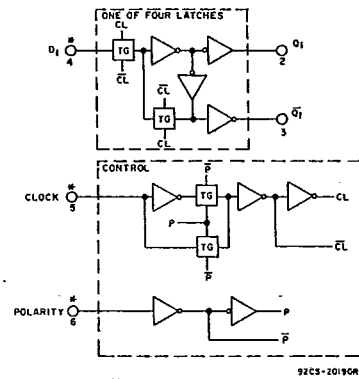

CLOCK	POLARITY	Q
0	0	D
1	0	LATCH
0	1	D
1	1	LATCH

Fig. 1 - Logic block diagram & truth table.

CD4042A Types

RECOMMENDED OPERATING CONDITIONS at $T_A = 25^\circ\text{C}$, Except as Noted.
For maximum reliability, nominal operating conditions should be selected so that operation is always within the following ranges:

CHARACTERISTIC	VDD (V)	LIMITS				UNITS
		D, F, K, H Packages		E Package		
		Min.	Max.	Min.	Max.	
Supply-Voltage Range (For $T_A = \text{Full Package Temperature Range}$)	—	3	12	3	12	V
Clock Pulse Width, t_W	5 10	350 175	—	250 120	—	ns
Setup Time, t_S	5 10	50 30	—	50 30	—	ns
Hold Time, t_H	5 10	350 150	—	300 120	—	ns
Clock Rise or Fall Time: t_r, t_f	5 10	Not rise or fall time sensitive.				μs

STATIC ELECTRICAL CHARACTERISTICS

Characteristic	Conditions			Limits at Indicated Temperatures ($^\circ\text{C}$)								Units
	VO (V)	VIN (V)	VDD (V)	D, F, K, H Packages				E Package				
				-55	+25		+125	-40	+25		+85	
Quiescent Device Current, I_L Max.	—	—	5	1	0.005	1	60	10	0.01	10	140	μA
	—	—	10	2	0.005	2	120	20	0.02	20	280	
	—	—	15	25	0.25	25	1000	250	2.5	250	2500	
Output Voltage: Low-Level, V_{OL}	—	0.5	5	0 Typ.; 0.05 Max.								V
	—	0.10	10	0 Typ.; 0.05 Max.								
	High Level, V_{OH}	—	0.5	5	4.95 Min.; 5 Typ.							
Noise Immunity: Inputs Low, V_{NL}	4.2	—	5	1.5 Min.; 2.25 Typ.								V
	9	—	10	3 Min.; 4.5 Typ.								
	Inputs High, V_{NH}	0.8	—	5	1.5 Min.; 2.25 Typ.							
Noise Margin: Inputs Low, V_{NML}	1	—	10	3 Min.; 4.5 Typ.								V
	4.5	—	5	1 Min.								
	Inputs High, V_{NMH}	0.5	—	5	1 Min.							
Output Drive Current: n-Channel (Sink), I_{DN} Min.	0.5	—	5	0.5	1	0.4	0.27	0.24	1	0.2	0.18	mA
	0.5	—	10	1.25	2	1	0.7	0.6	2	0.5	0.45	
p-Channel (Source), I_{DP} Min.	4.5	—	5	-0.45	-1	-0.35	-0.25	-0.2	-1	-0.175	-0.15	mA
	9.5	—	10	-1.15	-2	-0.9	-0.6	-0.34	-2	-0.45	-0.4	
Input Leakage Current, I_{IL}, I_{IH} Max.	Any Input		15	$\pm 10^{-5}$ Typ.; 1 Max.								μA

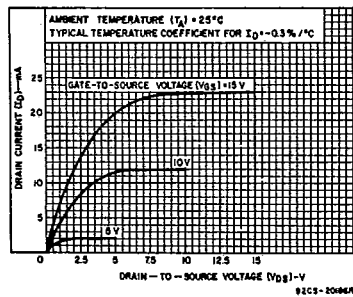

Fig. 2 - Typical output n-channel drain characteristics.

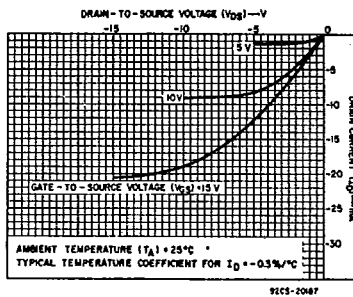

Fig. 3 - Typical output p-channel drain characteristics.

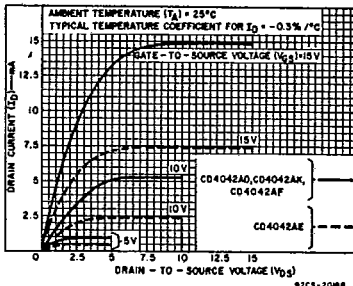

Fig. 4 - Minimum n-channel drain characteristics.

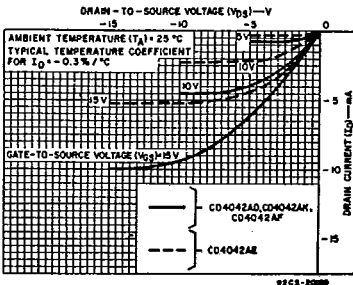
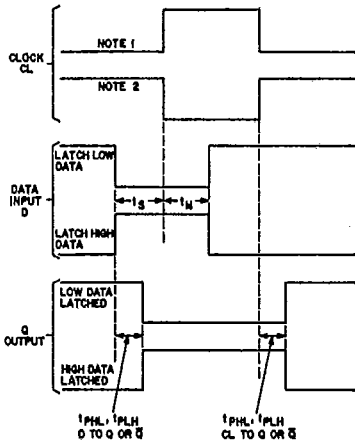

Fig. 5 - Minimum p-channel drain characteristics.

CD4042A Types



NOTES:
 1. FOR POSITIVE CLOCK EDGE, INPUT DATA IS LATCHED WHEN POLARITY IS LOW.
 2. FOR NEGATIVE CLOCK EDGE, INPUT DATA IS LATCHED WHEN POLARITY IS HIGH.

92CS-27630

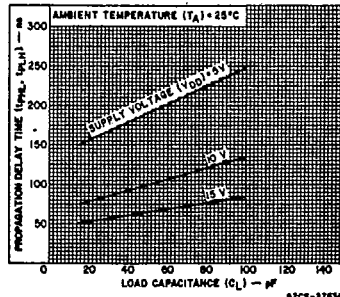

Fig. 7 - Typical propagation delay time vs. load capacitance - data to Q.

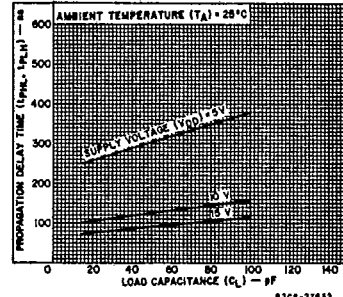

Fig. 8 - Typical propagation delay time vs. load capacitance - data to \bar{Q} .

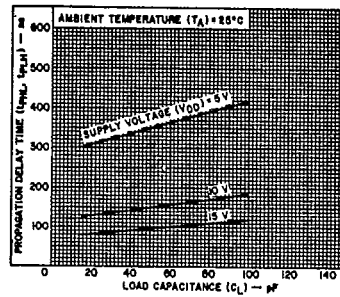

Fig. 9 - Typical propagation delay time vs. load capacitance - clock to Q.

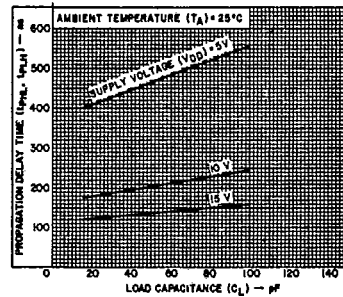

Fig. 10 - Typical propagation delay time vs. load capacitance - clock to \bar{Q} .

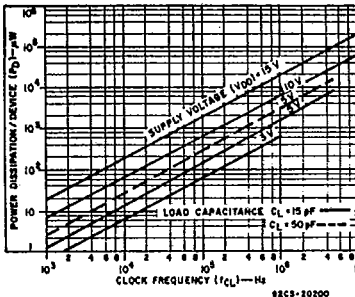

Fig. 11 - Typical dissipation characteristics.

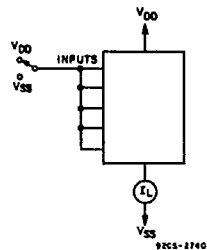

Fig. 12 - Quiescent device current test circuit.

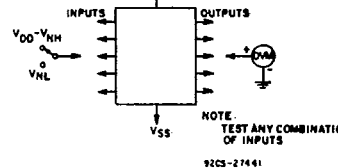

Fig. 13 - Noise immunity test circuit.

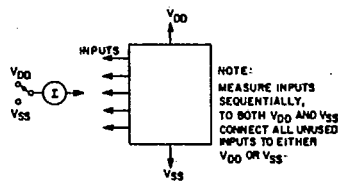
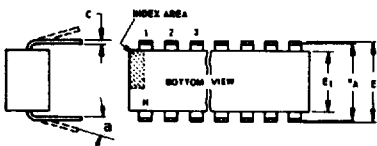
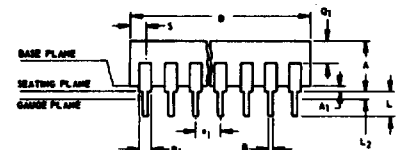

Fig. 14 - Input leakage current test circuit.

Dimensional Outlines

Dual-In-Line Welded-Seal Ceramic Packages



- NOTES:**
Refer to Rules for Dimensioning (JEDEC Publication No. 95) for Axial Lead Product Outlines.
- When this device is supplied solder-dipped, the maximum lead thickness (narrow portion) will not exceed 0.013" (0.33 mm).
 - Leads within 0.005" (0.12 mm) radius of True Position (TP) at gauge plane with maximum material condition and unit installed.
 - e_A applies in zone L₂ when unit installed.
 - a applies to spread leads prior to installation.
 - N is the maximum quantity of lead positions.
 - N₁ is the quantity of allowable missing leads.

(D) SUFFIX (JEDEC MO-001-AD)
14-Lead Dual-In-Line Welded-Seal Ceramic Package

SYMBOL	INCHES		NOTE	MILLIMETERS	
	MIN.	MAX.		MIN.	MAX.
A	0.120	0.160		3.05	4.06
A ₁	0.020	0.065		0.51	1.65
B	0.014	0.020		0.356	0.508
B ₁	0.060	0.065		1.27	1.65
C	0.008	0.012	1	0.204	0.304
D	0.745	0.770		18.93	19.55
E	0.300	0.325		7.62	8.25
E ₁	0.240	0.260		6.10	6.60
e ₁	0.100 TP		2	2.54 TP	
e _A	0.300 TP		2, 3	7.62 TP	
L	0.125	0.150		3.18	3.81
L ₂	0.000	0.030		0.000	0.76
a	0°	15°	4	0°	15°
N	14		5	14	
N ₁	0		6	0	
Q ₁	0.050	0.085		1.27	2.15
S	0.065	0.090		1.66	2.28

92SS-4411R2

(D) SUFFIX (JEDEC MO-001-AE)
16-Lead Dual-In-Line Welded-Seal Ceramic Package

SYMBOL	INCHES		NOTE	MILLIMETERS	
	MIN.	MAX.		MIN.	MAX.
A	0.120	0.160		3.05	4.06
A ₁	0.020	0.065		0.51	1.65
B	0.014	0.020		0.356	0.508
B ₁	0.035	0.065		0.89	1.65
C	0.008	0.012	1	0.204	0.304
D	0.745	0.785		18.93	19.93
E	0.300	0.325		7.62	8.25
E ₁	0.240	0.260		6.10	6.60
e ₁	0.100 TP		2	2.54 TP	
e _A	0.300 TP		2, 3	7.62 TP	
L	0.125	0.150		3.18	3.81
L ₂	0.000	0.030		0.000	0.76
a	0°	15°	4	0°	15°
N	16		5	16	
N ₁	0		6	0	
Q ₁	0.050	0.085		1.27	2.15
S	0.015	0.060		0.39	1.52

92SS-4266R5

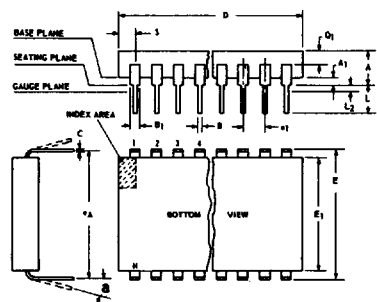

- NOTES:**
Refer to Rules for Dimensioning (JEDEC Publication No. 95) for Axial Lead Product Outlines.
- When this device is supplied solder-dipped, the maximum lead thickness (narrow portion) will not exceed 0.013" (0.33 mm).
 - Leads within 0.005" (0.12 mm) radius of True Position (TP) at gauge plane with maximum material condition and unit installed.
 - e_A applies in zone L₂ when unit installed.
 - a applies to spread leads prior to installation.
 - N is the maximum quantity of lead positions.
 - N₁ is the quantity of allowable missing leads.

(D) SUFFIX (JEDEC MO-015-AG)
24-Lead Dual-In-Line Welded-Seal Ceramic Package

SYMBOL	INCHES		NOTE	MILLIMETERS	
	MIN.	MAX.		MIN.	MAX.
A	0.090	0.200		2.29	5.08
A ₁	0.020	0.070		0.51	1.78
B	0.015	0.020		0.381	0.508
B ₁	0.045	0.055		1.143	1.397
C	0.008	0.012	1	0.204	0.304
D	1.15	1.22		29.21	30.98
E	0.600	0.625		15.24	15.87
E ₁	0.480	0.520		12.20	13.20
e ₁	0.100 TP		2	2.54 TP	
e _A	0.600 TP		2, 3	15.24 TP	
L	0.100	0.180		2.54	4.57
L ₂	0.000	0.030		0.00	0.76
a	0°	15°	4	0°	15°
N	24		5	24	
N ₁	0		6	0	
Q ₁	0.020	0.080		0.51	2.03
S	0.020	0.060		0.51	1.52

92CS-19948R4

(D) SUFFIX (JEDEC MO-015-AH)
28-Lead Dual-In-Line Welded-Seal Ceramic Package

SYMBOL	INCHES		NOTE	MILLIMETERS	
	MIN.	MAX.		MIN.	MAX.
A	0.090	0.200		2.29	5
A ₁	0	0.070	2	0	1.77
B	0.015	0.020		0.381	0.508
B ₁	0.015	0.065		0.39	1.39
C	0.008	0.012	1	0.204	0.304
D	1.380	1.420		35.06	36.06
E	0.600	0.625		15.24	15.87
E ₁	0.485	0.515		12.32	13.08
e ₁	0.100 TP		2	2.54 TP	
e _A	0.600 TP		2, 3	15.24 TP	
L	0.100	0.200		2.6	5
L ₂	0	0.030		0	0.76
a	0°	15°	4	0°	15°
N	28		5	28	
N ₁	0		6	0	
Q ₁	0.020	0.070		0.51	1.77
S	0.040	0.070		1.02	1.77

92CM-20250R2

TO-5 Style Package

(T) SUFFIX (JEDEC MO-006-AG)
12-Lead Metal Package

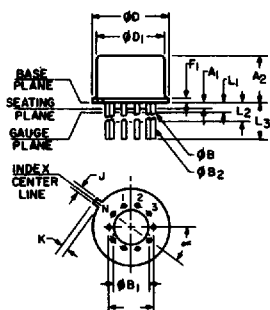

92CS-19774

SYMBOL	INCHES		NOTE	MILLIMETERS	
	MIN.	MAX.		MIN.	MAX.
a	0.230		2	5.84 TP	
A ₁	0	0		0	0
A ₂	0.165	0.185		4.19	4.70
φB	0.016	0.019	3	0.407	0.482
φB ₁	0	0		0	0
φB ₂	0.016	0.021	3	0.407	0.533
φD	0.335	0.370		8.51	9.39
φD ₁	0.305	0.335		7.75	8.50
F ₁	0.020	0.040		0.51	1.01
j	0.028	0.034		0.712	0.863
k	0.029	0.045	4	0.74	1.14
L ₁	0.000	0.050	3	0.00	1.27
L ₂	0.250	0.500	3	6.4	12.7
L ₃	0.500	0.562	3	12.7	14.27
a	30° TP			30° TP	
N	12		6	12	
N ₁	1		5	1	

NOTES:

- Refer to Rules for Dimensioning Axial Lead Product Outlines.
- Leads at gauge plane within 0.007" (0.178 mm) radius of True Position (TP) at maximum material condition.
- φB applies between L₁ and L₂. φB₂ applies between L₂ and 0.500" (12.70 mm) from seating plane. Diameter is uncontrolled in L₁ and beyond 0.500" (12.70 mm).
- Measure from Max. φD.
- N₁ is the quantity of allowable missing leads.
- N is the maximum quantity of lead positions.

Dimensional Outlines (Cont'd)

DUAL-IN-LINE SIDE-BRAZED CERAMIC PACKAGES

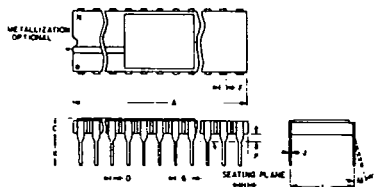

(D) SUFFIX
18-Lead Dual-In-Line
Side-Brazed Ceramic Package

SYMBOL	INCHES		NOTE	MILLIMETERS	
	MIN.	MAX.		MIN.	MAX.
A	0.890	0.915		22.606	23.241
C	—	0.200		—	5.080
D	0.015	0.021		0.381	0.533
F	0.054	REF.	1	1.371	REF.
G	0.100	BSC	1	2.54	BSC
H	0.035	0.065		0.889	1.651
J	0.008	0.012	3	0.203	0.304
K	0.125	0.150		3.175	3.810
L	0.290	0.310	2	7.366	7.874
M	—	15°		0°	15°
P	0.025	0.045		0.635	1.143
N	18			18	

92CS-27231R1

(D) SUFFIX
22-Lead Dual-In-Line
Side-Brazed Ceramic Package

SYMBOL	INCHES		NOTE	MILLIMETERS	
	MIN.	MAX.		MIN.	MAX.
A	1.065	1.100		27.05	27.94
C	0.085	0.145		2.16	3.68
D	0.017	0.023		0.43	0.58
F	0.040	REF.	1	1.02	REF.
G	0.100	BSC	1	2.54	BSC
H	0.030	0.070		0.76	1.78
J	0.008	0.012	3	0.20	0.30
K	0.125	0.175		3.18	4.45
L	0.380	0.420	2	9.65	10.67
M	—	7°		—	7°
P	0.025	0.050		0.64	1.27
N	22			22	

92CS-25186R2

NOTES:

- Leads within 0.005" (0.13 mm)-radius of True Position at maximum material condition.
- Dimension "L" to center of leads when formed parallel.
- When this device is supplied solder-dipped, the maximum lead thickness (narrow portion) will not exceed 0.013" (0.33 mm).

(D) SUFFIX
24-Lead Dual-In-Line
Side-Brazed Ceramic Package

SYMBOL	INCHES		NOTE	MILLIMETERS	
	MIN.	MAX.		MIN.	MAX.
A	1.180	1.220		29.98	30.98
C	0.085	0.145		2.16	3.68
D	0.015	0.023		0.39	0.58
F	0.040	REF.		1.02	REF.
G	0.100	BSC	1	2.54	BSC
H	0.030	0.070		0.77	1.77
J	0.008	0.012	3	0.21	0.30
K	0.125	0.175		3.18	4.44
L	0.580	0.620	2	14.74	15.74
M	—	7°		—	7°
P	0.025	0.050		0.64	1.27
N	24			24	

92CS-30968R1

(D) SUFFIX
40-Lead Dual-In-Line
Side-Brazed Ceramic Package

SYMBOL	INCHES		NOTE	MILLIMETERS	
	MIN.	MAX.		MIN.	MAX.
A	1.980	2.020		50.30	51.30
C	0.095	0.155		2.43	3.93
D	0.017	0.023		0.43	0.58
F	0.050	REF.		1.27	REF.
G	0.100	BSC	1	2.54	BSC
H	0.030	0.070		0.76	1.78
J	0.008	0.012	3	0.20	0.30
K	0.125	0.175		3.18	4.45
L	0.580	0.620	2	14.74	15.74
M	—	7°		—	7°
P	0.025	0.050		0.64	1.27
N	40			40	

92CM-27029R2

Dual-In-Line Plastic and Frit-Seal Ceramic Packages

(E) SUFFIX (JEDEC MO-001-AN)
8-Lead Dual-In-Line Plastic
(Mini-DIP) Package

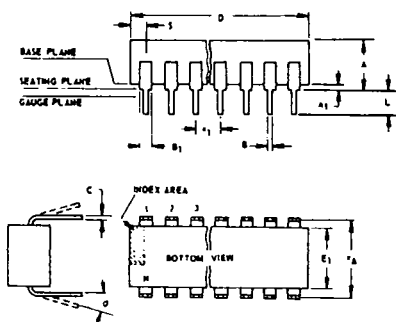

SYMBOL	INCHES		NOTE	MILLIMETERS	
	MIN.	MAX.		MIN.	MAX.
A	0.155	0.200		3.94	5.08
A ₁	0.020	0.050		0.508	1.27
B	0.014	0.020		0.356	0.508
B ₁	0.035	0.065		0.889	1.65
C	0.008	0.012	1	0.203	0.304
D	0.370	0.400		9.40	10.16
E	0.300	0.325		7.62	8.25
E ₁	0.240	0.260		6.10	6.60
e ₁	0.100	TP	2	2.54	TP
e _A	0.300	TP	2, 3	7.62	TP
L	0.125	0.150		3.18	3.81
L ₂	0.000	0.030		0.000	0.762
a	0	15	4	0	15
N	8		5	8	
N ₁	0		6	0	
O ₁	0.040	0.075		1.02	1.90
S	0.015	0.060		0.381	1.52

92CS-24026 R1

NOTES:

- Refer to Rules for Dimensioning (JEDEC Publication No. 95) for Axial Lead Product Outlines.
- When this device is supplied solder-dipped, the maximum lead thickness (narrow portion) will not exceed 0.013".
 - Leads within 0.005" (0.12 mm) radius of True Position (TP) at gauge plane with maximum material condition and unit installed.
 - e_A applies in zone L₂ when unit installed.
 - a applies to spread leads prior to installation.
 - N is the maximum quantity of lead positions.
 - N₁ is the quantity of allowable missing leads.

Dimensional Outlines (Cont'd)

Dual-In-Line Plastic and Frit-Seal Ceramic Packages (Cont'd)

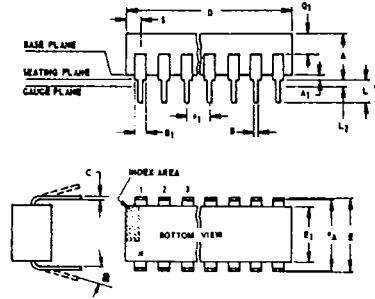

NOTES:
Refer to Rules for Dimensioning (JEDEC Publication No. 95) for Axial Lead Product Outlines.
1. When this device is supplied solder dipped, the maximum lead thickness (narrow portion) will not exceed 0.013" (0.33 mm).
2. Leads within 0.005" (0.12 mm) radius of True Position (TP) at gauge plane with maximum material condition and unit installed.
3. eA applies in zone L2 when unit installed.
4. alpha applies to spread leads prior to installation.
5. N is the maximum quantity of lead positions.
6. N1 is the quantity of allowable missing leads.

(E) and (F) SUFFIXES (JEDEC MO-001-AB)
14-Lead Dual-In-Line Plastic or Frit-Seal Ceramic Package

SYMBOL	INCHES		NOTE	MILLIMETERS	
	MIN.	MAX.		MIN.	MAX.
A	0.155	0.200		3.94	5.08
A ₁	0.020	0.050		0.51	1.27
B	0.014	0.020		0.356	0.508
B ₁	0.050	0.065		1.27	1.65
C	0.008	0.012	1	0.204	0.304
D	0.745	0.770		18.93	19.55
E	0.300	0.325		7.62	8.25
E ₁	0.240	0.260		6.10	6.60
e ₁	0.100 TP		2	2.54 TP	
e _A	0.300 TP		2, 3	7.62 TP	
L	0.125	0.150		3.18	3.81
L ₂	0.000	0.030		0.000	0.76
a	0°	15°	4	0°	15°
N	14		5	14	
N ₁	0		6	0	
Q ₁	0.040	0.075		1.02	1.90
S	0.065	0.090		1.66	2.28

92SS-4296R3

(E) and (F) SUFFIXES (JEDEC MO-001-AC)
16-Lead Dual-In-Line Plastic or Frit-Seal Ceramic Package

SYMBOL	INCHES		NOTE	MILLIMETERS	
	MIN.	MAX.		MIN.	MAX.
A	0.155	0.200		3.94	5.08
A ₁	0.020	0.050		0.51	1.27
B	0.014	0.020		0.356	0.508
B ₁	0.035	0.065		0.89	1.65
C	0.008	0.012	1	0.204	0.304
D	0.745	0.785		18.93	19.93
E	0.300	0.325		7.62	8.25
E ₁	0.240	0.260		6.10	6.60
e ₁	0.100 TP		2	2.54 TP	
e _A	0.300 TP		2, 3	7.62 TP	
L	0.125	0.150		3.18	3.81
L ₂	0.000	0.030		0.000	0.76
a	0°	15°	4	0°	15°
N	16		5	16	
N ₁	0		6	0	
Q ₁	0.040	0.075		1.02	1.90
S	0.015	0.060		0.39	1.52

92CM-15967R4

(E) SUFFIX
18-Lead Dual-In-Line Plastic Package

SYMBOL	INCHES		NOTE	MILLIMETERS	
	MIN.	MAX.		MIN.	MAX.
A	0.155	0.200		3.94	5.08
A ₁	0.020	0.050		0.508	1.27
B	0.014	0.020		0.356	0.508
B ₁	0.035	0.065		0.89	1.65
C	0.008	0.012	1	0.204	0.304
D	0.845	0.885		21.47	22.47
E ₁	0.240	0.260		6.10	6.60
e ₁	0.100 TP		2	2.54 TP	
e _A	0.300 TP		2, 3	7.62 TP	
L	0.125	0.150		3.18	3.81
a	0°	15°	4	0°	15°
N	18		5	18	
N ₁	0		6	0	
S	0.015	0.060		0.39	1.52

92CS-30630

(E) SUFFIX
22-Lead Dual-In-Line Plastic Package

SYMBOL	INCHES		NOTE	MILLIMETERS	
	MIN.	MAX.		MIN.	MAX.
A	0.155	0.200		3.94	5.08
A ₁	0.020	0.050		0.508	1.27
B	0.015	0.020		0.381	0.508
B ₁	0.035	0.065		0.89	1.65
C	0.008	0.012	1	0.204	0.304
D		1.120			28.44
E	0.390	0.420		9.91	10.66
E ₁	0.345	0.355		8.77	9.01
e ₁	0.100 TP		2	2.54 TP	
e _A	0.400 TP		2, 3	10.16 TP	
L	0.125	0.150		3.18	3.81
L ₂	0	0.030		0	0.762
a	2°	15°	4	2°	15°
N	22		5	22	
N ₁	0		6	0	
Q ₁	0.055	0.085		1.40	2.15
S	0.015	0.060		0.381	1.27

92CS-30830

(F) SUFFIX (JEDEC MO-001-AG)
16-Lead Dual-In-Line Frit-Seal Ceramic Package

SYMBOL	INCHES		NOTE	MILLIMETERS	
	MIN.	MAX.		MIN.	MAX.
A	0.165	0.210		4.20	5.33
A ₁	0.015	0.045		0.381	1.14
B	0.015	0.020		0.381	0.508
B ₁	0.045	0.070		1.15	1.77
C	0.009	0.011	1	0.229	0.279
D	0.750	0.795		19.05	20.19
E	0.295	0.325		7.50	8.25
E ₁	0.245	0.300		6.23	7.62
e ₁	0.100 TP		2	2.54 TP	
e _A	0.300 TP		2, 3	7.62 TP	
L	0.120	0.160		3.05	4.06
L ₂	0.000	0.030		0.000	0.76
a	2°	15°	4	2°	15°
N	16		5	16	
N ₁	0		6	0	
Q ₁	0.050	0.080		1.27	2.03
S	0.010	0.060		0.254	1.52

92CM-22284R1

(E) and (F) SUFFIXES (JEDEC MO-015-AA)
24-Lead Dual-In-Line Plastic or Frit-Seal Ceramic Package

SYMBOL	INCHES		NOTE	MILLIMETERS	
	MIN.	MAX.		MIN.	MAX.
A	0.120	0.250		3.10	6.30
A ₁	0.020	0.070		0.51	1.77
B	0.016	0.020		0.407	0.508
B ₁	0.028	0.070		0.72	1.77
C	0.008	0.012	1	0.204	0.304
D	1.20	1.29		30.48	32.76
E	0.600	0.625		15.24	15.87
E ₁	0.515	0.580		13.09	14.73
e ₁	0.100 TP		2	2.54 TP	
e _A	0.600 TP		2, 3	15.24 TP	
L	0.100	0.200		2.54	5.00
L ₂	0.000	0.030		0.00	0.76
a	0°	15°	4	0°	15°
N	24		5	24	
N ₁	0		6	0	
Q ₁	0.040	0.075		1.02	1.90
S	0.040	0.100		1.02	2.54

92CS26938R2

(E) SUFFIX
40-Lead Dual-In-Line Plastic Package

SYMBOL	INCHES		NOTE	MILLIMETERS	
	MIN.	MAX.		MIN.	MAX.
A	0.120	0.250		3.10	6.30
A ₁	0.020	0.070		0.51	1.77
B	0.016	0.020		0.407	0.508
B ₁	0.028	0.070		0.72	1.77
C	0.008	0.012	1	0.204	0.304
D	2.000	2.090		50.80	53.09
E ₁	0.515	0.580		13.09	14.73
e ₁	0.100 TP		2	2.54 TP	
e _A	0.600 TP		2, 3	15.24 TP	
L	0.100	0.200		2.54	5.00
L ₂	0.000	0.030		0.00	0.76
a	0°	15°	4	0°	15°
N	40		5	40	
N ₁	0		6	0	
Q ₁	0.065	0.095		1.66	2.41
S	0.040	0.100		1.02	2.54

92CS-30959

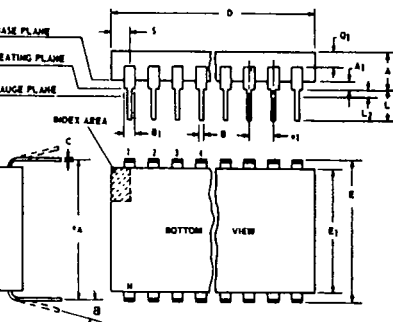

NOTES:
Refer to Rules for Dimensioning (JEDEC Publication No. 95) for Axial Lead Product Outlines.
1. When this device is supplied solder dipped, the maximum lead thickness (narrow portion) will not exceed 0.013".
2. Leads within 0.005" (0.12 mm) radius of True Position (TP) at gauge plane with maximum material condition and unit installed.
3. eA applies in zone L2 when unit installed.
4. alpha applies to spread leads prior to installation.
5. N is the maximum quantity of lead positions.
6. N1 is the quantity of allowable missing leads.

T-90-20

Dimensional Outlines (Cont'd)

Ceramic Flat Packs

(K) SUFFIX (JEDEC MO-004-AF)
14-Lead

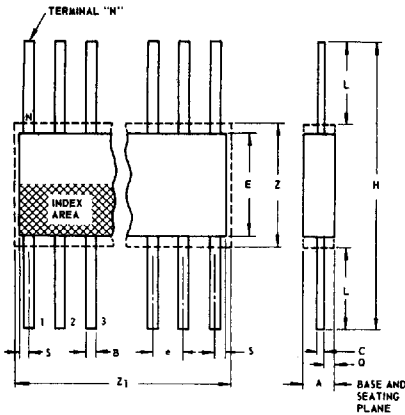

SYMBOL	INCHES		NOTE	MILLIMETERS	
	MIN.	MAX.		MIN.	MAX.
A	0.008	0.100		0.21	2.54
B	0.015	0.019	1	0.381	0.482
C	0.003	0.006	1	0.077	0.152
e	0.050 TP		2	1.27 TP	
E	0.200	0.300		5.1	7.6
H	0.600	1.000		15.3	25.4
L	0.150	0.350		3.9	8.8
N	14		3	14	
Q	0.005	0.050		0.13	1.27
S	0.000	0.050		0.00	1.27
Z	0.300		4	7.62	
Z ₁	0.400		4	10.16	

92SS-4300R3

NOTES:

1. Refer to JEDEC Publication No. 95 for Rules for Dimensioning Peripheral Lead Outlines.
2. Leads within 0.005" (0.12 mm) radius of True Position (TP) at maximum material condition.
3. N is the maximum quantity of lead positions.
4. Z and Z₁ determine a zone within which all body and lead irregularities lie.

(K) SUFFIX (JEDEC MO-004-AG)
16-Lead

SYMBOL	INCHES		NOTE	MILLIMETERS	
	MIN.	MAX.		MIN.	MAX.
A	0.008	0.100		0.21	2.54
B	0.015	0.019	1	0.381	0.482
C	0.003	0.006	1	0.077	0.152
e	0.050 TP		2	1.27 TP	
E	0.200	0.300		5.1	7.6
H	0.600	1.000		15.3	25.4
L	0.150	0.350		3.9	8.8
N	16		3	16	
Q	0.005	0.050		0.13	1.27
S	0.000	0.025		0.00	0.63
Z	0.300		4	7.62	
Z ₁	0.400		4	10.16	

92CS-17271R3

(K) SUFFIX
24-Lead

SYMBOL	INCHES		NOTE	MILLIMETERS	
	MIN.	MAX.		MIN.	MAX.
A	0.075	0.120		1.91	3.04
B	0.018	0.022	1	0.458	0.558
C	0.004	0.007	1	0.102	0.177
e	0.050 TP		2	1.27 TP	
E	0.600	0.700		15.24	17.78
H	1.150	1.350		29.21	34.29
L	0.225	0.325		5.72	8.25
N	24		3	24	
Q	0.035	0.070		0.89	1.77
S	0.060	0.110	1	1.53	2.79
Z	0.700		4	17.78	
Z ₁	0.750		4	19.05	

92CS-19949R2

(K) SUFFIX
28-Lead

SYMBOL	INCHES		NOTE	MILLIMETERS	
	MIN.	MAX.		MIN.	MAX.
A	0.075	0.120		1.91	3.04
B	0.018	0.022	1	0.458	0.558
C	0.004	0.007	1	0.102	0.177
e	0.050 TP		2	1.27 TP	
E	0.600	0.700		15.24	17.78
H	1.150	1.350		29.21	34.29
L	0.225	0.325		5.72	8.25
N	28		3	28	
Q	0.035	0.070		0.89	1.77
S	0	0.060	1	0	1.53
Z	0.700		4	17.78	
Z ₁	0.750		4	19.05	

92CS-20972