

T-45-23-21

CD4017A Types

CMOS Decade Counter/Divider

Plus 10 Decoded Decimal Outputs

The RCA-CD4017A consists of a 5-stage Johnson decade counter and an output decoder which converts the Johnson binary code to a decimal number. Inputs include a CLOCK, a RESET, and a CLOCK INHIBIT signal.

The decade counter is advanced one count at the positive clock signal transition if the CLOCK INHIBIT signal is low. Counter advancement via the clock line is inhibited when the clock INHIBIT signal is high. A high reset signal clears the decade counter to

its zero count. Use of the Johnson decade counter configuration permits high speed operation, 2-input decimal decode gating, and spike-free decoded outputs. Anti-lock gating is provided, thus assuring proper counting sequence. The 10 decoded outputs are normally low and go high only at their respective decimal time slot. Each decoded output remains high for one full clock cycle. A CARRY-OUT (COUT) signal completes one cycle every 10 clock input cycles and is used to clock the succeeding decade directly in a multi-decade counting chain.

These types are supplied in 16-lead hermetic dual-in-line ceramic packages (D and F suffixes), 16-lead dual-in-line plastic packages (E suffix), 16-lead ceramic flat packages (K suffix), and in chip form (H suffix).

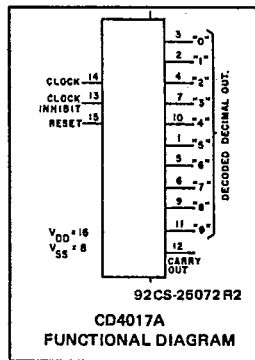

MAXIMUM RATINGS, Absolute-Maximum Values:

STORAGE-TEMPERATURE RANGE (T _{stg})	-65 to +150°C
OPERATING-TEMPERATURE RANGE (T _A):	
PACKAGE TYPES D, F, K, H	-55 to +125°C
PACKAGE TYPE E	-40 to +85°C
DC SUPPLY-VOLTAGE RANGE (V _{DD})	
(Voltages referenced to V _{SS} Terminal)	-0.5 to +15 V
POWER DISSIPATION PER PACKAGE (P _D):	
FOR T _A = -40 to +60°C (PACKAGE TYPE E)	500 mW
FOR T _A = +60 to +85°C (PACKAGE TYPE E)	Derate Linearly at 12 mW/°C to 200 mW
FOR T _A = -55 to +100°C (PACKAGE TYPES D, F, K)	500 mW
FOR T _A = +100 to +125°C (PACKAGE TYPES D, F, K)	Derate Linearly at 12 mW/°C to 200 mW
DEVICE DISSIPATION PER OUTPUT TRANSISTOR	
FOR T _A = FULL PACKAGE-TEMPERATURE RANGE (ALL PACKAGE TYPES)	100 mW
INPUT VOLTAGE RANGE, ALL INPUTS	-0.5 to V _{DD} +0.5 V
LEAD TEMPERATURE (DURING SOLDERING):	
At distance 1/16 ± 1/32 inch (1.59 ± 0.79 mm) from case for 10 s max.	+265°C

Features:

- Synchronous decade counter plus 10 decoded outputs
- Fully static operation
- Medium speed operation... 5 MHz (typ.) at V_{DD} - V_{SS} = 10 V
- Quiescent current specified to 15 V
- Maximum input leakage current of 1 µA at 15 V (full package-temperature range)
- 1-V noise margin (full package-temperature range)

Applications:

- Decade counter/decimal decode display
- Frequency division
- Counter control/timers
- Divide by N counting
 - N = 2 - 10 with one CD4017A and one one CD4001A
 - N > 10 with multiple CD4017A's
- For further application information, see ICAN-6166 "CMOS MSI Counter and Register Design & Applications"

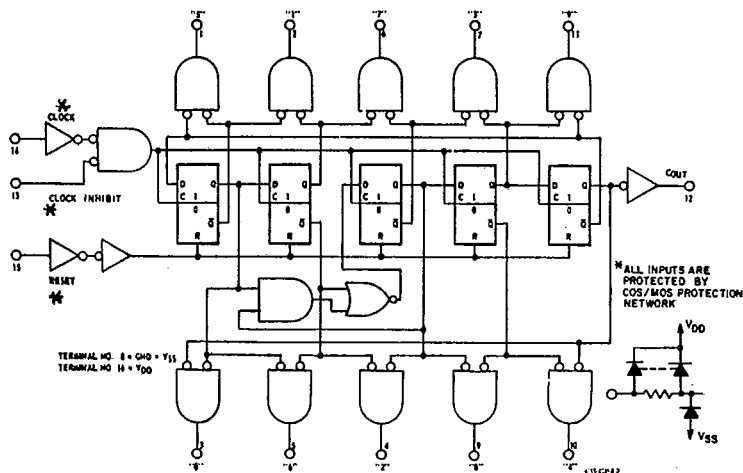

Fig. 1 - Logic diagram.

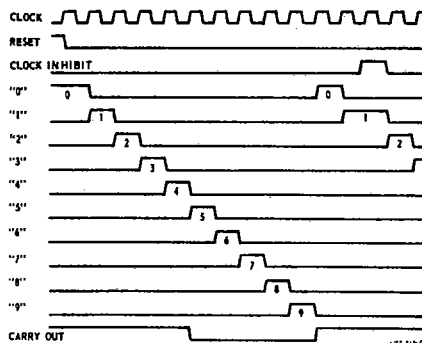

Fig. 2 - Timing diagram.

CD4017A Types

STATIC ELECTRICAL CHARACTERISTICS

CHARACTERISTICS	CONDITIONS			LIMITS AT INDICATED TEMPERATURES (°C)								UNITS	
	V _O (V)	V _{IN} (V)	V _{DD} (V)	D, F, K, H PACKAGES				E PACKAGE					
				-55	+25		+125	-40	+25		+85		
Quiescent Device Current, I _L Max.	-	-	5	5	0.3	5	300	50	0.5	50	700	μA	
	-	-	10	10	0.5	10	600	100	1	100	1400		
	-	-	15	50	1	50	2000	500	5	500	5000		
Output Voltage: Low-Level, V _{OL}	-	5	5	0 Typ.; 0.05 Max.								V	
	-	10	10	0 Typ.; 0.05 Max.									
	-	0	5	4.95 Min.; 5 Typ.									
High Level V _{OH}	-	0	5	9.95 Min.; 10 Typ.								V	
	-	0	10	9.95 Min.; 10 Typ.									
Noise Immunity: Inputs Low, V _{NL}	4.2	-	5	1.5 Min.; 2.25 Typ.								V	
	9	-	10	3 Min.; 4.5 Typ.									
Inputs High V _{NH}	0.8	-	5	1.5 Min.; 2.25 Typ.								V	
	1	-	10	3 Min.; 4.5 Typ.									
Noise Margin Inputs Low V _{NML}	4.5	-	5	1 Min.								V	
	9	-	10	1 Min.									
Inputs High, V _{NMH}	0.5	-	5	1 Min.								V	
	1	-	10	1 Min.									
Output Drive Current: N-Channel (Sink)													
	I _{DN} Min	Decoded Outputs	0.5	-	5	0.08	0.1	0.05	0.035	0.03	0.1	0.025	0.02
Carry Output		0.5	-	5	0.185	0.4	0.16	0.105	0.095	0.4	0.08	0.065	
P-Channel (Source)													
	I _{DP} Min	Decoded Outputs	4.5	-	5	-0.0375	-0.075	-0.03	-0.021	-0.018	-0.075	-0.015	-0.012
Carry Output		4.5	-	5	-0.185	-0.4	-0.16	-0.105	-0.095	-0.4	-0.08	-0.065	
Input Leakage Current, I _{IL} , I _{IH}													
	Any Input	-	-	15	±10 ⁻⁵ Typ., ±1 Max.								μA

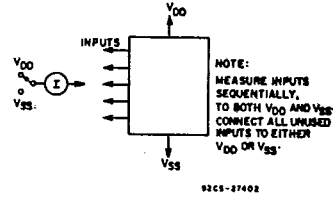

Fig. 10 - Input-leakage-current test circuit.

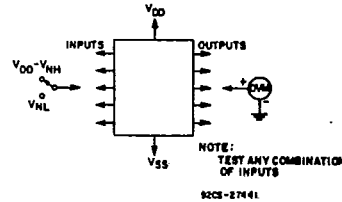

Fig. 11 - Noise-immunity test circuit.

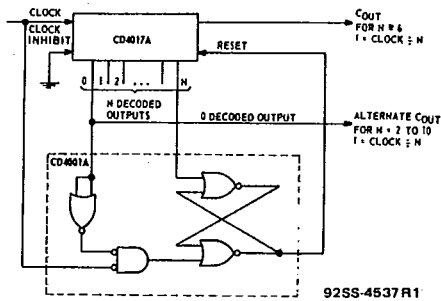

Fig. 12 - Divide by N counter (N ≤ 10) with N decoded outputs.

When the Nth decoded output is reached (Nth clock pulse) the S-R flip flop (constructed from two NOR gates of the CD4001A) generates a reset pulse which clears the CD4017A to its zero count. At this time, if the Nth decoded output is greater than or equal to 6, the COUT line goes high to clock the next CD4017A counter section. The "0" decoded output also goes high at this time. Coincidence of the clock low and decoded "0" output low resets the S-R flip flop to enable the CD4017A. If the Nth decoded output is less than 6, the COUT line will not go high and, therefore, cannot be used. In this case "0" decoded output may be used to perform the clocking function for the next counter.

CD4017A Types

RECOMMENDED OPERATING CONDITIONS at $T_A = 25^\circ\text{C}$, Except as Noted.
For maximum reliability, nominal operating conditions should be selected so that operation is always within the following ranges:

CHARACTERISTIC	VDD (V)	LIMITS				UNITS
		D, F, K, H PACKAGES		E PACKAGE		
		MIN.	MAX.	MIN.	MAX.	
Supply Voltage Range (For $T_A = \text{Full Package-Temperature Range}$)		3	12	3	12	V
Clock Inhibit Setup Time, t_S	5 10	500 200	—	700 300	—	ns
Clock Pulse Width, t_W	5 10	500 170	—	830 250	—	ns
Clock Input Frequency, f_{CL}	5 10	dc dc	1 3	dc dc	0.6 2	MHz
Clock Rise or Fall Time, t_{rCL} , t_{fCL}	5 10	— —	15 15	— —	15 15	μs
Reset Pulse Width, t_W	5 10	500 165	—	830 250	—	ns
Reset Removal Time	5 10	750 225	—	1000 275	—	ns

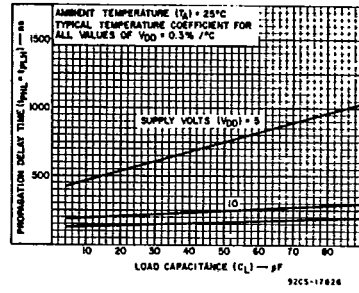

Fig. 3 - Typical propagation delay time vs. C_L for decoded outputs.

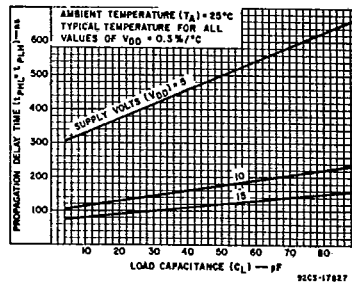

Fig. 4 - Typical propagation delay time vs. C_L for carry output.

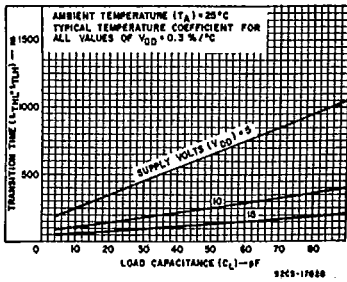

Fig. 5 - Typical transition time vs. C_L for decoded outputs.

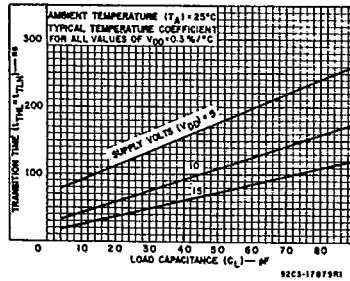

Fig. 6 - Typical transition time vs. C_L for carry output.

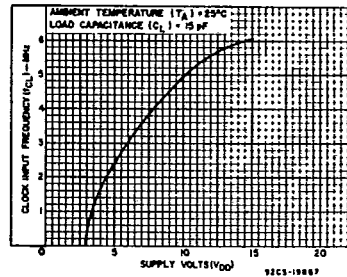

Fig. 7 - Typical clock input frequency vs. V_{DD} .

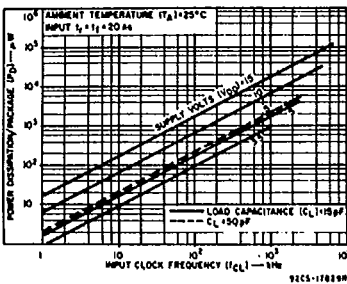

Fig. 8 - Typical dissipation characteristics.

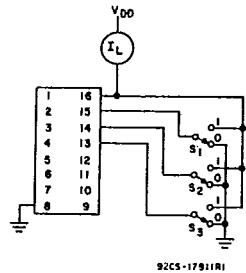

Fig. 9 - Quiescent device current test circuit.

Test performed with the following sequence of "1's" and "0's" at each switch.

S1	S2	S3	S1	S2	S3
1	1	1	0	1	0
0	0	0	0	0	0
0	1	0	0	1	0
0	0	0	0	0	0
0	0	0	0	0	0
0	1	0	0	1	0
0	0	0	0	0	0
0	0	0	0	1	0

CD4017A Types

DYNAMIC ELECTRICAL CHARACTERISTICS

At $T_A = 25^\circ\text{C}$, Input $t_r, t_f = 20 \text{ ns}$, $C_L = 15 \text{ pF}$, $R_L = 200 \text{ k}\Omega$

CHARACTERISTIC	TEST CONDITIONS	LIMITS						UNITS	
		VDD (V)	D, F, K, H PACKAGES			E PACKAGE			
			MIN.	TYP.	MAX.	MIN.	TYP.		MAX.
CLOCKED OPERATION									
Propagation Delay Time; t_{PHL}, t_{PLH}		5	-	350	1000	-	350	1300	ns
		10	-	125	250	-	125	300	
Carry Out Line		5	-	500	1200	-	500	1600	ns
Decode Out Lines		10	-	200	400	-	200	500	
Transition Time; t_{THL}, t_{TLH}		5	-	100	300	-	100	350	ns
		10	-	50	150	-	50	200	
Carry Out Line		5	-	300	900	-	300	1200	ns
		10	-	125	350	-	125	450	
Decode Out Lines		5	-	300	900	-	300	1200	ns
		10	-	125	350	-	125	450	
Maximum Clock Input Frequency, f_{CL}^*		5	1	2.5	-	0.6	2.5	-	MHz
		10	3	5	-	2	5	-	
Minimum Clock Pulse Width, t_W		5	-	200	500	-	200	830	ns
		10	-	100	170	-	100	250	
Clock Rise & Fall Time; t_{rCL}, t_{fCL}		5	-	-	15	-	-	15	μs
		10	-	-	15	-	-	15	
Minimum Clock Inhibit Set-Up Time, t_s		5	-	175	500	-	175	700	ns
		10	-	75	200	-	75	300	
Average Input Capacitance, C_i	Any Input	-	5	-	-	5	-	pF	
RESET OPERATION									
Propagation Delay Time; t_{PHL}		5	-	350	1000	-	350	1300	ns
		10	-	125	250	-	125	300	
To Carry Out Line		5	-	450	1200	-	450	1600	ns
To Decode Out Lines		10	-	200	400	-	200	500	
Minimum Reset Pulse Width, t_W		5	-	200	500	-	200	830	ns
		10	-	100	165	-	100	250	
Minimum Reset Removal Time		5	-	300	750	-	300	1000	ns
		10	-	100	225	-	100	275	

*Measured with respect to carry output line

Dimensional Outlines

Dual-In-Line Welded-Seal Ceramic Packages

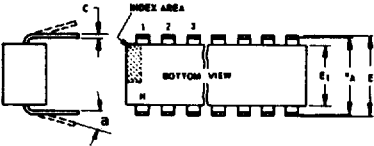
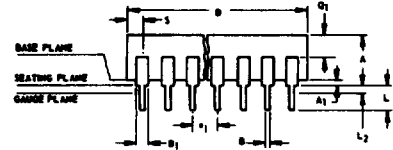

NOTES:
Refer to Rules for Dimensioning (JEDEC Publication No. 95) for Axial Lead Product Outlines.

- When this device is supplied solder-dipped, the maximum lead thickness (narrow portion) will not exceed 0.013" (0.33 mm).
- Leads within 0.005" (0.12 mm) radius of True Position (TP) at gauge plane with maximum material condition and unit installed.
- e_A applies in zone L_2 when unit installed.
- a applies to spread leads prior to installation.
- N is the maximum quantity of lead positions.
- N_1 is the quantity of allowable missing leads.

(D) SUFFIX (JEDEC MO-001-AD)
14-Lead Dual-In-Line Welded-Seal Ceramic Package

SYMBOL	INCHES		NOTE	MILLIMETERS	
	MIN.	MAX.		MIN.	MAX.
A	0.120	0.160		3.05	4.06
A ₁	0.020	0.065		0.51	1.65
B	0.014	0.020		0.356	0.508
B ₁	0.060	0.065		1.27	1.65
C	0.008	0.012	1	0.204	0.304
D	0.745	0.770		18.93	19.55
E	0.300	0.325		7.62	8.25
E ₁	0.240	0.260		6.10	6.60
e_1	0.100 TP		2	2.54 TP	
e_A	0.300 TP		2, 3	7.62 TP	
L	0.125	0.150		3.18	3.81
L ₂	0.000	0.030		0.000	0.76
a	0°	15°	4	0°	15°
N	14		5	14	
N ₁	0		6	0	
Q ₁	0.050	0.085		1.27	2.15
S	0.065	0.090		1.66	2.28

92SS-4411R2

(D) SUFFIX (JEDEC MO-001-AE)
16-Lead Dual-In-Line Welded-Seal Ceramic Package

SYMBOL	INCHES		NOTE	MILLIMETERS	
	MIN.	MAX.		MIN.	MAX.
A	0.120	0.160		3.05	4.06
A ₁	0.020	0.065		0.51	1.65
B	0.014	0.020		0.356	0.508
B ₁	0.035	0.065		0.89	1.65
C	0.008	0.012	1	0.204	0.304
D	0.745	0.785		18.93	19.93
E	0.300	0.325		7.62	8.25
E ₁	0.240	0.260		6.10	6.60
e_1	0.100 TP		2	2.54 TP	
e_A	0.300 TP		2, 3	7.62 TP	
L	0.125	0.150		3.18	3.81
L ₂	0.000	0.030		0.000	0.76
a	0°	15°	4	0°	15°
N	16		5	16	
N ₁	0		6	0	
Q ₁	0.050	0.085		1.27	2.15
S	0.015	0.060		0.39	1.52

92SS-4266R5

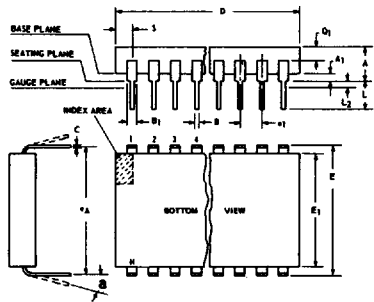

NOTES:
Refer to Rules for Dimensioning (JEDEC Publication No. 95) for Axial Lead Product Outlines.

- When this device is supplied solder-dipped, the maximum lead thickness (narrow portion) will not exceed 0.013" (0.33 mm).
- Leads within 0.005" (0.12 mm) radius of True Position (TP) at gauge plane with maximum material condition and unit installed.
- e_A applies in zone L_2 when unit installed.
- a applies to spread leads prior to installation.
- N is the maximum quantity of lead positions.
- N_1 is the quantity of allowable missing leads.

(D) SUFFIX (JEDEC MO-015-AG)
24-Lead Dual-In-Line Welded-Seal Ceramic Package

SYMBOL	INCHES		NOTE	MILLIMETERS	
	MIN.	MAX.		MIN.	MAX.
A	0.090	0.200		2.29	5.08
A ₁	0.020	0.070		0.51	1.78
B	0.015	0.020		0.381	0.508
B ₁	0.045	0.055		1.143	1.397
C	0.008	0.012	1	0.204	0.304
D	1.15	1.22		29.21	30.98
E	0.600	0.625		15.24	15.87
E ₁	0.480	0.520		12.20	13.20
e_1	0.100 TP		2	2.54 TP	
e_A	0.600 TP		2, 3	15.24 TP	
L	0.100	0.180		2.54	4.57
L ₂	0.000	0.030		0.00	0.76
a	0°	15°	4	0°	15°
N	24		5	24	
N ₁	0		6	0	
Q ₁	0.020	0.080		0.51	2.03
S	0.020	0.060		0.51	1.52

92CS-19948R4

(D) SUFFIX (JEDEC MO-015-AH)
28-Lead Dual-In-Line Welded-Seal Ceramic Package

SYMBOL	INCHES		NOTE	MILLIMETERS	
	MIN.	MAX.		MIN.	MAX.
A	0.090	0.200		2.29	5
A ₁	0	0.070	2	0	1.77
B	0.015	0.020		0.381	0.508
B ₁	0.015	0.065		0.39	1.39
C	0.008	0.012	1	0.204	0.304
D	1.380	1.420		35.06	36.06
E	0.600	0.625		15.24	15.87
E ₁	0.485	0.515		12.32	13.08
e_1	0.100 TP		2	2.54 TP	
e_A	0.600 TP		2, 3	15.24 TP	
L	0.100	0.200		2.6	5
L ₂	0	0.030		0	0.76
a	0°	15°	4	0°	15°
N	28		5	28	
N ₁	0		6	0	
Q ₁	0.020	0.070		0.51	1.77
S	0.040	0.070		1.02	1.77

92CM-20250R2

TO-5 Style Package

(T) SUFFIX (JEDEC MO-006-AG)
12-Lead Metal Package

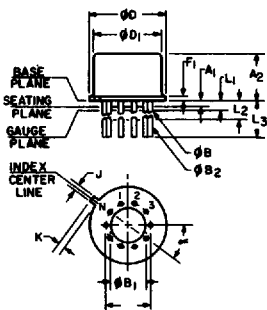

92CS-19774

SYMBOL	INCHES		NOTE	MILLIMETERS	
	MIN.	MAX.		MIN.	MAX.
a	0.230		2	5.84 TP	
A ₁	0	0		0	0
A ₂	0.165	0.185		4.19	4.70
φB	0.016	0.019	3	0.407	0.482
φB ₁	0	0		0	0
φB ₂	0.016	0.021	3	0.407	0.533
φD	0.335	0.370		8.51	9.39
φD ₁	0.305	0.335		7.75	8.50
F ₁	0.020	0.040		0.51	1.01
j	0.028	0.034		0.712	0.863
k	0.029	0.045	4	0.74	1.14
L ₁	0.000	0.050	3	0.00	1.27
L ₂	0.250	0.500	3	6.4	12.7
L ₃	0.500	0.562	3	12.7	14.27
a	30° TP			30° TP	
N	12		6	12	
N ₁	1		5	1	

NOTES:

- Refer to Rules for Dimensioning Axial Lead Product Outlines.
- Leads at gauge plane within 0.007" (0.178 mm) radius of True Position (TP) at maximum material condition.
- φB applies between L₁ and L₂. φB₂ applies between L₂ and 0.500" (12.70 mm) from seating plane. Diameter is uncontrolled in L₁ and beyond 0.500" (12.70 mm).
- Measure from Max. φD.
- N₁ is the quantity of allowable missing leads.
- N is the maximum quantity of lead positions.

Dimensional Outlines (Cont'd)

DUAL-IN-LINE SIDE-BRAZED CERAMIC PACKAGES

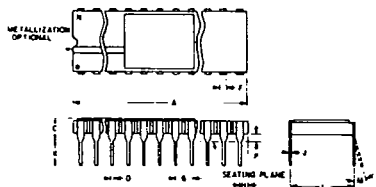

(D) SUFFIX
18-Lead Dual-In-Line
Side-Brazed Ceramic Package

SYMBOL	INCHES		NOTE	MILLIMETERS	
	MIN.	MAX.		MIN.	MAX.
A	0.890	0.915		22.606	23.241
C	—	0.200		—	5.080
D	0.015	0.021		0.381	0.533
F	0.054	REF.	1	1.371	REF.
G	0.100	BSC	1	2.54	BSC
H	0.035	0.065		0.889	1.651
J	0.008	0.012	3	0.203	0.304
K	0.125	0.150		3.175	3.810
L	0.290	0.310	2	7.366	7.874
M	0°	15°		0°	15°
P	0.025	0.045		0.635	1.143
N	18			18	

92CS-27231R1

(D) SUFFIX
22-Lead Dual-In-Line
Side-Brazed Ceramic Package

SYMBOL	INCHES		NOTE	MILLIMETERS	
	MIN.	MAX.		MIN.	MAX.
A	1.065	1.100		27.05	27.94
C	0.085	0.145		2.16	3.68
D	0.017	0.023		0.43	0.58
F	0.040	REF.	1	1.02	REF.
G	0.100	BSC	1	2.54	BSC
H	0.030	0.070		0.76	1.78
J	0.008	0.012	3	0.20	0.30
K	0.125	0.175		3.18	4.45
L	0.380	0.420	2	9.65	10.67
M	—	7°		—	7°
P	0.025	0.050		0.64	1.27
N	22			22	

92CS-25186R2

NOTES:

- Leads within 0.005" (0.13 mm) radius of True Position at maximum material condition.
- Dimension "L" to center of leads when formed parallel.
- When this device is supplied solder-dipped, the maximum lead thickness (narrow portion) will not exceed 0.013" (0.33 mm).

(D) SUFFIX
24-Lead Dual-In-Line
Side-Brazed Ceramic Package

SYMBOL	INCHES		NOTE	MILLIMETERS	
	MIN.	MAX.		MIN.	MAX.
A	1.180	1.220		29.98	30.98
C	0.085	0.145		2.16	3.68
D	0.015	0.023		0.39	0.58
F	0.040	REF.		1.02	REF.
G	0.100	BSC	1	2.54	BSC
H	0.030	0.070		0.77	1.77
J	0.008	0.012	3	0.21	0.30
K	0.125	0.175		3.18	4.44
L	0.580	0.620	2	14.74	15.74
M	—	7°		—	7°
P	0.025	0.050		0.64	1.27
N	24			24	

92CS-30968R1

(D) SUFFIX
40-Lead Dual-In-Line
Side-Brazed Ceramic Package

SYMBOL	INCHES		NOTE	MILLIMETERS	
	MIN.	MAX.		MIN.	MAX.
A	1.980	2.020		50.30	51.30
C	0.095	0.155		2.43	3.93
D	0.017	0.023		0.43	0.58
F	0.050	REF.		1.27	REF.
G	0.100	BSC	1	2.54	BSC
H	0.030	0.070		0.76	1.78
J	0.008	0.012	3	0.20	0.30
K	0.125	0.175		3.18	4.45
L	0.580	0.620	2	14.74	15.74
M	—	7°		—	7°
P	0.025	0.050		0.64	1.27
N	40			40	

92CM-27029R2

Dual-In-Line Plastic and Frit-Seal Ceramic Packages

(E) SUFFIX (JEDEC MO-001-AN)
8-Lead Dual-In-Line Plastic
(Mini-DIP) Package

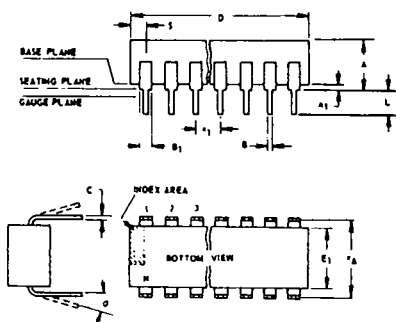

SYMBOL	INCHES		NOTE	MILLIMETERS	
	MIN.	MAX.		MIN.	MAX.
A	0.155	0.200		3.94	5.08
A ₁	0.020	0.050		0.508	1.27
B	0.014	0.020		0.356	0.508
B ₁	0.035	0.065		0.889	1.65
C	0.008	0.012	1	0.203	0.304
D	0.370	0.400		9.40	10.16
E	0.300	0.325		7.62	8.25
E ₁	0.240	0.260		6.10	6.60
e ₁	0.100	TP	2	2.54	TP
e _A	0.300	TP	2, 3	7.62	TP
L	0.125	0.150		3.18	3.81
L ₂	0.000	0.030		0.000	0.762
a	0	15	4	0	15
N	8		5	8	
N ₁	0		6	0	
O ₁	0.040	0.075		1.02	1.90
S	0.015	0.060		0.381	1.52

92CS-24026 R1

NOTES:

- Refer to Rules for Dimensioning (JEDEC Publication No. 95) for Axial Lead Product Outlines.
- When this device is supplied solder-dipped, the maximum lead thickness (narrow portion) will not exceed 0.013".
 - Leads within 0.005" (0.12 mm) radius of True Position (TP) at gauge plane with maximum material condition and unit installed.
 - e_A applies in zone L₂ when unit installed.
 - a applies to spread leads prior to installation.
 - N is the maximum quantity of lead positions.
 - N₁ is the quantity of allowable missing leads.

Dimensional Outlines (Cont'd)

Dual-In-Line Plastic and Frit-Seal Ceramic Packages (Cont'd)

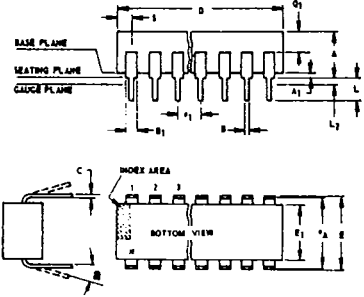

NOTES:
Refer to Rules for Dimensioning (JEDEC Publication No. 95) for Axial Lead Product Outlines.
1. When this device is supplied solder dipped, the maximum lead thickness (narrow portion) will not exceed 0.013" (0.33 mm).
2. Leads within 0.005" (0.12 mm) radius of True Position (TP) at gauge plane with maximum material condition and unit installed.
3. eA applies in zone L2 when unit installed.
4. a applies to spread leads prior to installation.
5. N is the maximum quantity of lead positions.
6. N1 is the quantity of allowable missing leads.

(E) and (F) SUFFIXES (JEDEC MO-001-AB)
14-Lead Dual-In-Line Plastic or Frit-Seal Ceramic Package

SYMBOL	INCHES		NOTE	MILLIMETERS	
	MIN.	MAX.		MIN.	MAX.
A	0.155	0.200		3.94	5.08
A ₁	0.020	0.050		0.51	1.27
B	0.014	0.020		0.356	0.508
B ₁	0.050	0.065		1.27	1.65
C	0.008	0.012	1	0.204	0.304
D	0.745	0.770		18.93	19.55
E	0.300	0.325		7.62	8.25
E ₁	0.240	0.260		6.10	6.60
e ₁	0.100 TP		2	2.54 TP	
e _A	0.300 TP		2, 3	7.62 TP	
L	0.125	0.150		3.18	3.81
L ₂	0.000	0.030		0.000	0.76
a	0°	15°	4	0°	15°
N	14		5	14	
N ₁	0		6	0	
Q ₁	0.040	0.075		1.02	1.90
S	0.065	0.090		1.66	2.28

92SS-4296R3

(E) and (F) SUFFIXES (JEDEC MO-001-AC)
16-Lead Dual-In-Line Plastic or Frit-Seal Ceramic Package

SYMBOL	INCHES		NOTE	MILLIMETERS	
	MIN.	MAX.		MIN.	MAX.
A	0.155	0.200		3.94	5.08
A ₁	0.020	0.050		0.51	1.27
B	0.014	0.020		0.356	0.508
B ₁	0.035	0.065		0.89	1.65
C	0.008	0.012	1	0.204	0.304
D	0.745	0.785		18.93	19.93
E	0.300	0.325		7.62	8.25
E ₁	0.240	0.260		6.10	6.60
e ₁	0.100 TP		2	2.54 TP	
e _A	0.300 TP		2, 3	7.62 TP	
L	0.125	0.150		3.18	3.81
L ₂	0.000	0.030		0.000	0.76
a	0°	15°	4	0°	15°
N	16		5	16	
N ₁	0		6	0	
Q ₁	0.040	0.075		1.02	1.90
S	0.015	0.060		0.39	1.52

92CM-15967R4

(E) SUFFIX
18-Lead Dual-In-Line Plastic Package

SYMBOL	INCHES		NOTE	MILLIMETERS	
	MIN.	MAX.		MIN.	MAX.
A	0.155	0.200		3.94	5.08
A ₁	0.020	0.050		0.508	1.27
B	0.014	0.020		0.356	0.508
B ₁	0.035	0.065		0.89	1.65
C	0.008	0.012	1	0.204	0.304
D	0.845	0.885		21.47	22.47
E ₁	0.240	0.260		6.10	6.60
e ₁	0.100 TP		2	2.54 TP	
e _A	0.300 TP		2, 3	7.62 TP	
L	0.125	0.150		3.18	3.81
a	0°	15°	4	0°	15°
N	18		5	18	
N ₁	0		6	0	
S	0.015	0.060		0.39	1.52

92CS-30630

(E) SUFFIX
22-Lead Dual-In-Line Plastic Package

SYMBOL	INCHES		NOTE	MILLIMETERS	
	MIN.	MAX.		MIN.	MAX.
A	0.155	0.200		3.94	5.08
A ₁	0.020	0.050		0.508	1.27
B	0.015	0.020		0.381	0.508
B ₁	0.035	0.065		0.89	1.65
C	0.008	0.012	1	0.204	0.304
D		1.120			28.44
E	0.390	0.420		9.91	10.66
E ₁	0.345	0.355		8.77	9.01
e ₁	0.100 TP		2	2.54 TP	
e _A	0.400 TP		2, 3	10.16 TP	
L	0.125	0.150		3.18	3.81
L ₂	0	0.030		0	0.762
a	2°	15°	4	2°	15°
N	22		5	22	
N ₁	0		6	0	
Q ₁	0.055	0.085		1.40	2.15
S	0.015	0.060		0.381	1.27

92CS-30830

(F) SUFFIX (JEDEC MO-001-AG)
16-Lead Dual-In-Line Frit-Seal Ceramic Package

SYMBOL	INCHES		NOTE	MILLIMETERS	
	MIN.	MAX.		MIN.	MAX.
A	0.165	0.210		4.20	5.33
A ₁	0.015	0.045		0.381	1.14
B	0.015	0.020		0.381	0.508
B ₁	0.045	0.070		1.15	1.77
C	0.009	0.011	1	0.229	0.279
D	0.750	0.795		19.05	20.19
E	0.295	0.325		7.50	8.25
E ₁	0.245	0.300		6.23	7.62
e ₁	0.100 TP		2	2.54 TP	
e _A	0.300 TP		2, 3	7.62 TP	
L	0.120	0.160		3.05	4.06
L ₂	0.000	0.030		0.000	0.76
a	2°	15°	4	2°	15°
N	16		5	16	
N ₁	0		6	0	
Q ₁	0.050	0.080		1.27	2.03
S	0.010	0.060		0.254	1.52

92CM-22284R1

(E) and (F) SUFFIXES (JEDEC MO-015-AA)
24-Lead Dual-In-Line Plastic or Frit-Seal Ceramic Package

SYMBOL	INCHES		NOTE	MILLIMETERS	
	MIN.	MAX.		MIN.	MAX.
A	0.120	0.250		3.10	6.30
A ₁	0.020	0.070		0.51	1.77
B	0.016	0.020		0.407	0.508
B ₁	0.028	0.070		0.72	1.77
C	0.008	0.012	1	0.204	0.304
D	1.20	1.29		30.48	32.76
E	0.600	0.625		15.24	15.87
E ₁	0.515	0.580		13.09	14.73
e ₁	0.100 TP		2	2.54 TP	
e _A	0.600 TP		2, 3	15.24 TP	
L	0.100	0.200		2.54	5.00
L ₂	0.000	0.030		0.00	0.76
a	0°	15°	4	0°	15°
N	24		5	24	
N ₁	0		6	0	
Q ₁	0.040	0.075		1.02	1.90
S	0.040	0.100		1.02	2.54

92CS26938R2

(E) SUFFIX
40-Lead Dual-In-Line Plastic Package

SYMBOL	INCHES		NOTE	MILLIMETERS	
	MIN.	MAX.		MIN.	MAX.
A	0.120	0.250		3.10	6.30
A ₁	0.020	0.070		0.51	1.77
B	0.016	0.020		0.407	0.508
B ₁	0.028	0.070		0.72	1.77
C	0.008	0.012	1	0.204	0.304
D	2.000	2.090		50.80	53.09
E ₁	0.515	0.580		13.09	14.73
e ₁	0.100 TP		2	2.54 TP	
e _A	0.600 TP		2, 3	15.24 TP	
L	0.100	0.200		2.54	5.00
L ₂	0.000	0.030		0.00	0.76
a	0°	15°	4	0°	15°
N	40		5	40	
N ₁	0		6	0	
Q ₁	0.065	0.095		1.66	2.41
S	0.040	0.100		1.02	2.54

92CS-30959

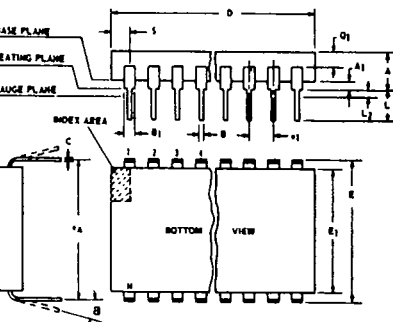

NOTES:
Refer to Rules for Dimensioning (JEDEC Publication No. 95) for Axial Lead Product Outlines.
1. When this device is supplied solder dipped, the maximum lead thickness (narrow portion) will not exceed 0.013".
2. Leads within 0.005" (0.12 mm) radius of True Position (TP) at gauge plane with maximum material condition and unit installed.
3. eA applies in zone L2 when unit installed.
4. a applies to spread leads prior to installation.
5. N is the maximum quantity of lead positions.
6. N1 is the quantity of allowable missing leads.

T-90-20

Dimensional Outlines (Cont'd)

Ceramic Flat Packs

(K) SUFFIX (JEDEC MO-004-AF)
14-Lead

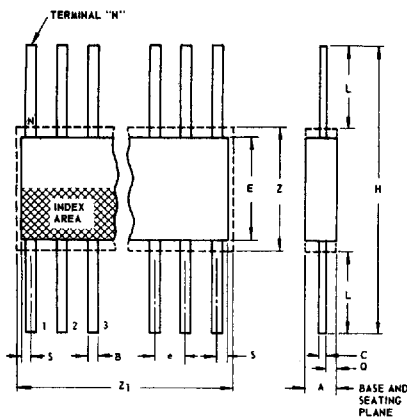

SYMBOL	INCHES		NOTE	MILLIMETERS	
	MIN.	MAX.		MIN.	MAX.
A	0.008	0.100		0.21	2.54
B	0.015	0.019	1	0.381	0.482
C	0.003	0.006	1	0.077	0.152
e	0.050 TP		2	1.27 TP	
E	0.200	0.300		5.1	7.6
H	0.600	1.000		15.3	25.4
L	0.150	0.350		3.9	8.8
N	14		3	14	
Q	0.005	0.050		0.13	1.27
S	0.000	0.050		0.00	1.27
Z	0.300		4	7.62	
Z ₁	0.400		4	10.16	

92SS-4300R3

NOTES:

1. Refer to JEDEC Publication No. 95 for Rules for Dimensioning Peripheral Lead Outlines.
2. Leads within 0.005" (0.12 mm) radius of True Position (TP) at maximum material condition.
3. N is the maximum quantity of lead positions.
4. Z and Z₁ determine a zone within which all body and lead irregularities lie.

(K) SUFFIX (JEDEC MO-004-AG)
16-Lead

SYMBOL	INCHES		NOTE	MILLIMETERS	
	MIN.	MAX.		MIN.	MAX.
A	0.008	0.100		0.21	2.54
B	0.015	0.019	1	0.381	0.482
C	0.003	0.006	1	0.077	0.152
e	0.050 TP		2	1.27 TP	
E	0.200	0.300		5.1	7.6
H	0.600	1.000		15.3	25.4
L	0.150	0.350		3.9	8.8
N	16		3	16	
Q	0.005	0.050		0.13	1.27
S	0.000	0.025		0.00	0.63
Z	0.300		4	7.62	
Z ₁	0.400		4	10.16	

92CS-17271R3

(K) SUFFIX
24-Lead

SYMBOL	INCHES		NOTE	MILLIMETERS	
	MIN.	MAX.		MIN.	MAX.
A	0.075	0.120		1.91	3.04
B	0.018	0.022	1	0.458	0.558
C	0.004	0.007	1	0.102	0.177
e	0.050 TP		2	1.27 TP	
E	0.600	0.700		15.24	17.78
H	1.150	1.350		29.21	34.29
L	0.225	0.325		5.72	8.25
N	24		3	24	
Q	0.035	0.070		0.89	1.77
S	0.060	0.110	1	1.53	2.79
Z	0.700		4	17.78	
Z ₁	0.750		4	19.05	

92CS-19949R2

(K) SUFFIX
28-Lead

SYMBOL	INCHES		NOTE	MILLIMETERS	
	MIN.	MAX.		MIN.	MAX.
A	0.075	0.120		1.91	3.04
B	0.018	0.022	1	0.458	0.558
C	0.004	0.007	1	0.102	0.177
e	0.050 TP		2	1.27 TP	
E	0.600	0.700		15.24	17.78
H	1.150	1.350		29.21	34.29
L	0.225	0.325		5.72	8.25
N	28		3	28	
Q	0.035	0.070		0.89	1.77
S	0	0.060	1	0	1.53
Z	0.700		4	17.78	
Z ₁	0.750		4	19.05	

92CS-20972