

Target Specification of 1MBI200SA-120

1. Outline Drawing (Unit : mm)

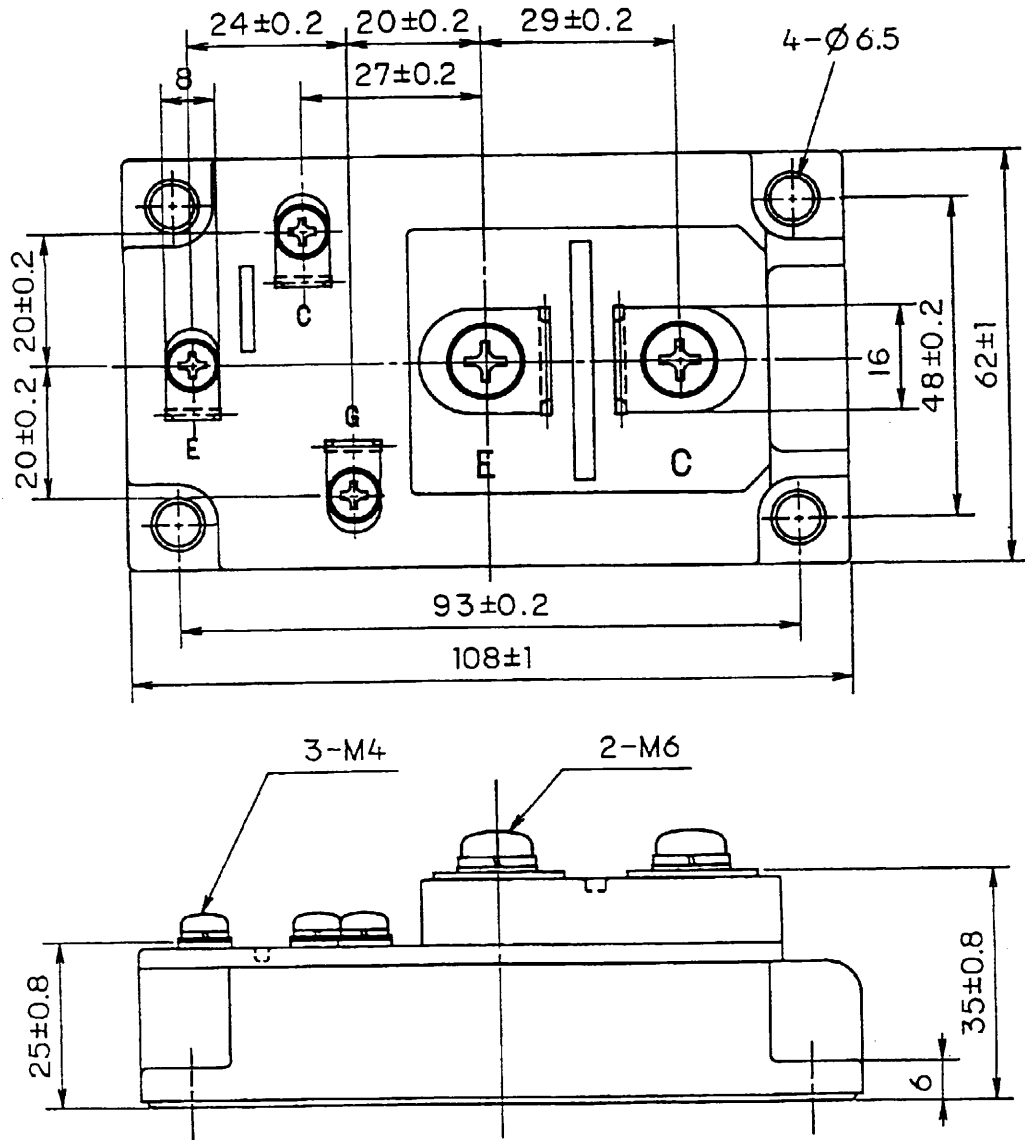

2. Equivalent circuit

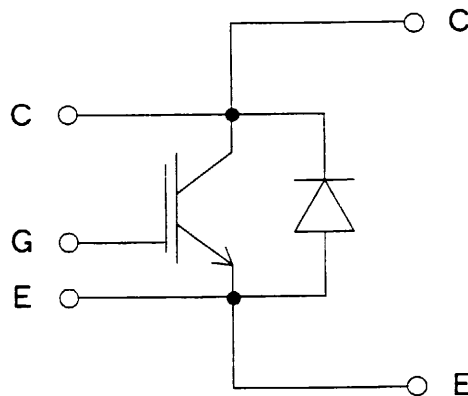

This material and the information herein is the property of Fuji Electric Co. Ltd. They shall be neither reproduced, copied, lent, or disclosed in any way whatsoever for the use of any third party nor used for the manufacturing purposes without the express written consent of Fuji Electric Co., Ltd.

REVISIONS	
-----------	--

DATE	NAME	APPROVED
DRAWN Feb -11 -99	N. Anikawa	
CHECKED Feb -11 -99	S. Miyata	T. Miyazaki

Fuji Electric Co.,Ltd.	
DWG.NO.	MT5F 9777 1/5

3. Absolute Maximum Ratings (at Tc= 25°C unless otherwise specified)

Items	Symbols	Conditions	Maximum Ratings		Units
Collector-Emitter voltage	V _{CE} S		1200		V
Gate-Emitter voltage	V _{GE} S		±20		V
Collector current	I _c	Continuous	Tc=25°C	300	A
			Tc=80°C	200	
	I _c pulse	lms	Tc=25°C	600	
			Tc=80°C	400	
	-I _c			200	
-I _c pulse		lms	400		
Collector Power Dissipation	P _c	1 device	1300		W
Junction temperature	T _j		150		°C
Storage temperature	T _{stg}		-40~ +125		°C
Isolation voltage ^(*1)	V _{iso}	AC : lmin.	2500		V
Screw Torque	Mounting ^(*2)		3.5		N · m
	Terminals ^(*3)		4.5		
	Terminals ^(*4)		1.7		

(*1) All terminals should be connected together when isolation test will be done.

(*2) Recommendable Value : 2.5~3.5 N · m (M5) or (M6)

(*3) Recommendable Value : 3.5~4.5 N · m (M6)

(*4) Recommendable Value : 1.3~1.7 N · m (M4)

4. Electrical characteristics (at Tj= 25°C unless otherwise specified)

Items	Symbols	Conditions	Characteristics			Units	
			min.	typ.	Max.		
Zero gate voltage Collector current	ICES	V _{GE} = 0 V, V _{CE} = 1200 V			4.0	mA	
Gate-Emitter leakage current	IGES	V _{CE} = 0 V, V _{GE} = ±20 V			0.8	μA	
Gate-Emitter threshold voltage	V _{GE(th)}	V _{CE} = 20 V, I _c = 200 mA	5.5	7.2	8.5	V	
Collector-Emitter saturation voltage	V _{CE(sat)}	V _{GE} = 15 V, T _j = 25 °C		2.3	2.6	V	
		I _c = 200 A, T _j = 125 °C		2.8			
Input capacitance	C _{ies}	V _{GE} = 0 V		24000		pF	
Output capacitance	C _{oes}	V _{CE} = 10 V		5000			
Reverse transfer capacitance	C _{res}	f = 1 MHz		4400			
Turn-on time	t _{on}	V _{cc} = 600 V			1.2	μs	
	t _r	I _c = 200 A			0.6		
	t _{r(i)}	V _{GE} = ±15 V		0.1			
Turn-off time	t _{off}	R _G = 4.7 Ω			1.0	μs	
	t _f			0.08	0.3		
Forward on voltage	V _F	I _F = 200 A	T _j = 25 °C		2.4	3.3	V
			T _j = 125 °C		2.0		
Reverse recovery time	t _{rr}	I _F = 200 A			0.35	μs	

5. Thermal resistance characteristics

Items	Symbols	Conditions	Characteristics			Units
			min.	typ.	Max.	
Thermal resistance (1 device)	R _{th(j-c)}	IGBT			0.096	°C/W
		FWD			0.260	
Contact Thermal resistance	R _{th(c-f)}	with Thermal Compound (*)		0.0125		

* This is the value which is defined mounting on the additional cooling fin with thermal compound.

Note :

- This specification is only for technical considerations, and not for contract.
- This specification is subject to be changed without notices.

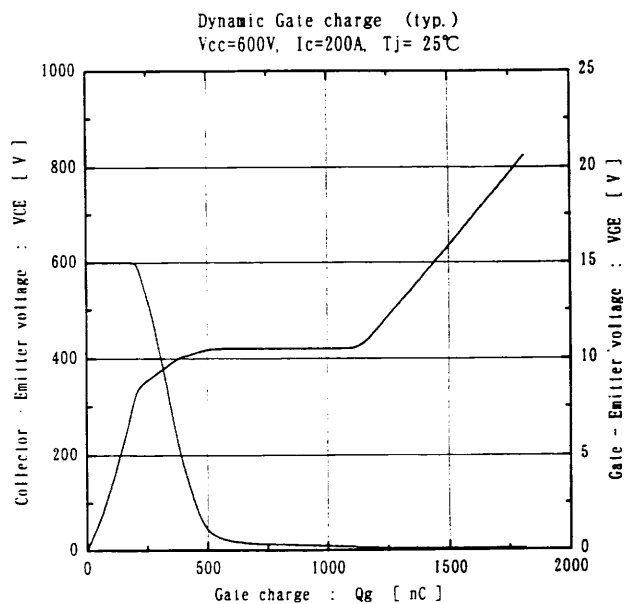
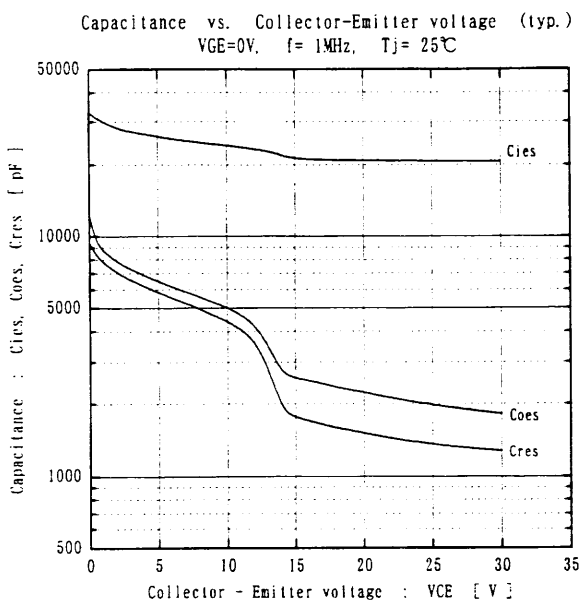
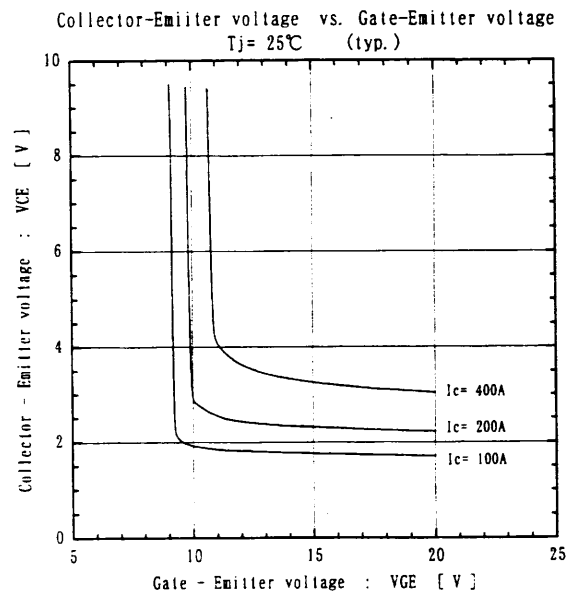
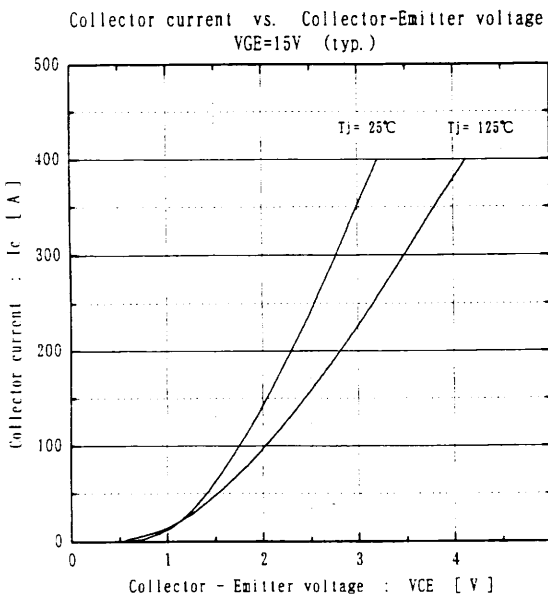
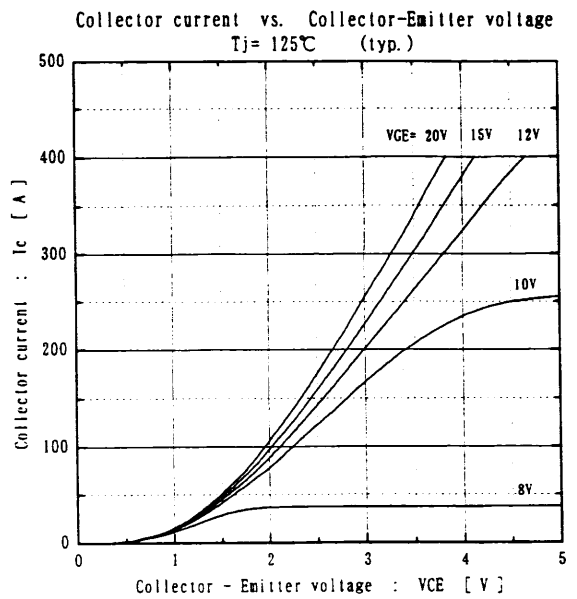
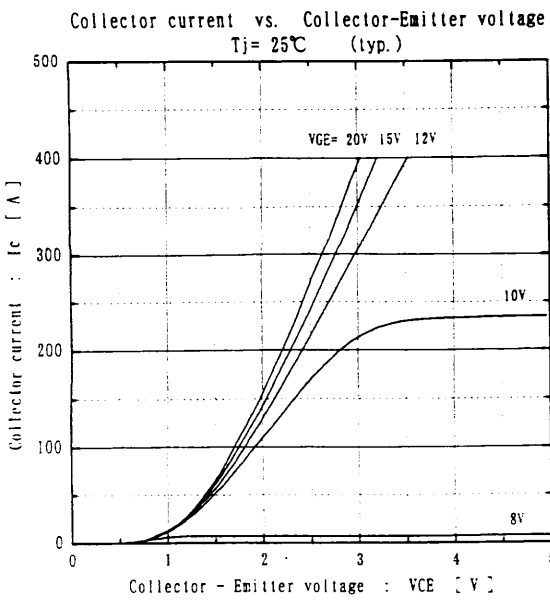

This material and the information herein is the property of Fuji Electric Co. Ltd. They shall be neither reproduced, copied, lent, or disclosed in any way whatsoever for the use of any third party, nor used for the manufacturing purposes without the express written consent of Fuji Electric Co., Ltd.

REVISIONS

Switching time vs. Collector current (typ.)
 $V_{cc}=600V, V_{GE}=\pm 15V, R_g=4.7\Omega, T_j=25^\circ C$

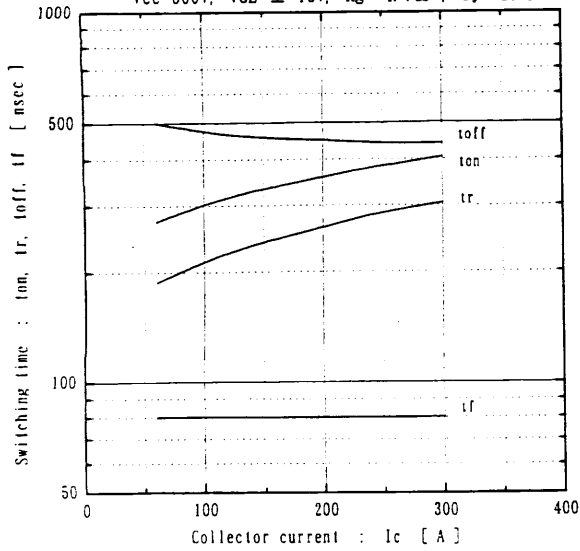

Switching time vs. Collector current (typ.)
 $V_{cc}=600V, V_{GE}=\pm 15V, R_g=4.7\Omega, T_j=125^\circ C$

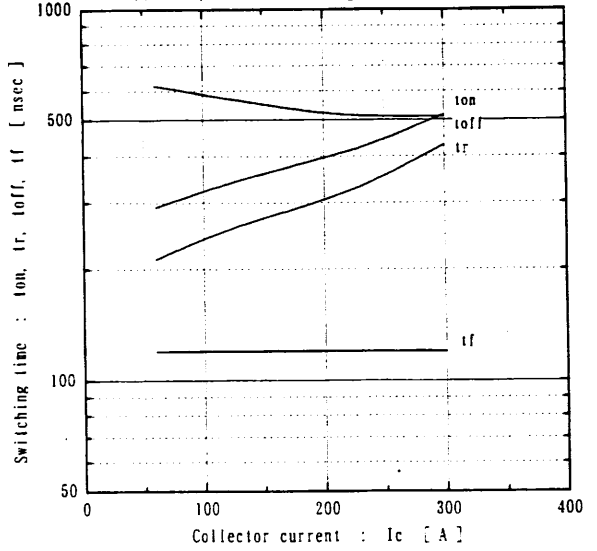

Switching time vs. Gate resistance (typ.)
 $V_{cc}=600V, I_c=200A, V_{GE}=\pm 15V, T_j=25^\circ C$

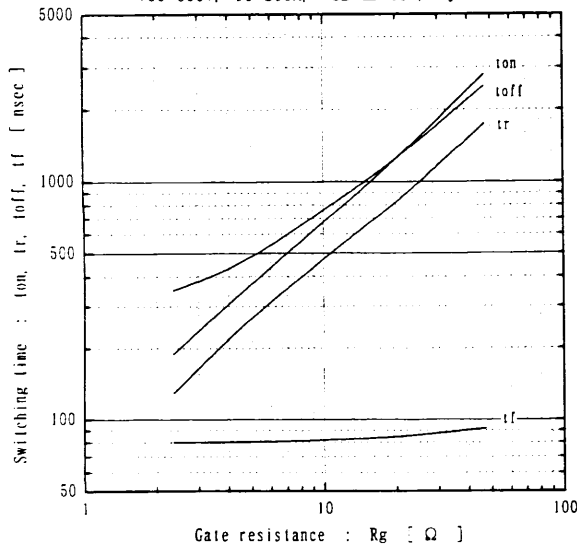

Switching loss vs. Collector current (typ.)
 $V_{cc}=600V, V_{GE}=\pm 15V, R_g=4.7\Omega$

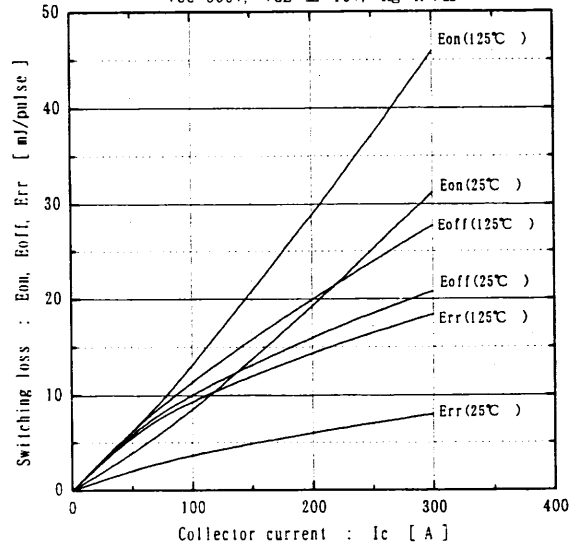

Switching loss vs. Gate resistance (typ.)
 $V_{cc}=600V, I_c=200A, V_{GE}=\pm 15V, T_j=125^\circ C$

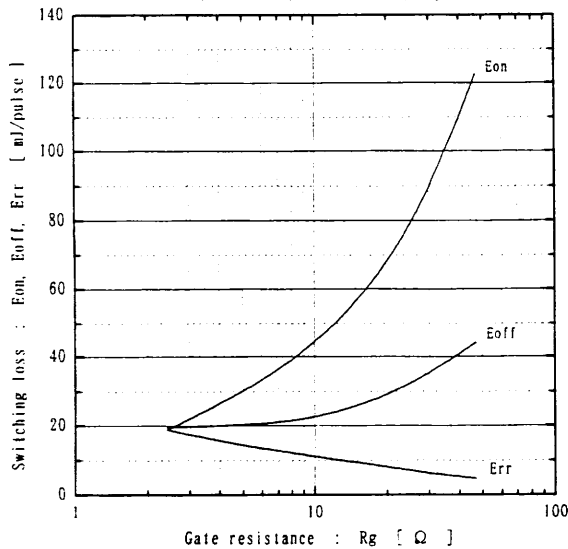

Reverse bias safe operating area
 $+V_{GE}=15V, -V_{GE}\leq 15V, R_g\geq 4.7\Omega, T_j\leq 125^\circ C$

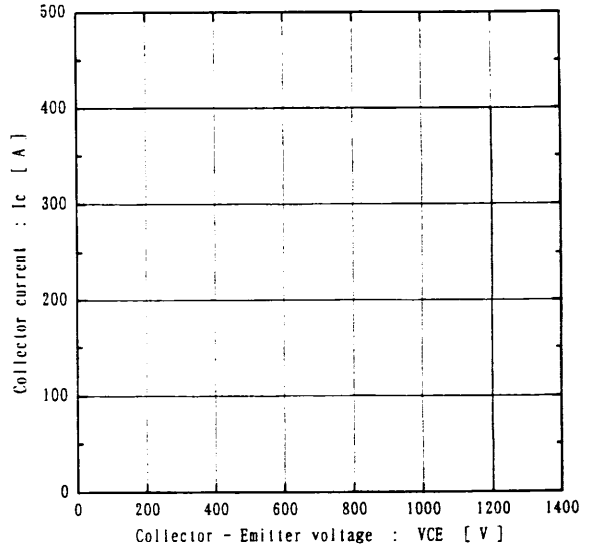

This material and the information herein is the property of Fuji Electric Co., Ltd. They shall be neither reproduced, copied, lent, or disclosed in any way whatsoever for the use of any third party nor used for the manufacturing purposes without the express written consent of Fuji Electric Co., Ltd.

Forward current vs. Forward on voltage (typ.)

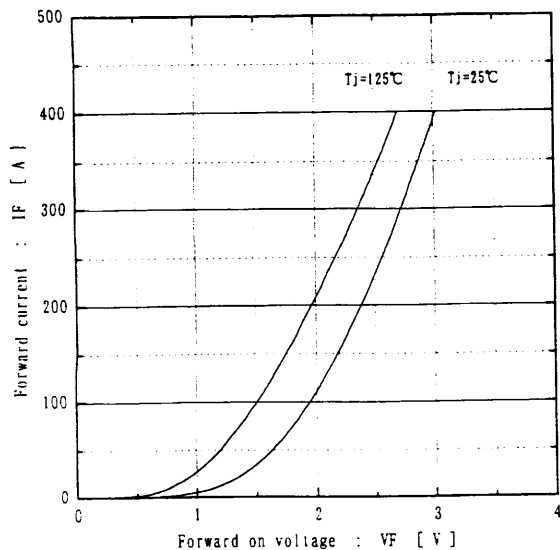

Reverse recovery characteristics (typ.)

Vcc=600V, VGE=± 15V, Rg=4.7Ω

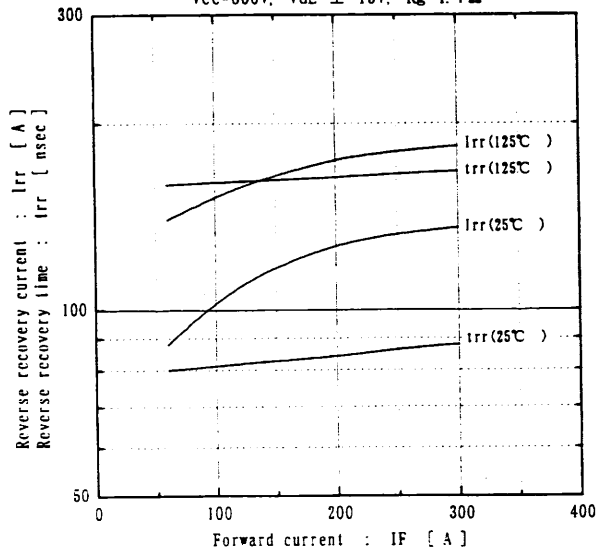

Transient thermal resistance

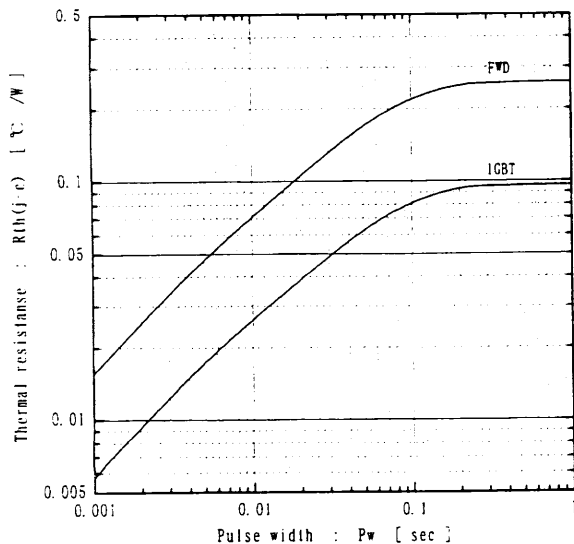

Definitions of switching time

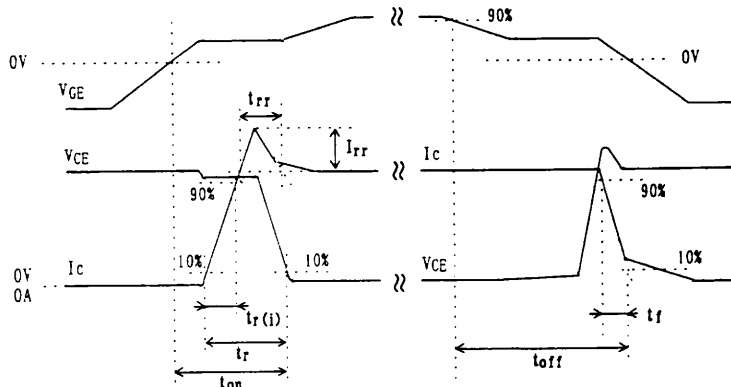
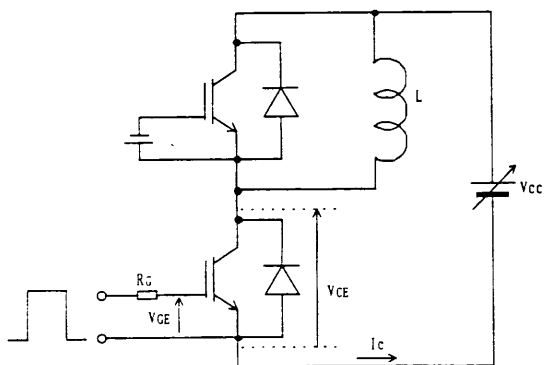

This material and the information herein is the property of Fuji Electric Co. Ltd. They shall be neither reproduced, copied, lent, or disclosed in any way whatsoever for the use of any third party nor used for the manufacturing purposes without the express written consent of Fuji Electric Co., Ltd.

REVISIONS

Fuji Electric Co., Ltd.

DWG. NO. MT5F 9777

5/5