

**Vorläufige Daten  
preliminary data**

**IGBT-Wechselrichter / IGBT-inverter**

**Höchstzulässige Werte / maximum rated values**

Kollektor-Emitter-Sperrspannung collector-emitter voltage	$T_{vj} = 25^{\circ}\text{C}$	$V_{CES}$	1200	V
Kollektor-Dauergleichstrom DC-collector current	$T_C = 80^{\circ}\text{C}$ $T_C = 25^{\circ}\text{C}$	$I_{C\ nom}$ $I_C$	15 25	A A
Periodischer Kollektor Spitzenstrom repetitive peak collector current	$t_p = 1\ \text{ms}, T_C = 80^{\circ}\text{C}$	$I_{CRM}$	30	A
Gesamt-Verlustleistung total power dissipation	$T_C = 25^{\circ}\text{C}$	$P_{tot}$	105	W
Gate-Emitter-Spitzenspannung gate-emitter peak voltage		$V_{GES}$	+/-20	V

**Charakteristische Werte / characteristic values**

			min.	typ.	max.	
Kollektor-Emitter Sättigungsspannung collector-emitter saturation voltage	$I_C = 15\ \text{A}, V_{GE} = 15\ \text{V}, T_{vj} = 25^{\circ}\text{C}$ $I_C = 15\ \text{A}, V_{GE} = 15\ \text{V}, T_{vj} = 125^{\circ}\text{C}$	$V_{CE\ sat}$		1,70 1,90	2,15	V V
Gate-Schwellenspannung gate threshold voltage	$I_C = 0,50\ \text{mA}, V_{CE} = V_{GE}, T_{vj} = 25^{\circ}\text{C}$	$V_{GEth}$	5,0	5,8	6,5	V
Gateladung gate charge	$V_{GE} = -15\ \text{V} \dots +15\ \text{V}$	$Q_G$		0,15		$\mu\text{C}$
Interner Gatewiderstand internal gate resistor	$T_{vj} = 25^{\circ}\text{C}$	$R_{Gint}$		0,0		$\Omega$
Eingangskapazität input capacitance	$f = 1\ \text{MHz}, T_{vj} = 25^{\circ}\text{C}, V_{CE} = 25\ \text{V}, V_{GE} = 0\ \text{V}$	$C_{ies}$		1,10		nF
Rückwirkungskapazität reverse transfer capacitance	$f = 1\ \text{MHz}, T_{vj} = 25^{\circ}\text{C}, V_{CE} = 25\ \text{V}, V_{GE} = 0\ \text{V}$	$C_{res}$		0,04		nF
Kollektor-Emitter Reststrom collector-emitter cut-off current	$V_{CE} = 1200\ \text{V}, V_{GE} = 0\ \text{V}, T_{vj} = 25^{\circ}\text{C}$	$I_{CES}$			5,0	mA
Gate-Emitter Reststrom gate-emitter leakage current	$V_{CE} = 0\ \text{V}, V_{GE} = 20\ \text{V}, T_{vj} = 25^{\circ}\text{C}$	$I_{GES}$			400	nA
Einschaltverzögerungszeit (ind. Last) turn-on delay time (inductive load)	$I_C = 15\ \text{A}, V_{CE} = 600\ \text{V}$ $V_{GE} = \pm 15\ \text{V}, R_{Gon} = 75\ \Omega, T_{vj} = 25^{\circ}\text{C}$ $V_{GE} = \pm 15\ \text{V}, R_{Gon} = 75\ \Omega, T_{vj} = 125^{\circ}\text{C}$	$t_{d\ on}$		0,09 0,09		$\mu\text{s}$ $\mu\text{s}$
Anstiegszeit (induktive Last) rise time (inductive load)	$I_C = 15\ \text{A}, V_{CE} = 600\ \text{V}$ $V_{GE} = \pm 15\ \text{V}, R_{Gon} = 75\ \Omega, T_{vj} = 25^{\circ}\text{C}$ $V_{GE} = \pm 15\ \text{V}, R_{Gon} = 75\ \Omega, T_{vj} = 125^{\circ}\text{C}$	$t_r$		0,03 0,05		$\mu\text{s}$ $\mu\text{s}$
Abschaltverzögerungszeit (ind. Last) turn-off delay time (inductive load)	$I_C = 15\ \text{A}, V_{CE} = 600\ \text{V}$ $V_{GE} = \pm 15\ \text{V}, R_{Goff} = 75\ \Omega, T_{vj} = 25^{\circ}\text{C}$ $V_{GE} = \pm 15\ \text{V}, R_{Goff} = 75\ \Omega, T_{vj} = 125^{\circ}\text{C}$	$t_{d\ off}$		0,42 0,52		$\mu\text{s}$ $\mu\text{s}$
Fallzeit (induktive Last) fall time (inductive load)	$I_C = 15\ \text{A}, V_{CE} = 600\ \text{V}$ $V_{GE} = \pm 15\ \text{V}, R_{Goff} = 75\ \Omega, T_{vj} = 25^{\circ}\text{C}$ $V_{GE} = \pm 15\ \text{V}, R_{Goff} = 75\ \Omega, T_{vj} = 125^{\circ}\text{C}$	$t_f$		0,07 0,09		$\mu\text{s}$ $\mu\text{s}$
Einschaltverlustenergie pro Puls turn-on energy loss per pulse	$I_C = 15\ \text{A}, V_{CE} = 600\ \text{V}, L_s = 45\ \text{nH}$ $V_{GE} = \pm 15\ \text{V}, R_{Gon} = 75\ \Omega, T_{vj} = 25^{\circ}\text{C}$ $V_{GE} = \pm 15\ \text{V}, R_{Gon} = 75\ \Omega, T_{vj} = 125^{\circ}\text{C}$	$E_{on}$		1,50 2,10		mJ mJ
Abschaltverlustenergie pro Puls turn-off energy loss per pulse	$I_C = 15\ \text{A}, V_{CE} = 600\ \text{V}, L_s = 45\ \text{nH}$ $V_{GE} = \pm 15\ \text{V}, R_{Goff} = 75\ \Omega, T_{vj} = 25^{\circ}\text{C}$ $V_{GE} = \pm 15\ \text{V}, R_{Goff} = 75\ \Omega, T_{vj} = 125^{\circ}\text{C}$	$E_{off}$		1,10 1,30		mJ mJ
Kurzschlußverhalten SC data	$t_p \leq 10\ \mu\text{s}, V_{GE} \leq 15\ \text{V}$ $T_{vj} \leq 125^{\circ}\text{C}, V_{CC} = 900\ \text{V}, V_{CEmax} = V_{CES} - L_{sCE} \cdot di/dt$	$I_{SC}$		60		A
Innerer Wärmewiderstand thermal resistance, junction to case	pro IGBT per IGBT	$R_{thJC}$			1,20	K/W

prepared by: Andreas Schulz	date of publication: 2003-12-2
approved by: Robert Severin	revision: 2.1

**Vorläufige Daten  
preliminary data**

**Diode-Wechselrichter / diode-inverter**

**Höchstzulässige Werte / maximum rated values**

Periodische Spitzensperrspannung repetitive peak reverse voltage	$T_{vj} = 25^{\circ}\text{C}$	$V_{RRM}$	1200	V
Dauergleichstrom DC forward current		$I_F$	15	A
Periodischer Spitzenstrom repetitive peak forward current	$t_p = 1\text{ ms}$	$I_{FRM}$	30	A
Grenzlastintegral $I^2t$ - value	$V_R = 0\text{ V}, t_p = 10\text{ ms}, T_{vj} = 125^{\circ}\text{C}$	$I^2t$	60,0	A <sup>2</sup> s

**Charakteristische Werte / characteristic values**

			min.	typ.	max.	
Durchlassspannung forward voltage	$I_F = 15\text{ A}, V_{GE} = 0\text{ V}, T_{vj} = 25^{\circ}\text{C}$ $I_F = 15\text{ A}, V_{GE} = 0\text{ V}, T_{vj} = 125^{\circ}\text{C}$	$V_F$		1,65 1,65	2,15	V V
Rückstromspitze peak reverse recovery current	$I_F = 15\text{ A}, -di_F/dt = 400\text{ A}/\mu\text{s}$ $V_R = 600\text{ V}, V_{GE} = -15\text{ V}, T_{vj} = 25^{\circ}\text{C}$ $V_R = 600\text{ V}, V_{GE} = -15\text{ V}, T_{vj} = 125^{\circ}\text{C}$	$I_{RM}$		16,0 15,0		A A
Sperrverzögerungsladung recovered charge	$I_F = 15\text{ A}, -di_F/dt = 400\text{ A}/\mu\text{s}$ $V_R = 600\text{ V}, V_{GE} = -15\text{ V}, T_{vj} = 25^{\circ}\text{C}$ $V_R = 600\text{ V}, V_{GE} = -15\text{ V}, T_{vj} = 125^{\circ}\text{C}$	$Q_r$		1,80 3,00		$\mu\text{C}$ $\mu\text{C}$
Abschaltenergie pro Puls reverse recovery energy	$I_F = 15\text{ A}, -di_F/dt = 400\text{ A}/\mu\text{s}$ $V_R = 600\text{ V}, V_{GE} = -15\text{ V}, T_{vj} = 25^{\circ}\text{C}$ $V_R = 600\text{ V}, V_{GE} = -15\text{ V}, T_{vj} = 125^{\circ}\text{C}$	$E_{rec}$		0,55 1,10		mJ mJ
Innerer Wärmewiderstand thermal resistance, junction to case	pro Diode per diode	$R_{thJC}$			1,50	K/W

**Diode-Gleichrichter / diode-rectifier**

**Höchstzulässige Werte / maximum rated values**

Periodische Rückw. Spitzensperrspannung repetitive peak reverse voltage	$T_{vj} = 25^{\circ}\text{C}$	$V_{RRM}$	1600	V
Durchlassstrom Grenzeffektivwert pro Dio. forward current RMS maximum per diode	$T_C = 80^{\circ}\text{C}$	$I_{FRMSM}$	50	A
Gleichrichter Ausgang Grenzeffektivstrom maximum RMS current at Rectifier output	$T_C = 80^{\circ}\text{C}$	$I_{RMSM}$	60	A
Stoßstrom Grenzwert surge forward current	$t_p = 10\text{ ms}, T_{vj} = 25^{\circ}\text{C}$ $t_p = 10\text{ ms}, T_{vj} = 150^{\circ}\text{C}$	$I_{FSM}$	315 260	A A
Grenzlastintegral $I^2t$ - value	$t_p = 10\text{ ms}, T_{vj} = 25^{\circ}\text{C}$ $t_p = 10\text{ ms}, T_{vj} = 150^{\circ}\text{C}$	$I^2t$	495 340	A <sup>2</sup> s A <sup>2</sup> s

**Charakteristische Werte / characteristic values**

			min.	typ.	max.	
Durchlassspannung forward voltage	$T_{vj} = 150^{\circ}\text{C}, I_F = 15\text{ A}$	$V_F$		0,90		V
Sperrstrom reverse current	$T_{vj} = 150^{\circ}\text{C}, V_R = 1600\text{ V}$	$I_R$		2,00		mA
Innerer Wärmewiderstand thermal resistance, junction to case	pro Diode per diode	$R_{thJC}$			1,00	K/W

prepared by: Andreas Schulz	date of publication: 2003-12-2
approved by: Robert Severin	revision: 2.1

**Vorläufige Daten  
preliminary data**

**IGBT-Brems-Chopper / IGBT-brake-chopper  
Höchstzulässige Werte / maximum rated values**

Kollektor-Emitter-Sperrspannung collector-emitter voltage	$T_{vj} = 80^{\circ}\text{C}$	$V_{CES}$	1200	V
Kollektor-Dauergleichstrom DC-collector current	$T_c = 80^{\circ}\text{C}$ $T_c = 25^{\circ}\text{C}$	$I_{Cnom}$ $I_C$	10 18	A A
Periodischer Kollektor Spitzenstrom repetitive peak collector current	$t_p = 1 \text{ ms}, T_c = 80^{\circ}\text{C}$	$I_{CRM}$	20	A
Gesamt-Verlustleistung total power dissipation	$T_c = 25^{\circ}\text{C}$	$P_{tot}$	83,5	W
Gate-Emitter-Spitzenspannung gate-emitter peak voltage		$V_{GES}$	+/-20	V

**Charakteristische Werte / characteristic values**

			min.	typ.	max.	
Kollektor-Emitter Sättigungsspannung collector-emitter saturation voltage	$I_C = 10 \text{ A}, V_{GE} = 15 \text{ V}, T_{vj} = 25^{\circ}\text{C}$ $I_C = 10 \text{ A}, V_{GE} = 15 \text{ V}, T_{vj} = 125^{\circ}\text{C}$	$V_{CE sat}$		1,85 2,15	2,45	V V
Gate-Schwellenspannung gate threshold voltage	$I_C = 0,30 \text{ mA}, V_{CE} = V_{GE}, T_{vj} = 25^{\circ}\text{C}$	$V_{GEth}$	5,0	5,8	6,5	V
Gateladung gate charge	$V_{GE} = -15 \text{ V} \dots +15 \text{ V}$	$Q_G$		0,10		$\mu\text{C}$
Interner Gatewiderstand internal gate resistor		$R_{Gint}$		0,00		$\Omega$
Eingangskapazität input capacitance	$f = 1 \text{ MHz}, T_{vj} = 25^{\circ}\text{C}$ $V_{CE} = 25 \text{ V}, V_{GE} = 0 \text{ V}$	$C_{ies}$		0,60		nF
Rückwirkungskapazität reverse transfer capacitance	$f = 1 \text{ MHz}, T_{vj} = 25^{\circ}\text{C}$ $V_{CE} = 25 \text{ V}, V_{GE} = 0 \text{ V}$	$C_{res}$		0,026		nF
Kollektor-Emitter Reststrom collector-emitter cut-off current	$V_{CE} = 1200 \text{ V}, V_{GE} = 0 \text{ V}, T_{vj} = 25^{\circ}\text{C}$	$I_{CES}$			5,0	mA
Gate-Emitter Reststrom gate-emitter leakage current	$V_{CE} = 0 \text{ V}, V_{GE} = 20 \text{ V}, T_{vj} = 25^{\circ}\text{C}$	$I_{GES}$			400	nA
Einschaltverzögerungszeit (ind. Last) turn-on delay time (inductive load)	$I_C = 10 \text{ A}, V_{CE} = 600 \text{ V}$ $V_{GE} = \pm 15 \text{ V}, R_{Gon} = 100 \Omega, T_{vj} = 25^{\circ}\text{C}$ $V_{GE} = \pm 15 \text{ V}, R_{Gon} = 100 \Omega, T_{vj} = 125^{\circ}\text{C}$	$t_{d on}$		0,09 0,09		$\mu\text{s}$ $\mu\text{s}$
Anstiegszeit (induktive Last) rise time (inductive load)	$I_C = 10 \text{ A}, V_{CE} = 600 \text{ V}$ $V_{GE} = \pm 15 \text{ V}, R_{Gon} = 100 \Omega, T_{vj} = 25^{\circ}\text{C}$ $V_{GE} = \pm 15 \text{ V}, R_{Gon} = 100 \Omega, T_{vj} = 125^{\circ}\text{C}$	$t_r$		0,03 0,05		$\mu\text{s}$ $\mu\text{s}$
Abschaltverzögerungszeit (ind. Last) turn-off delay time (inductive load)	$I_C = 10 \text{ A}, V_{CE} = 600 \text{ V}$ $V_{GE} = \pm 15 \text{ V}, R_{Goff} = 100 \Omega, T_{vj} = 25^{\circ}\text{C}$ $V_{GE} = \pm 15 \text{ V}, R_{Goff} = 100 \Omega, T_{vj} = 125^{\circ}\text{C}$	$t_{d off}$		0,42 0,52		$\mu\text{s}$ $\mu\text{s}$
Fallzeit (induktive Last) fall time (inductive load)	$I_C = 10 \text{ A}, V_{CE} = 600 \text{ V}$ $V_{GE} = \pm 15 \text{ V}, R_{Goff} = 100 \Omega, T_{vj} = 25^{\circ}\text{C}$ $V_{GE} = \pm 15 \text{ V}, R_{Goff} = 100 \Omega, T_{vj} = 125^{\circ}\text{C}$	$t_f$		0,07 0,09		$\mu\text{s}$ $\mu\text{s}$
Einschaltverlustenergie pro Puls turn-on energy loss per pulse	$I_C = 10 \text{ A}, V_{CE} = 600 \text{ V}$ $V_{GE} = \pm 15 \text{ V}, R_{Gon} = 100 \Omega, T_{vj} = 25^{\circ}\text{C}$ $V_{GE} = \pm 15 \text{ V}, R_{Gon} = 100 \Omega, T_{vj} = 125^{\circ}\text{C}$	$E_{on}$		1,00 1,40		mJ mJ
Abschaltverlustenergie pro Puls turn-off energy loss per pulse	$I_C = 10 \text{ A}, V_{CE} = 600 \text{ V}$ $V_{GE} = \pm 15 \text{ V}, R_{Goff} = 100 \Omega, T_{vj} = 25^{\circ}\text{C}$ $V_{GE} = \pm 15 \text{ V}, R_{Goff} = 100 \Omega, T_{vj} = 125^{\circ}\text{C}$	$E_{off}$		0,90 1,00		mJ mJ
Kurzschlußverhalten SC data	$t_p \leq 10 \mu\text{sec}, V_{GE} \leq 15 \text{ V}$ $T_{vj} \leq 125^{\circ}\text{C}, V_{CC} = 900 \text{ V}, V_{CEmax} = V_{CES} - L_{sCE} \cdot di/dt$	$I_{SC}$		40		A
Innerer Wärmewiderstand thermal resistance, junction to case	pro IGBT per IGBT	$R_{thJC}$			1,50	K/W

prepared by: Andreas Schulz	date of publication: 2003-12-2
approved by: Robert Severin	revision: 2.1

**Vorläufige Daten  
preliminary data**

**Diode-Brems-Chopper / Diode-brake-chopper  
Höchstzulässige Werte / maximum rated values**

Periodische Spitzensperrspannung repetitive peak reverse voltage	$T_{vj} = 80^{\circ}\text{C}$	$V_{RRM}$	1200	V
Dauergleichstrom DC forward current		$I_F$	10	A
Periodischer Spitzenstrom repetitive peak forw. current	$t_p = 1 \text{ ms}$	$I_{FRM}$	20	A
Grenzlastintegral $I^2t$ - value	$V_R = 0 \text{ V}, t_p = 10 \text{ ms}, T_{vj} = 125^{\circ}\text{C}$	$I^2t$	20,0	A <sup>2</sup> s

**Charakteristische Werte / characteristic values**

			min.	typ.	max.	
Durchlaßspannung forward voltage	$I_F = 10 \text{ A}, V_{GE} = 0 \text{ V}, T_{vj} = 25^{\circ}\text{C}$ $I_F = 10 \text{ A}, V_{GE} = 0 \text{ V}, T_{vj} = 125^{\circ}\text{C}$	$V_F$		1,80 1,85	2,25	V V
Rückstromspitze peak reverse recovery current	$I_F = 10 \text{ A}, -di_F/dt = 400 \text{ A}/\mu\text{s}$ $V_R = 600 \text{ V}, V_{GE} = -15 \text{ V}, T_{vj} = 25^{\circ}\text{C}$ $V_R = 600 \text{ V}, V_{GE} = -15 \text{ V}, T_{vj} = 125^{\circ}\text{C}$	$I_{RM}$		14,0 15,0		A A
Sperrverzögerungsladung recovered charge	$I_F = 10 \text{ A}, -di_F/dt = 400 \text{ A}/\mu\text{s}$ $V_R = 600 \text{ V}, V_{GE} = -15 \text{ V}, T_{vj} = 25^{\circ}\text{C}$ $V_R = 600 \text{ V}, V_{GE} = -15 \text{ V}, T_{vj} = 125^{\circ}\text{C}$	$Q_r$		1,00 1,80		$\mu\text{C}$ $\mu\text{C}$
Abschaltenergie pro Puls reverse recovery energy	$I_F = 10 \text{ A}, -di_F/dt = 400 \text{ A}/\mu\text{s}$ $V_R = 600 \text{ V}, V_{GE} = -15 \text{ V}, T_{vj} = 25^{\circ}\text{C}$ $V_R = 600 \text{ V}, V_{GE} = -15 \text{ V}, T_{vj} = 125^{\circ}\text{C}$	$E_{rec}$		0,26 0,56		mJ mJ
Innerer Wärmewiderstand thermal resistance, junction to case	pro Diode per diode	$R_{thJC}$			2,30	K/W

**NTC-Widerstand / NTC-thermistor**

**Charakteristische Werte / characteristic values**

			min.	typ.	max.	
Nennwiderstand rated resistance	$T_C = 25^{\circ}\text{C}$	$R_{25}$		5,00		k $\Omega$
Abweichung von $R_{100}$ deviation of $R_{100}$	$T_C = 100^{\circ}\text{C}, R_{100} = 493 \Omega$	$\Delta R/R$	-5		5	%
Verlustleistung power dissipation	$T_C = 25^{\circ}\text{C}$	$P_{25}$			20,0	mW
B-Wert B-value	$R_2 = R_{25} \exp [B_{25}/50(1/T_2 - 1/(298,15 \text{ K}))]$	$B_{25}/50$		3375		K

prepared by: Andreas Schulz	date of publication: 2003-12-2
approved by: Robert Severin	revision: 2.1

# Technische Information / technical information

IGBT-Module  
IGBT-modules

## FP15R12KT3

power electronics in motion  
**eupec**

### Vorläufige Daten preliminary data

#### Modul / module

Isolations-Prüfspannung insulation test voltage	RMS, f = 50 Hz, t = 1 min	V <sub>ISO</sub>	2,5		kV
Material Modulgrundplatte material of module baseplate			Cu		
Material für innere Isolation material for internal insulation			Al <sub>2</sub> O <sub>3</sub>		
Kriechstrecke creepage distance	Kontakt - Kühlkörper / terminal to heatsink Kontakt - Kontakt / terminal to terminal		10,0		mm
Luftstrecke clearance distance	Kontakt - Kühlkörper / terminal to heatsink Kontakt - Kontakt / terminal to terminal		7,50		mm
Vergleichszahl der Kriechwegbildung comparative tracking index		CTI	> 225		
			min.	typ.	max.
Übergangs-Wärmewiderstand thermal resistance, case to heatsink	pro Modul / per module $\lambda_{\text{Paste}} = 1 \text{ W}/(\text{m}\cdot\text{K}) / \lambda_{\text{grease}} = 1 \text{ W}/(\text{m}\cdot\text{K})$	R <sub>thCH</sub>		0,02	K/W
Modulinduktivität stray inductance module		L <sub>sCE</sub>		60	nH
Modulleitungswiderstand, Anschlüsse - Chip module lead resistance, terminals - chip	T <sub>C</sub> = 25°C, pro Schalter / per switch	R <sub>CC'+EE'</sub> R <sub>AA'+CC'</sub>		4,00 3,00	mΩ
Höchstzulässige Sperrschichttemperatur maximum junction temperature		T <sub>vj max</sub>			150 °C
Temperatur im Schaltbetrieb temperature under switching conditions		T <sub>vj op</sub>	-40		125 °C
Lagertemperatur storage temperature		T <sub>stg</sub>	-40		125 °C
Anzugsdrehmoment f. mech. Befestigung mounting torque	Schraube / screw M5	M	3,00	-	6,00 Nm
Gewicht weight		G		180	g

**Mit dieser technischen Information werden Halbleiterbauelemente spezifiziert, jedoch keine Eigenschaften zugesichert. Sie gilt in Verbindung mit den zugehörigen technischen Erläuterungen.**

**This technical information specifies semiconductor devices but guarantees no characteristics. It is valid with the appropriate technical explanations.**

prepared by: Andreas Schulz	date of publication: 2003-12-2
approved by: Robert Severin	revision: 2.1

**Vorläufige Daten**  
preliminary data

**Ausgangskennlinie IGBT-Wechselr. (typisch)**  
output characteristic IGBT-inverter (typical)  
 $I_c = f(V_{CE})$   
 $V_{GE} = 15\text{ V}$

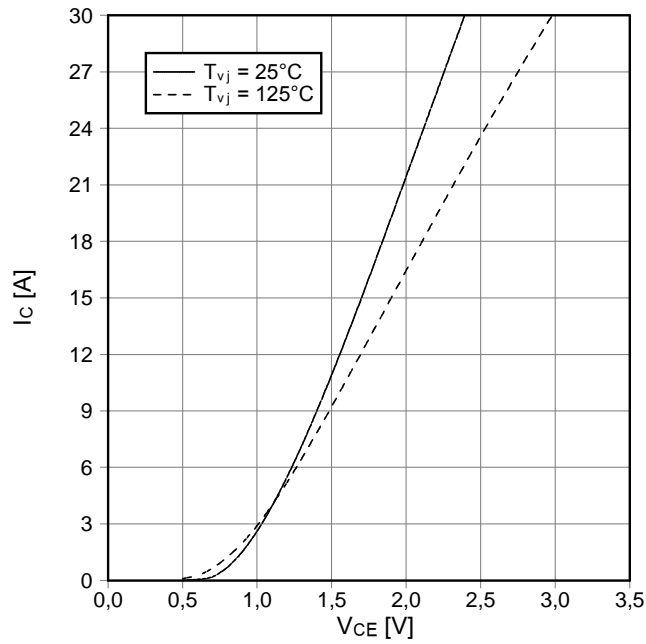

**Ausgangskennlinienfeld IGBT-Wechselr. (typisch)**  
output characteristic IGBT-inverter (typical)  
 $I_c = f(V_{CE})$   
 $T_{vj} = 125^\circ\text{C}$

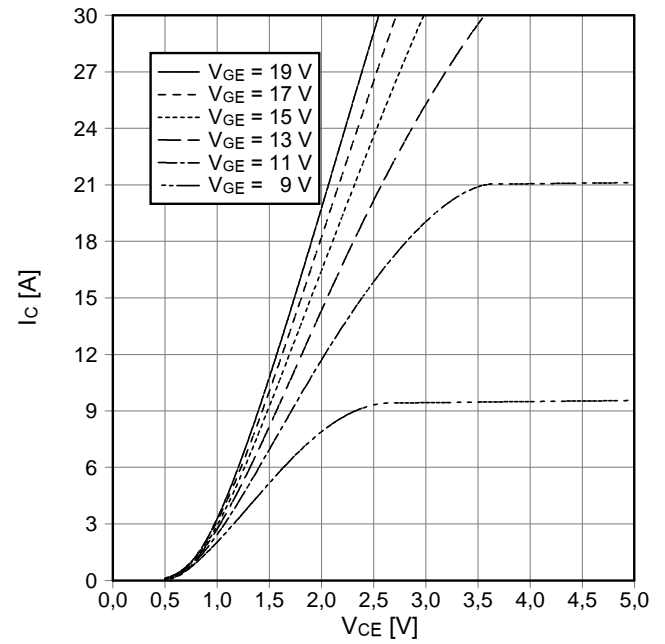

**Übertragungscharakteristik IGBT-Wechselr. (typisch)**  
transfer characteristic IGBT-inverter (typical)  
 $I_c = f(V_{GE})$   
 $V_{CE} = 20\text{ V}$

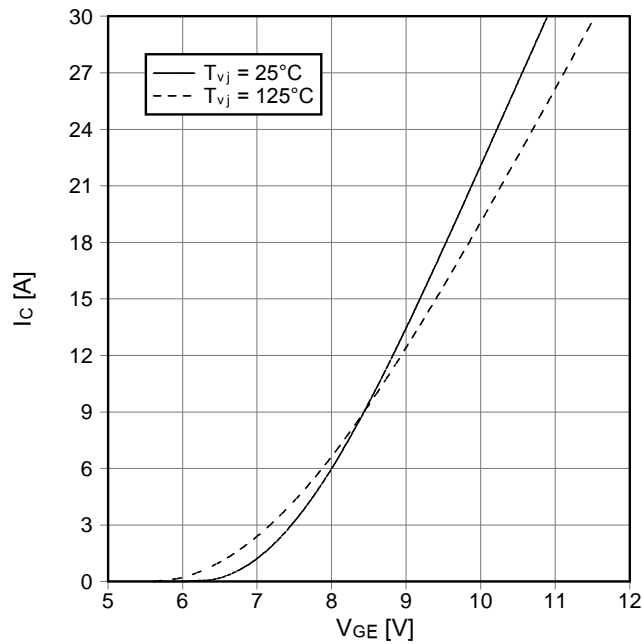

**Schaltverluste IGBT-Wechselr. (typisch)**  
switching losses IGBT-inverter (typical)  
 $E_{on} = f(I_c)$ ,  $E_{off} = f(I_c)$   
 $V_{GE} = \pm 15\text{ V}$ ,  $R_{Gon} = 75\ \Omega$ ,  $R_{Goff} = 75\ \Omega$ ,  $V_{CE} = 600\text{ V}$ ,  
 $T_{vj} = 125^\circ\text{C}$

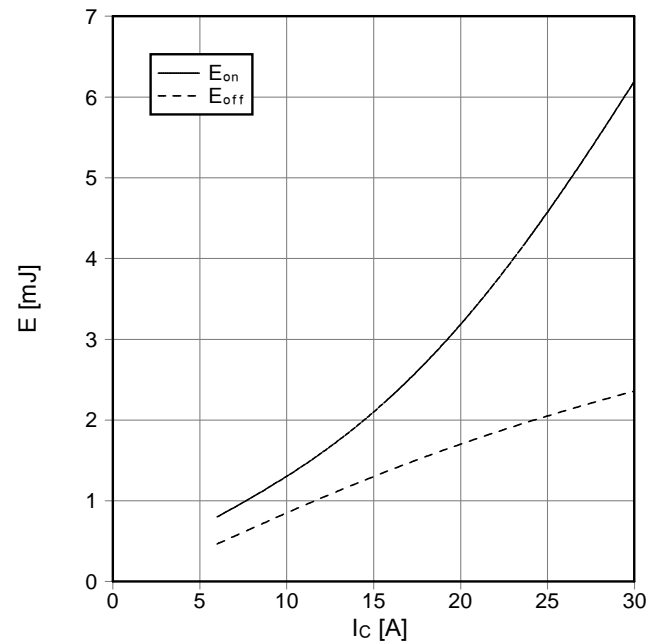

prepared by: Andreas Schulz	date of publication: 2003-12-2
approved by: Robert Severin	revision: 2.1

**Vorläufige Daten**  
**preliminary data**

**Schaltverluste IGBT-Wechselr. (typisch)**  
**switching losses IGBT-inverter (typical)**  
 $E_{on} = f(R_G), E_{off} = f(R_G)$   
 $V_{GE} = \pm 15\text{ V}, I_C = 15\text{ A}, V_{CE} = 600\text{ V}, T_{vj} = 125^\circ\text{C}$

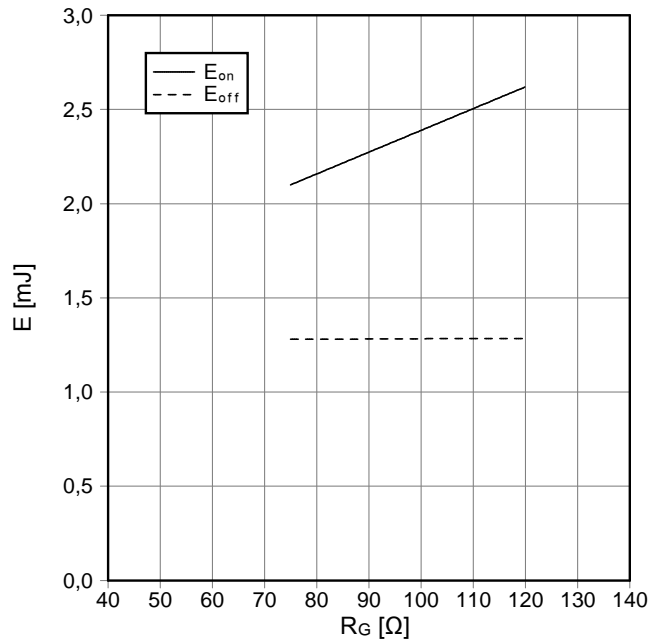

**Transienter Wärmewiderstand IGBT-Wechselr.**  
**transient thermal impedance IGBT-inverter**  
 $Z_{thJC} = f(t)$

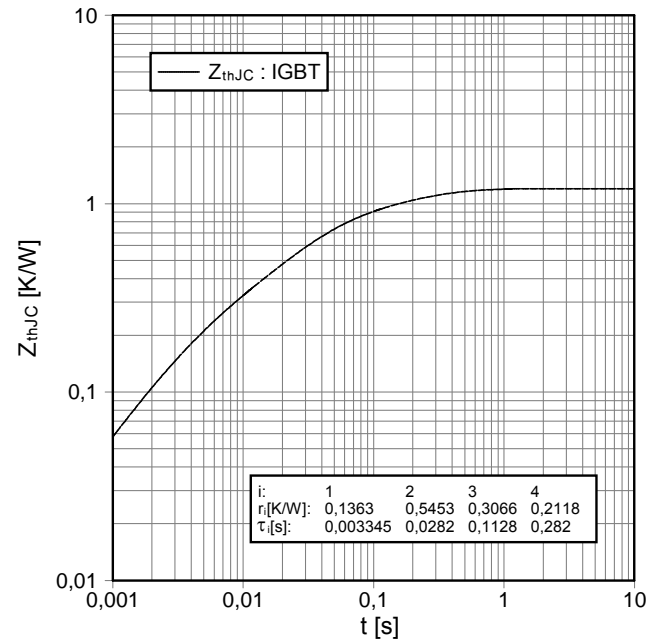

**Sicherer Rückwärts-Arbeitsbereich IGBT-Wr. (RBSOA)**  
**reverse bias safe operating area IGBT-inv. (RBSOA)**  
 $I_C = f(V_{CE})$   
 $V_{GE} = \pm 15\text{ V}, R_{Goff} = 75\ \Omega, T_{vj} = 125^\circ\text{C}$

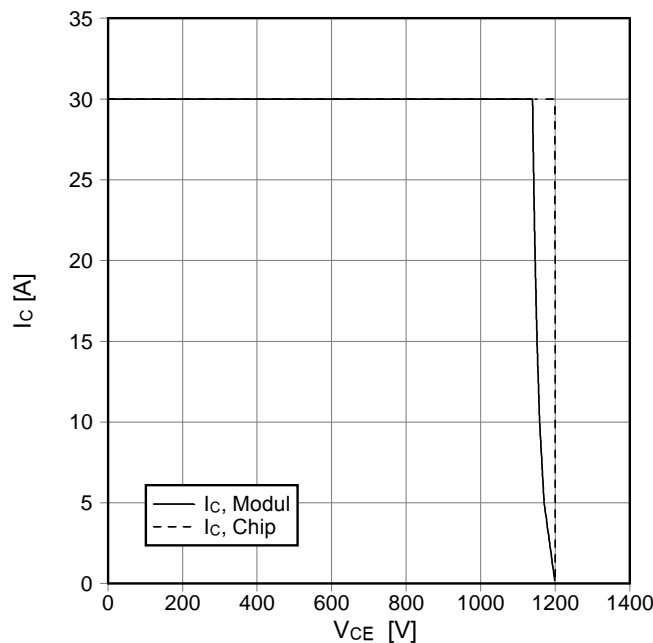

**Durchlaßkennlinie der Diode-Wechselr. (typisch)**  
**forward characteristic of diode-inverter (typical)**  
 $I_F = f(V_F)$

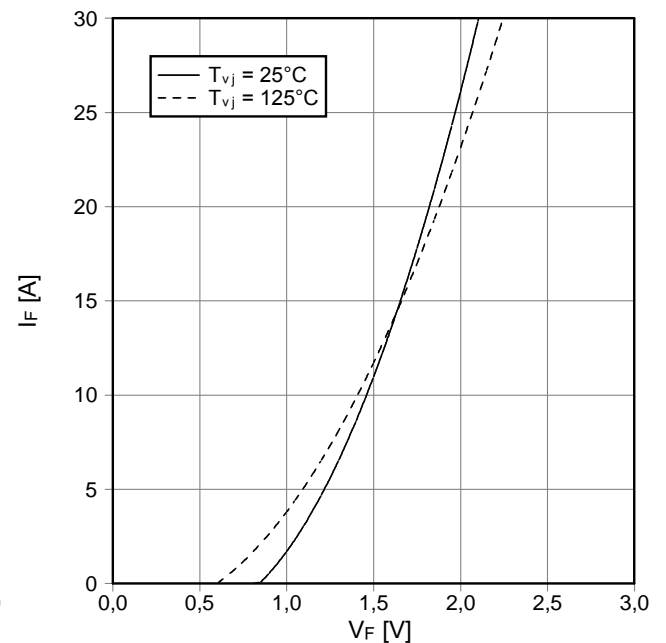

prepared by: Andreas Schulz	date of publication: 2003-12-2
approved by: Robert Severin	revision: 2.1

**Vorläufige Daten**  
**preliminary data**

Schaltverluste Diode-Wechselr. (typisch)  
switching losses diode-inverter (typical)  
 $E_{rec} = f(I_F)$   
 $R_{Gon} = 75 \Omega$ ,  $V_{CE} = 600 V$ ,  $T_{vj} = 125^\circ C$

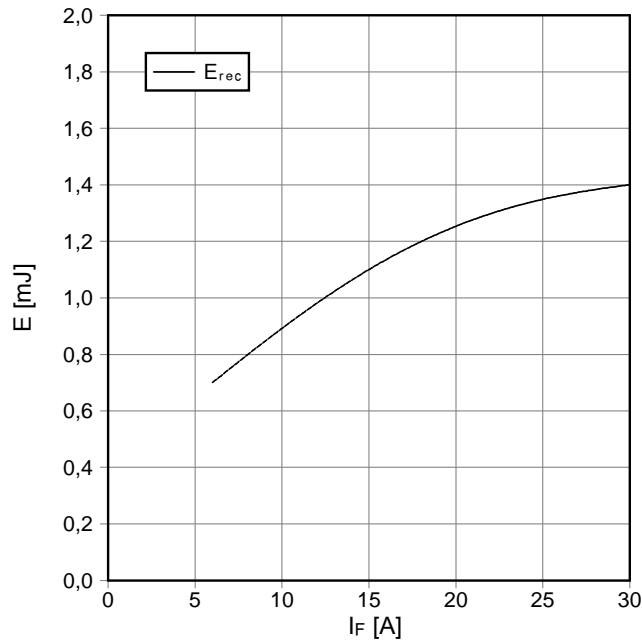

Schaltverluste Diode-Wechselr. (typisch)  
switching losses diode-inverter (typical)  
 $E_{rec} = f(R_G)$   
 $I_F = 15 A$ ,  $V_{CE} = 600 V$ ,  $T_{vj} = 125^\circ C$

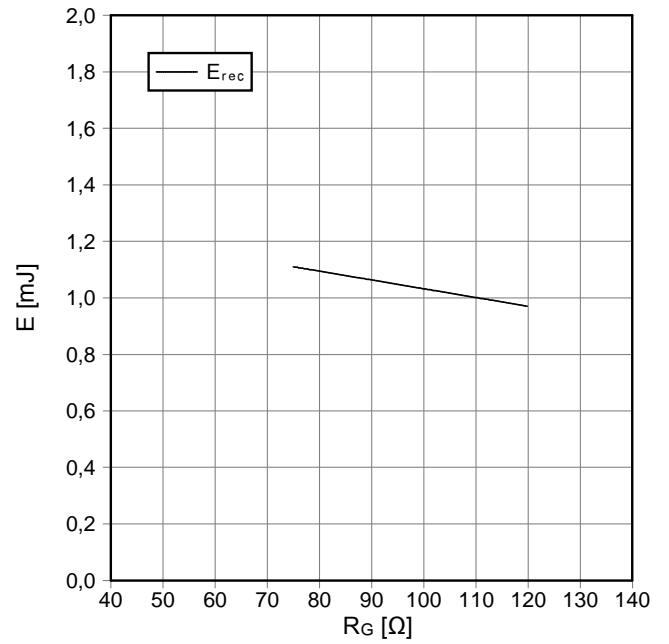

Transienter Wärmewiderstand Diode-Wechselr.  
transient thermal impedance diode-inverter  
 $Z_{thJC} = f(t)$

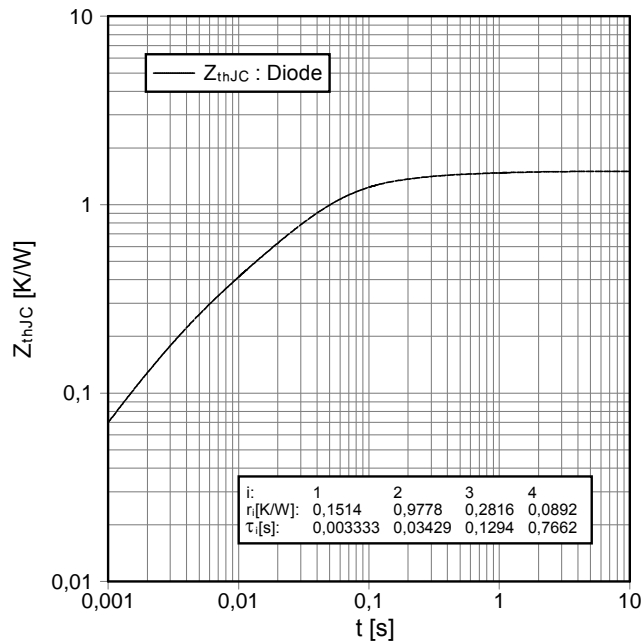

i:	1	2	3	4
r <sub>i</sub> [K/W]:	0,1514	0,9778	0,2816	0,0892
τ <sub>i</sub> [s]:	0,003333	0,03429	0,1294	0,7662

Durchlaßkennlinie der Diode-Gleichrichter (typisch)  
forward characteristic of diode-rectifier (typical)  
 $I_F = f(V_F)$

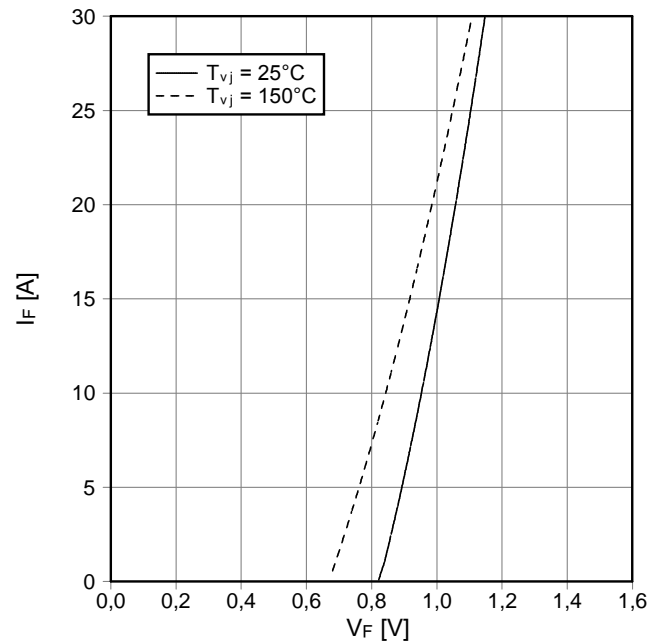

prepared by: Andreas Schulz	date of publication: 2003-12-2
approved by: Robert Severin	revision: 2.1



**Vorläufige Daten**  
**preliminary data**

**Ausgangskennlinie IGBT-Brems-Chopper (typisch)**  
**output characteristic IGBT-brake-chopper (typical)**  
 $I_C = f(V_{CE})$   
 $V_{GE} = 15\text{ V}$

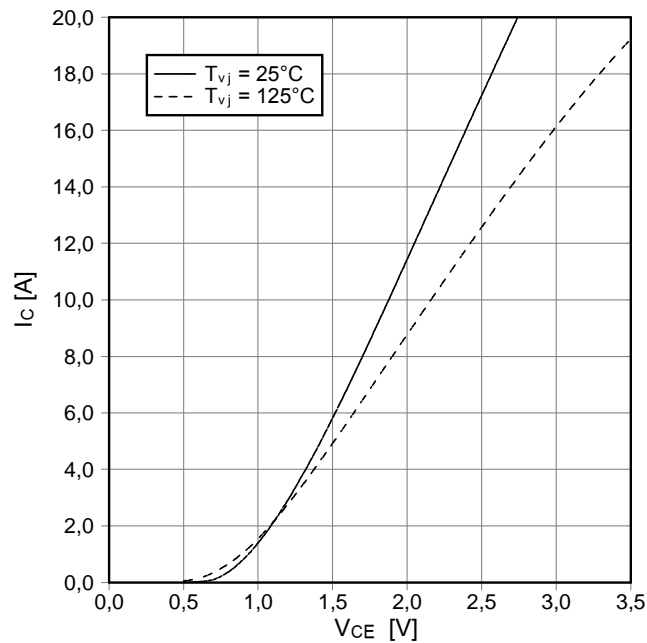

**Durchlaßkennlinie der Diode-Brems-Chopper (typisch)**  
**forward characteristic of diode-brake-chopper (typical)**  
 $I_F = f(V_F)$

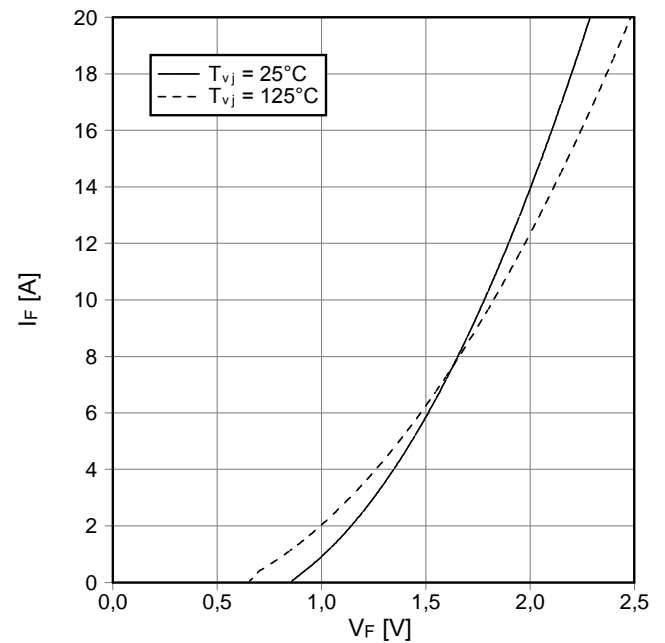

**NTC-Temperaturkennlinie (typisch)**  
**NTC-temperature characteristic (typical)**  
 $R = f(T)$

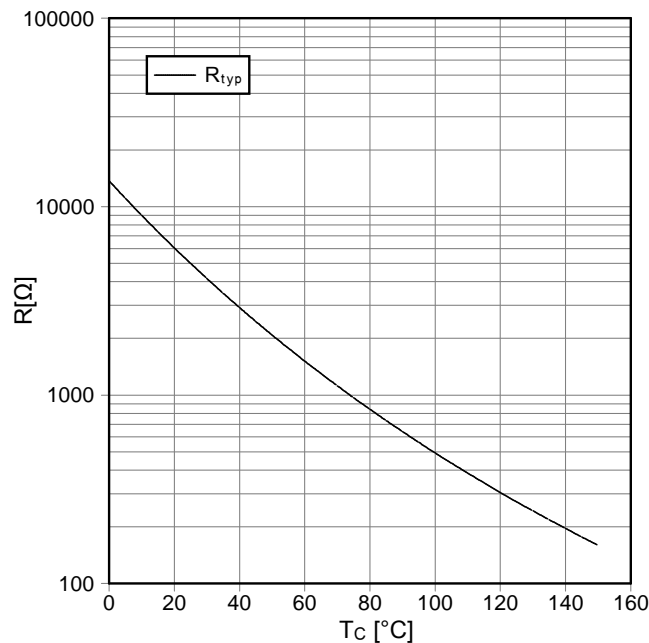

prepared by: Andreas Schulz	date of publication: 2003-12-2
approved by: Robert Severin	revision: 2.1

**Vorläufige Daten**  
preliminary data

## Schaltplan / circuit diagram

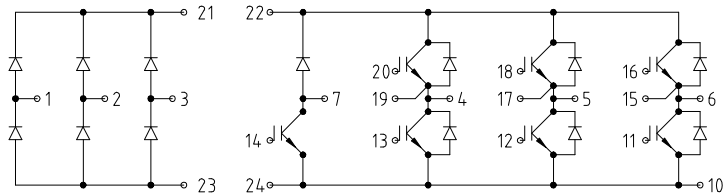

## Gehäuseabmessungen / package outlines

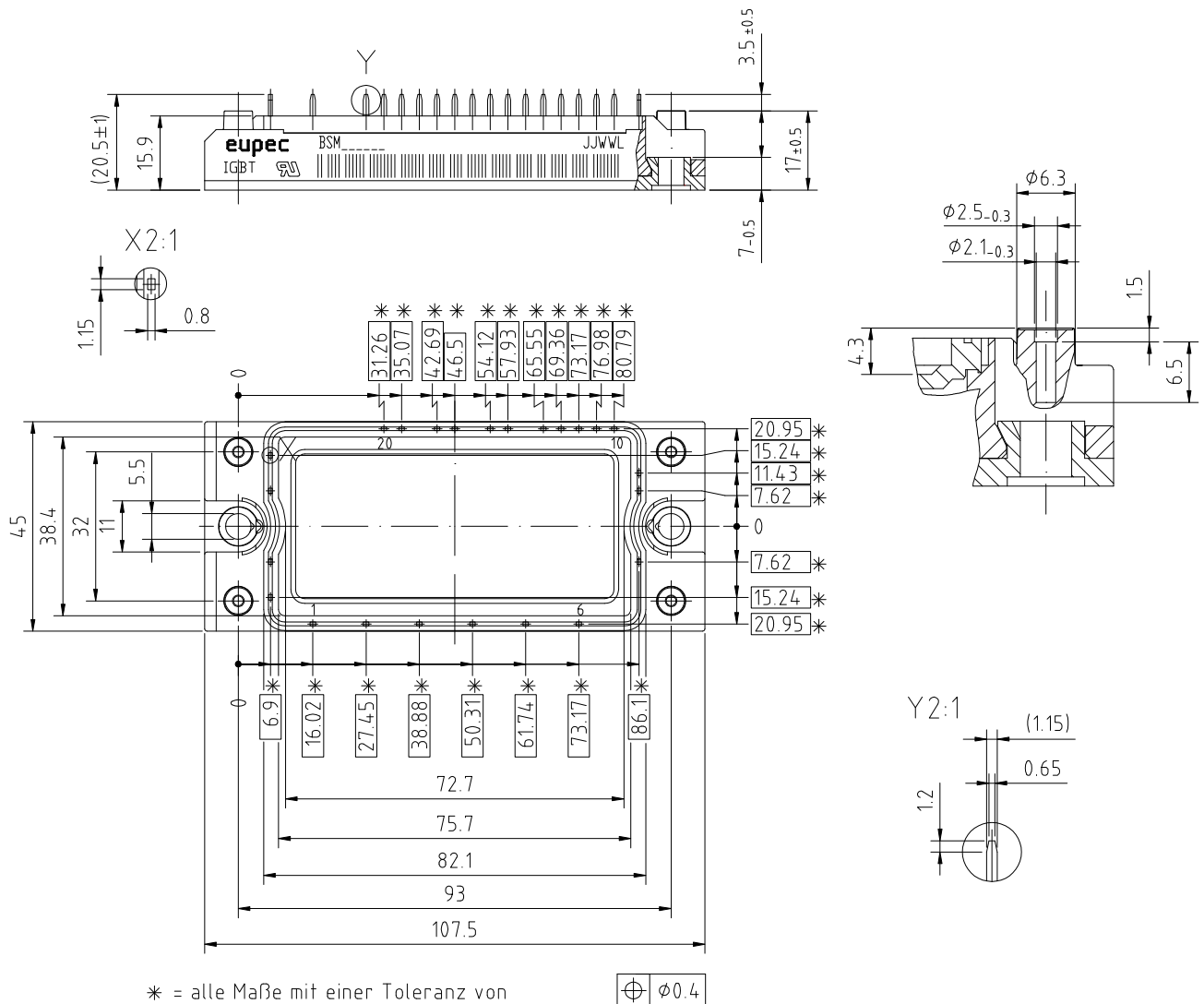

prepared by: Andreas Schulz	date of publication: 2003-12-2
approved by: Robert Severin	revision: 2.1

## **Terms & Conditions of Usage**

### **Attention**

The present product data is exclusively subscribed to technically experienced staff. This Data Sheet is describing the specification of the products for which a warranty is granted exclusively pursuant the terms and conditions of the supply agreement. There will be no guarantee of any kind for the product and its specifications. Changes to the Data Sheet are reserved.

You and your technical departments will have to evaluate the suitability of the product for the intended application and the completeness of the product data with respect to such application. Should you require product information in excess of the data given in the Data Sheet, please contact your local Sales Office via "[www.eupec.com](http://www.eupec.com) / sales & contact".

### **Warning**

Due to technical requirements the products may contain dangerous substances. For information on the types in question please contact your local Sales Office via "[www.eupec.com](http://www.eupec.com) / sales & contact".