



85CNQ015APbF 85CNQ015ASMPbF

SCHOTTKY RECTIFIER
New GenIII D-61 Package

80 Amp

Major Ratings and Characteristics

Characteristics	Values	Units
$I_{F(AV)}$ Rectangular waveform	80	A
V_{RRM}	15	V
I_{FSM} @tp = 5 μ s sine	5200	A
V_F @40Apk, $T_J = 75^\circ\text{C}$ (per leg)	0.32	V
T_J range	-55 to 100	$^\circ\text{C}$

Description/ Features

The center tap Schottky rectifier module has been optimized for ultra low forward voltage drop specifically for the OR-ing of parallel power supplies. The proprietary barrier technology allows for reliable operation up to 125 $^\circ\text{C}$ junction temperature. Typical applications are in parallel switching power supplies, converters, reverse battery protection, and redundant power subsystems.

- 125 $^\circ\text{C}$ T_J operation ($V_R < 5\text{V}$)
- Center tap module
- Optimized for OR-ing applications
- Ultra low forward voltage drop
- High frequency operation
- Guard ring for enhanced ruggedness and long term reliability
- High purity, high temperature epoxy encapsulation for enhanced mechanical strength and moisture resistance
- *New fully transfer-mold low profile, small footprint, high current package*
- Through-hole versions are currently available for use in Lead-Free applications ("PbF" suffix)

Case Styles

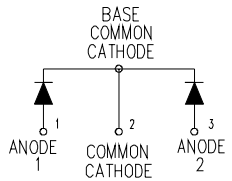
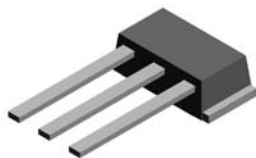
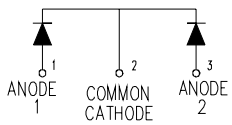
<p>85CNQ015APbF</p>   <p>D61-8</p>	<p>85CNQ015ASMPbF</p>   <p>D61-8-SM</p>
---	--

Voltage Ratings

Part number	85CNQ015A..
V_R Max. DC Reverse Voltage (V)	15
V_{RWM} Max. Working Peak Reverse Voltage (V)	25

Absolute Maximum Ratings

Parameters	85CNQ	Units	Conditions
$I_{F(AV)}$ Max. Average Forward Current * See Fig. 5	80	A	50% duty cycle @ $T_C = 78^\circ\text{C}$, rectangular wave form
I_{FSM} Max. Peak One Cycle Non-Repetitive Surge Current (Per Leg) * See Fig. 7	5200	A	5 μs Sine or 3 μs Rect. pulse
	850		10ms Sine or 6ms Rect. pulse
E_{AS} Non-Repetitive Avalanche Energy (Per Leg)	9	mJ	$T_J = 25^\circ\text{C}$, $I_{AS} = 2$ Amps, $L = 4.50$ mH
I_{AR} Repetitive Avalanche Current (Per Leg)	2	A	Current decaying linearly to zero in 1 μsec Frequency limited by T_J max. $V_A = 3 \times V_R$ typical

Electrical Specifications

Parameters	85CNQ	Units	Conditions
V_{FM} Max. Forward Voltage Drop (Per Leg) * See Fig. 1 (1)	0.36	V	@ 40A
	0.45	V	@ 80A
	0.32	V	@ 40A
	0.42	V	@ 80A
I_{RM} Max. Reverse Leakage Current (Per Leg) * See Fig. 2 (1)	20	mA	$T_J = 25^\circ\text{C}$
	1000	mA	$T_J = 100^\circ\text{C}$
	890	mA	$T_J = 100^\circ\text{C}$
	540	mA	$T_J = 100^\circ\text{C}$
C_T Max. Junction Capacitance (Per Leg)	3600	pF	$V_R = 5V_{DC}$, (test signal range 100Khz to 1Mhz) 25°C
L_S Typical Series Inductance (Per Leg)	5.5	nH	Measured lead to lead 5mm from package body
dv/dt Max. Voltage Rate of Change (Rated V_R)	10000	V/ μs	

(1) Pulse Width < 300 μs , Duty Cycle < 2%

Thermal-Mechanical Specifications

Parameters	85CNQ	Units	Conditions
T_J Max. Junction Temperature Range	-55 to 125	$^\circ\text{C}$	
T_{stg} Max. Storage Temperature Range	-55 to 150	$^\circ\text{C}$	
R_{thJC} Max. Thermal Resistance Junction to Case (Per Leg)	0.85	$^\circ\text{C}/\text{W}$	DC operation * See Fig. 4
R_{thJC} Max. Thermal Resistance Junction to Case (Per Package)	0.42	$^\circ\text{C}/\text{W}$	DC operation
R_{thCS} Typical Thermal Resistance, Case to Heatsink (D61-8 Only)	0.30	$^\circ\text{C}/\text{W}$	Mounting surface, smooth and greased Device flatness < 5 mils
wt Approximate Weight	7.8 (0.28)	g (oz.)	
T Mounting Torque (D61-8 Only)	Min.	40 (35)	Kg-cm (lbf-in)
	Max.	58 (50)	

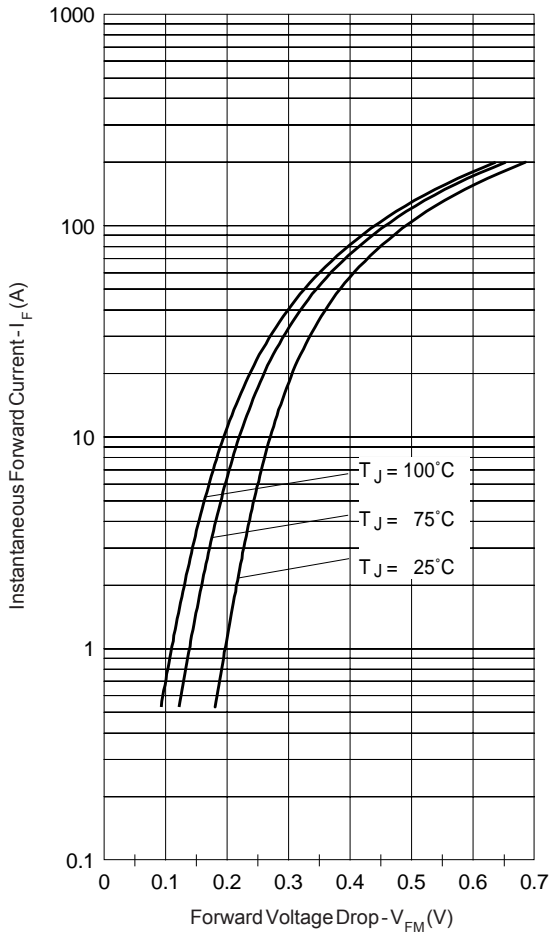

Fig. 1 - Max. Forward Voltage Drop Characteristics (Per Leg)

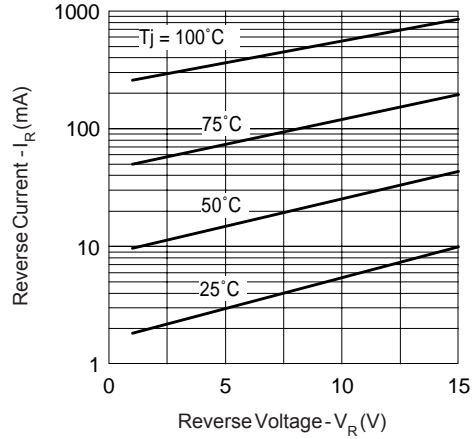

Fig. 2 - Typical Values Of Reverse Current Vs. Reverse Voltage (Per Leg)

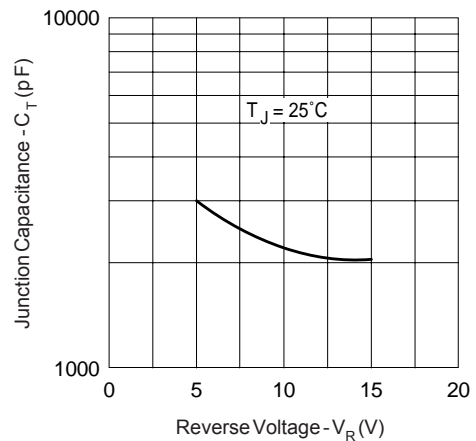

Fig. 3 - Typical Junction Capacitance Vs. Reverse Voltage (Per Leg)

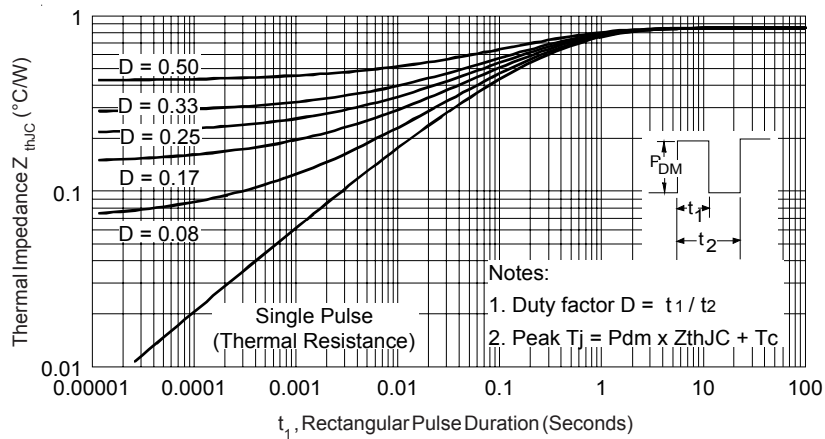

Fig. 4 - Max. Thermal Impedance Z_{thJC} Characteristics (Per Leg)

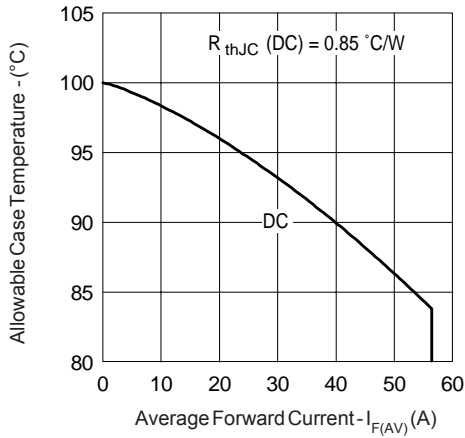

Fig. 5 - Max. Allowable Case Temperature Vs. Average Forward Current (Per Leg)

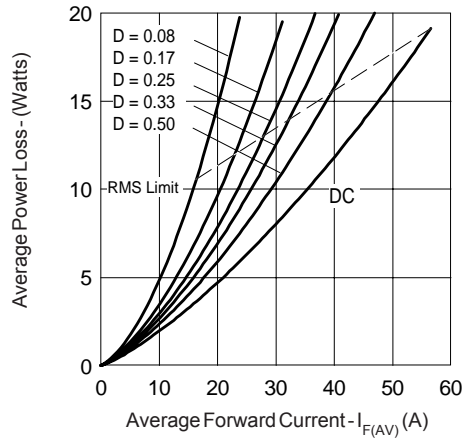

Fig. 6 - Forward Power Loss Characteristics (Per Leg)

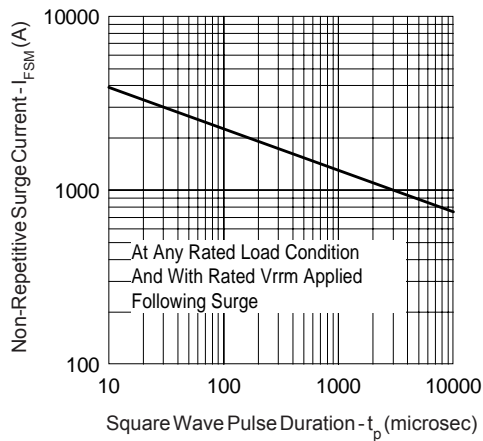

Fig. 7 - Max. Non-Repitative Surge Current (Per Leg)

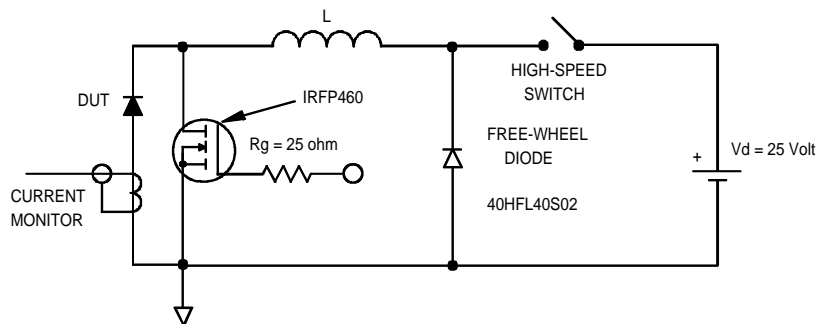
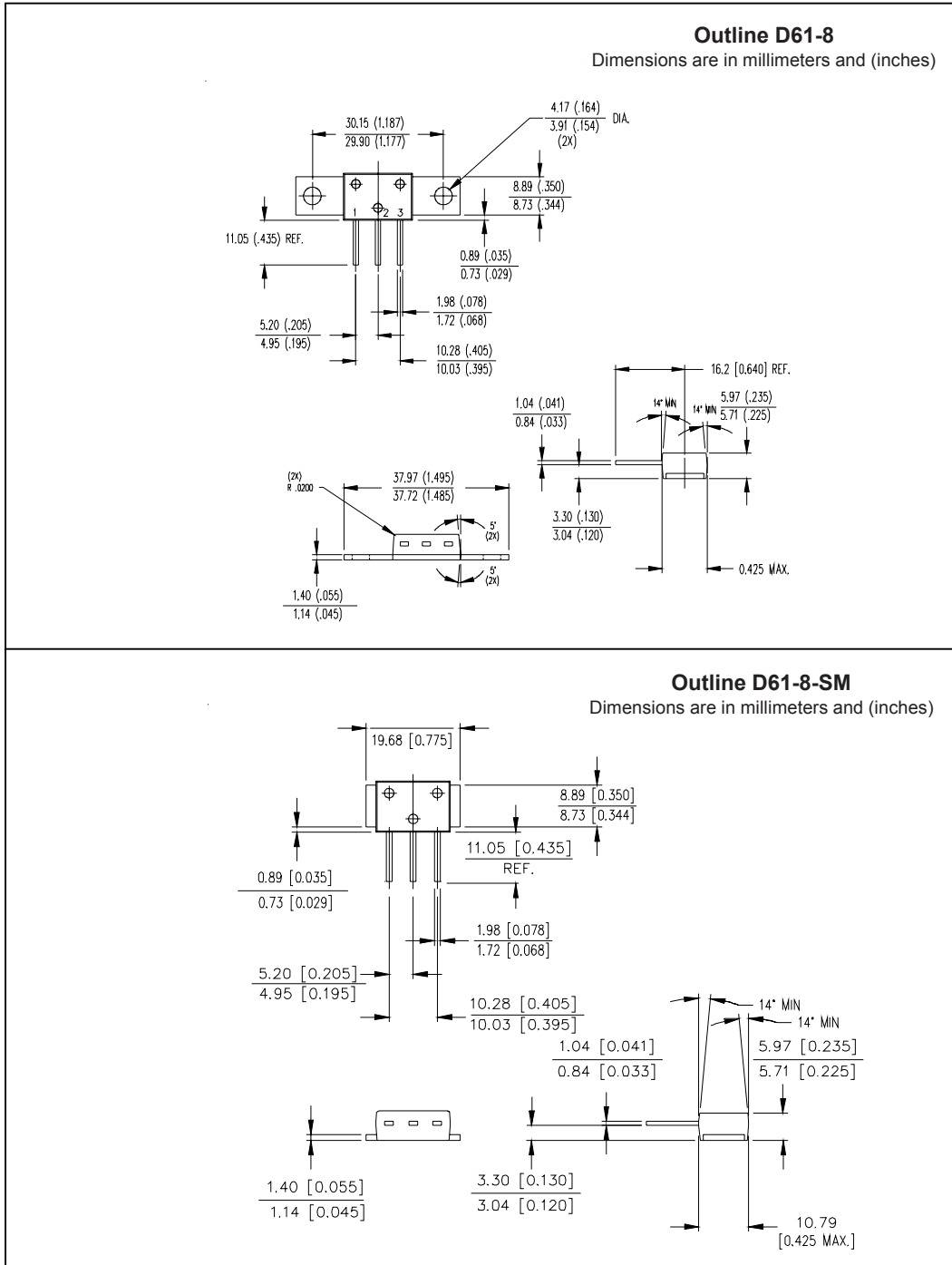

Fig. 8 - Unclamped Inductive Test Circuit

Outline Table



Outline D61-8-SM
 Dimensions are in millimeters and (inches)

Marking Information

Outline D61-8

EXAMPLE: THIS IS A 85CNQ015 WITH
 LOT CODE 89 09
 ASSEMBLED ON WW 45, 2000

Note: "P" in assembly line
 position indicates "Lead-Free"

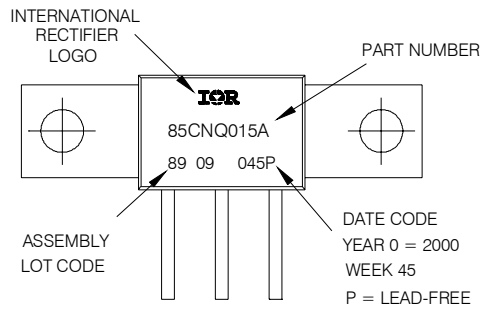

Outline D61-8-SM

EXAMPLE: THIS IS A 85CNQ015ASM WITH
 LOT CODE 89 09
 ASSEMBLED ON WW 45, 2000

Note: "P" in assembly line
 position indicates "Lead-Free"

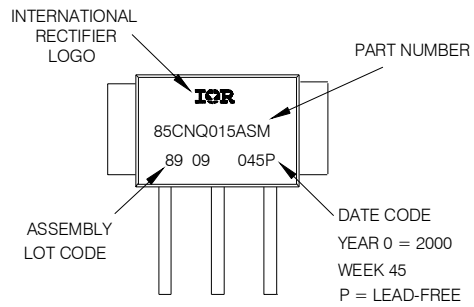

Ordering Information Table

Device Code						
85	C	N	Q	015	A	PbF
①	②	③	④	⑤	⑥	⑦
1	- Current Rating (80A)					
2	- Circuit Configuration C = Common Cathode					
3	- Package N = D-61					
4	- Schottky "Q" Series					
5	- Voltage Rating (015 = 15V)					
6	- • A = D-61-8 package style • ASM = D-61-8-SM package style					
7	- • none = Standard Production • PbF = Lead-Free					
Standard pack quantity: A = 10 pieces ASM = 20 pieces						

Data and specifications subject to change without notice.
 This product has been designed and qualified for Industrial Level and Lead-Free.
 Qualification Standards can be found on IR's Web site.