

SCHOTTKY RECTIFIER New GenIII D-61 Package

80 Amp

Major Ratings and Characteristics

Characteristics	85CNQ015A	Units
$I_{F(AV)}$ Rectangular waveform	80	A
V_{RRM}	15	V
I_{FSM} @ tp = 5 μ s sine	5200	A
V_F @40Apk, $T_J=75^\circ\text{C}$ (per leg)	0.32	V
T_J range	-55 to 100	$^\circ\text{C}$

Description/Features

The 85CNQ015A center tap Schottky rectifier module has been optimized for ultra low forward voltage drop specifically for the OR-ing of parallel power supplies. The proprietary barrier technology allows for reliable operation up to 125 $^\circ\text{C}$ junction temperature. Typical applications are in parallel switching power supplies, converters, reverse battery protection, and redundant power subsystems.

- 125 $^\circ\text{C}$ T_J operation ($V_R < 5\text{V}$)
- Center tap module
- Optimized for OR-ing applications
- Ultra low forward voltage drop
- High frequency operation
- Guard ring for enhanced ruggedness and long term reliability
- High purity, high temperature epoxy encapsulation for enhanced mechanical strength and moisture resistance
- *New fully transfer-mold low profile, small footprint, high current package*

Case Styles

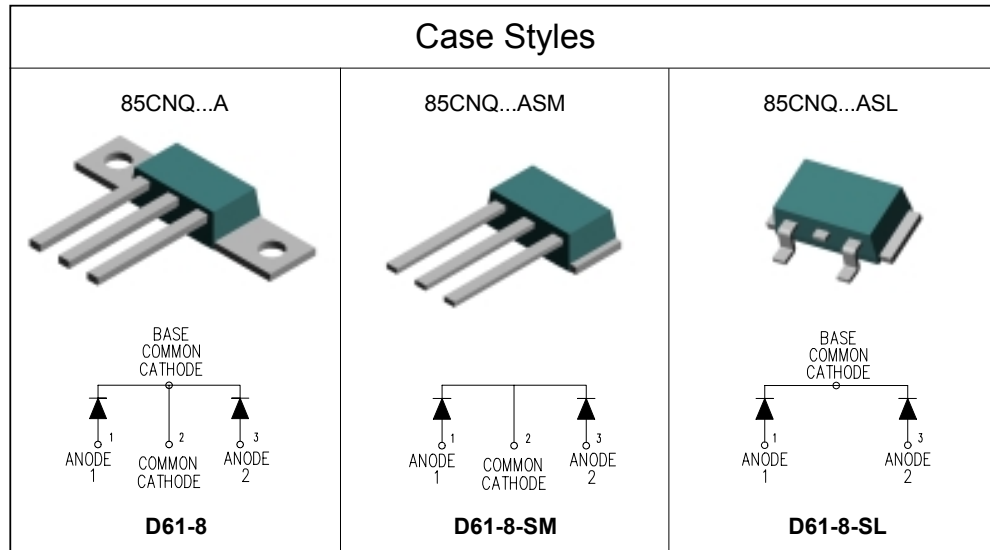

85CNQ015A

Bulletin PD-20044 rev. B 09/01

International
IRF Rectifier

Voltage Ratings

Part number	85CNQ015A
V_R Max. DC Reverse Voltage (V)	15
V_{RWM} Max. Working Peak Reverse Voltage (V)	25

Absolute Maximum Ratings

Parameters	85CNQ	Units	Conditions
$I_{F(AV)}$ Max. Average Forward Current * See Fig. 5	80	A	50% duty cycle @ $T_C = 78^\circ\text{C}$, rectangular waveform
I_{FSM} Max. Peak One Cycle Non-Repetitive Surge Current (Per Leg) * See Fig. 7	5200	A	Following any rated load condition and with rated V_{RWM} applied
	850		
E_{AS} Non-Repetitive Avalanche Energy (Per Leg)	9	mJ	$T_J = 25^\circ\text{C}$, $I_{AS} = 2$ Amps, $L = 4.50$ mH
I_{AR} Repetitive Avalanche Current (Per Leg)	2	A	Current decaying linearly to zero in 1 μsec Frequency limited by T_J , max. $V_A = 3 \times V_R$ typical

Electrical Specifications

Parameters	85CNQ	Units	Conditions
V_{FM} Max. Forward Voltage Drop (Per Leg) * See Fig. 1 (1)	0.36	V	@ 40A
	0.45	V	@ 80A
	0.32	V	@ 40A
	0.42	V	@ 80A
I_{RM} Max. Reverse Leakage Current (Per Leg) * See Fig. 2 (1)	20	mA	$T_J = 25^\circ\text{C}$
	1000	mA	$T_J = 100^\circ\text{C}$
	890	mA	$T_J = 100^\circ\text{C}$
	540	mA	$T_J = 100^\circ\text{C}$
C_T Max. Junction Capacitance (Per Leg)	3600	pF	$V_R = 5V_{DC}$, (test signal range 100Khz to 1Mhz) 25°C
L_S Typical Series Inductance (Per Leg)	5.5	nH	Measured lead to lead 5mm from package body
dv/dt Max. Voltage Rate of Change (Rated V_R)	10000	V/ μs	

(1) Pulse Width < 300 μs , Duty Cycle < 2%

Thermal-Mechanical Specifications

Parameters	85CNQ	Units	Conditions
T_J Max. Junction Temperature Range	-55 to 125	$^\circ\text{C}$	
T_{stg} Max. Storage Temperature Range	-55 to 150	$^\circ\text{C}$	
R_{thJC} Max. Thermal Resistance Junction to Case (Per Leg)	0.85	$^\circ\text{C/W}$	DC operation * See Fig. 4
R_{thJC} Max. Thermal Resistance Junction to Case (Per Package)	0.42	$^\circ\text{C/W}$	DC operation
R_{thCS} Typical Thermal Resistance, Case to Heatsink (D61-8 Only)	0.30	$^\circ\text{C/W}$	Mounting surface, smooth and greased Device flatness < 5 mils
wt Approximate Weight	7.8(0.28)	g(oz.)	
T Mounting Torque	Min. 40(35) Max. 58(50)	Kg-cm (lbf-in)	

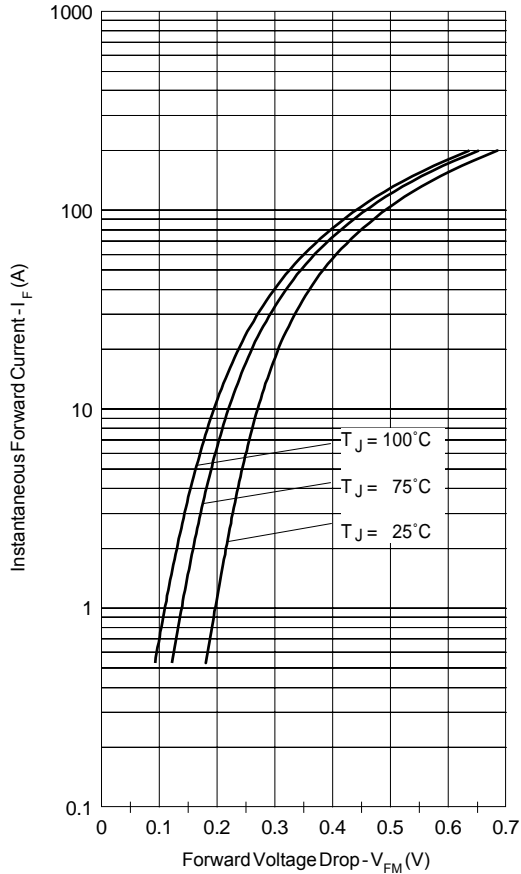

Fig. 1 - Max. Forward Voltage Drop Characteristics (PerLeg)

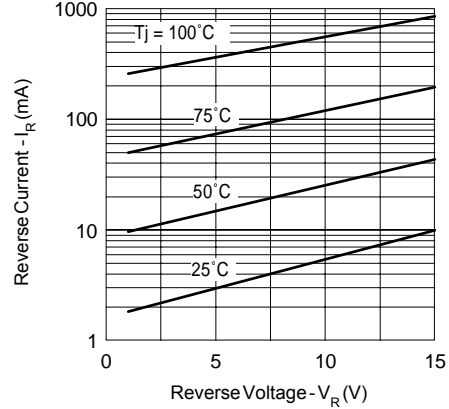

Fig. 2 - Typical Values Of Reverse Current Vs. Reverse Voltage (PerLeg)

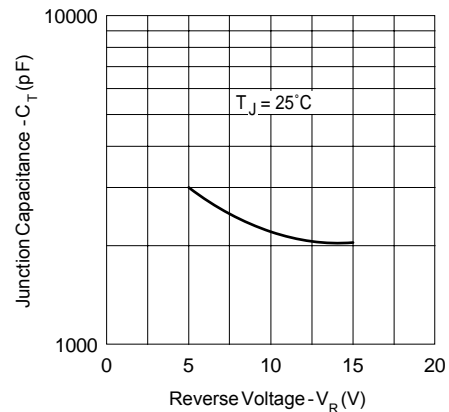

Fig. 3 - Typical Junction Capacitance Vs. Reverse Voltage (PerLeg)

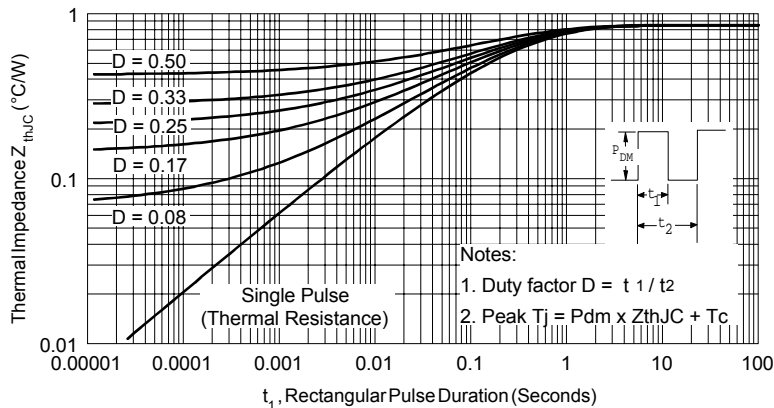

Fig. 4 - Max. Thermal Impedance Z_{thJC} Characteristics (PerLeg)

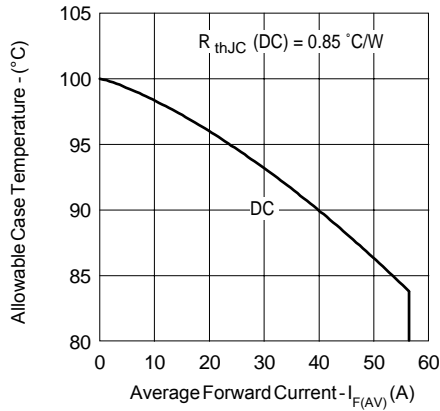

Fig. 5 - Max. Allowable Case Temperature Vs. Average Forward Current (Per Leg)

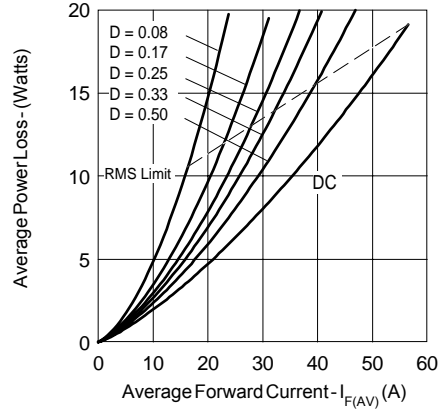

Fig. 6 - Forward Power Loss Characteristics (Per Leg)

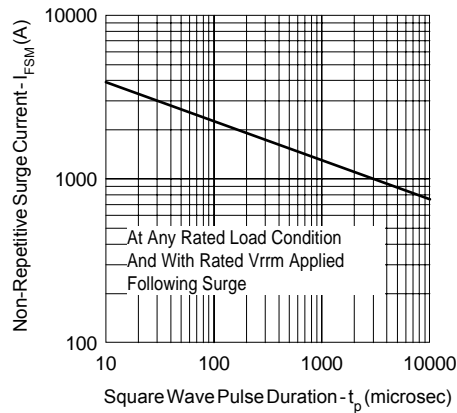

Fig. 7 - Max. Non-Repetitive Surge Current (Per Leg)

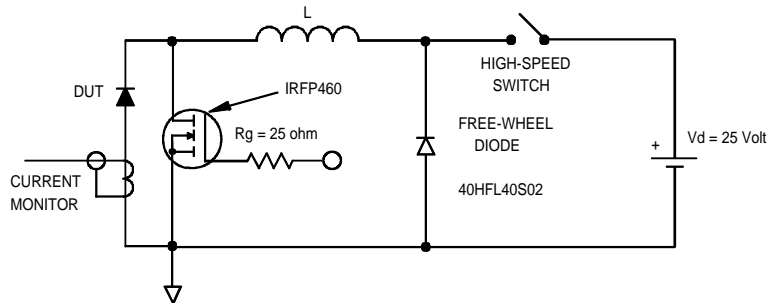
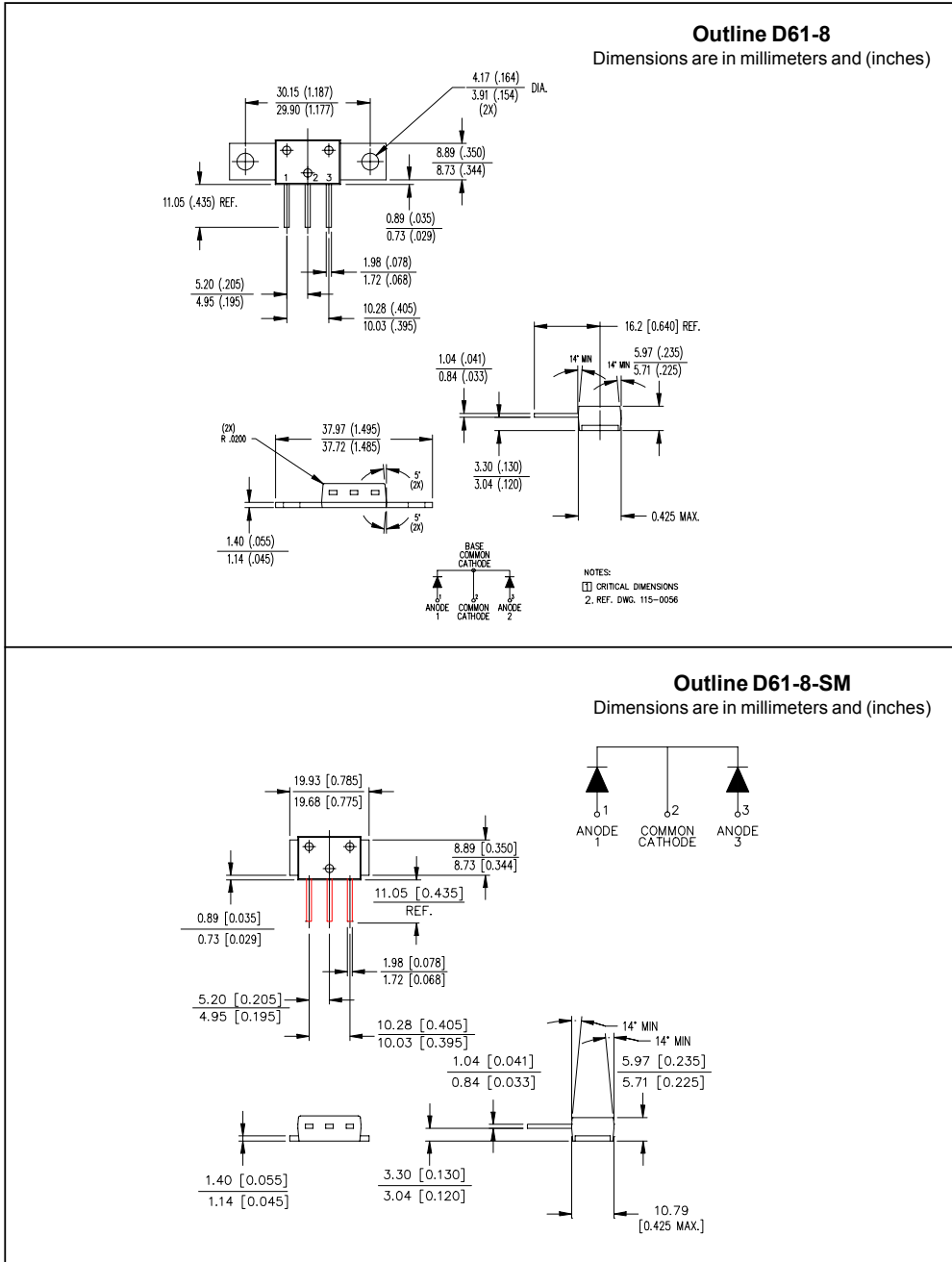
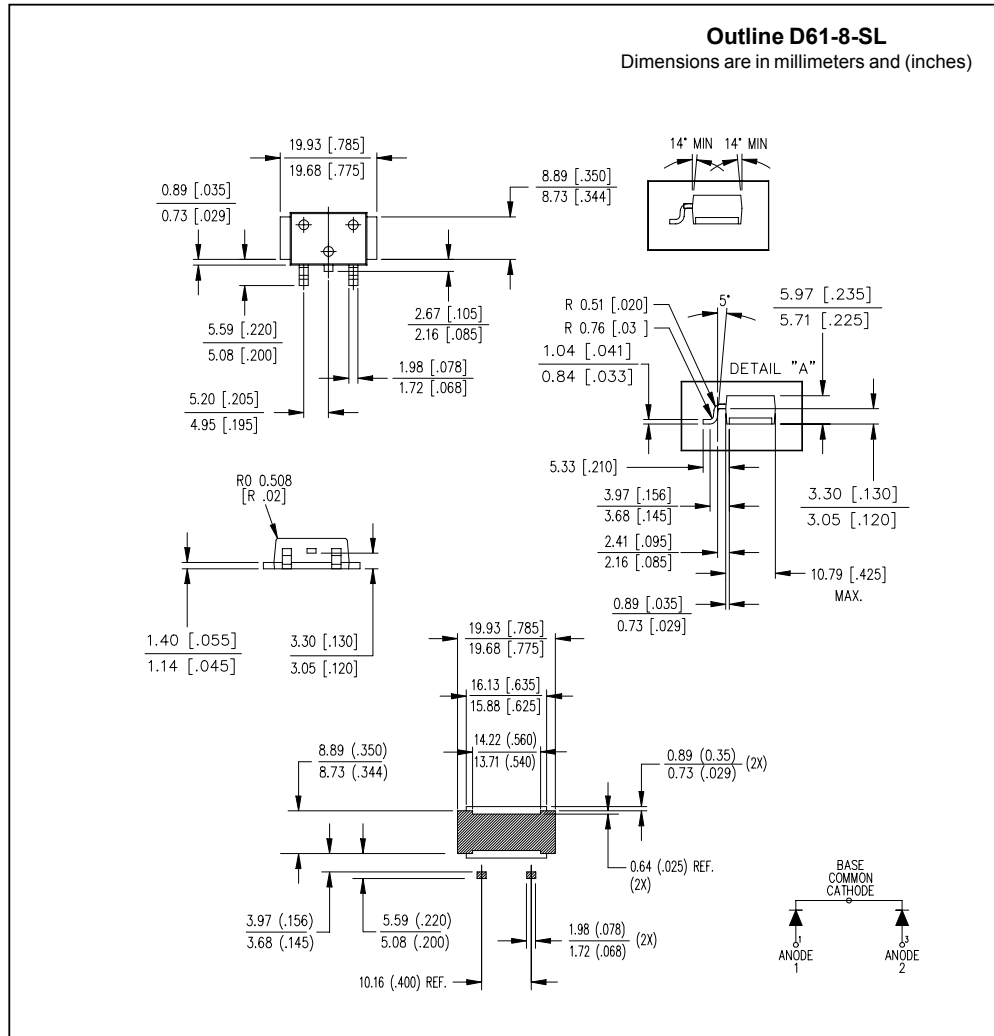

Fig. 8 - Unclamped Inductive Test Circuit

Outline Table



Outline Table

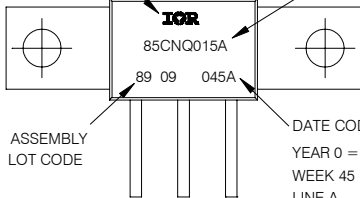
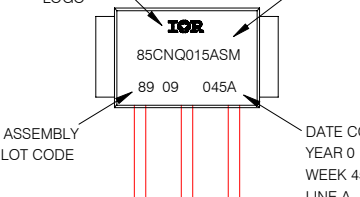
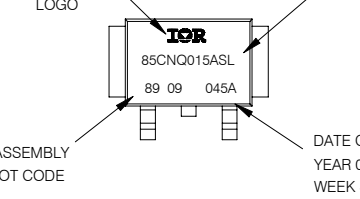

Part Marking Information

<p>EXAMPLE: THIS IS A 85CNQ015A WITH LOT CODE 89 09 ASSEMBLED ON WW 45, 2000 IN THE ASSEMBLY LINE "A"</p>	 <p>INTERNATIONAL RECTIFIER LOGO</p> <p>PART NUMBER</p> <p>85CNQ015A</p> <p>89 09 045A</p> <p>ASSEMBLY LOT CODE</p> <p>DATE CODE YEAR 0 = 2000 WEEK 45 LINE A</p>
<p>D61-8</p>	
<p>EXAMPLE: THIS IS A 85CNQ015ASM WITH LOT CODE 89 09 ASSEMBLED ON WW 45, 2000 IN THE ASSEMBLY LINE "A"</p>	 <p>INTERNATIONAL RECTIFIER LOGO</p> <p>PART NUMBER</p> <p>85CNQ015ASM</p> <p>89 09 045A</p> <p>ASSEMBLY LOT CODE</p> <p>DATE CODE YEAR 0 = 2000 WEEK 45 LINE A</p>
<p>D61-8-SM</p>	
<p>EXAMPLE: THIS IS A 85CNQ015ASL WITH LOT CODE 89 09 ASSEMBLED ON WW 45, 2000 IN THE ASSEMBLY LINE "A"</p>	 <p>INTERNATIONAL RECTIFIER LOGO</p> <p>PART NUMBER</p> <p>85CNQ015ASL</p> <p>89 09 045A</p> <p>ASSEMBLY LOT CODE</p> <p>DATE CODE YEAR 0 = 2000 WEEK 45 LINE A</p>
<p>D61-8-SL</p>	

85CNQ015A

Bulletin PD-20044 rev. B 09/01

International
IOR Rectifier

Data and specifications subject to change without notice.
This product has been designed and qualified for Industrial Level.
Qualification Standards can be found on IR's Web site.

International
IOR Rectifier

IR WORLD HEADQUARTERS: 233 Kansas St., El Segundo, California 90245, USA Tel: (310) 252-7105
TAC Fax: (310) 252-7309

Visit us at www.irf.com for sales contact information. 09/01