

SK 120 KQ



SEMITOP® 2

Antiparallel Thyristor Module

SK 120 KQ

Preliminary Data

Features

- Compact Design
- One screw mounting
- Heat transfer and isolation through direct copper bonded aluminium oxide ceramic (DBC)
- Glass passivated thyristor chips
- Up to 1600V reverse voltage
- UL recognized, file no. E 63 532

Typical Applications

- Soft starters
- Light control (studios, theaters...)
- Temperature control

V_{RSM} V	V_{RRM}, V_{DRM} V	$I_{RMS} = 134 \text{ A (full conduction)}$ ($T_s = 85^\circ \text{C}$)
900	800	SK 100 KQ 08
1300	1200	SK 100 KQ 12
1700	1600	SK 100 KQ 16

Symbol	Conditions	Values	Units
I_{RMS}	W1C ; sin. 180° ; $T_s = 100^\circ \text{C}$	94	A
	W1C ; sin. 180° ; $T_s = 85^\circ \text{C}$	134	A
I_{TSM}	$T_{vj} = 25^\circ \text{C}$; 10 ms	2000	A
	$T_{vj} = 125^\circ \text{C}$; 10 ms	1800	A
i^2t	$T_{vj} = 25^\circ \text{C}$; 8,3...10 ms	20000	A ² s
	$T_{vj} = 125^\circ \text{C}$; 8,3...10 ms	16200	A ² s
V_T	$T_{vj} = 25^\circ \text{C}$, $I_T = 300 \text{ A}$	max. 1,85	V
$V_{T(TO)}$	$T_{vj} = 125^\circ \text{C}$	max. 0,9	V
r_T	$T_{vj} = 125^\circ \text{C}$	max. 3,5	mΩ
I_{DD}, I_{RD}	$T_{vj} = 25^\circ \text{C}$, $V_{RD} = V_{RRM}$	max. 1	mA
	$T_{vj} = 125^\circ \text{C}$, $V_{RD} = V_{RRM}$	max. 20	mA
t_{gd}	$T_{vj} = 25^\circ \text{C}$, $I_G = 1 \text{ A}$; $di_G/dt = 1 \text{ A}/\mu\text{s}$	1	μs
t_{gr}	$V_D = 0,67 * V_{DRM}$	2	μs
$(dv/dt)_{cr}$	$T_{vj} = 125^\circ \text{C}$	1000	V/μs
$(di/dt)_{cr}$	$T_{vj} = 125^\circ \text{C}$; $f = 50...60 \text{ Hz}$	100	A/μs
t_q	$T_{vj} = 125^\circ \text{C}$; typ.	80	μs
I_H	$T_{vj} = 25^\circ \text{C}$; typ. / max.	100 / 200	mA
I_L	$T_{vj} = 25^\circ \text{C}$; $R_G = 33 \Omega$; typ. / max.	200 / 500	mA
V_{GT}	$T_{vj} = 25^\circ \text{C}$; d.c.	min. 2	V
I_{GT}	$T_{vj} = 25^\circ \text{C}$; d.c.	min. 100	mA
V_{GD}	$T_{vj} = 125^\circ \text{C}$; d.c.	max. 0,25	V
I_{GD}	$T_{vj} = 125^\circ \text{C}$; d.c.	max. 5	mA
$R_{th(j-s)}$	cont. per thyristor	0,45	K/W
	sin 180° per thyristor	0,47	K/W
$R_{th(j-s)}$	cont. per W1C	0,225	K/W
	sin 180° per W1C	0,235	K/W
T_{vj}		-40 ... +125	°C
T_{stg}		-40 ... +125	°C
T_{solder}	terminals, 10s	260	°C
V_{isol}	a. c. 50 Hz ; r.m.s. ; 1 s / 1 min.	3000 / 2500	V~
M_s	Mounting torque to heatsink	2,0	Nm
M_t			Nm
a			m/s ²
m		19	g
Case	SEMITOP® 2	T 2	

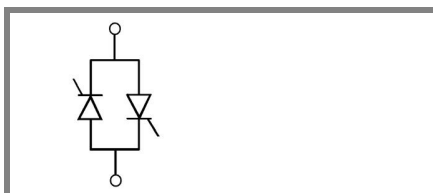

KQ

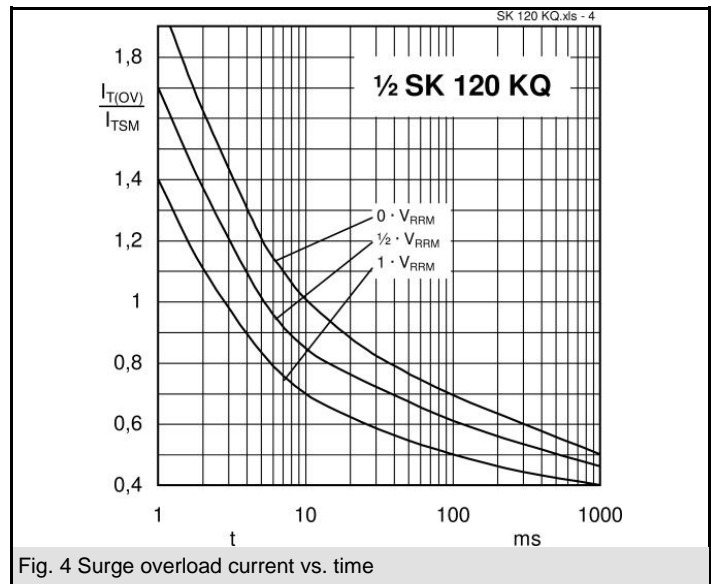
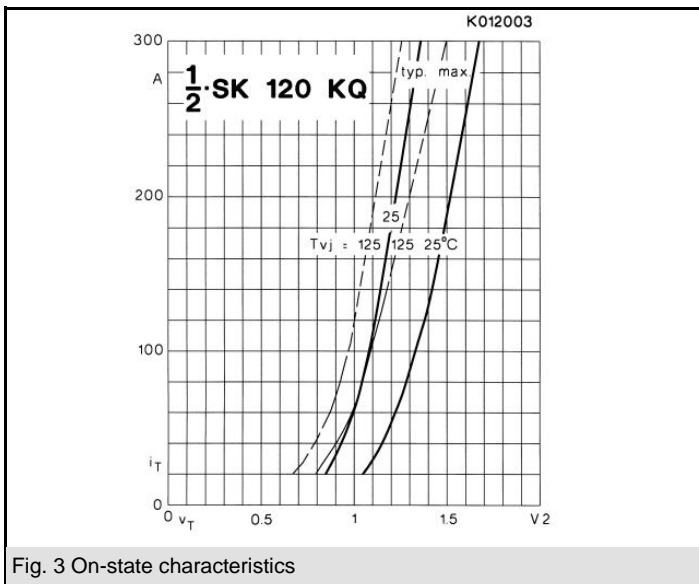
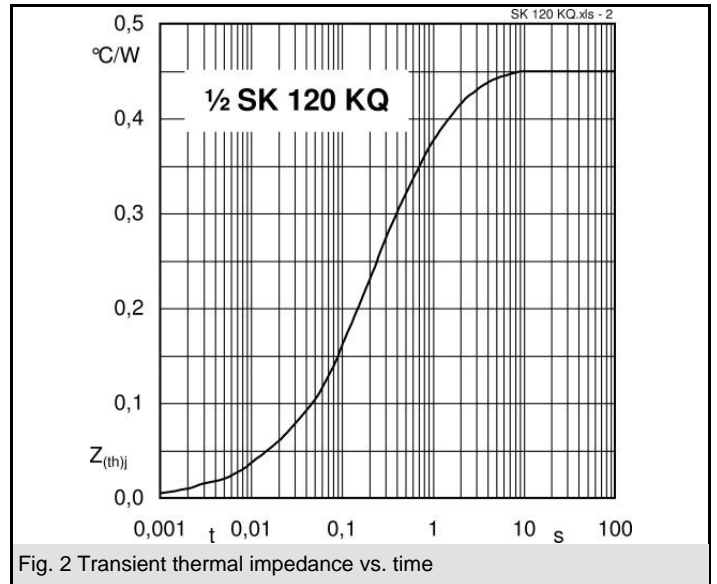
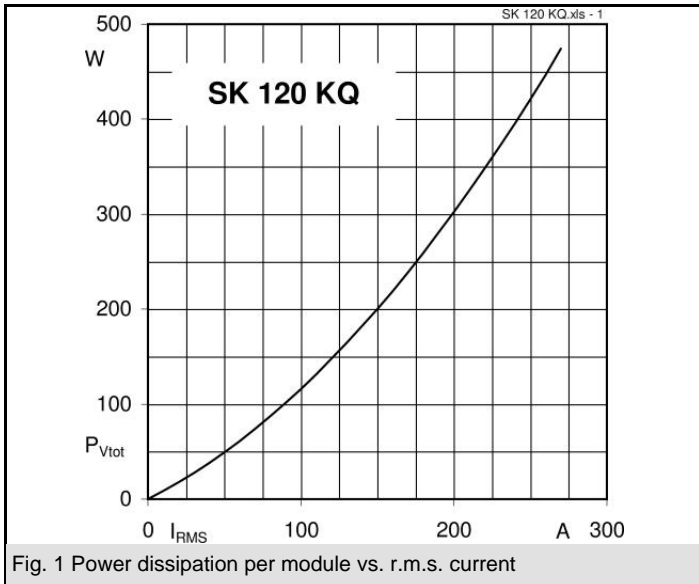

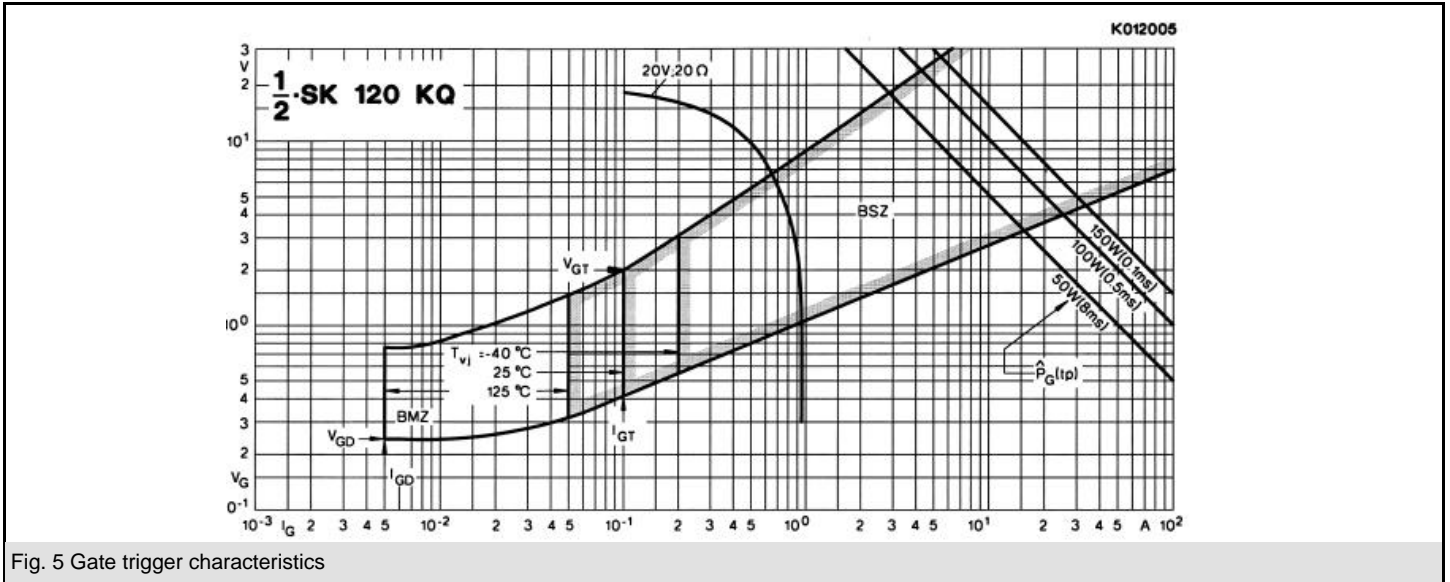
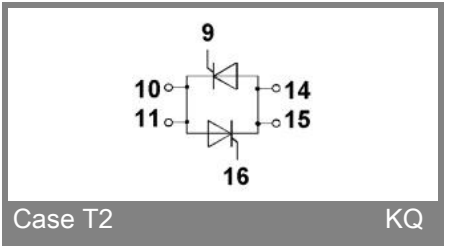
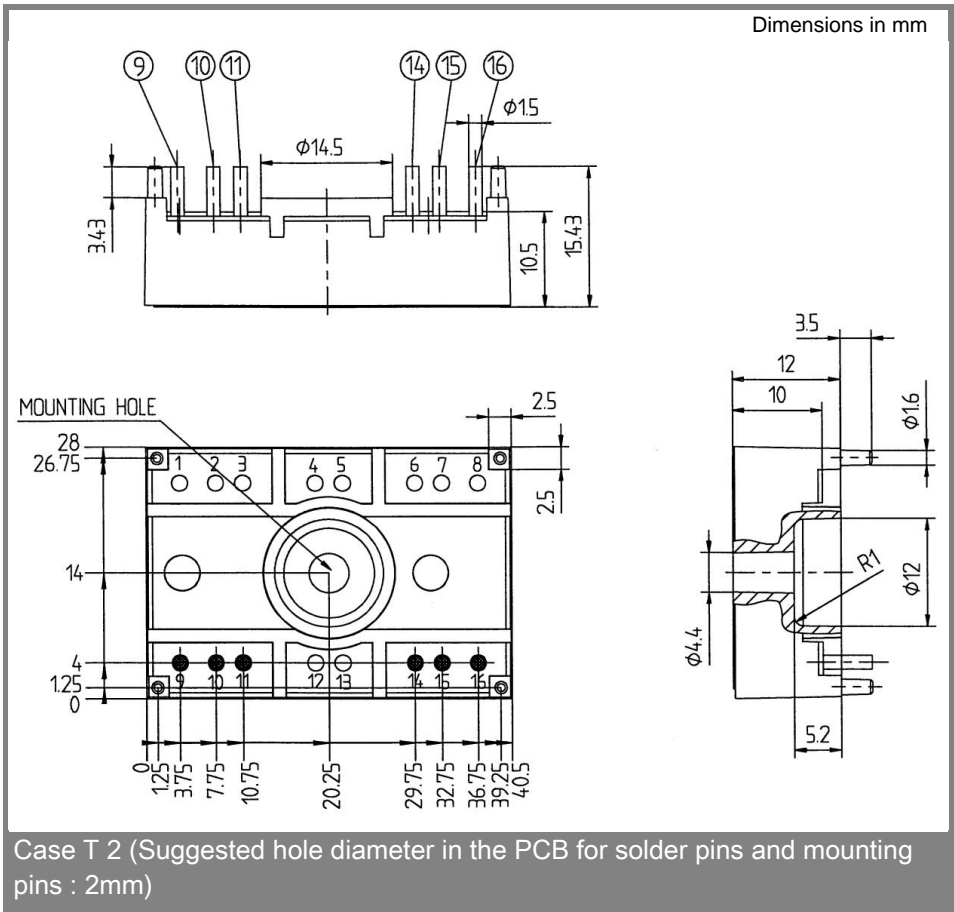

Fig. 5 Gate trigger characteristics



This technical information specifies semiconductor devices but promises no characteristics. No warranty or guarantee expressed or implied is made regarding delivery, performance or suitability.