

MITSUBISHI THYRISTOR MODULES

# TM20RA-M,-H

MEDIUM POWER GENERAL USE  
INSULATED TYPE

TM20RA-M,-H



- **IT (AV)** Average on-state current ..... **20A**
- **IF (AV)** Average forward current ..... **20A**
- **VRRM** Repetitive peak reverse voltage  
..... **400/800V**
- **VDRM** Repetitive peak off-state voltage  
..... **400/800V**
- **MIX DOUBLE ARMS**
- **Insulated Type**
- **UL Recognized**

Yellow Card No. E80276 (N)

File No. E80271

## APPLICATION

DC motor control, NC equipment, Inverters, Servo drives, contactless switches,  
electric furnace temperature control, light dimmers

## OUTLINE DRAWING & CIRCUIT DIAGRAM

Dimensions in mm

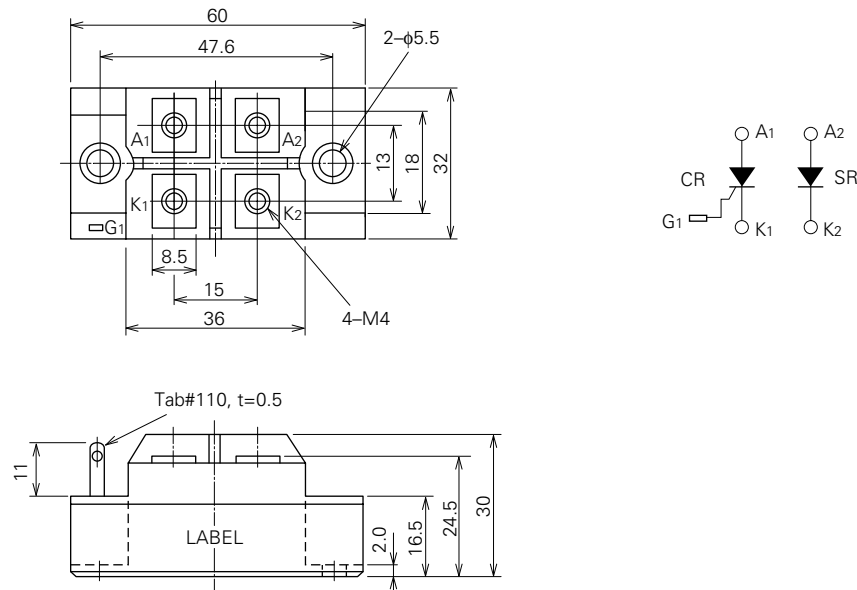

Feb.1999

# TM20RA-M,-H

MEDIUM POWER GENERAL USE  
INSULATED TYPE

## ABSOLUTE MAXIMUM RATINGS

Symbol	Parameter	Voltage class		Unit
		M	H	
VRRM	Repetitive peak reverse voltage	400	800	V
VRSM	Non-repetitive peak reverse voltage	480	960	V
VR (DC)	DC reverse voltage	320	640	V
VDRM	Repetitive peak off-state voltage	400	800	V
VDSM	Non-repetitive peak off-state voltage	480	960	V
VD (DC)	DC off-state voltage	320	640	V

Symbol	Parameter	Conditions	Ratings	Unit
IT (RMS), IF (RMS)	RMS current		30	A
IT (AV), IF (AV)	Average current	Single-phase, half-wave 180° conduction, Tc=87°C	20	A
ITSM, IFSM	Surge (non-repetitive) current	One half cycle at 60Hz, peak value	400	A
I <sup>2</sup> t	I <sup>2</sup> t for fusing	Value for one cycle of surge current	6.7 × 10 <sup>2</sup>	A <sup>2</sup> s
di/dt	Critical rate of rise of on-state current	VD=1/2VDRM, IG=0.5A, Tj=125°C	100	A/μs
PGM	Peak gate power dissipation		5.0	W
PG (AV)	Average gate power dissipation		0.5	W
VFGM	Peak gate forward voltage		10	V
VRGM	Peak gate reverse voltage		5.0	V
IFGM	Peak gate forward current		2.0	A
Tj	Junction temperature		-40~125	°C
Tstg	Storage temperature		-40~125	°C
Viso	Isolation voltage	Charged part to case	2500	V
—	Mounting torque	Main terminal screw M4	0.98~1.47	N·m
			10~15	kg·cm
		Mounting screw M5	1.47~2.45	N·m
			15~25	kg·cm
—	Weight	Typical value	80	g

## ELECTRICAL CHARACTERISTICS

Symbol	Parameter	Test conditions	Limits			Unit
			Min.	Typ.	Max.	
IRRM	Repetitive peak reverse current	Tj=125°C, VRRM applied	—	—	4.0	mA
IDRM	Repetitive peak off-state current	Tj=125°C, VDRM applied	—	—	4.0	mA
VTM, VFM	Forward voltage	Tj=125°C, ITM=IFM=60A, instantaneous meas.	—	—	1.8	V
dv/dt	Critical rate of rise of off-state voltage	Tj=125°C, VD=2/3VDRM	500	—	—	V/μs
VGT	Gate trigger voltage	Tj=25°C, VD=6V, RL=2Ω	—	—	3.0	V
VGD	Gate non-trigger voltage	Tj=125°C, VD=1/2VDRM	0.25	—	—	V
IGT	Gate trigger current	Tj=25°C, VD=6V, RL=2Ω	10	—	50	mA
Rth (j-c)	Thermal resistance	Junction to case (per 1/2 module)	—	—	1.0	°C/W
Rth (c-f)	Contact thermal resistance	Case to fin, conductive grease applied (per 1/2 module)	—	—	0.25	°C/W
—	Insulation resistance	Measured with a 500V megohmmeter between main terminal and case	10	—	—	MΩ

Note: Items of the above table applies to the Thyristor part and the Diode part as circled in the following tables.

# TM20RA-M,-H

MEDIUM POWER GENERAL USE  
INSULATED TYPE

## MAXIMUM RATINGS

Item	VRRM	VRSM	VR (DC)	VDRM	VDSM	VD (DC)	IT (RMS)	IT (AV)	ITSM	$I^2t$	di/dt
							IF (RMS)	IF (AV)	IFSM		
Thyristor	○	○	○	○	○	○	○	○	○	○	○
Diode	○	○	○	—	—	—	○	○	○	○	—

Item	PGM	PG (AV)	VFGM	IFGM	T <sub>j</sub>	T <sub>stg</sub>
Thyristor	○	○	○	○	○	○
Diode	—	—	—	—	○	○

## ELECTRICAL CHARACTERISTICS

Item	IRRMS	IDRM	V <sub>TM</sub>	dv/dt	VGT	VGD	IGT	R <sub>th (j-c)</sub>	R <sub>th (c-f)</sub>
			V <sub>FM</sub>						
Thyristor	○	○	○	○	○	○	○	○	○
Diode	○	—	○	—	—	—	—	○	○

## PERFORMANCE CURVES

MAXIMUM FORWARD CHARACTERISTIC

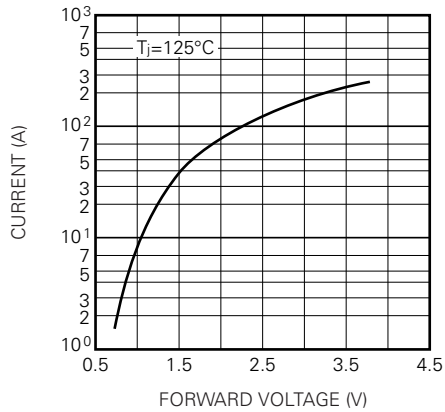

RATED SURGE (NON-REPETITIVE) CURRENT

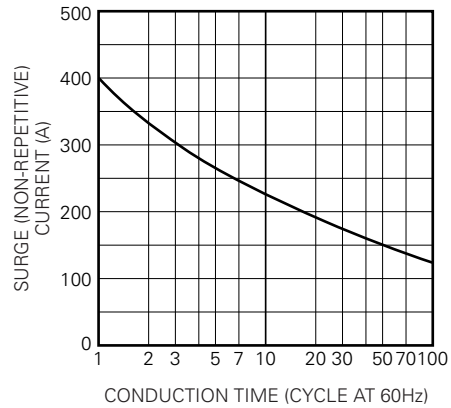

GATE CHARACTERISTICS

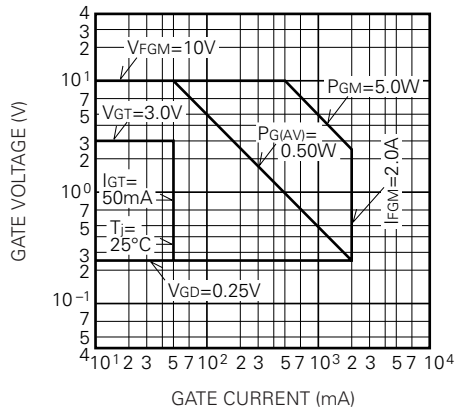

MAXIMUM TRANSIENT THERMAL IMPEDANCE (JUNCTION TO CASE)

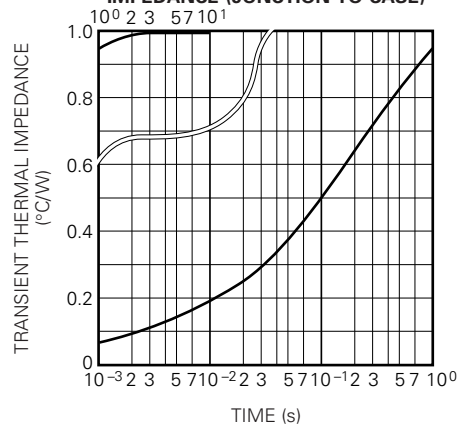

TM20RA-M,-H

MEDIUM POWER GENERAL USE  
INSULATED TYPE

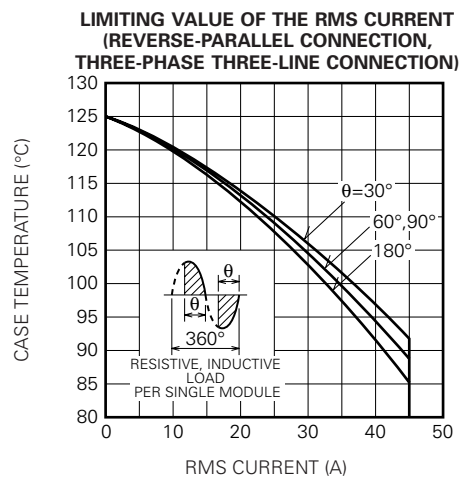
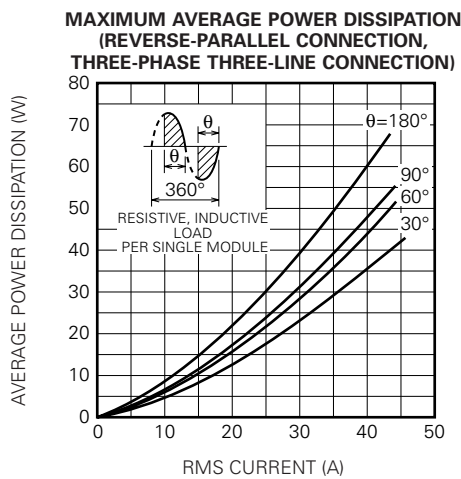
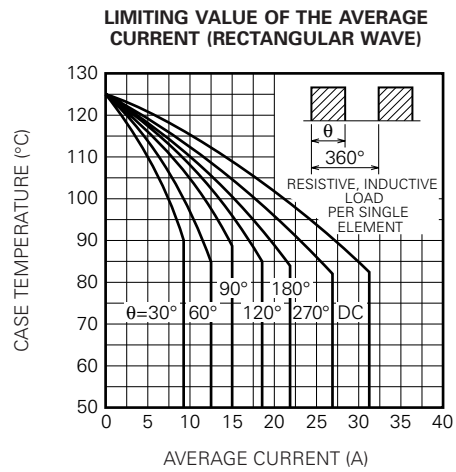
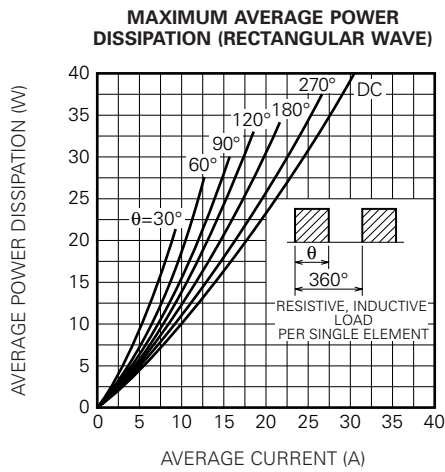
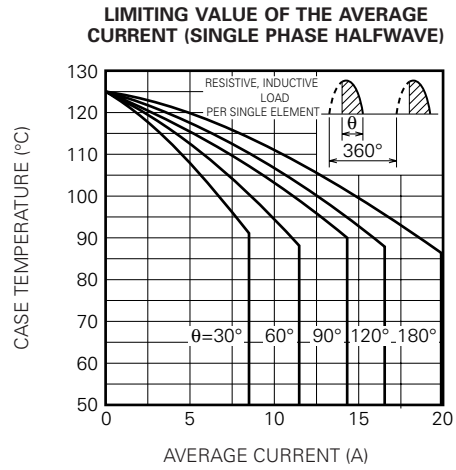
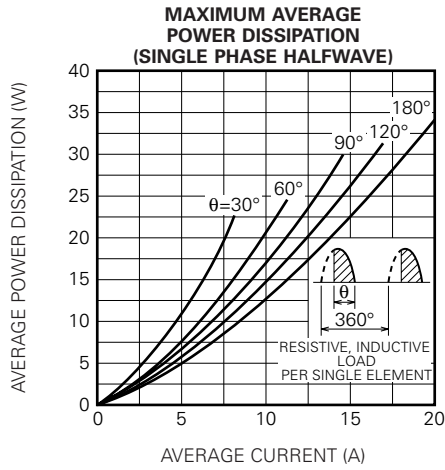

# TM20RA-M,-H

MEDIUM POWER GENERAL USE  
INSULATED TYPE

**MAXIMUM POWER DISSIPATION  
(SINGLE PHASE FULLWAVE RECTIFIED)**

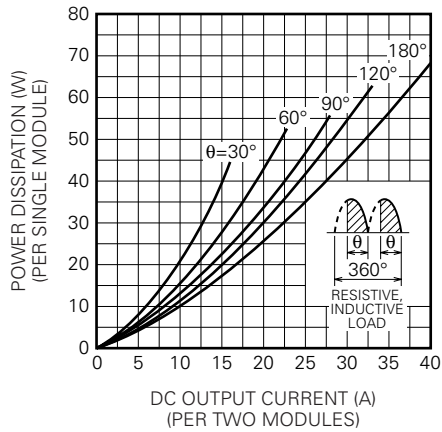

**LIMITING VALUE OF THE DC OUTPUT CURRENT  
(SINGLE PHASE FULLWAVE RECTIFIED)**

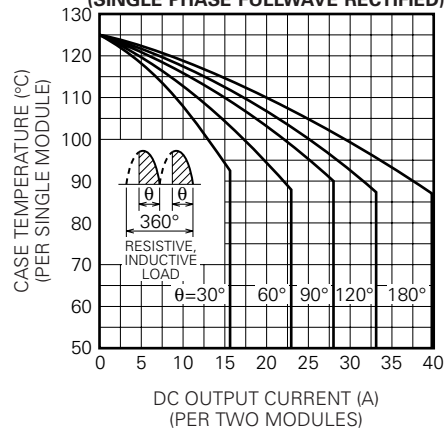

**MAXIMUM POWER DISSIPATION  
(THREE-PHASE FULLWAVE RECTIFIED)**

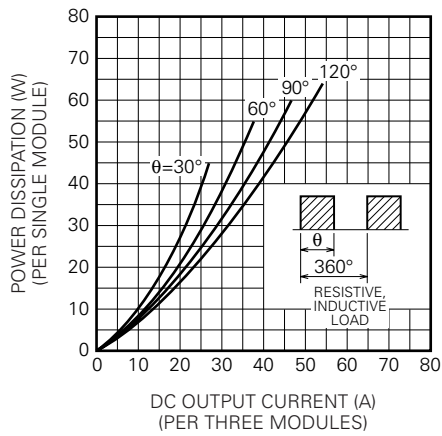

**LIMITING VALUE OF THE DC OUTPUT CURRENT  
(THREE-PHASE FULLWAVE RECTIFIED)**

