

DC/DC converter

Input 36-75 Vdc
Output up to 30A/100W

Key Features

- Industry standard Half-brick
58x61x8.5 mm (2.3x2.4x0.33 in)
- Low profile, max 8.5 mm (0.33 in)
- Design for environment in a cost efficient open-frame design
- High efficiency, typ. 93 % at 3.3 Vout half load
- 1500 VDC input to output isolation, meets isolation requirements equivalent to Basic Insulation according to IEC/EN/UL 60950
- More than 6 million hours predicted MTBF at 55° C ambient and 1 m/s (200 lfm) airflow

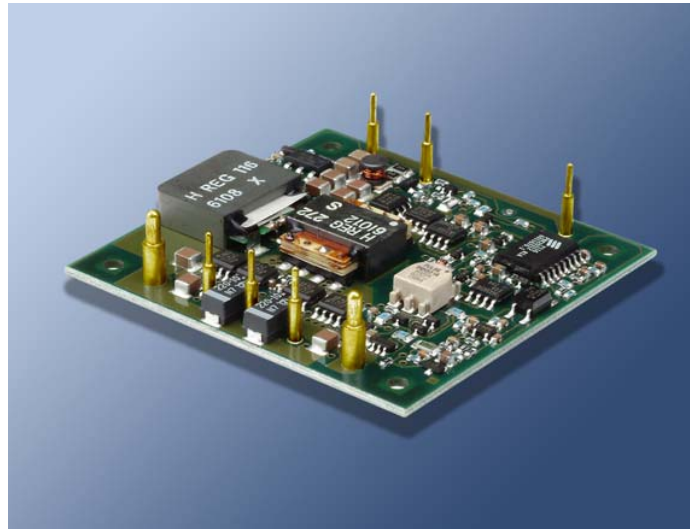

The PKJ 4000E series of high efficiency DC/DC converters are designed to provide high quality on-board power solutions in distributed power architectures used in Internetworking equipment in wireless and wired communications applications.

The PKJ 4000E series has industry standard half brick footprint and pin-out and is only 8.5 mm (0.33 in) high. This makes it extremely well suited for narrow board pitch applications with board spacing down to 15 mm (0.6 in). The PKJ 4000E series uses patented synchronous rectification technology and achieves an efficiency up to 89% at full load. Ericsson's PKJ 4000E series addresses the emerging telecom market

for applications in the multi-service network by specifying the input voltage range in accordance with ETSI specifications.

Included as standard features are output over-voltage protection, input under-voltage protection, over temperature protection, soft-start, output short circuit protection, remote sense, remote control, and output voltage adjust function.

These converters are designed to meet high reliability requirements and are manufactured in highly automated manufacturing lines and meet world-class quality levels. Ericsson Power Modules is an ISO 9001/14001 certified supplier.

Absolute Maximum Ratings

Characteristics		min	max	Unit
T_{Pcb}	Maximum Operating Pcb Temperature	-40	+125	°C
T_S	Storage temperature	-55	+125	°C
V_I	Input voltage	-0.5	+80	Vdc
V_{ISO}	Isolation voltage (input to output test voltage)		1500	Vdc
V_{tr}	Input voltage transient for 100 ms		100	Vdc
V_{RC}	Negative logic		75	Vdc
V_{RC}	Positive logic		6	Vdc
V_{adj}	Maximum input	-0.5	$2 \times V_{oi}$	Vdc

Note:

Stress in excess of Absolute Maximum Ratings may cause permanent damage. Absolute Maximum Ratings, sometimes referred to as no destruction limits, are normally tested with one parameter at a time exceeding the limits of Output data or Electrical Characteristics. If exposed to stress above these limits, function and performance may degrade in an unspecified manner.

Input $T_{Pcb} < T_{Pcb\ max}$ unless otherwise specified

Characteristics		Conditions	min	typ	max	Unit
V_I	Input voltage range ¹⁾		36		75	Vdc
V_{loff}	Turn-off input voltage	Ramping from higher voltage		32		Vdc
V_{lon}	Turn-on input voltage	Ramping from lower voltage		34		Vdc
C_I	Input capacitance			2		µF
I_{lac}	Reflected ripple current	5 Hz to 20 MHz		TBD		mA _{p-p}
P_{II}	Input idling power	$I_o = 0, V_I = 53\ V$		2		W
P_{RC}	Input standby power (turned off with RC)	$V_I = 53\ V, RC\ activated$		0.25		W

Environmental Characteristics

Characteristics			
Random Vibration	IEC 68-2-34 E _d	Frequency Spectral density Duration	10 ... 500 Hz 0.07 g ² /Hz 10 min each direction
Sinusoidal Vibration	IEC 68-2-6 F _c	Frequency Amplitude Acceleration Number of cycles	10 ... 500 Hz 0.75 mm 10 g 10 in each axis
Shock (half sinus)	IEC 68-2-27 E _a	Peak acceleration Duration	100 g 6 ms
Temperature change	IEC 68-2-14 N _a	Temperature Number of cycles	-40 ... +100 °C 300
Heat/Humidity	IEC 68-2-3 C _a	Temperature Humidity Duration	+85 °C 85 % RH 1000 hours
Solder heat stability	IEC 68-2-20 1A	Temperature, solder Duration	260 °C 10 ... 13 s
Resistance to cleaning solvents	IEC 68-2-45 XA Method 2	Water Isopropyl alcohol Glycol ether	+55 ± 5 °C +35 ± 5 °C +35 ± 5 °C
Cold (in operation)	IEC 68-2-1 A _d	Temperature Duration	-45 °C 2 h
Storage test	IEC 68-2-2 B _a	Temperature Duration	+125 °C 1000 h

Safety

The PKJ 4000 E series DC/DC converters are designed in accordance with safety standards IEC/EN/UL 60 950, *Safety of Information Technology Equipment*. The PKJ 4000 E series DC/DC converters are UL 60 950 recognized and certified in accordance with EN 60 950.

The DC/DC converter should be installed in the end-use equipment, in accordance with the requirements of the ultimate application. The input source must be isolated by minimum Basic insulation from the primary circuit in accordance with IEC/EN/UL 60 950. If the input voltage to the DC/DC converter is 75 V dc or less, then the output remains SELV (Safety Extra Low Voltage) under normal and abnormal operating conditions.

Single fault testing in the input power supply circuit should be performed with the DC/DC converter connected to demonstrate that the input voltage does not exceed 75 V dc. If the input power source circuit is a DC power system, the source may be treated as a TNV2 circuit and testing has demonstrated compliance with SELV limits and isolation requirements equivalent to Basic insulation in accordance with IEC/EN/UL 60 950.

It is recommended that a fast blow fuse with a rating of 10A be used at the input of each DC/DC converter. The PKJ series DC/DC converters are approved for a maximum fuse rating of 15A. If a fault occurs in the converter that imposes a short circuit on the input source, this fuse will provide the following functions:

- Isolate the faulty DC/DC converter from the input power source not to affect the operation of other parts of the system.
- Protect the distribution wiring from excessive current and power loss thus preventing hazardous overheating.

The galvanic isolation is verified in an electric strength test. The test voltage (V_{ISO}) between input and output is 1500 Vdc for 60 seconds. Leakage current is less than 1µA at nominal input voltage.

The flammability rating for all construction parts of the DC/DC converter meets UL 94V-0.

Mechanical Data

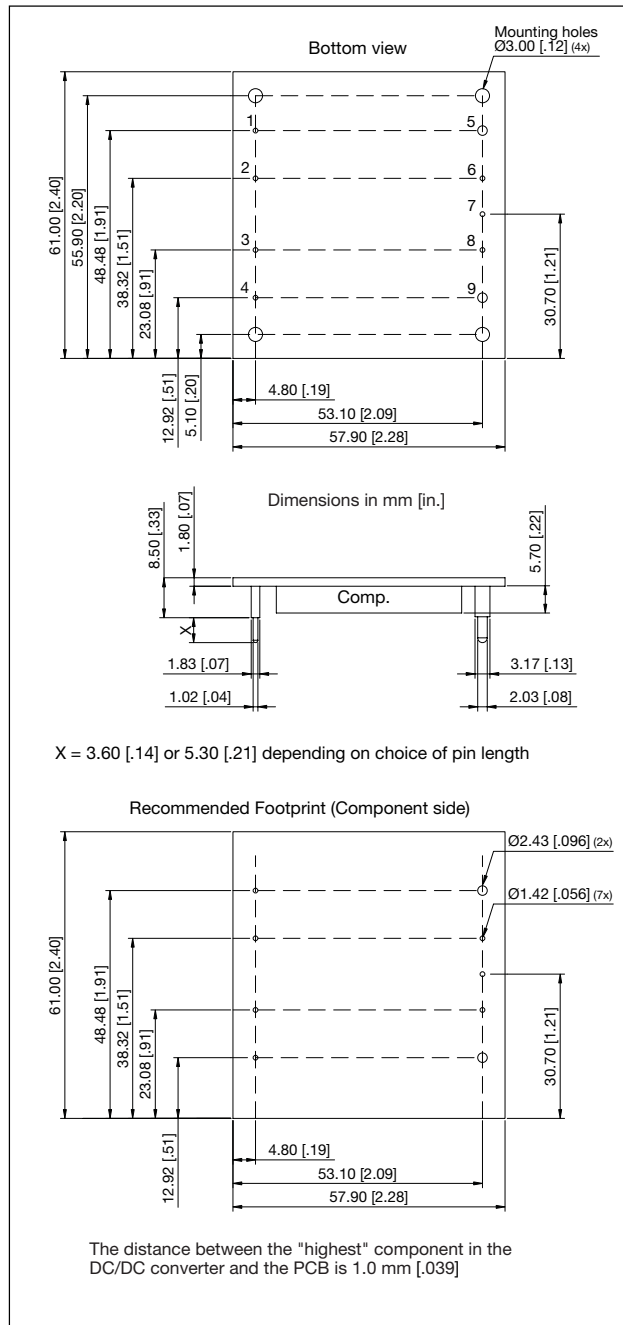

Connections

Pin	Designation	Function
1	- In	Negative Input
2		No pin
3	RC	Remote Control
4	+ In	Positive Input
5	- Out	Negative Output
6	- Sen	Negative Sense
7	V _{adj}	Output voltage adjust
8	+ Sen	Positive Sense
9	+ Out	Positive Output

For more information about the functions see Operating Information

Fundamental Circuit Diagram

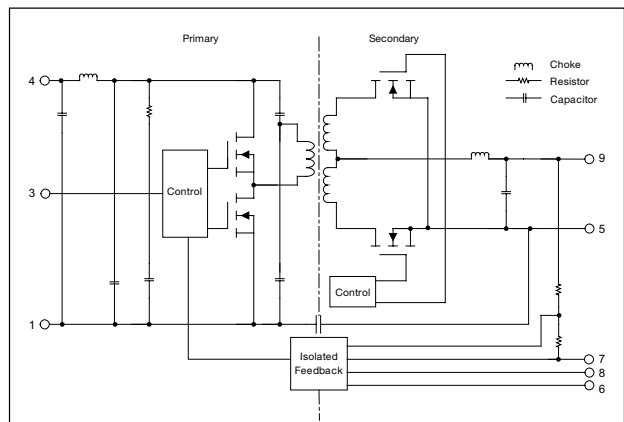

Weight

PKJ 4810E PI 35 g

Pins

Material: Brass Alloy

Plating: 0.1 μm Gold over Nickel

PKJ 4719E PI Output

$T_{Pcb} = -40...+125^{\circ}\text{C}$, $V_I = 36 \dots 75\text{V}$, sense pins connected to output pins unless otherwise specified.

Characteristics		Conditions	Output			Unit
			min	typ	max	
V_{O_i}	Output voltage initial setting and accuracy	$T_{Pcb} = +25^{\circ}\text{C}$, $V_I = 53\text{V}$, $I_O = I_{Omax}$	2.475	2.50	2.525	V
	Output adjust range	$I_O = I_{Omax}$	2.00		2.75	V
V_O	Output voltage tolerance band	$I_O = 0.1...1 \times I_{Omax}$	2.44		2.56	V
	Idling voltage	$I_O = 0$	2.44		2.56	V
	Line regulation	$I_O = I_{Omax}$			5	mV
	Load regulation	$V_I = 53\text{V}$, $I_O = 0.01...1 \times I_{Omax}$			5	mV
V_{tr}	Load transient voltage deviation	$I_O = 0.1...1 \times I_{Omax}$, $V_I = 53\text{V}$ Load step = $0.5 \times I_{Omax}$ di/dt = $1\text{A}/\mu\text{s}$		± 200		mV
t_{tr}	Load transient recovery time	$I_O = 0.1...1 \times I_{Omax}$, $V_I = 53\text{V}$ loadstep = $0.5 \times I_{Omax}$		100		μs
t_r	Ramp-up time	$I_O = 0.1...0.9 \times V_O$		15	30	ms
t_s	Start-up time	From V_I connected to $V_O = 0.9 \times V_{O_i}$		20	40	ms
I_O	Output current		0		30	A
P_{Omax}	Max output power	At $V_O = V_{Onom}$	75			W
I_{lim}	Current limit threshold	$T_{Pcb} < T_{Pcbmax}$		32		A
I_{sc}	Short circuit current	$T_{Pcb} = 25^{\circ}\text{C}$		40		A
V_{Oac}	Output ripple & noise	$I_O = I_{Omax}$, $f < 5\text{MHz}$		50	150	mV _{p-p}
SVR	Supply voltage rejection (ac)	$f = 100\text{Hz}$ sinewave, 1 V _{p-p} , $V_I = 53\text{V}$		70		dB
OVP	Over voltage protection	$V_I = 53\text{V}$	3.0		4.0	V

Miscellaneous

Characteristics		Conditions	min	typ	max	Unit
η	Efficiency - 50% load	$T_{Pcb} = +25^{\circ}\text{C}$, $V_I = 53\text{V}$, $I_O = 0.5 \times I_{Omax}$		90		%
η	Efficiency - 100% load	$T_{Pcb} = +25^{\circ}\text{C}$, $V_I = 53\text{V}$, $I_O = I_{Omax}$	85.5	86.5		%
P_d	Power Dissipation	$T_{Pcb} = +25^{\circ}\text{C}$, $V_I = 53\text{V}$, $I_O = I_{Omax}$		12		W
f_s	Switching frequency	$I_O = 0 \dots 1.0 \times I_{Omax}$		140		kHz
I_{Imax}	Maximum input current	$1.1 \times V_{O_i} \times I_{Omax} / \eta / V_{Imin}$		2.6		A

PKJ 4719E PI Typical Characteristics

Efficiency

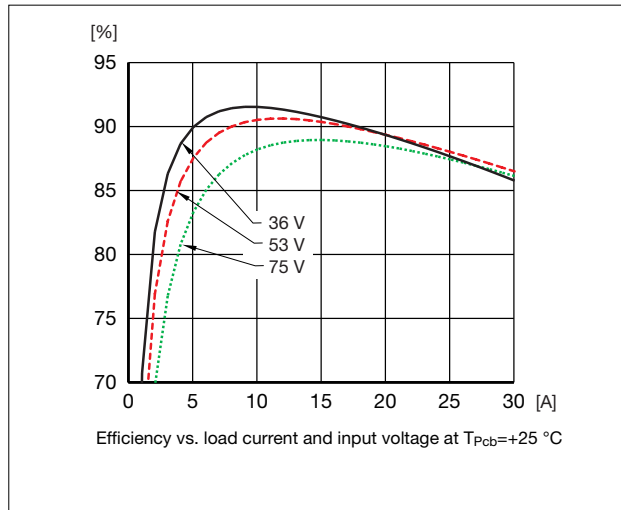

Output Current Derating

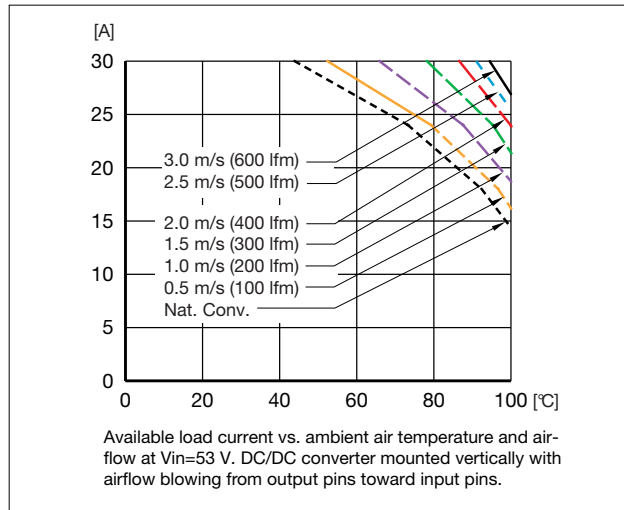

Output Characteristic

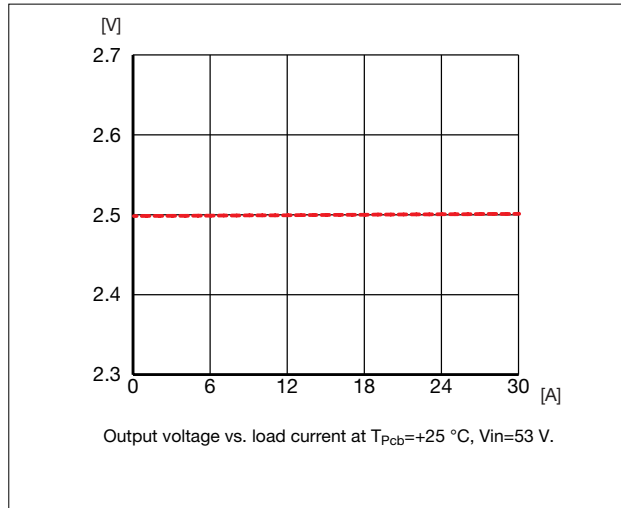

Power Dissipation

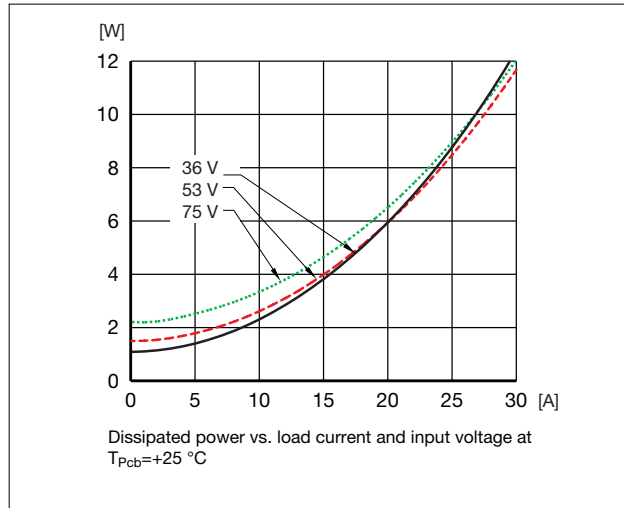

Start-Up

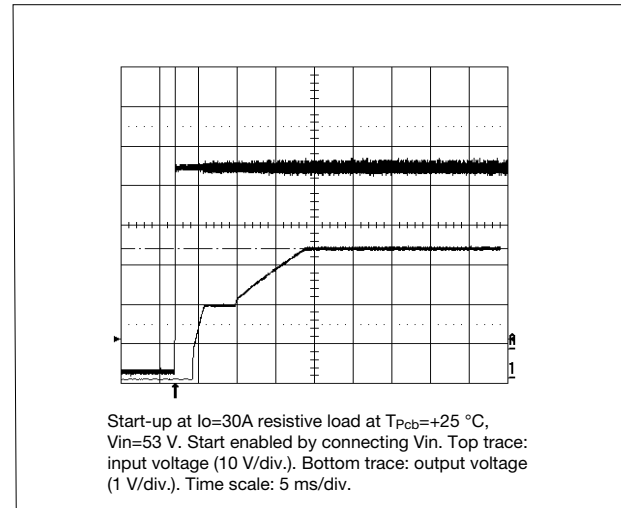

Turn-Off

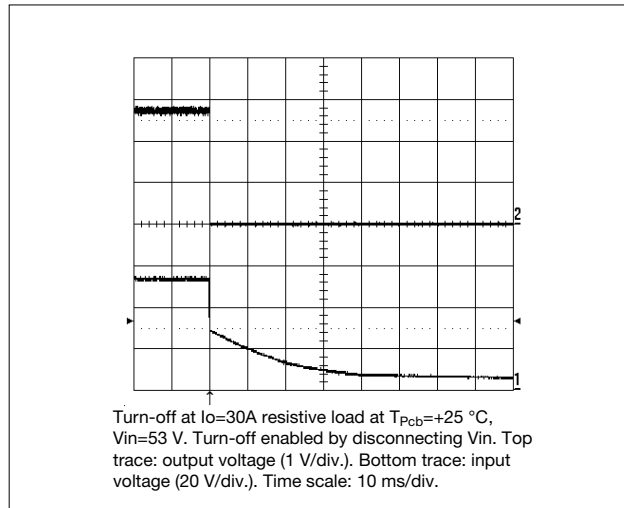

PKJ 4719E PI Typical Characteristics

Output Ripple

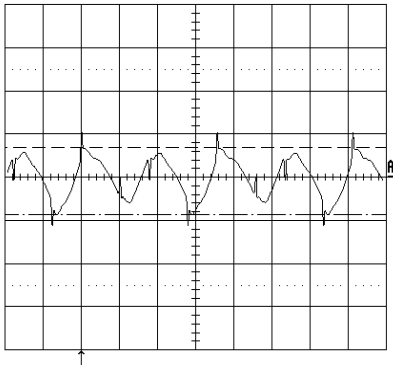

Output voltage ripple (50mV/div.) at $T_{Pcb}=+25\text{ }^{\circ}\text{C}$, $V_{in}=53\text{ V}$, $I_o=30\text{A}$ resistive load. Band width=4MHz. Time scale: $2\mu\text{s} / \text{div}$.

Transient

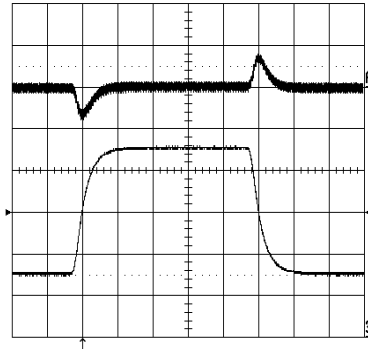

Output voltage response to load current step-change (7.5-22.5-7.5 A) at $T_{Pcb}=+25\text{ }^{\circ}\text{C}$, $V_{in}=53\text{ V}$. Top trace: output voltage (200mV/div.). Bottom trace: load current (5 A/div.) Time scale: 0.1 ms/div.

Output Voltage Adjust

The resistor value for an adjusted output voltage is calculated by using the following equations:

Output Voltage Adjust Upwards, Increase:

$$R_{adj} = [2.5(100+\Delta\%)/1.225\Delta\% - (100+2\Delta\%)/\Delta\%] \text{ k}\Omega$$

Output Voltage Adjust Downwards, Decrease:

$$R_{adj} = [(100/\Delta\% - 2)] \text{ k}\Omega$$

Eg Increase 4% $\Rightarrow V_{out} = 2.600\text{ V}_{dc}$

$$2.5(100+4)/1.225 \times 4 - 100 + 2 \times 4/4 = 26.06 \text{ k}\Omega$$

Eg Decrease 2% $\Rightarrow V_{out} = 2.450\text{ V}_{dc}$

$$100/2 - 2 = 48.0 \text{ k}\Omega$$

Output Voltage Adjust

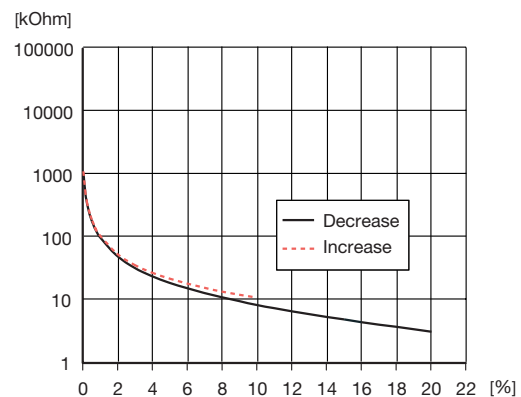

Output voltage adjust resistor value vs. percentage change in output voltage.

PKJ 4810E PI Output

$T_{Pcb} = -40...+125^{\circ}\text{C}$, $V_I = 36 \dots 75\text{V}$, sense pins connected to output pins unless otherwise specified.

Characteristics		Conditions	Output			Unit
			min	typ	max	
V_{O_i}	Output voltage initial setting and accuracy	$T_{Pcb} = +25^{\circ}\text{C}$, $V_I = 53\text{V}$, $I_O = I_{Omax}$	3.26	3.30	3.34	V
	Output adjust range	$I_O = I_{Omax}$	2.64		3.63	V
V_O	Output voltage tolerance band	$I_O = 0.1...1 \times I_{Omax}$	3.24		3.36	V
	Idling voltage	$I_O = 0$	3.24		3.36	V
	Line regulation	$I_O = I_{Omax}$			5	mV
	Load regulation	$V_I = 53\text{V}$, $I_O = 0.01...1 \times I_{Omax}$			5	mV
V_{tr}	Load transient voltage deviation	$I_O = 0.1...1 \times I_{Omax}$, $V_I = 53\text{V}$ Load step = $0.5 \times I_{Omax}$ $di/dt = 1\text{A}/\mu\text{s}$		± 300		mV
t_{tr}	Load transient recovery time	$I_O = 0.1...1 \times I_{Omax}$, $V_I = 53\text{V}$ loadstep = $0.5 \times I_{Omax}$		100		μs
t_r	Ramp-up time	$I_O = 0.1...0.9 \times V_O$		15	30	ms
t_s	Start-up time	From V_I connected to $V_O = 0.9 \times V_{O_i}$		20	40	ms
I_O	Output current		0		25	A
P_{Omax}	Max output power	At $V_O = V_{Onom}$	82.5			W
I_{lim}	Current limit threshold	$T_{Pcb} < T_{Pcbmax}$		29		A
I_{sc}	Short circuit current	$T_{Pcb} = 25^{\circ}\text{C}$		33		A
V_{Oac}	Output ripple & noise	$I_O = I_{Omax}$, $f < 5\text{MHz}$		60	100	mV_{p-p}
SVR	Supply voltage rejection (ac)	$f = 100\text{Hz}$ sinewave, 1V_{p-p} , $V_I = 53\text{V}$		80		dB
OVP	Over voltage protection	$V_I = 53\text{V}$	3.9	4.4	5.0	V

Miscellaneous

Characteristics		Conditions	min	typ	max	Unit
η	Efficiency - 50% load	$T_{Pcb} = +25^{\circ}\text{C}$, $V_I = 53\text{V}$, $I_O = 0.5 \times I_{Omax}$		93		%
η	Efficiency - 100% load	$T_{Pcb} = +25^{\circ}\text{C}$, $V_I = 53\text{V}$, $I_O = I_{Omax}$	87	89		%
P_d	Power Dissipation	$T_{Pcb} = +25^{\circ}\text{C}$, $V_I = 53\text{V}$, $I_O = I_{Omax}$		10		W
f_s	Switching frequency	$I_O = 0 \dots 1.0 \times I_{Omax}$		140		kHz
I_{Imax}	Maximum input current	$1.1 \times V_{O_i} \times I_{Omax} / \eta / V_{Imin}$		2.8		A

PKJ 4810E PI Typical Characteristics

Efficiency

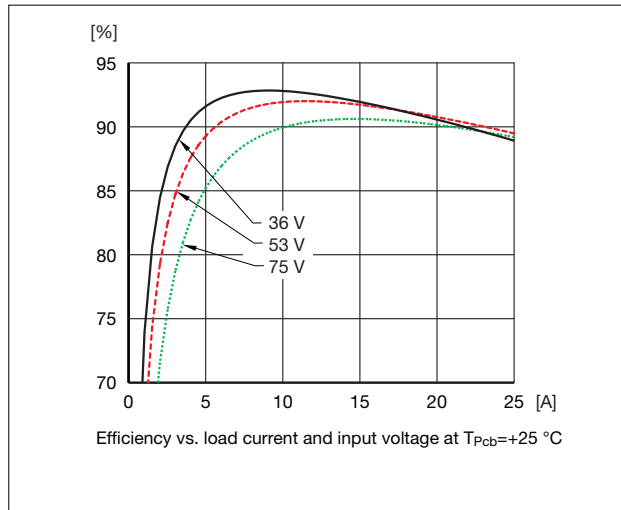

Output Current Derating

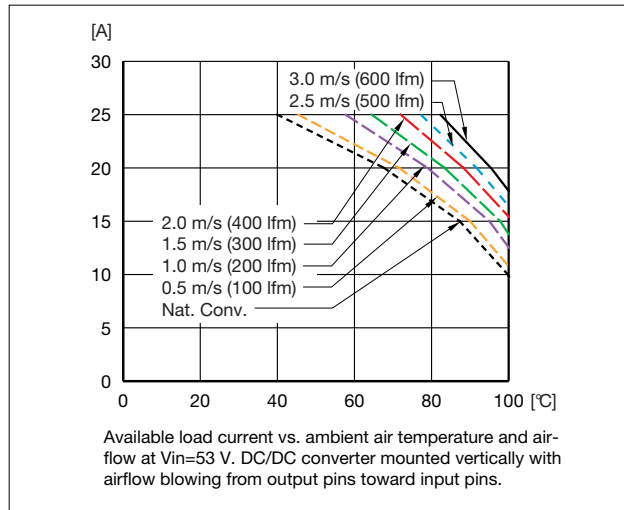

Output Characteristic

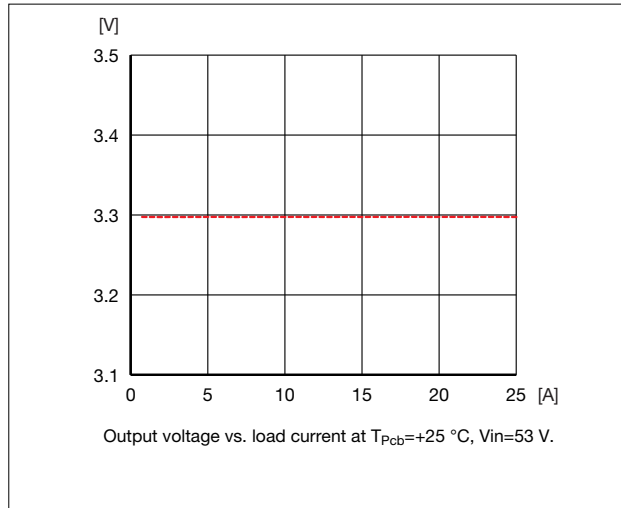

Power Dissipation

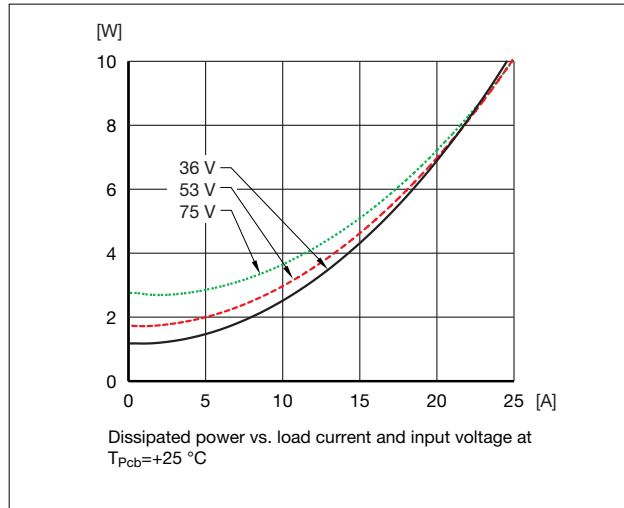

Start-Up

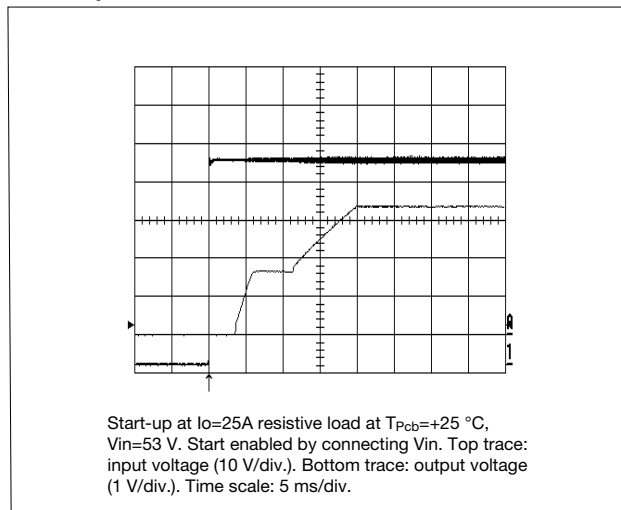

Turn-Off

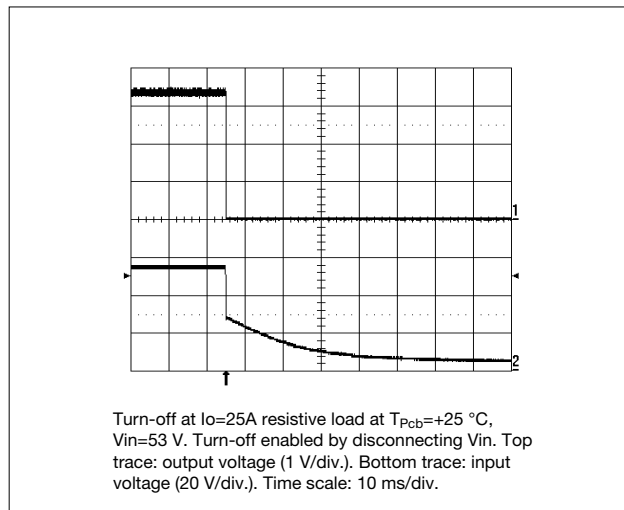

PKJ 4810E PI Typical Characteristics

Output Ripple

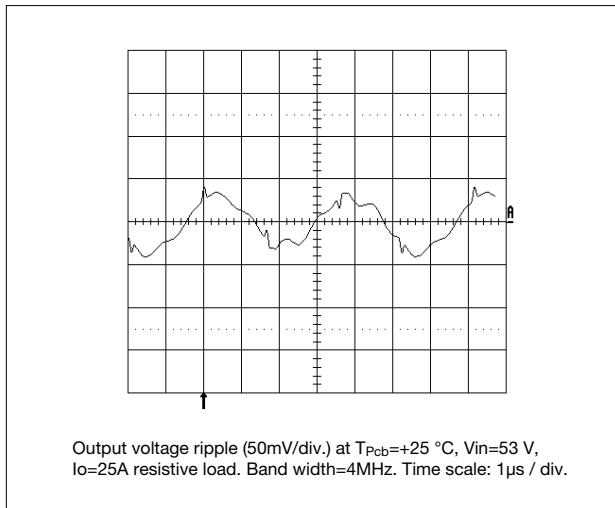

Transient

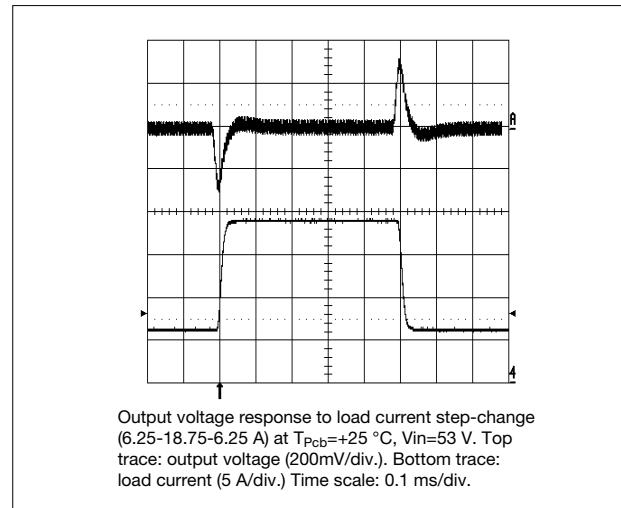

Output Voltage Adjust

The resistor value for an adjusted output voltage is calculated by using the following equations:

Output Voltage Adjust Upwards, Increase:

$$R_{adj} = [3.3(100+\Delta\%)/1.225\Delta\% - (100+2\Delta\%)/\Delta\%] \text{ k}\Omega$$

Output Voltage Adjust Downwards, Decrease:

$$R_{adj} = [(100/\Delta\% - 2)] \text{ k}\Omega$$

Eg Increase 4% $\Rightarrow V_{out} = 3.432 V_{dc}$

$$3.3 (100+4)/1.225 \times 4 - 100 + 2 \times 4/4 = 43.04 \text{ k}\Omega$$

Eg Decrease 2% $\Rightarrow V_{out} = 3.234 V_{dc}$

$$100/2 - 2 = 48.00 \text{ k}\Omega$$

Output Voltage Adjust

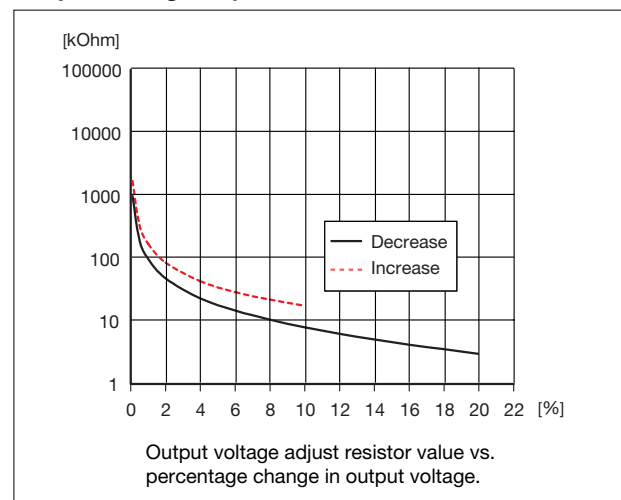

PKJ 4111 E PI Output

$T_{Pcb} = -40...+125^{\circ}C$, $V_I = 36 ...75V$, sense pins connected to output pins unless otherwise specified.

Characteristics		Conditions	Output			Unit
			min	typ	max	
V_{O_i}	Output voltage initial setting and accuracy	$T_{Pcb} = +25^{\circ}C$, $V_I = 53 V$, $I_O = I_{Omax}$	4.96	5.00	5.04	V
	Output adjust range	$I_O = I_{Omax}$	4.00		5.50	V
V_O	Output voltage tolerance band	$I_O = 0.1...1 \times I_{Omax}$	4.94		5.06	V
	Idling voltage	$I_O = 0$	4.94		5.06	V
	Line regulation	$I_O = I_{Omax}$			5	mV
	Load regulation	$V_I = 53 V$, $I_O = 0.01...1 \times I_{Omax}$			5	mV
V_{tr}	Load transient voltage deviation	$I_O = 0.1...1 \times I_{Omax}$, $V_I = 53 V$ Load step = $0.5 \times I_{Omax}$ di/dt = $1A/\mu s$		± 300		mV
t_{tr}	Load transient recovery time	$I_O = 0.1...1 \times I_{Omax}$, $V_I = 53 V$ loadstep = $0.5 \times I_{Omax}$		100		μs
t_r	Ramp-up time	$I_O = 0.1...0.9 \times V_O$		15	30	ms
t_s	Start-up time	From V_I connected to $V_O = 0.9 \times V_{O_i}$		20	40	ms
I_O	Output current		0		20	A
P_{Omax}	Max output power	At $V_O = V_{Onom}$	100			W
I_{lim}	Current limit threshold	$T_{Pcb} < T_{Pcbmax}$		23		A
I_{sc}	Short circuit current	$T_{Pcb} = 25^{\circ}C$		27		A
V_{Oac}	Output ripple & noise	$I_O = I_{Omax}$, $f < 5 MHz$		50	100	mV _{p-p}
SVR	Supply voltage rejection (ac)	$f = 100 Hz$ sinewave, 1 V _{p-p} , $V_I = 53 V$		70		dB
OVP	Over voltage protection	$V_I = 53 V$	6.0		7.5	V

Miscellaneous

Characteristics		Conditions	min	typ	max	Unit
η	Efficiency - 50% load	$T_{Pcb} = +25^{\circ}C$, $V_I = 53 V$, $I_O = 0.5 \times I_{Omax}$		92		%
η	Efficiency - 100% load	$T_{Pcb} = +25^{\circ}C$, $V_I = 53 V$, $I_O = I_{Omax}$	87	89		%
P_d	Power Dissipation	$T_{Pcb} = +25^{\circ}C$, $V_I = 53 V$, $I_O = I_{Omax}$		12		W
f_s	Switching frequency	$I_O = 0 ... 1.0 \times I_{Omax}$		140		kHz
I_{Imax}	Maximum input current	$1.1 \times V_{O_i} \times I_{Omax} / \eta / V_{Imin}$		3.4		A

PKJ 4111E PI Typical Characteristics

Efficiency

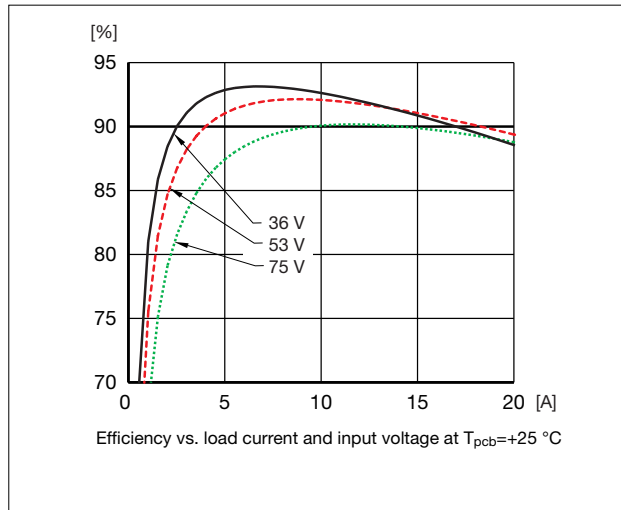

Output Current Derating

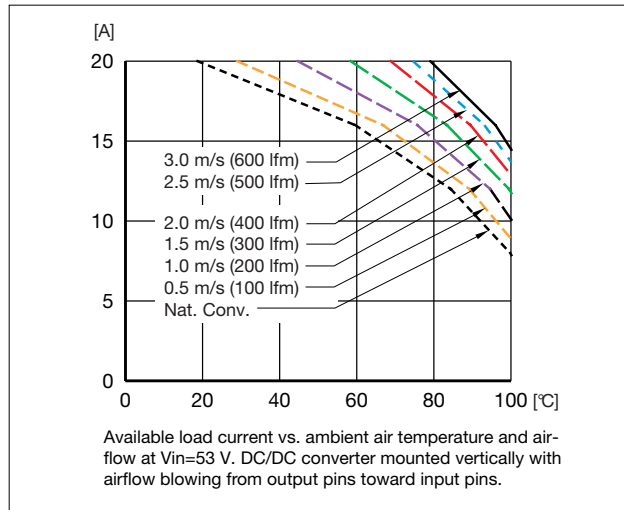

Output Characteristic

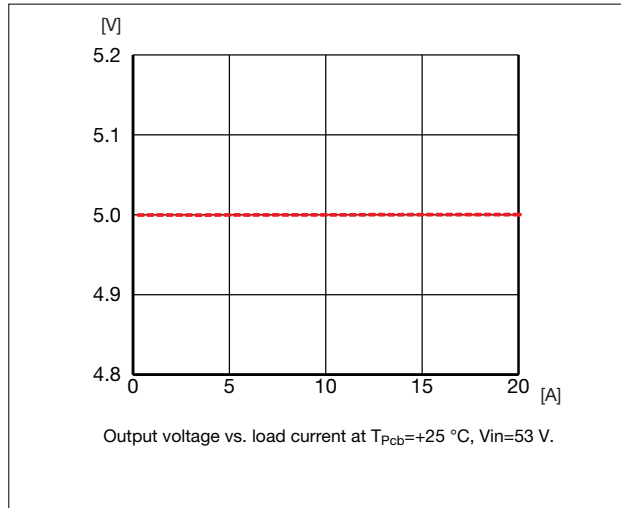

Power Dissipation

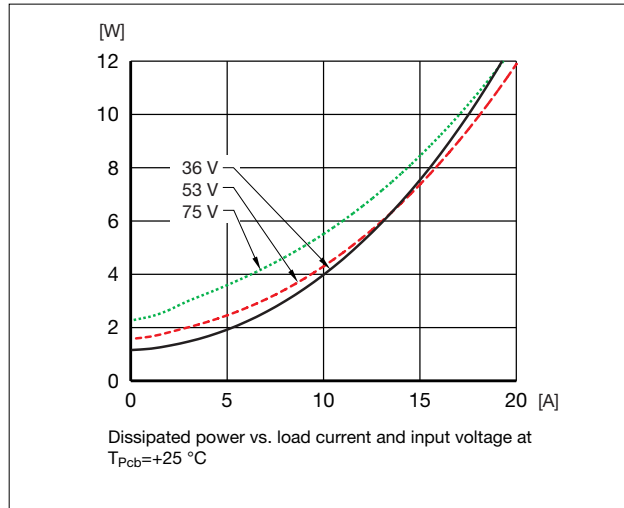

Start-Up

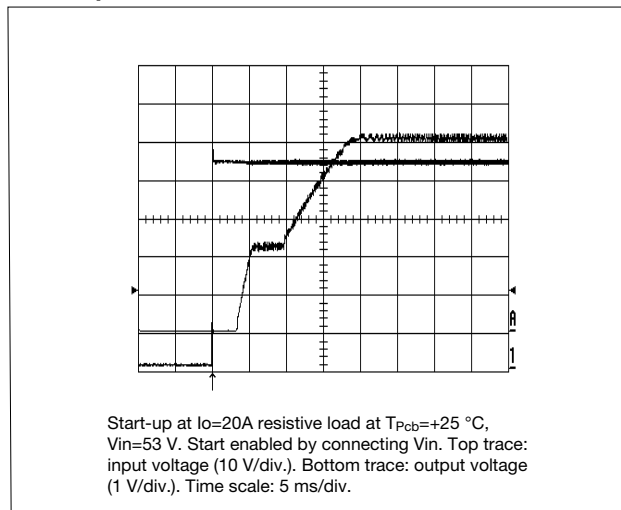

Turn-Off

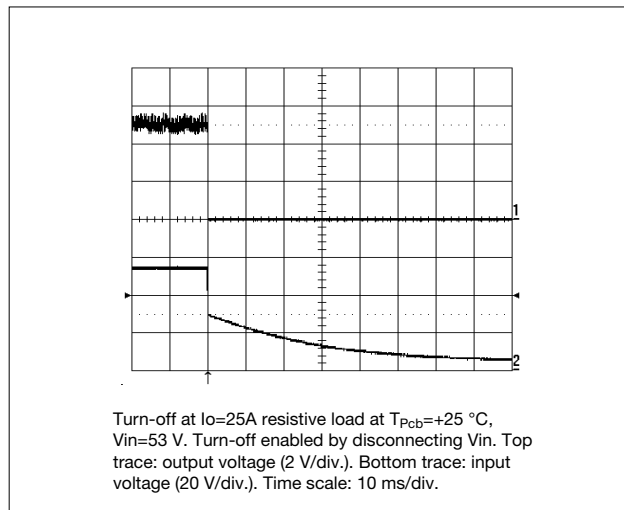

PKJ 4111E PI Typical Characteristics

Output Ripple

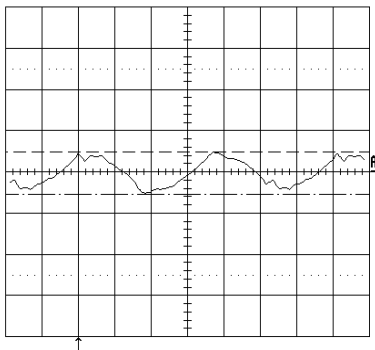

Output voltage ripple (50mV/div.) at $T_{Pcb}=+25\text{ }^{\circ}\text{C}$, $V_{in}=53\text{ V}$, $I_o=20\text{A}$ resistive load. Band width=4MHz. Time scale: $1\mu\text{s} / \text{div}$.

Transient

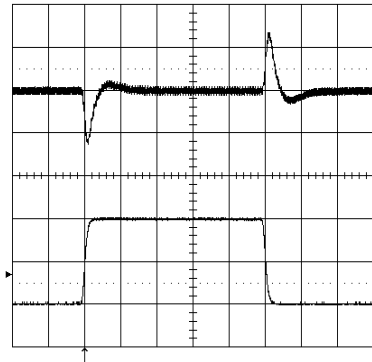

Output voltage response to load current step-change (5.0-15-5.0 A) at $T_{Pcb}=+25\text{ }^{\circ}\text{C}$, $V_{in}=53\text{ V}$. Top trace: output voltage (200mV/div.). Bottom trace: load current (5 A/div.) Time scale: 0.1 ms/div.

Output Voltage Adjust

The resistor value for an adjusted output voltage is calculated by using the following equations:

Output Voltage Adjust Upwards, Increase:

$$R_{adj} = [5.0(100+\Delta\%) / 1.225\Delta\% - (100+2\Delta\%) / \Delta\%] \text{ k}\Omega$$

Output Voltage Adjust Downwards, Decrease:

$$R_{adj} = [(100 / \Delta\% - 2)] \text{ k}\Omega$$

Eg Increase 4% $\Rightarrow V_{out} = 5.200\text{ V}_{dc}$

$$5.0 (100+4) / 1.225 \times 4 - 100 + 2 \times 4 / 4 = 79.12 \text{ k}\Omega$$

Eg Decrease 2% $\Rightarrow V_{out} = 4.900\text{ V}_{dc}$

$$100 / 2 - 2 = 48.00 \text{ k}\Omega$$

Output Voltage Adjust

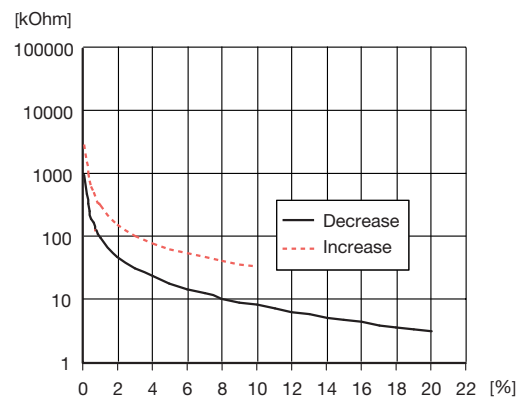

Output voltage adjust resistor value vs. percentage change in output voltage.

EMC Specification

The conducted EMI measurement was performed using a module placed directly on the test bench.
 The fundamental switching frequency is 140kHz for PKJ 4810E PI @ $V_I = 53V$, $I_O = (0.1...1.0) \times I_{Omax}$.

Conducted EMI Input terminal value (typ)

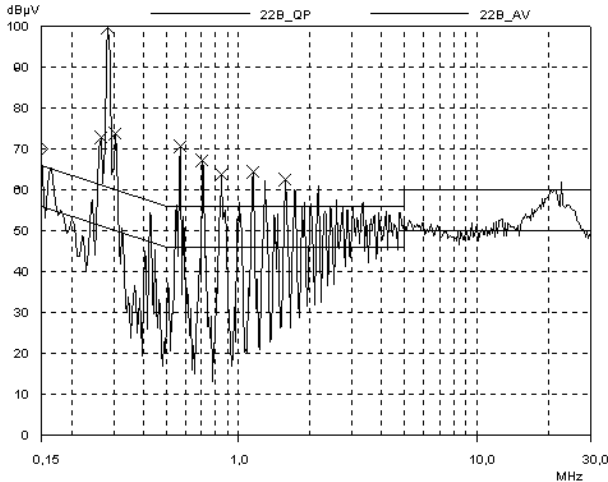

PKJ 4810E PI without filter.

External filter (class B)

Required external input filter in order to meet class B in EN 55022, CISPR 22 and FCC part 15J.

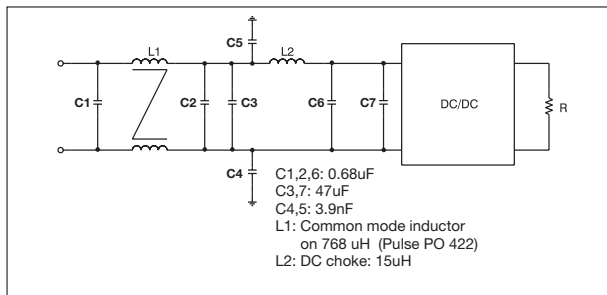

The capacitors are ceramic type. Low ESR is critical for achieving these results.

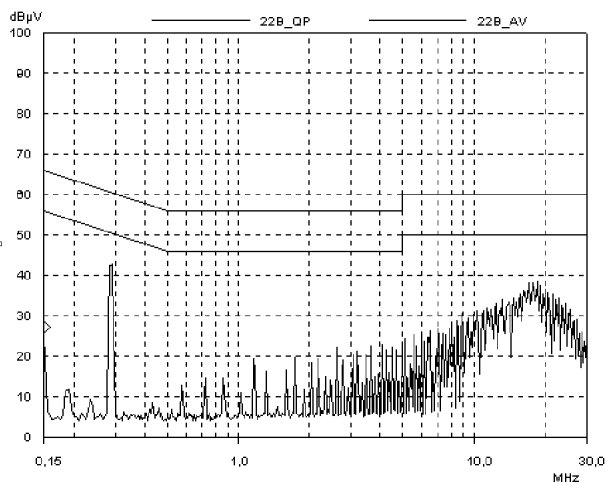

PKJ 4810E PI with filter.

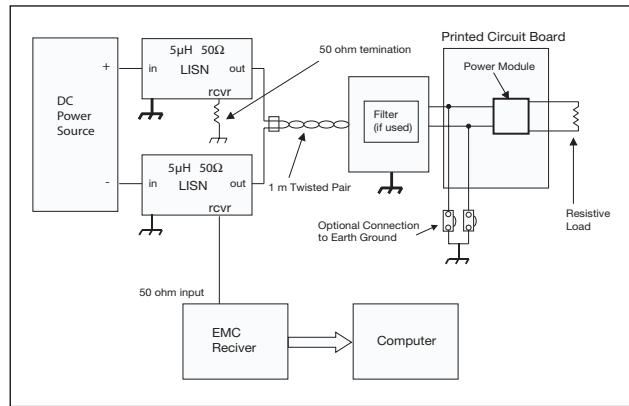

Test set-up.

Layout Recommendation

The radiated EMI performance of the DC/DC converter will be optimised by including a ground plane in the PCB area under the DC/DC converter. This approach will return switching noise to ground as directly as possible, with improvements to both emissions and susceptibility. If one ground trace is used, it should be connected to the input return. Alternatively, two ground traces may be used, with the trace under the input side of the DC/DC converter connected to the input return and the trace under the output side of the DC/DC converter connected to the output return. Make sure to use appropriate safety isolation spacing between these two return traces. The use of two traces as described will provide the capability of routing the input noise and output noise back to their respective returns.

Operating Information

Input Voltage

The input voltage range 36...75Vdc meets the requirements of the European Telecom Standard ETS 300 132-2 for normal input voltage range in -48V and -60V DC systems, -40.5...-57.0V and -50.0...-72V respectively. At input voltages exceeding 75V, the power loss will be higher than at normal input voltage and T_{Pcb} must be limited to absolute max +125°C. The absolute maximum continuous input voltage is 80Vdc.

Turn-Off Input Voltage

The PKJ 4000E Series DC/DC converters monitor the input voltage and will turn on and turn off at predetermined levels. The minimum hysteresis between turn on and turn off input voltage is 1V where the turn on input voltage is the highest.

Remote Control (RC)

The PKJ 4000E Series DC/DC converters have remote control function referenced to the primary side (minus input), with negative and positive logic options available. The RC function is CMOS open drain compatible. Maximum sink current is 1mA. When the RC pin is left open, the voltage generated on the RC pin by the DC/DC converter is 3.5-6.0V. The maximum allowable leakage current of the switch is 50µA.

The standard converter is provided with “negative logic” remote control and will be off until the RC pin is connected to the minus input. To turn on the converter the voltage between RC pin and minus input should be less than 1V. To turn off the converter the RC pin should be left open, or connected to a voltage higher than 4V referenced to minus input. In situations where it is desired to have the converter power up automatically without the need for control signals or a switch, the RC pin can be wired directly to the -Input circuit on the application board.

The second option is “positive logic” remote control, which can be ordered by adding the suffix “P” to the end of the part number. The converter will turn on if the input voltage is applied with the RC pin open. Turn off is achieved by connecting the RC pin to the minus input. To ensure safe turn off the voltage difference between minus input pin and the RC pin shall be less than 1V. The converter will restart when this connection is opened.

Remote Sense

All PKJ 4000E Series DC/DC converters have remote sense that can be used to compensate for moderate amounts of resistance in the distribution system and allow for voltage regulation at the load or other selected point. The remote sense lines will carry very little current and do not need a large cross sectional area. However, the sense lines on the PCB should be located close to a ground trace or ground plane. In a discrete wiring situation, the use of twisted pair wires or other technique to reduce noise susceptibility is highly recommended. The remote sense circuitry will compensate for up to 10% voltage drop between the sense voltage and the voltage at the output pins. The output voltage and the remote sense voltage offset must be less than the minimum over voltage trip point. If the remote sense is not needed the -Sense should be connected to -Out and +Sense should be connected to +Out.

Output Voltage Adjust (V_{adj})

All PKJ 4000E Series DC/DC converters have an Output Voltage adjust pin (V_{adj}). This pin can be used to adjust the output voltage above or below Output voltage initial setting. When increasing the output voltage, the voltage at the output pins (including any remote sense offset) must be kept below the overvoltage trip point, to prevent the converter from shut down. Also note that at increased output voltages the maximum power rating of the converter remains the same, and the output current capability will decrease correspondingly. To decrease the output voltage the resistor should be connected between V_{adj} pin and -Sense pin. To increase the voltage the resistor should be connected between V_{adj} pin and +Sense pin. The resistor value of the Output voltage adjust function is according to information given under the output section.

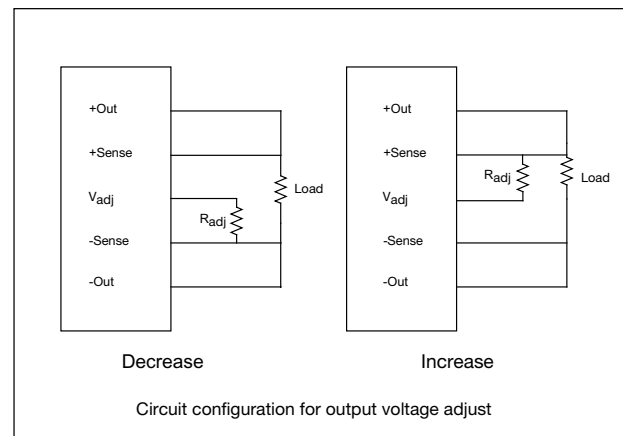

Operating Information

Current Limit Protection

The PKJ 4000E Series DC/DC converters include current limiting circuitry that allows them to withstand continuous overloads or short circuit conditions on the output. The output voltage will decrease towards zero for output currents in excess of max output current (I_{omax}).

The converter will resume normal operation after removal of the overload. The load distribution system should be designed to carry the maximum output short circuit current specified.

Over Voltage Protection (OVP)

The PKJ 4000E Series DC/DC converters have latching output overvoltage protection. In the event of an overvoltage condition, the converter will shut down immediately. The converter can be restarted by cycling the input voltage or using the remote control function.

Over Temperature Protection (OTP)

The PKJ 4000E Series DC/DC converters are protected from thermal overload by an internal over temperature shutdown circuit. When the PCB temperature (centre of PCB) exceeds 135 °C the converter will shut down immediately (latching). The converter can be restarted by cycling the input voltage or using the remote control function.

Input And Output Impedance

The impedance of both the power source and the load will interact with the impedance of the DC/DC converter. It is most important to have a ratio between L and C as low as possible, i.e. a low characteristic impedance, both at the input and output, as the converters have a low energy storage capability. The PKJ 4000E Series DC/DC converters have been designed to be completely stable without the need for external capacitors on the input or the output circuits. The performance in some applications can be enhanced by addition of external capacitance as described under maximum capacitive load. If the distribution of the input voltage source to the converter contains significant inductance, the addition of a 100µF capacitor across the input of the converter will help insure stability. This capacitor is not required when powering the DC/DC converter from a low impedance source with short, low inductance, input power leads.

Maximum Capacitive Load

When powering loads with significant dynamic current requirements, the voltage regulation at the load can be improved by addition of decoupling capacitance at the load. The most affective technique is to locate low ESR ceramic capacitors as close to the load as possible, using several capacitors to lower the effective ESR. These ceramic capacitors will handle short duration high-frequency components of dynamic load changes. In addition, higher values of electrolytic capacitors should be used to handle the mid-frequency components. It is equally important to use good design practise when configuring the DC distribution system.

Low resistance and low inductance PCB (printed circuit board) layouts and cabling should be used. Remember that when using remote sensing, all resistance, inductance and capacitance of the distribution system is within the feedback loop of the converter. This can affect on the converters compensation and the resulting stability and dynamic response performance. As a "rule of thumb", 100µF/A of output current can be used without any additional analysis. For example with a 25A converter, values of decoupling capacitance up to 2500 µF can be used without regard to stability. With larger values of capacitance, the load transient recovery time can exceed the specified value. As much of the capacitance as possible should be outside the remote sensing loop and close to the load. The absolute maximum value of output capacitance is 10 000 µF. For values larger than this, please contact your local Ericsson Power Modules representative.

Parallel Operation

The PKJ 4000E Series DC/DC converters can be paralleled for redundancy if external o-ring diodes are used in series with the outputs. It is not recommended to parallel the PKJ 4000E Series DC/DC converters for increased power without using external current sharing circuits.

Thermal Consideration

General

The PKJ 4000E Series DC/DC converters are designed to operate in a variety of thermal environments, however sufficient cooling should be provided to help ensure reliable operation. Heat is removed by conduction, convection and radiation to the surrounding environment. Increased airflow enhances the heat transfer via convection. The available load current vs. ambient air temperature and airflow at $V_{in}=53\text{ V}$ for each model is according to the information given under the output section. The test is done in a wind tunnel with a cross section of 305x305mm, the DC/DC converter vertically mounted on a 6 layer PCB with a size of 254x254mm. Proper cooling can be verified by measuring the temperature of selected devices. Peak temperature can occur at position P1 and P2. The temperature at these positions should not exceed the recommended max values.

Position	Device	$T_{critical}$	Recommended Max Value
P1	FR4 PWB	$T_{surface}$	125°C
P2	Transformer	T_{core}	125°C

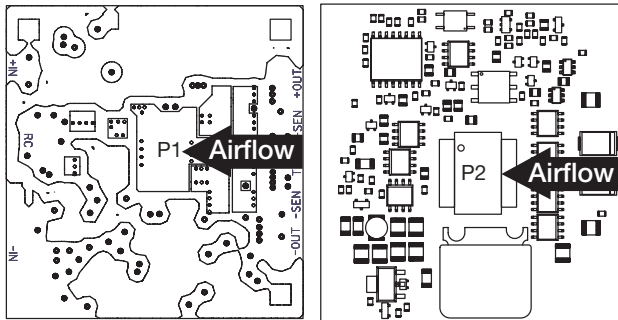

Calculation of ambient temperature

By using the thermal resistance the maximum allowed ambient temperature can be calculated.

1. The powerloss is calculated by using the formula $((1/\eta) - 1) \times \text{output power} = \text{power losses}$.
 η = efficiency of converter. E.g 89% = 0.89
2. Find the value of the thermal resistance in the diagram by using the airflow speed at the module. Take the thermal resistance x powerloss to get the temperature increase.

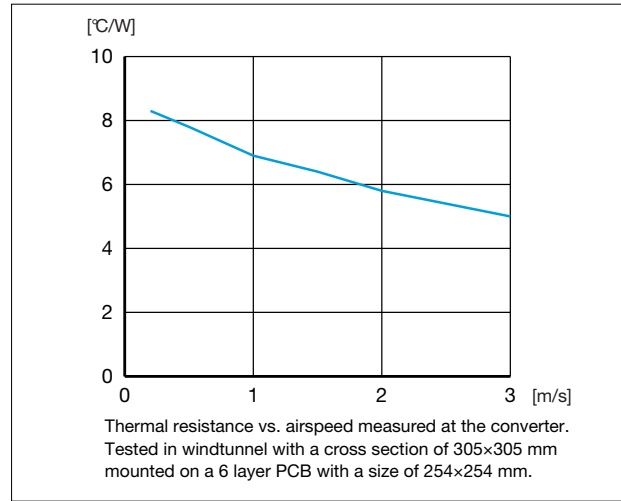

3. Max allowed calculated ambient temperature is: $\text{Max } T_{PCB} \text{ of DC/DC converter} - \text{temperature increase}$.

E.g PKJ 4810E PI at 1m/s:

A. $((\frac{1}{0.89}) - 1) \times 82.5\text{W} = 10.2\text{W}$

B. $10.2\text{W} \times 7.0^\circ\text{C/W} = 71.4^\circ\text{C}$

C. $125^\circ\text{C} - 71.4^\circ\text{C} = \text{max ambient temperature is } 53.6^\circ\text{C}$

The real temperature will be dependent on several factors, like PCB size and type, direction of airflow, air turbulence etc. It is recommended to verify the temperature by testing.

Miscellaneous

Soldering Information

The PKJ 4000E Series DC/DC converters are intended for through hole mounting on a PCB. When wave soldering is used max temperature on the pins are specified to 215°C for 10 seconds. Maximum preheat rate of 4°C/s is suggested. When hand soldering is used a thermocouple needs to be mounted on the DC/DC converter pins to verify that pin temperatures does not exceed 215°C for longer time than 10 seconds with the used soldering tools.

No-clean flux is recommended to avoid entrapment of cleaning fluids in cavities inside of the DC/DC power module. The residues may affect long time reliability and isolation voltage.

Delivery Package Information

PKJ 4000E series standard delivery package is a 50 pcs box (One box contains 5 full trays and 1 empty hold down tray).

Tray Specification

Material:	Polystyrene (PS)
Max surface resistance:	10 MOhm/sq
Color:	Black
Capacity:	10 pcs/tray
Loaded tray stacking pitch:	15.3 mm
Weight:	133 g

Design for Environment (DfE)

The PKJ 4000E Series DC/DC converters are designed to fulfil the wanted functionality with minimum environmental impact. The low weight high efficiency converters are assembled by using lead free solder and a PCB with halogen free flame retardant and Electroless Nickel Immersion Gold (ENIG) plating. The converters are shipped in a recyclable package.

Quality

Reliability

The Mean Time Between Failure (MTBF) of the PKJ 4000E series DC/DC converter family is calculated to be greater than (>) 7.6 million hours at full output power and a PCB temperature of +110°C using the Ericsson failure rate data system (TILDA/Preditool). The Ericsson failure rate data system is based on field failure rates and is continuously updated. The data corresponds to actual failure rates of components used in Information Technology and Telecom equipment in temperature controlled environments ($T_A = -5...+65^\circ\text{C}$). The data is considered to have a confidence level of 90%. For more information please refer to Design Note 002.

Quality Statement

The PKJ 4000E series DC/DC converters are designed and manufactured in an industrial environment where quality systems and methods like ISO 9000, 6 σ (sigma), and SPC are intensively in use to boost the continuous improvements strategy. Infant mortality or early failures in the products are screened out and they are subjected to an ATE-based final test. Conservative design rules, design reviews and product qualifications, plus the high competence of an engaged work force, contribute to the high quality of our products.

Warranty

Ericsson Power Modules warrants to the original purchaser or end user that the products conform to this Data Sheet and are free from material and workmanship defects for a period of five (5) years from the date of manufacture, provided the product is used within specified conditions and not modified in any way.

In case the product is discontinued, claims will be accepted up to three (3) years from the date of the discontinuation.

For additional details on this limited warranty we refer to Ericsson Power Modules "General Terms and Conditions of Sales", or individual contract documents.

Limitation of Liability

Ericsson Power Modules does not make any other warranties, expressed or implied including any warranty of merchantability or fitness for a particular purpose (including, but not limited to, use in life support applications, where malfunctions of product can cause injury to a person's health or life).

Product Program

V_I	V_O/I_O max	P_O max	Ordering No.
	Output 1		
48/60	2.5 V/30 A	75.5 W	PKJ 4719E PI
48/60	3.3 V/25 A	82.5 W	PKJ 4810E PI
48/60	5 V/20 A	100 W	PKJ 4711E PI

The PKJE series DC/DC converter may be ordered with different options listed in the Product Options Table.

For more information about the complete product program, please refer to our website: www.ericsson.com/powermodules

Product Options

Option	Suffix	Ordering No.
Positive Remote control logic	P	PKJ 4810E PIP
Pin length 3.6 mm (0.14 in)	LA	PKJ 4810E PILA

Note: As an example a positive logic, short pin product would be PKJ 4810E PIPLA

Information given in this data sheet is believed to be accurate and reliable. No responsibility is assumed for the consequences of its use nor for any infringement of patents or other rights of third parties which may result from its use. No license is granted by implication or otherwise under any patent or patent rights of Ericsson Power Modules. These products are sold only according to Ericsson Power Modules' general conditions of sale, unless otherwise confirmed in writing. Specifications subject to change without notice.

Ericsson Power Modules
SE-141 75 Kungens Kurva, Sweden
Telephone: +46 8 568 69620

For local sales contacts, please refer to our website
www.ericsson.com/powermodules
or call: Int +46 8 568 69620, Fax: +46 8 568 69599

Americas
Ericsson Inc., Power Modules
+1-877-374-2642

Asia/Pacific
Ericsson Ltd.
+852-2590-7152

The latest and most complete information can be found on our website

Datasheet

EN/LZT 146 025 R2A
© Ericsson Power Modules AB, May 2003