

## DC/DC power modules 5 V/2 A/10W

- SMD and through-hole versions with ultra low component height 8.0 mm (0.315 in.)
- 83% efficiency
- 1,500 Vdc isolation voltage
- Switching frequency synchronization
- MTTF >10 million hours at +50°C case temperature
- Low EMI



The MacroDens™ 10W PKF 4111A I true component level on-board DC/DC power modules are intended as distributed power sources in decentralized –48 and –60VDC power systems. They are optimized for an operational ambient temperature range in compliance with present and future application needs, including non temperature controlled environments.

The mechanical design offers the choice of surface mount or through-hole versions, delivered in ready-to-use tubes, trays or tape & reel package, and compatibility with semi and fully aqueous cleaning processes.

*For mechanical and other information please refer to the PKF series General information data sheet.*

## Absolute Maximum Ratings

Characteristics		min	max	Unit
T <sub>C</sub>	Case temperature at full output power	-45	+100	°C
T <sub>S</sub>	Storage temperature	-55	+125	°C
V <sub>I</sub>	Continuous input voltage <sup>1)</sup>	-0.5	+75	Vdc
V <sub>ISO</sub>	Isolation voltage (input to output test voltage)	1,500		Vdc
E <sub>tr</sub>	Transient input energy		0.01	Ws
V <sub>RC</sub>	Remote control voltage pin 11 ref. to pin 17	-5	+16	Vdc
V <sub>adj</sub>	Output adjust voltage pin 8 ref. to pin 17	-5	+40	Vdc

Stress in excess of Absolute Maximum Ratings may cause permanent damage. Absolute Maximum Ratings, sometimes referred to as no destruction limits, are normally tested with one parameter at a time exceeding the limits of Output data or Electrical Characteristics. If exposed to stress above these limits, function and performance may degrade in an unspecified manner.

Input T<sub>C</sub> < T<sub>Cmax</sub> unless otherwise specified

Characteristics		Conditions	min	typ	max	Unit
V <sub>I</sub>	Input voltage range <sup>1)2)</sup>		38		72	V
V <sub>Ioff</sub>	Turn-off input voltage	See typical characteristics	30.0	34.5	36.0	V
V <sub>Ion</sub>	Turn-on input voltage	See typical characteristics	32.0	36.0	38.0	V
C <sub>I</sub>	Input capacitance			1.4		μF
P <sub>li</sub>	Input idling power	I <sub>O</sub> =0, T <sub>C</sub> =-30...+95 °C	(V <sub>I</sub> =53V) (V <sub>I</sub> =66V)		400 400	mW
P <sub>RC</sub>	Input stand-by power	T <sub>C</sub> =-30...+95 °C, RC connected to pin 17	(V <sub>I</sub> =53V) (V <sub>I</sub> =66V)	30 45		mW

### Notes:

- 1) The input voltage range 38...72Vdc meets the European Telecom Standard prETS 300 132-2 Nominal input voltage range in 48V and 60 Vdc power systems, -40.5...-57.0V and -50.0...-72.0V respectively. Absolute max continuous input voltage is 75 Vdc.
- 2) The power modules will operate down to ≤36V, when V<sub>I</sub> decreases, but will turn on at V<sub>I</sub> ≤38V, when V<sub>I</sub> increases (see also Operating information).

## Connections

Pin	Designation	Function
1	Out 1	Output 1(+).
2	Rtn	Output return.
3-6	NC	Not connected. Galvanically Isolated from input pins.
7	Sync	Synchronization input
8	V <sub>adj</sub>	Output voltage adjust.
9	NOR	Connection of Nominal Output voltage Resistor.
10	TOA	Turn-on/off input voltage adjust.
11	RC	Remote control and turn-on/off input voltage adjust.
12-16	NC	Not connected. Galvanically isolated from input pins.
17	-In	Negative input.
18	+In	Positive Input.

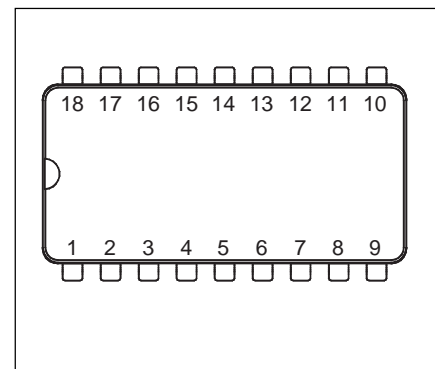

## Safety

The PKF 4111A I series DC/DC power modules are designed in accordance with EN 60 950, *Safety of information technology equipment including electrical business equipment*. The PKF power modules are recognized by UL and meet the applicable requirements in UL 1950 *Safety of information technology equipment*, the applicable Canadian safety requirements and UL 1012 *Standard for power supplies*. The DC/DC power module shall be installed in an end-use equipment and considerations should be given to measuring the case temperature to comply with  $T_{C,max}$  when in operation. Abnormal component tests are conducted with the input protected by an external 15 A fuse. The need for repeating these tests in the end-use appliance shall be considered if installed in a circuit having higher rated devices.

When the supply to the DC/DC power module meets all the requirements for SELV (<60 V dc), the output is considered to remain within SELV limits (level 3). The isolation is an operational insulation in accordance with EN 60 950.

The DC/DC power module is intended to be supplied by isolated secondary circuitry and shall be installed in compliance with the requirements of the ultimate application. If they are connected to a 60 V DC system reinforced insulation must be provided in the power supply that isolates the input from the mains. Single fault testing in the power supply must be performed in combination with the DC/DC power module to demonstrate that the output meets the requirement for SELV. One pole of the input and one pole of the output is to be grounded or both are to be kept floating. The terminal pins are only intended for connection to mating connectors of internal wiring inside the end-use equipment. These DC/DC power modules may be used in telephone equipment in accordance with paragraph 34 A.1 of UL 1459 (Standard for Telephone Equipment, second edition).

The galvanic isolation is verified in an electric strength test. Test voltage ( $V_{ISO}$ ) between input and output is 1,500 Vdc for 60 s. In production the test duration may be decreased to 1 s. The capacitor between input and output has a value of 1 nF and the leakage current is less than 1 $\mu$ A @ 53 Vdc. The case is designed in non-conductive epoxy. Its flammability rating meets UL 94V-0. The oxygen index is 34%.

## Electrical Data

### Fundamental circuit diagram

#### Single output

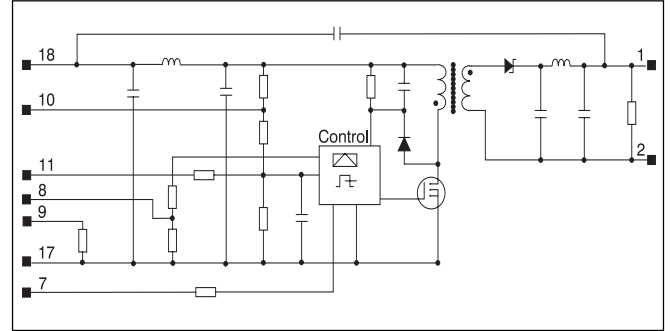

### Transient input voltage

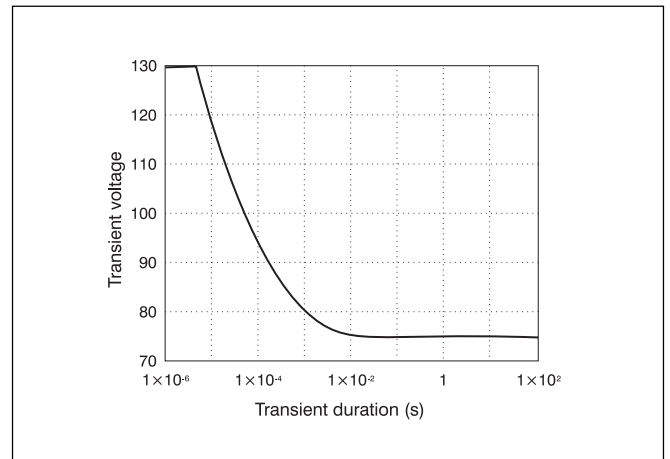

Single voltage pulse at +25°C ambient temperature.

## Output

$T_C = -30 \dots +95^\circ\text{C}$ ,  $V_I = 38 \dots 72\text{V}$  and pin 8 connected to pin 9.

Characteristics		Conditions		Output 1			Unit
				min	typ	max	
$V_{O_i}$	Output voltage initial setting and accuracy	$T_C = +25^\circ\text{C}$ , $I_O = 1.5\text{ A}$ , $V_I = 53\text{ V}$		5.02	5.05	5.08	V
	Output adjust range <sup>1)</sup>			2.62		6.39	V
$V_O$	Output voltage tolerance band	Long term drift included	$I_O = 0.2 \dots 2.0\text{ A}$	4.85		5.25	V
	Idling voltage	$I_O = 0\text{ A}$			5.8	6.0	V
	Line regulation	$I_O = 2\text{ A}$	$V_I = 38 \dots 60\text{ V}$		20		mV
			$V_I = 50 \dots 72\text{ V}$		6		
Load regulation	$I_O = 0.2 \dots 2.0\text{ A}$ , $V_I = 53\text{ V}$		50	80	180	mV	
$t_{tr}$	Load transient recovery time	$I_O = 0.2 \dots 2.0\text{ A}$ , $V_I = 53\text{ V}$ load step = 1 A			150		$\mu\text{s}$
$V_{tr}$	Load transient voltage			+150		mV	
				-250		mV	
$T_{coeff}$	Temperature coefficient <sup>2)</sup>	$I_O = 2\text{ A}$ , $T_C = +40 \dots +90^\circ\text{C}$			-1.3		mV/ $^\circ\text{C}$
$t_r$	Ramp-up time	$I_O = 0.2 \dots 2.0\text{ A}$ , $0.1 \dots 0.9 \times V_O$ , $V_I = 53\text{ V}$			2		ms
$t_s$	Start-up time	$I_O = 0.2 \dots 2.0\text{ A}$ , $V_I = 53\text{ V}$ From $V_I$ connection to $V_O = 0.9 \times V_{O_i}$			5		ms
$I_O$	Output current			0		2.0	A
$P_{Omax}$	Max output power <sup>2)</sup>	Calculated value		10			W
$I_{lim}$	Current limiting threshold	$T_C < T_{Cmax}$ , $V_O = 4.0\text{ V}$		2.15		2.60	A
$I_{sc}$	Short circuit current	$V_O = 0.2 \dots 0.5\text{ V}$ , $T_C = +25^\circ\text{C}$			3.0		A
$V_{Oac}$	Output ripple & noise	$I_O = 2\text{ A}$	20 Hz...5 MHz		20	50	mV <sub>p-p</sub>
			0.6 ...50 MHz			80	dB $\mu\text{V}$
SVR	Supply voltage rejection (ac)	f = 100 Hz sine wave, 1V <sub>p-p</sub> , $V_I = 53\text{ V}$ (SVR = 20 log (1 V <sub>p-p</sub> /V <sub>O(p-p)</sub> ))			50		dB

<sup>1)</sup> See also Operating Information.

<sup>2)</sup> See Typical Characteristics.

## Miscellaneous

Characteristics		Conditions		min	typ	max	Unit
$\eta$	Efficiency	$I_O = 2\text{ A}$	$V_I = 53\text{ V}$	78	83		%
			$V_I = 66\text{ V}$	78	81		
$P_d$	Power dissipation		$V_I = 53\text{ V}$			2.8	W
			$V_I = 66\text{ V}$			2.8	

# Typical Characteristics

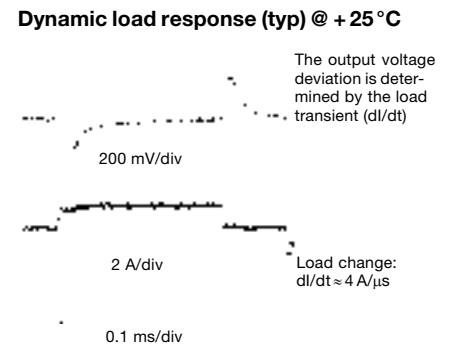
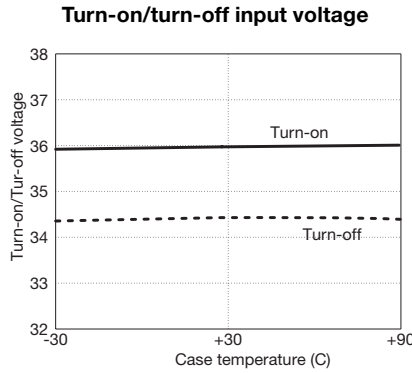
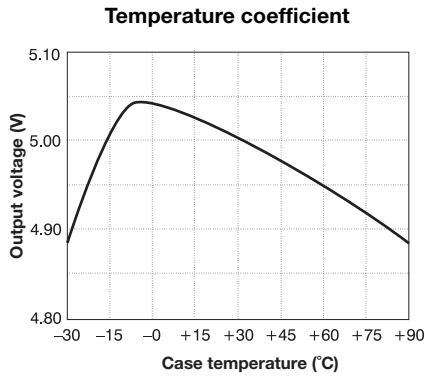
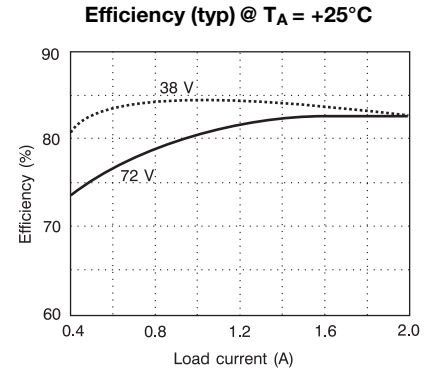
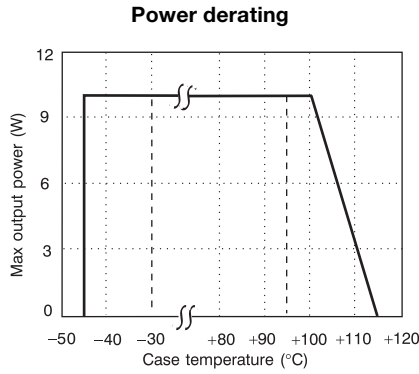
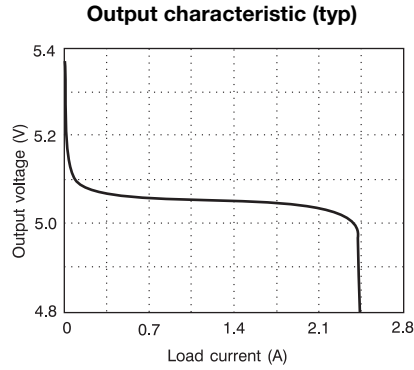

## EMC Specifications

During EMC measurements the PKF module is measured directly. The fundamental switching frequency is 510 kHz ±5% @ I<sub>O</sub> = (0.1...1.0) × I<sub>Omax</sub>.

### Conducted EMI (input terminals)

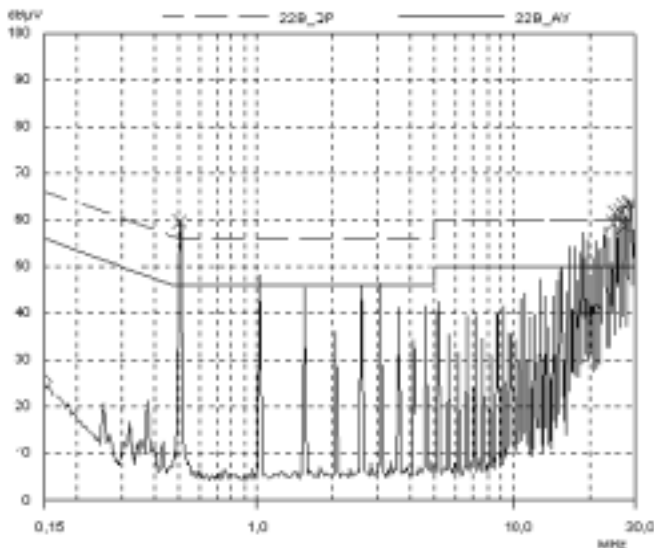

PKF 4111A without filter.

## External Filter (class B)

Required external input filter in order to meet class B in EN 55022, CISPR 22 and FCC part 15J.

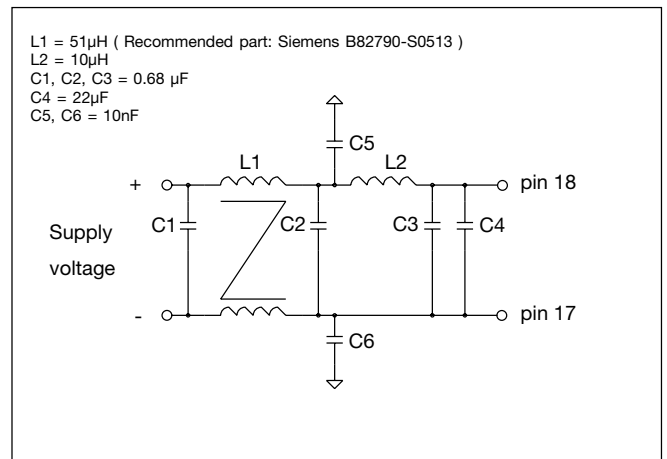

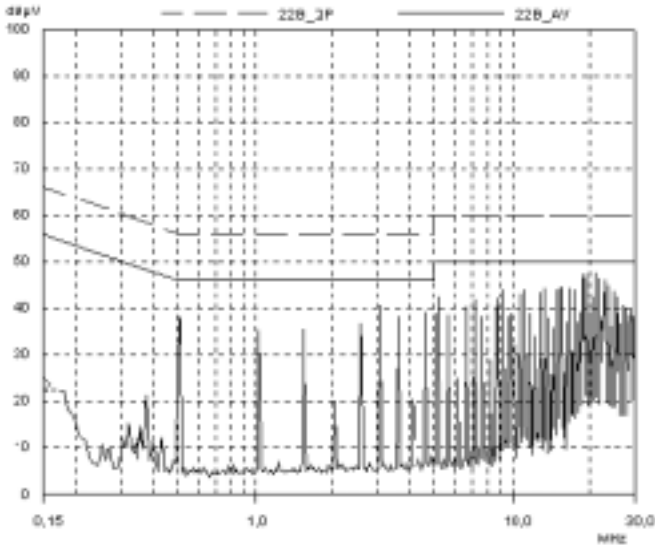

PKF 4111A with filter.

### Conducted EMS

Electro Magnetic Susceptibility is measured by injection of electrical disturbances on the input terminals. No deviation outside the  $V_O$  tolerance band will occur under the following conditions:

Frequency range	Voltage level
0.15...300 MHz	1.0 $V_{rms}$

The signal is amplitude modulated with 1 kHz/80% and applied in both differential and common mode.

### Radiated EMS (Electro-Magnetic Fields)

Radiated EMS is measured according to test methods in IEC Standard publ. 801-3. No deviation outside the  $V_O$  tolerance band will occur under the following conditions:

Frequency range	Voltage level
0.01...200 MHz	3 $V_{rms}/m$
200...1,000 MHz	3 $V_{rms}/m$
1...12 GHz	10 $V_{rms}/m$

### ESD

Electro Static Discharge is tested according to IEC publ. 801-2. No destruction will occur if the following voltage levels are applied to any of the terminal pins:

Test	Voltage level
Air discharge	$\pm 4$ kV
Contact discharge	$\pm 2$ kV

### EFT

Electrical Fast Transients on the input terminals could affect the output voltage regulation causing functional errors on the Printed Board Assembly (PBA). The PKF power modules withstand EFT levels of 0.5 kV keeping  $V_O$  within the tolerance band and 2.0 kV without destruction. Tested according to IEC publ. 801-4.

### Output Ripple & Noise ( $V_{Oac}$ )

Output ripple is measured as the peak to peak voltage of the fundamental switching frequency.

## Operating Information

### Fuse Considerations

To prevent excessive current from flowing through the input supply line, in the case of a short-circuit across the converter input, an external fuse should be installed in the non-earthed input supply line. We recommend using a fuse rated at approximately 2 to 4 times the value calculated in the formula below:

$$I_{in,max} = \frac{P_{O,max}}{(\eta_{min} \times V_{I,min})}$$

Refer to the fuse manufacturer for further information.

### Remote Control (RC)

Turn-on or turn-off can be realized by using the RC-pin. If pin 11 is connected to pin 17 the power modules turns off. Normal operation is achieved if pin 11 is open (NC). To ensure safe turn-off the voltage difference between pin 11 and 17 shall be less than 1.0V. RC is an open collector compatible input. A sink capacity of 1mA is needed. (see fig.1).

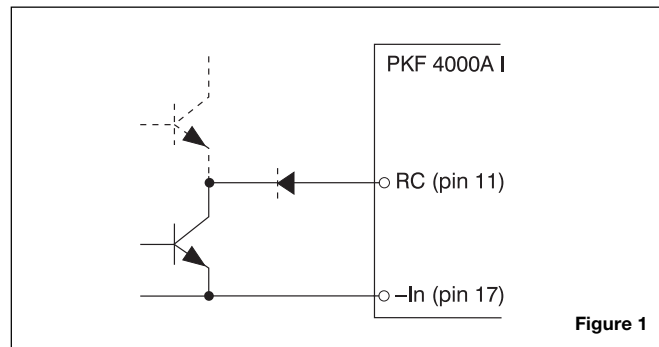

Figure 1

### Turn-on/off Input Voltage

The power module monitors the input voltage and will turn on and turn off at predetermined levels set by means of external resistors.

To increase  $V_{I,on}$  a resistor should be connected between pin 11 and 17 (see fig. 2).

The resistance is given by the following equation (For  $V_{I,on} > 36V$ ):

$$R_{I,on} = (2780 - V_{I,on}) / (V_{I,on} - 36.0) \text{ k}\Omega$$

$V_{I,off}$  is the adjusted turn-off input voltage and is determined by  $V_{I,on} - V_{I,off} = 2V$  (typical value).

To decrease  $V_{I,on}$  a resistor should be connected between pin 10 and 11 (see fig. 2). The resistance is given by the following equation (for  $34.5V < V_{I,on} < 36V$ ):

$$R_{I,on} = 49 \times (V_{I,on} - 32.0) / (36.0 - V_{I,on}) \text{ k}\Omega$$

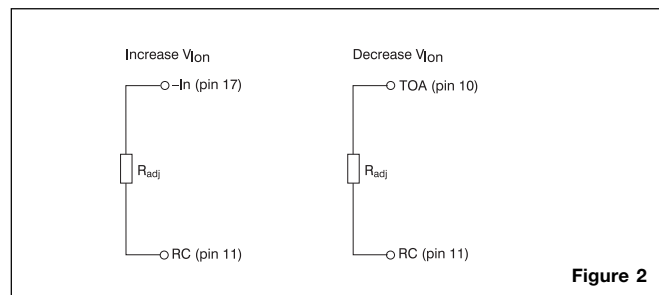

Figure 2

## Output Voltage Adjust ( $V_{adj}$ )

Output voltage,  $V_O$ , can be adjusted by using an external resistor or other external circuitry. If other circuitry is used, the slew rate has to be limited to maximum 5 V/ms. If pins 8 and 9 are not connected together the output will decrease to a low value. To increase  $V_O$  a resistor should be connected between pin 8/9 and 17, and to decrease  $V_O$  a resistor should be connected between pin 8 and 9 (see fig. 3).

Typical required resistor value to increase  $V_O$  is given by:

$$R_{adj} = 4.20 \times (6.39 - V_O) / (V_O - V_{O_i}) \text{ k}\Omega$$

where  $V_O$  is the desired output voltage,  
 $V_{O_i}$  is the typical output voltage initial setting

Typical required resistor value to decrease  $V_O$  is given by:

$$R_{adj} = 18.0 \times (V_{O_i} - V_O) / (V_O - 2.62) \text{ k}\Omega$$

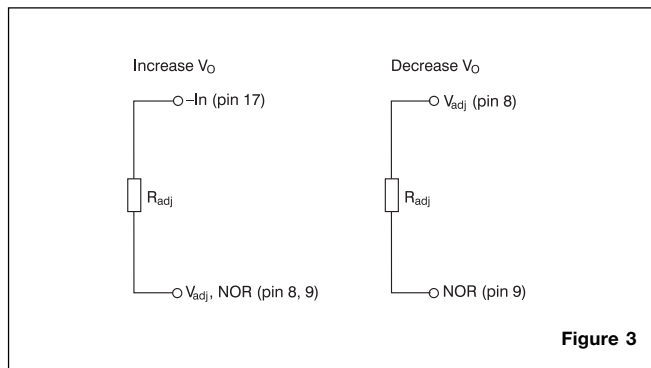

Figure 3

## Current Limiting Protection ( $I_{lim}$ )

The output power is limited at loads above the output current limiting threshold ( $I_{lim}$ ), specified as a minimum value.

## Capacitive Load

The PKF series has no maximum limit for capacitive load on the output. The power module may operate in current limiting mode during start-up, affecting the ramp-up and the start-up time. For optimum start performance we recommend maximum 100  $\mu\text{F}/\text{A}$  of  $I_O$ . Connect capacitors at the point of load for best performance.

## Input and Output Impedance

Both the source impedance of the power feeding and the load impedance will interact with the impedance of the DC/DC power module.

It is most important to have the ratio between L and C as low as possible, i.e. a low characteristic impedance, both at the input and output, as the power modules have a low energy storage capability.

Use an electrolytic capacitor across the input if the source inductance is higher than 10  $\mu\text{H}$ . Their equivalent series resistance together with the capacitance acts as a lossless damping filter. Suitable capacitor values are in the range 10–100  $\mu\text{F}$ .

## Synchronization (Sync)

It is possible to synchronize the switching frequency to an external symmetrical clock signal. The input can be driven by an TTL-compatible output and referenced to the input pin 17.

Characteristics	min	typ	max	unit
High level	2.2		6.5	V
Threshold level <sup>†)</sup>	1.2	1.7	2.2	V
Low level	0		0.4	V
Sink current			1.5	mA
Sync. frequency	520		688	kHz

<sup>†)</sup> Rise time <10ns

## Parallel Operation

Paralleling of several converters is easily accomplished by direct connection of the output voltage terminal pins. The load regulation characteristic is specifically designed for optimum paralleling performance. Load sharing between converters will be within  $\pm 10\%$ . It is recommended not to exceed  $P_O = n \times 0.9 \times P_{O_{max}}$ , where  $P_{O_{max}}$  is the maximum converter output power and n the number of paralleled converters, to prevent overloading any of the converters and thereby decreasing the reliability performance.

## Ordering Information

Version	Part No.
Surface mount	PKF 4111A SI
Through hole	PKF 4111A PI *

\* Optional PINS version without synchronization input.

Information given in this data sheet is believed to be accurate and reliable. No responsibility is assumed for the consequences of its use nor for any infringement of patents or other rights of third parties which may result from its use. No license is granted by implication or otherwise under any patent or patent rights of Ericsson Microelectronics. These products are sold only according to Ericsson Microelectronics' general conditions of sale, unless otherwise confirmed in writing. Specifications subject to change without notice.

**Ericsson Microelectronics**  
SE-164 81 KISTA, Sweden  
Phone: +46 8 757 5000  
[www.ericsson.com/microelectronics](http://www.ericsson.com/microelectronics)

For local sales contacts, please refer to our website  
or call: Int. +46 8 757 4700, Fax: +46 8 757 4776

The latest and most complete information can be found on our website

## Preliminary Data Sheet

EN/LZT 146 87 R1A  
© Ericsson Microelectronics AB, December 2001