

## POWER MOS 7® MOSFET

Power MOS 7® is a new generation of low loss, high voltage, N-Channel enhancement mode power MOSFETS. Both conduction and switching losses are addressed with Power MOS 7® by significantly lowering  $R_{DS(ON)}$  and  $Q_g$ . Power MOS 7® combines lower conduction and switching losses along with exceptionally fast switching speeds inherent with APT's patented metal gate structure.

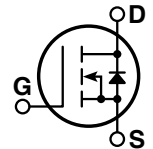
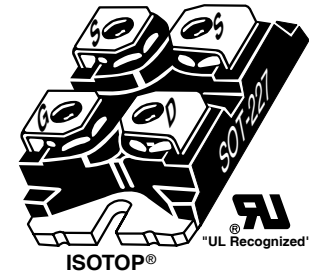

- Lower Input Capacitance
- Lower Miller Capacitance
- Lower Gate Charge,  $Q_g$
- Increased Power Dissipation
- Easier To Drive
- Popular SOT-227 Package

### MAXIMUM RATINGS

All Ratings:  $T_C = 25^\circ\text{C}$  unless otherwise specified.

Symbol	Parameter	APT5010JLL	UNIT
$V_{DSS}$	Drain-Source Voltage	500	Volts
$I_D$	Continuous Drain Current @ $T_C = 25^\circ\text{C}$	41	Amps
$I_{DM}$	Pulsed Drain Current <sup>①</sup>	164	
$V_{GS}$	Gate-Source Voltage Continuous	$\pm 30$	Volts
$V_{GSM}$	Gate-Source Voltage Transient	$\pm 40$	
$P_D$	Total Power Dissipation @ $T_C = 25^\circ\text{C}$	378	Watts
	Linear Derating Factor	3.03	W/ $^\circ\text{C}$
$T_J, T_{STG}$	Operating and Storage Junction Temperature Range	-55 to 150	$^\circ\text{C}$
$T_L$	Lead Temperature: 0.063" from Case for 10 Sec.	300	
$I_{AR}$	Avalanche Current <sup>①</sup> (Repetitive and Non-Repetitive)	41	Amps
$E_{AR}$	Repetitive Avalanche Energy <sup>①</sup>	35	mJ
$E_{AS}$	Single Pulse Avalanche Energy <sup>④</sup>	1600	

### STATIC ELECTRICAL CHARACTERISTICS

Symbol	Characteristic / Test Conditions	MIN	TYP	MAX	UNIT
$BV_{DSS}$	Drain-Source Breakdown Voltage ( $V_{GS} = 0V, I_D = 250\mu\text{A}$ )	500			Volts
$R_{DS(on)}$	Drain-Source On-State Resistance <sup>②</sup> ( $V_{GS} = 10V, I_D = 20.5A$ )			0.100	Ohms
$I_{DSS}$	Zero Gate Voltage Drain Current ( $V_{DS} = 500V, V_{GS} = 0V$ )			100	$\mu\text{A}$
	Zero Gate Voltage Drain Current ( $V_{DS} = 400V, V_{GS} = 0V, T_C = 125^\circ\text{C}$ )			500	
$I_{GSS}$	Gate-Source Leakage Current ( $V_{GS} = \pm 30V, V_{DS} = 0V$ )			$\pm 100$	nA
$V_{GS(th)}$	Gate Threshold Voltage ( $V_{DS} = V_{GS}, I_D = 2.5mA$ )	3		5	Volts

 **CAUTION:** These Devices are Sensitive to Electrostatic Discharge. Proper Handling Procedures Should Be Followed.

APT Website - <http://www.advancedpower.com>

**DYNAMIC CHARACTERISTICS**

**APT5010JLL**

Symbol	Characteristic	Test Conditions	MIN	TYP	MAX	UNIT
$C_{iss}$	Input Capacitance	$V_{GS} = 0V$ $V_{DS} = 25V$ $f = 1\text{ MHz}$		4360		pF
$C_{oss}$	Output Capacitance			895		
$C_{rss}$	Reverse Transfer Capacitance			60		
$Q_g$	Total Gate Charge ③	$V_{GS} = 10V$ $V_{DD} = 250V$ $I_D = 41A @ 25^\circ C$		95		nC
$Q_{gs}$	Gate-Source Charge			24		
$Q_{gd}$	Gate-Drain ("Miller") Charge			50		
$t_{d(on)}$	Turn-on Delay Time	<b>RESISTIVE SWITCHING</b> $V_{GS} = 15V$ $V_{DD} = 250V$ $I_D = 41A @ 25^\circ C$ $R_G = 0.6\Omega$		11		ns
$t_r$	Rise Time			13		
$t_{d(off)}$	Turn-off Delay Time			25		
$t_f$	Fall Time			3		
$E_{on}$	Turn-on Switching Energy ⑥	<b>INDUCTIVE SWITCHING @ 25°C</b> $V_{DD} = 333V, V_{GS} = 15V$ $I_D = 41A, R_G = 5\Omega$		485		$\mu J$
$E_{off}$	Turn-off Switching Energy			455		
$E_{on}$	Turn-on Switching Energy ⑥	<b>INDUCTIVE SWITCHING @ 125°C</b> $V_{DD} = 330V, V_{GS} = 15V$ $I_D = 41A, R_G = 5\Omega$		755		
$E_{off}$	Turn-off Switching Energy			530		

**SOURCE-DRAIN DIODE RATINGS AND CHARACTERISTICS**

Symbol	Characteristic / Test Conditions	MIN	TYP	MAX	UNIT
$I_S$	Continuous Source Current (Body Diode)			41	Amps
$I_{SM}$	Pulsed Source Current ① (Body Diode)			164	
$V_{SD}$	Diode Forward Voltage ② ( $V_{GS} = 0V, I_S = -41A$ )			1.3	Volts
$t_{rr}$	Reverse Recovery Time ( $I_S = -41A, di_S/dt = 100A/\mu s$ )		608		ns
$Q_{rr}$	Reverse Recovery Charge ( $I_S = -41A, di_S/dt = 100A/\mu s$ )		11.0		$\mu C$
$dv/dt$	Peak Diode Recovery $dv/dt$ ⑤			8	V/ns

**THERMAL CHARACTERISTICS**

Symbol	Characteristic	MIN	TYP	MAX	UNIT
$R_{\theta JC}$	Junction to Case			0.33	$^\circ C/W$
$R_{\theta JA}$	Junction to Ambient			40	

- ① Repetitive Rating: Pulse width limited by maximum junction temperature
- ② Pulse Test: Pulse width < 380  $\mu s$ , Duty Cycle < 2%
- ③ See MIL-STD-750 Method 3471
- ④ Starting  $T_j = +25^\circ C$ ,  $L = 1.90mH$ ,  $R_G = 25\Omega$ , Peak  $I_L = 41A$
- ⑤  $dv/dt$  numbers reflect the limitations of the test circuit rather than the device itself.  $I_S \leq -I_D 41A$   $di/dt \leq 700A/\mu s$   $V_R \leq V_{DSS}$   $T_j \leq 150^\circ C$
- ⑥  $E_{on}$  includes diode reverse recovery. See figures 18, 20.

APT Reserves the right to change, without notice, the specifications and information contained herein.

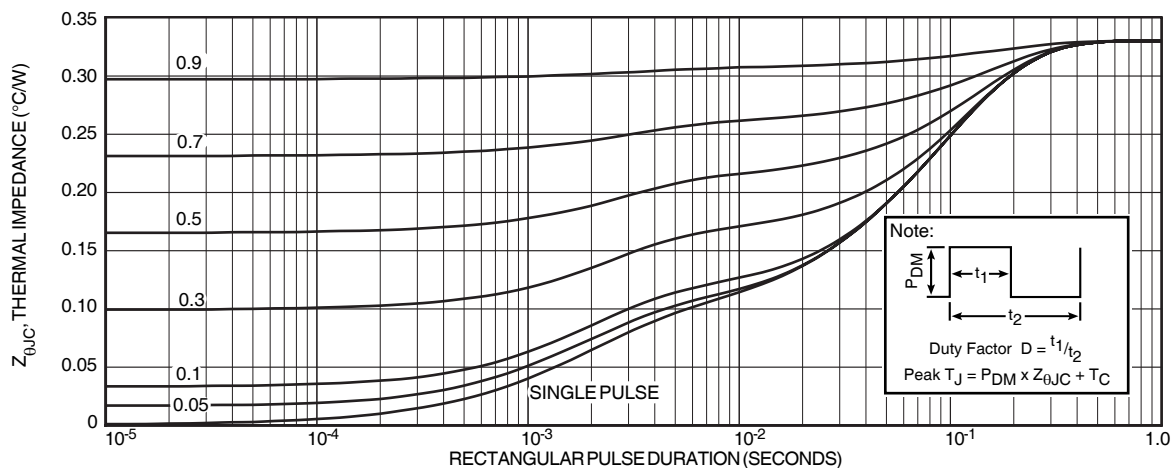

FIGURE 1, MAXIMUM EFFECTIVE TRANSIENT THERMAL IMPEDANCE, JUNCTION-TO-CASE vs PULSE DURATION

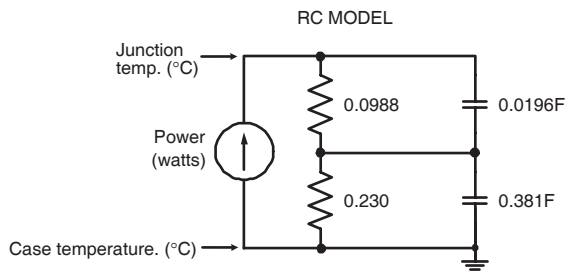

FIGURE 2, TRANSIENT THERMAL IMPEDANCE MODEL

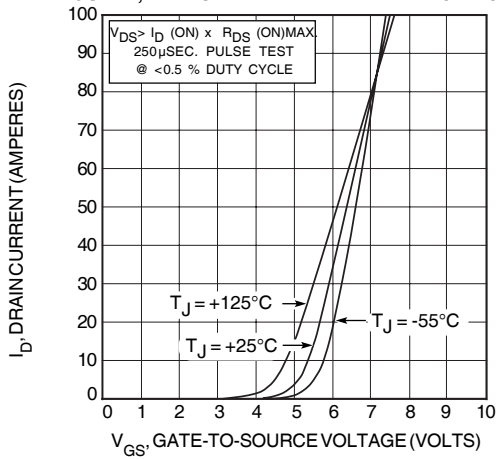

FIGURE 4, TRANSFER CHARACTERISTICS

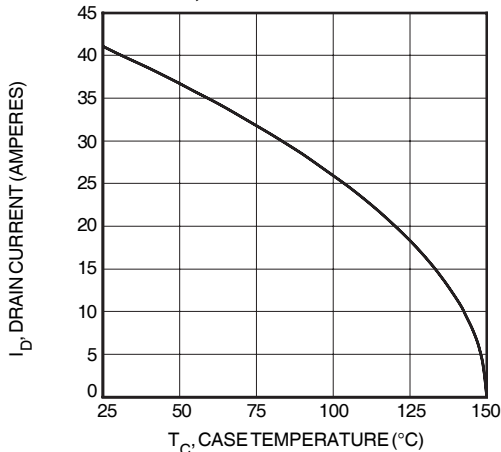

FIGURE 6, MAXIMUM DRAIN CURRENT vs CASE TEMPERATURE

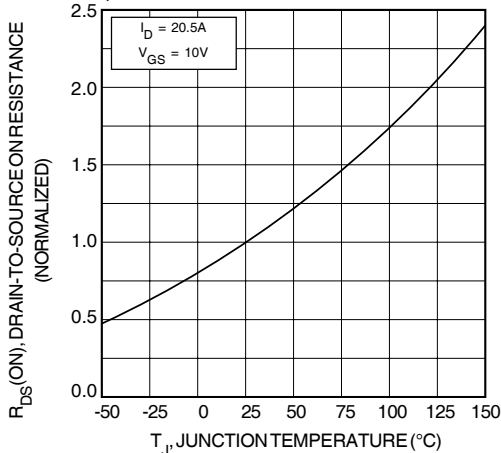

FIGURE 8, ON-RESISTANCE vs. TEMPERATURE

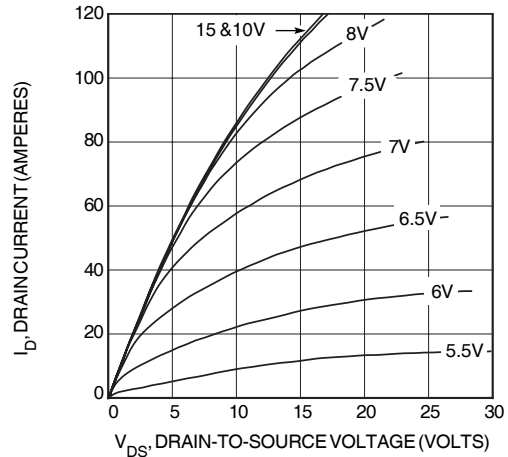

FIGURE 3, LOW VOLTAGE OUTPUT CHARACTERISTICS

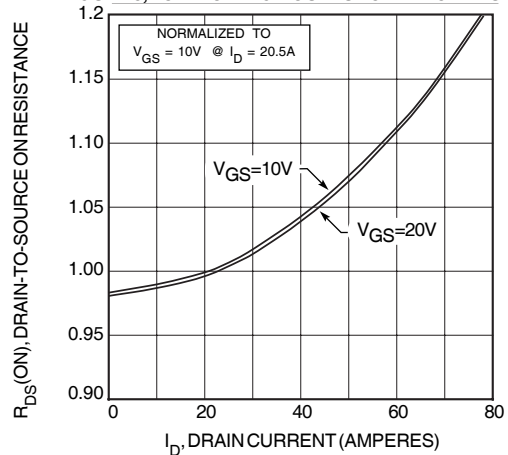

FIGURE 5,  $R_{DS}(ON)$  vs DRAIN CURRENT

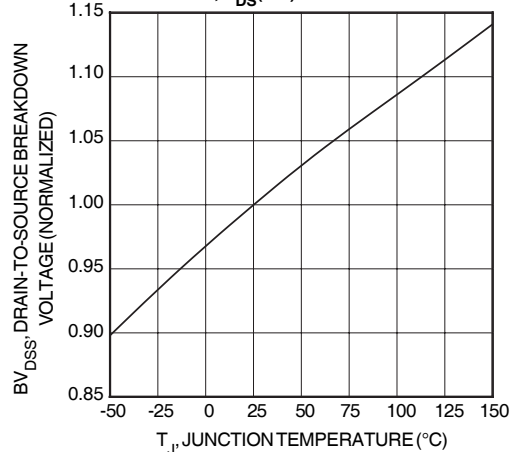

FIGURE 7, BREAKDOWN VOLTAGE vs TEMPERATURE

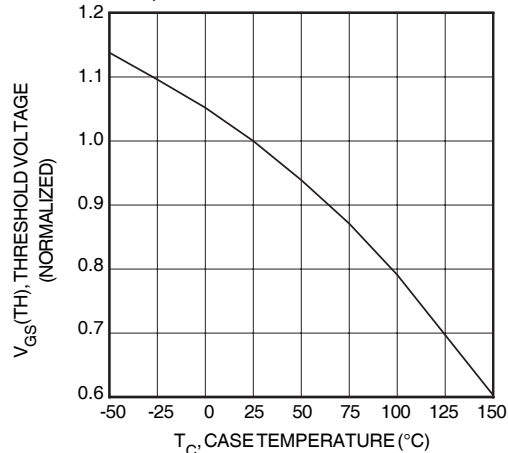

FIGURE 9, THRESHOLD VOLTAGE vs TEMPERATURE

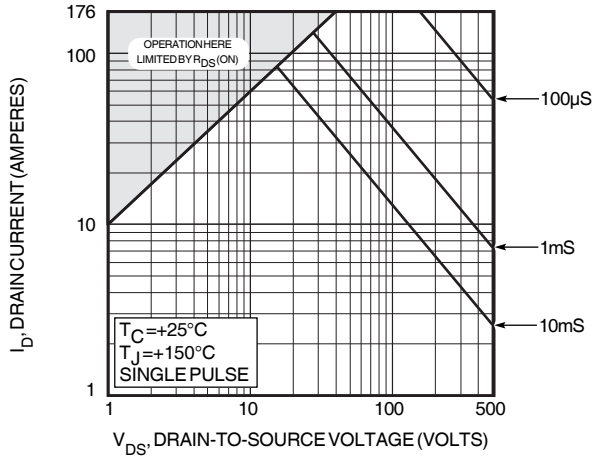

FIGURE 10, MAXIMUM SAFE OPERATING AREA

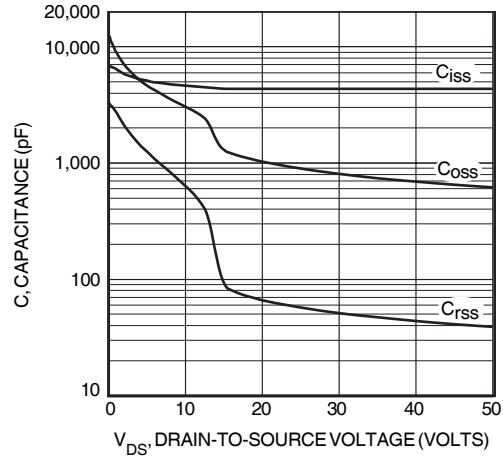

FIGURE 11, CAPACITANCE vs DRAIN-TO-SOURCE VOLTAGE

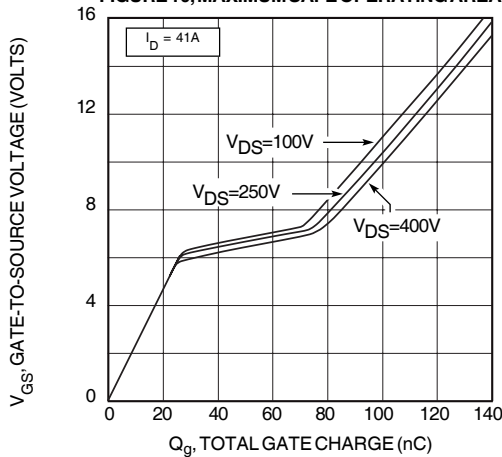

FIGURE 12, GATE CHARGES vs GATE-TO-SOURCE VOLTAGE

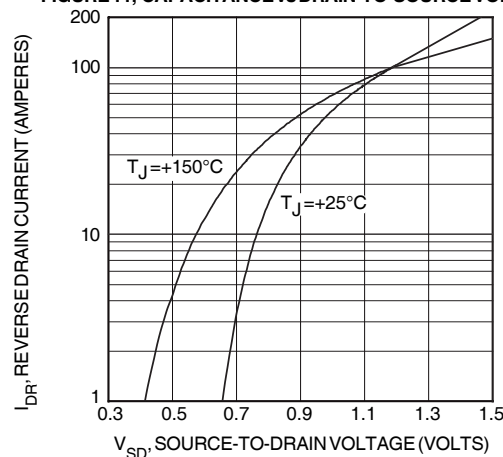

FIGURE 13, SOURCE-DRAIN DIODE FORWARD VOLTAGE

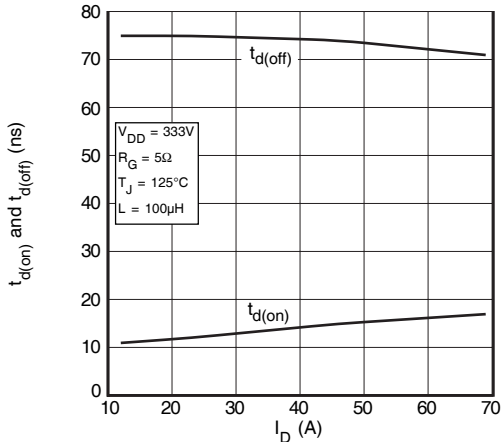

FIGURE 14, DELAY TIMES vs CURRENT

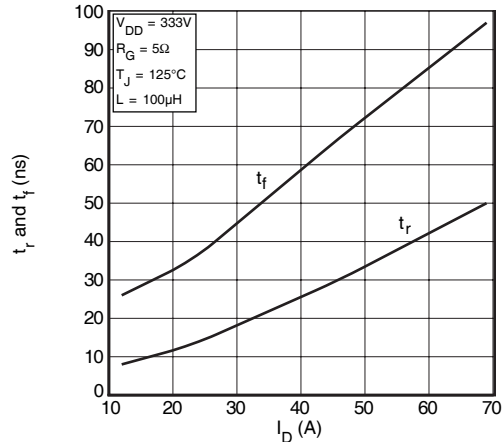

FIGURE 15, RISE AND FALL TIMES vs CURRENT

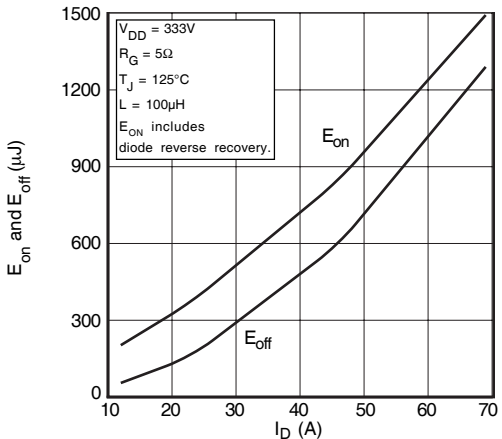

FIGURE 16, SWITCHING ENERGY vs CURRENT

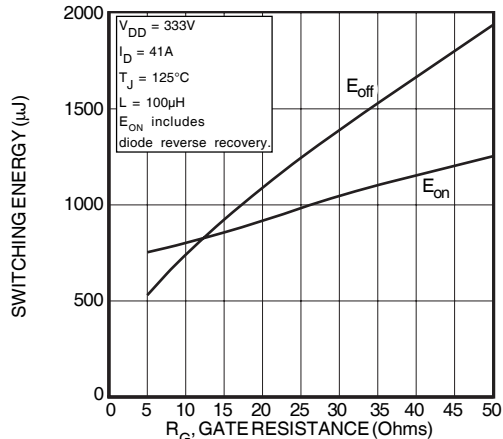

FIGURE 17, SWITCHING ENERGY vs. GATE RESISTANCE

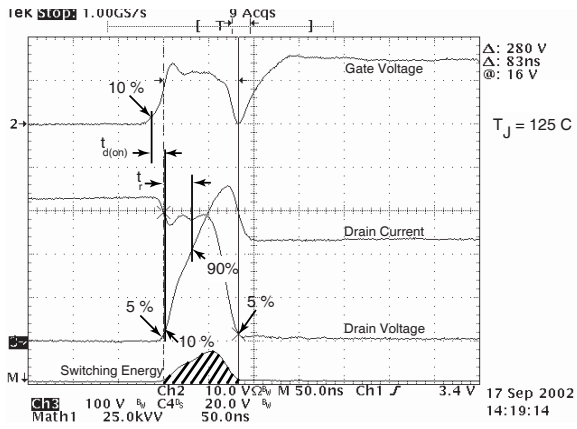

Figure 18, Turn-on Switching Waveforms and Definitions

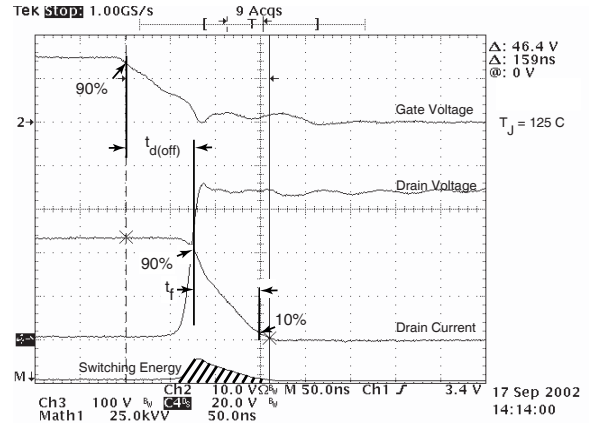

Figure 19, Turn-off Switching Waveforms and Definitions

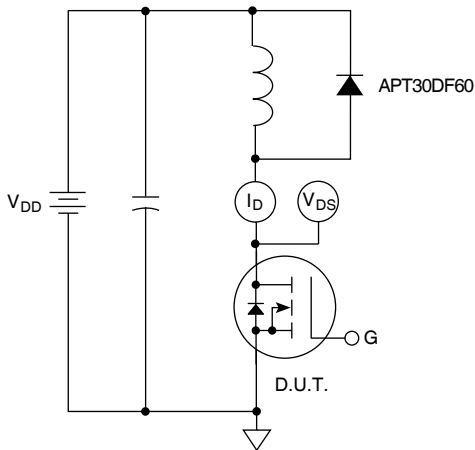
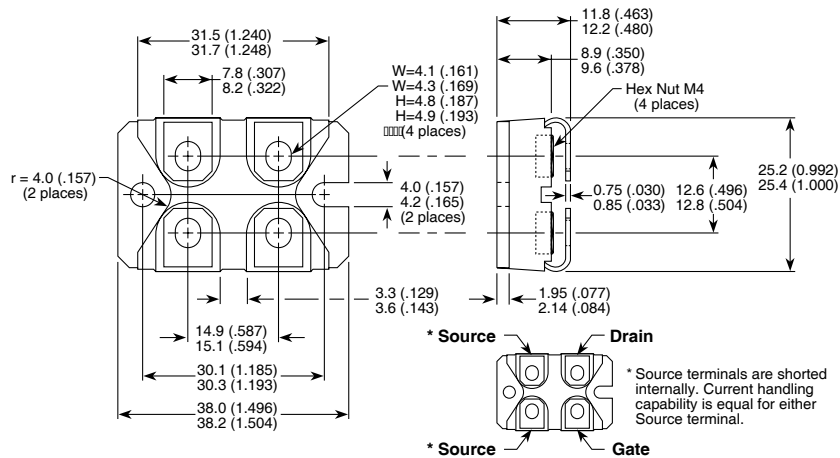

Figure 20, Inductive Switching Test Circuit

SOT-227 (ISOTOP®) Package Outline



Dimensions in Millimeters and (Inches)

ISOTOP® is a Registered Trademark of SGS Thomson. APT's products are covered by one or more of U.S. patents 4,895,810 5,045,903 5,089,434 5,182,234 5,019,522 5,262,336 6,503,786 5,256,583 4,748,103 5,283,202 5,231,474 5,434,095 5,528,058 and foreign patents. US and Foreign patents pending. All Rights Reserved.