



BIPOLAR ANALOG INTEGRATED CIRCUIT

μ PC1243C

AM TUNER

SILICON BIPOLAR MONOLITHIC INTEGRATED CIRCUIT

DESCRIPTION

μ PC1243C is a silicon monolithic integrated circuit designed for AM tuner and the most suitable for high class tuner. It is composed of an RF amplifier, a mixer, a local oscillator, an IF amplifier, a detector, a turn on and turn off pops canceller, an AGC amplifier and a signal meter driver. Package is the 16 lead Dual In-Line Plastic Package (DIP).

FEATURES

- Internally turn on and turn off pops canceller.
The pop level is one eighth that of NEC's conventional circuit.
- High signal to noise ratio.
 $S/N = 57$ dB TYP. ($V_{in} = 100$ dB/m, $f_{MOD} = 400$ Hz, MOD = 30 %)
- Low harmonic distortion in wide range of input level.
T.H.D. = 0.3 % TYP. ($V_{in} = 100$ dB/m, $f_{MOD} = 400$ Hz, MOD = 30 %)
T.H.D. = 0.9 % TYP. ($V_{in} = 130$ dB/m, $f_{MOD} = 400$ Hz, MOD = 80 %)
- A three-stage delay-type AGC.
- High tweet ratio.
Tweet ratio = 22 dB TYP. ($V_{in} = 60$ dB/m, 2 IF)
- High usable sensitivity.
U.S. = 46 dB/m TYP. ($f = 1$ MHz, S/N = 20 dB)
- Signal meter driver provides excellent linearity.
Driving current = 500 μ A MAX.

CONNECTION DIAGRAM (Top View)

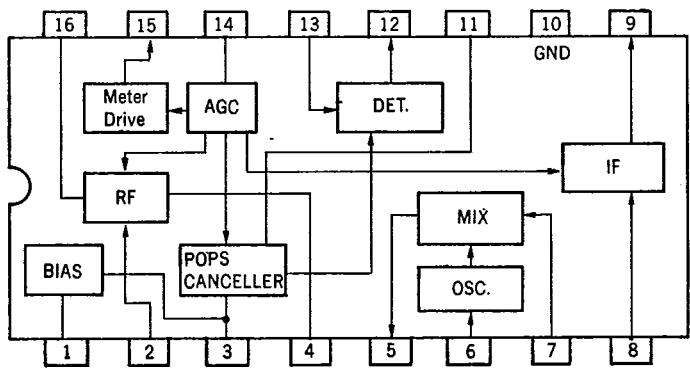

PACKAGE DIMENSIONS

in millimeters (inches)

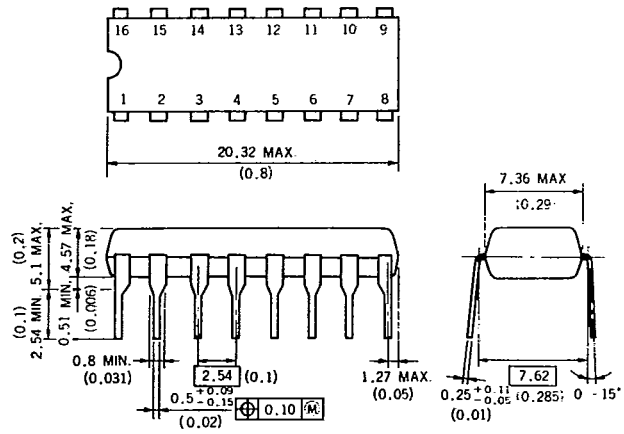

CONNECTIONS

Pin No.	Connection	Pin No.	Connection
1	Bias	9	IF output
2	RF input	10	GND
3	VCC	11	Timing condenser
4	RF output	12	DET. output
5	MIX output	13	DET. input
6	Local osc.	14	AGC input
7	MIX input	15	Signal meter
8	IF input	16	Bypass

EQUIVALENT CIRCUIT

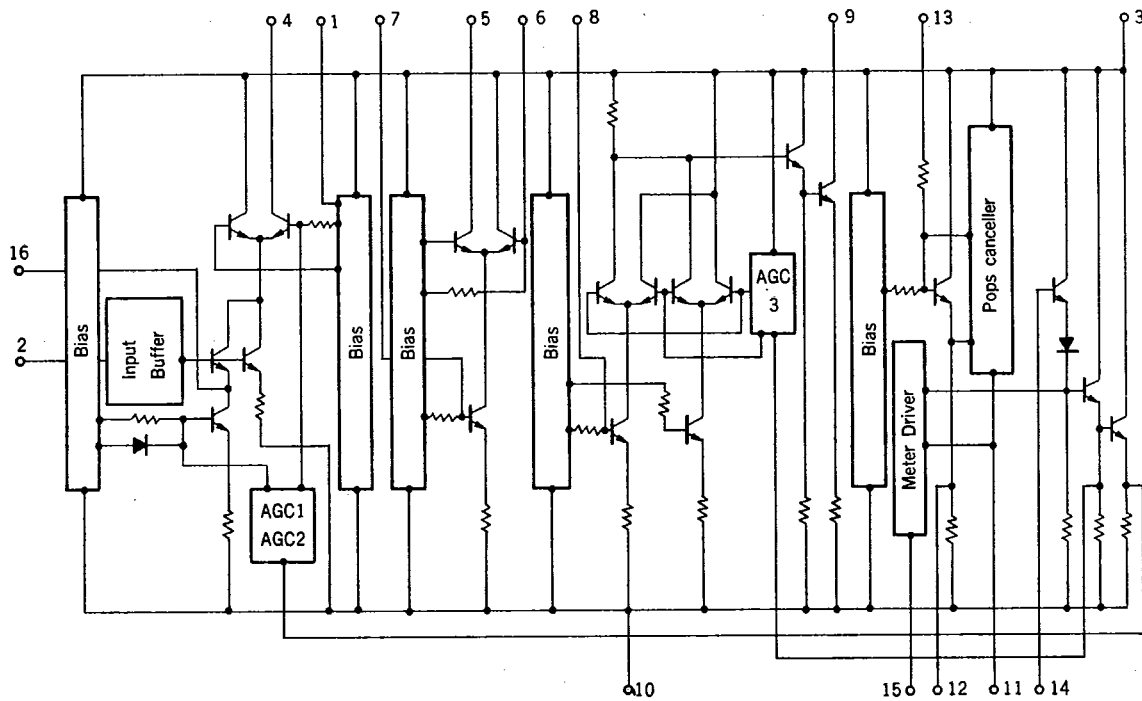

ABSOLUTE MAXIMUM RATINGS (T_a = 25 °C)

Supply Voltage	V _{CC}	15	V	
Input Voltage	V _{in}	7	V _{p-p}	
Power Dissipation	P _D	350	mW	(T _a = 75 °C)
Operating Temperature	T _{opt}	-20 to +75	°C	
Storage Temperature	T _{stg}	-40 to +125	°C	

RECOMMENDED OPERATING CONDITION (T_a = 25 °C)

CHARACTERISTIC	SYMBOL	MIN.	TYP.	MAX.	UNIT
Supply Voltage	V _{CC}	9	12	15	V

ELECTRICAL CHARACTERISTICS (T_a = 25 °C, V_{CC} = 12 V, f_{MOD} = 400 Hz, f = 1 MHz, MOD = 30 %)

CHARACTERISTIC	SYMBOL	MIN.	TYP.	MAX.	UNIT	TEST CONDITION
Supply Current	I _{CC}	10	14.5	21	mA	V _{in} = 0
Usable Sensitivity	U. Sens	-	46	-	dB/m	S/N = 20 dB
Detector Output	V _o	120	180	240	mV _{r.m.s.}	V _{in} = 100 dB/m
Harmonic Distortion	T.H.D. 1	-	0.3	0.8	%	V _{in} = 100 dB/m
Harmonic Distortion	T.H.D. 2	-	0.9	-	%	V _{in} = 130 dB/m, MOD = 80 %
AGC FOM	FOM	75	83	-	dB	-10 dB point
Signal to Noise Ratio	S/N	50	57	-	dB	V _{in} = 100 dB/m
Max. Sensitivity	M.S.	31	38	45	dB/m	V _o = 30 mV _{r.m.s.}

CHARACTERISTICS FOR REFERENCE (T_a = 25 °C, V_{CC} = 12.0 V)

CHARACTERISTIC	TYP.	UNIT	TEST CONDITION
IF Response Ratio	42	dB	f = 1 MHz, V _o = 50 mV _{r.m.s.} , IF = 455 kHz
Image Response Ratio	60	dB	f = 1 MHz, V _o = 50 mV _{r.m.s.} , f + 2 IF
Selectivity	30	dB	f = 1 MHz, Δf = ± 10 kHz
Tweet Ratio	22	dB	V _i = 60 dB/m, 2 IF = 910 kHz
	48	dB	V _i = 100 dB/m, 3 IF = 1 365 kHz
RF Input Impedance	5.5	kΩ	f = 1 MHz
RF Input Capacitance	5	pF	f = 1 MHz
RF Output Impedance	80	kΩ	f = 1 MHz
RF Output Capacitance	2	pF	f = 1 MHz
MIX Input Impedance	8	kΩ	f = 1 MHz
MIX Input Capacitance	5	pF	f = 1 MHz
MIX Output Impedance	80	kΩ	f = 1 MHz
MIX Output Capacitance	2	pF	f = 1 MHz
IF Input Impedance	3.3	kΩ	f = 455 kHz
IF Input Capacitance	10	pF	f = 455 kHz
IF Output Impedance	80	kΩ	f = 455 kHz
IF Output Capacitance	2	pF	f = 455 kHz
Det. Input Impedance	6.5	kΩ	f = 455 kHz
Det. Input Capacitance	5	pF	f = 455 kHz

COIL SPECIFICATION (Bottom view)

(1) OSC Coil RWR-43208N (TOKO Co.)

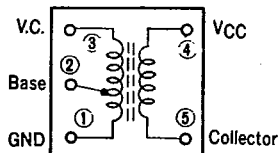

Qu = 110 ~ (796 kHz)
 ① ~ ② ② ~ ③ ④ ~ ⑤
 4T 58T 10T
 L = 160 μH ± 6 %

(2) IFT₁ (IF transformer) CFT455B (TOKO Co.)

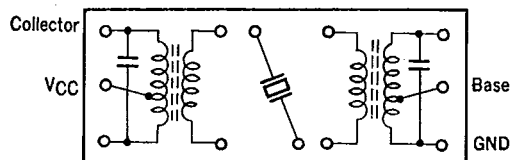

Centre freq. 455 kHz ± 3.5 kHz
 Selectivity ± 10 kHz 26 dB Mini.

(3) IFT₂ (IF transformer) RMC-43198C (TOKO Co.)

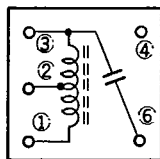

Centre freq. 455 kHz
 180 pF (Included)
 Qu = 80 ~ (455 kHz)
 ① ~ ③
 164T

(4) Bar antenna AR12 φ-120 (Coil Snake Co.)

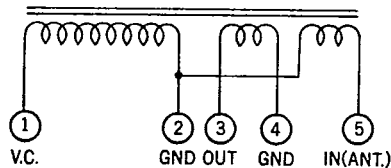

① ~ ② ③ ~ ④ ② ~ ⑤
 58T 6T 5T

(5) Air variable FB621U (Alps Electric Co.)
 Capacitor

C_{MAX.} = 326 pF
 C_{MIN.} = 9 pF

EXAMPLE FOR PRINTED CIRCUIT BOARD (Copper foil side)

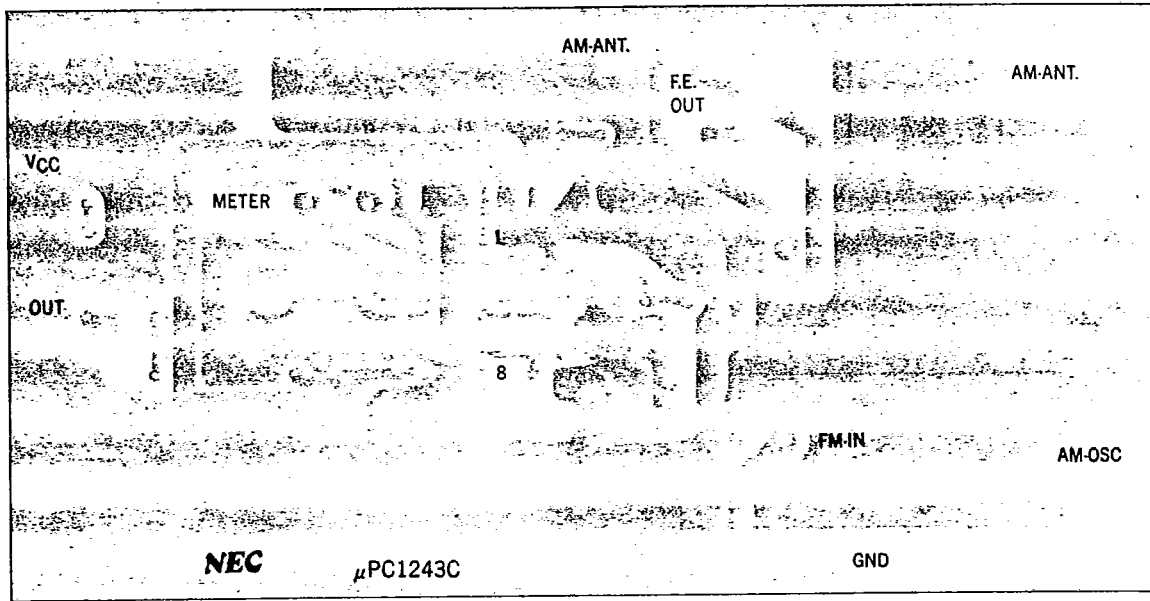

COMPONENT LAYOUT (Copper foil side)

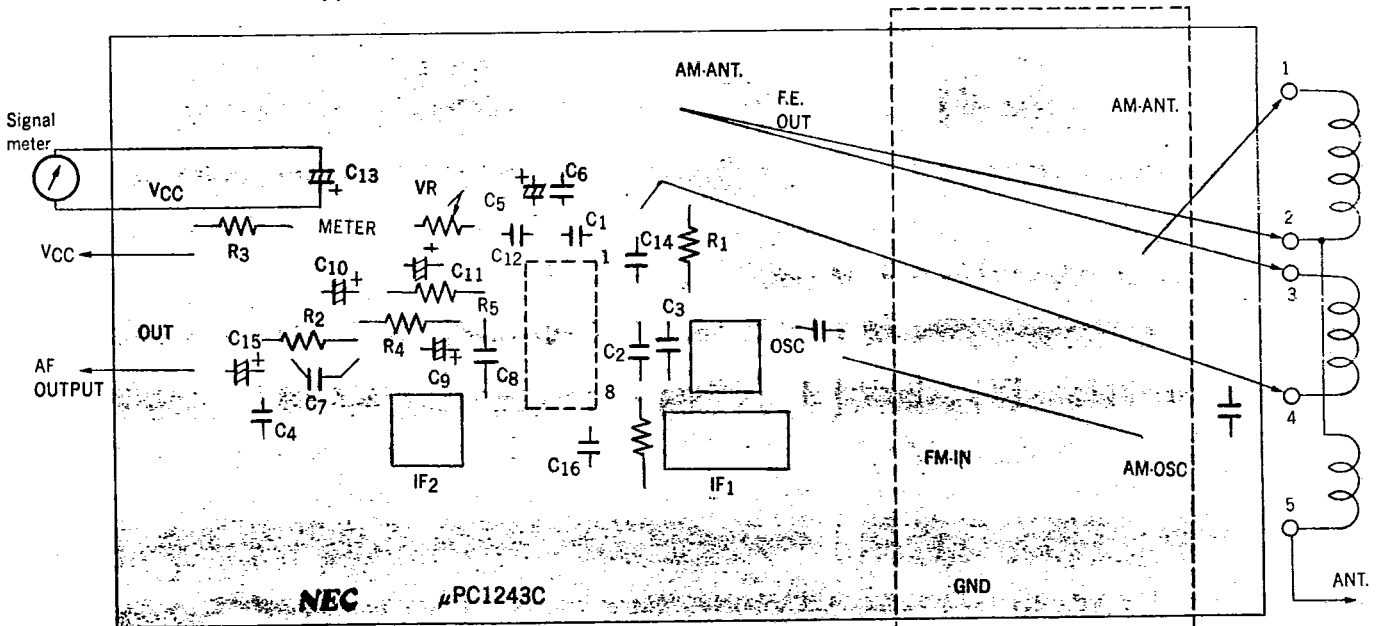

- R1 : 1kΩ
- R2 : 2.2 kΩ
- R3 : 33 Ω
- R4 : 10 kΩ
- R5 : 10 kΩ

- C1 : 0.022 μF Ceramic
- C2 : 0.022 μF Ceramic
- C3 : 0.022 μF Ceramic
- C4 : 0.022 μF Ceramic
- C5 : 47 μF Chemical
- C6 : 0.022 μF Ceramic
- C7 : 0.01 μF Ceramic
- C8 : 0.022 μF Ceramic
- C9 : 22 μF Chemical
- C10 : 10 μF Chemical
- C11 : 10 μF Chemical
- C12 : 0.022 μF Ceramic
- C13 : 33 μF Chemical
- C14 : 0.022 μF Ceramic
- C15 : 2.2 μF Chemical
- C16 : 0.022 μF Ceramic

- VR : 1 kΩ MAX.
- OSC COIL : RWR-43208N
- IF1 : CFT-455B
- IF2 : RMC-43198C
- ANT.CO. : AR12 φ-120
- Air vari. con. : FB621U
- Signal meter : 500 μA MAX.

TURN ON-OFF POPS LEVEL

μ PC1243C

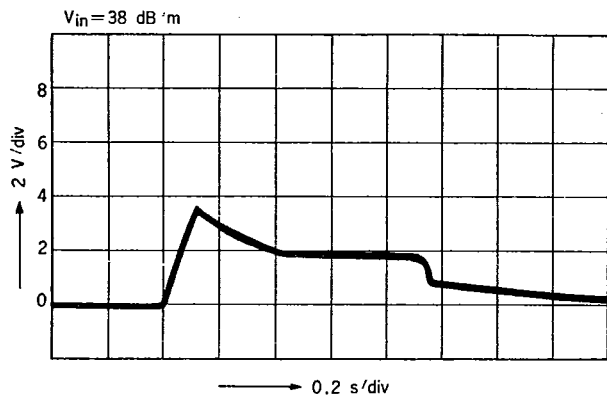

NEC's conventional circuit
(μ PC1168C)

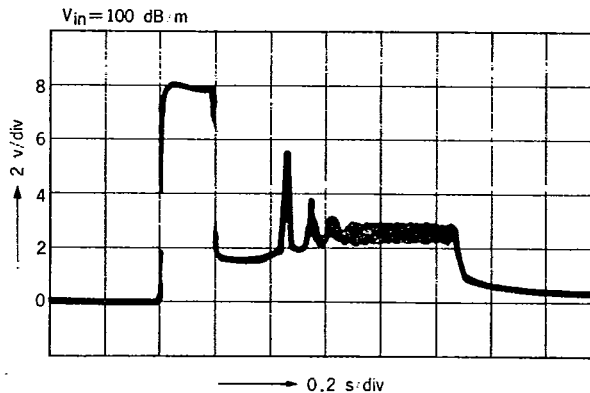
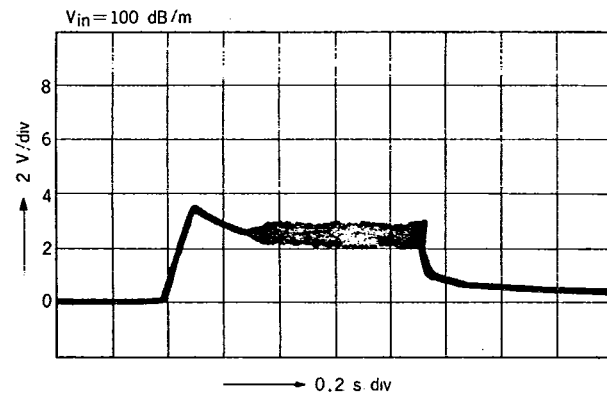
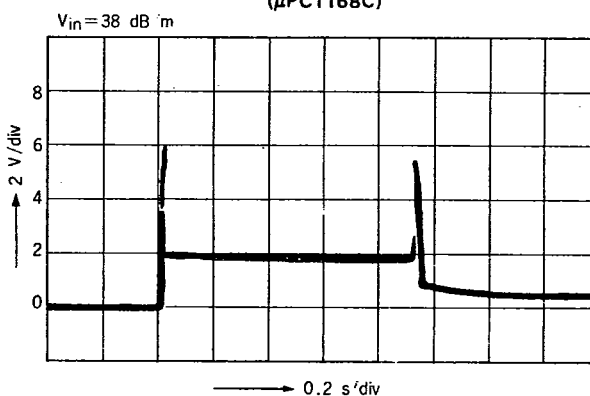

TYPICAL CHARACTERISTICS ($T_a = 25^\circ\text{C}$)

DETECTOR OUTPUT VOLTAGE AND SIGNAL TO NOISE RATIO vs. INPUT SIGNAL

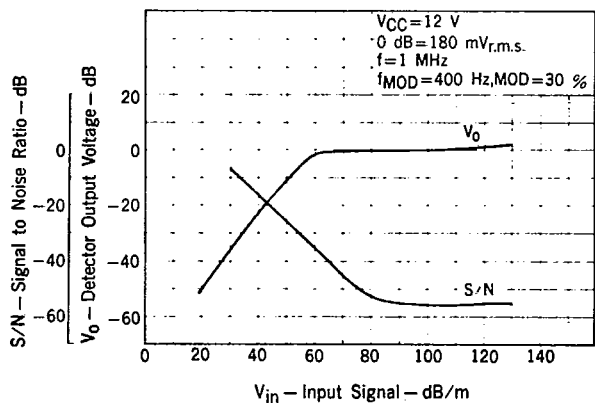

TOTAL HARMONIC DISTORTION vs. INPUT SIGNAL

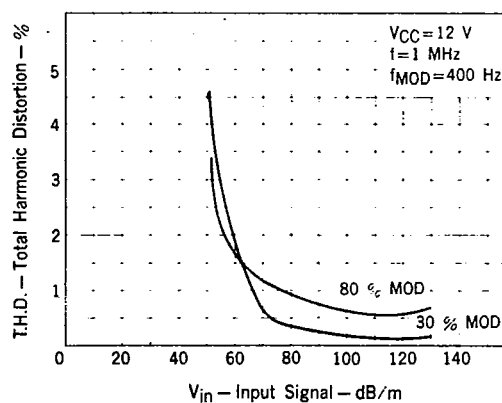

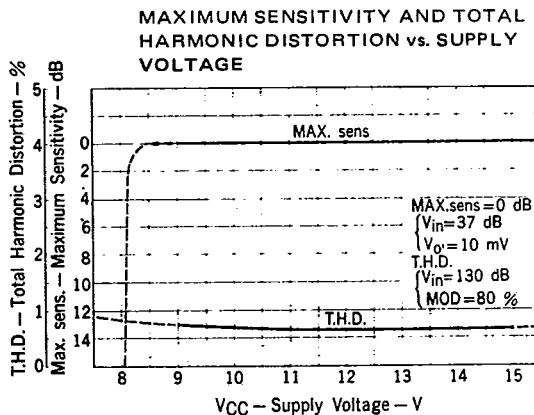
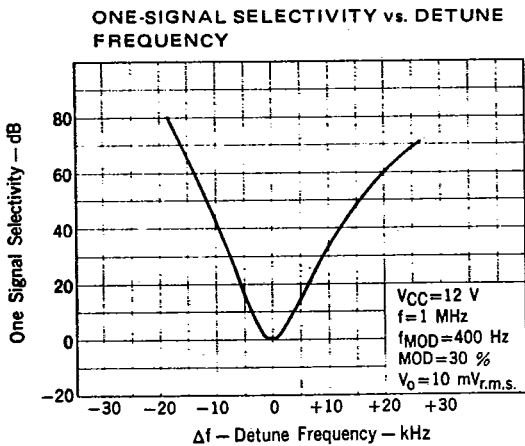
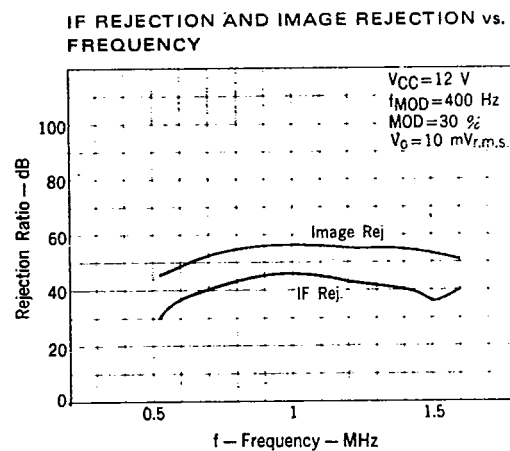
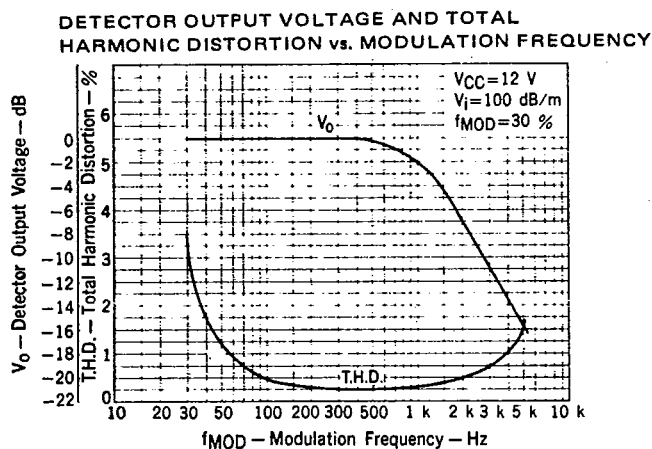
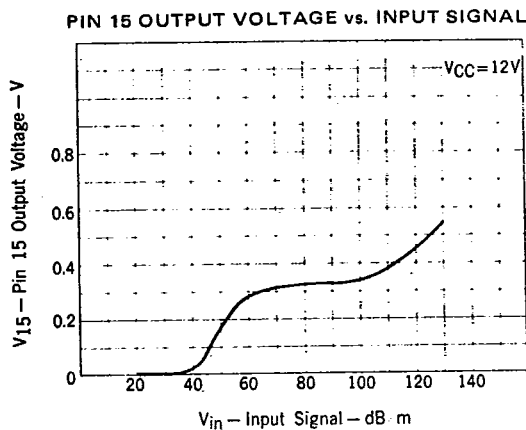
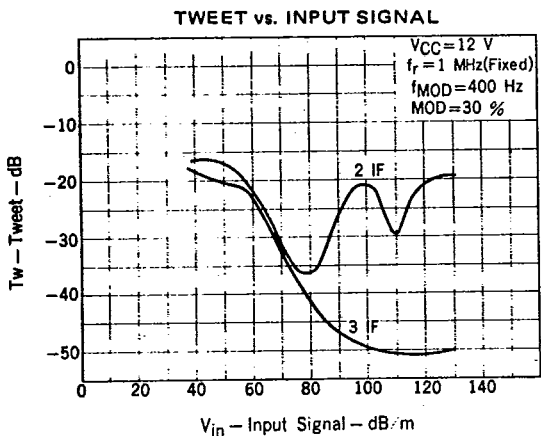

NEC ELECTRON DEVICE

N E C ELECTRONICS INC 72 DE
6427525 N E C ELECTRONICS INC

6427525 0008607 0

72C 08607

DT-77-05-05

μ PC1243C

CIRCUIT CURRENT vs. SUPPLY VOLTAGE

