

T-79-31

HIGH PERFORMANCE DUAL OPERATIONAL AMPLIFIER

- SINGLE OR SPLIT SUPPLY OPERATION
- LOW POWER CONSUMPTION
- SHORT CIRCUIT PROTECTION
- LOW DISTORTION, LOW NOISE
- HIGH GAIN-BANDWIDTH PRODUCT
- HIGH CHANNEL SEPARATION

DESCRIPTION

The LS204 is a high performance dual operational amplifier with frequency and phase compensation built into the chip. The internal phase compensation allows stable operation as voltage follower in spite of its high gain-bandwidth products.

The circuit presents very stable electrical characteristics over the entire supply voltage range, and it particularly intended for professional and telecom applications (active filters, etc).

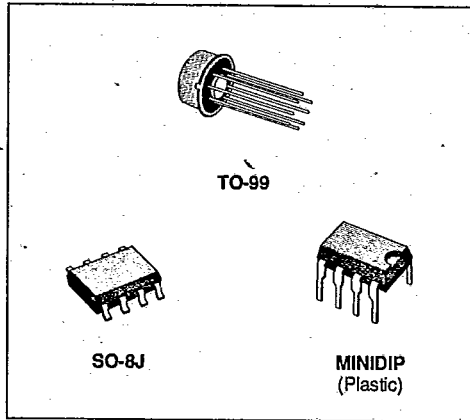

PIN CONNECTIONS (top views)

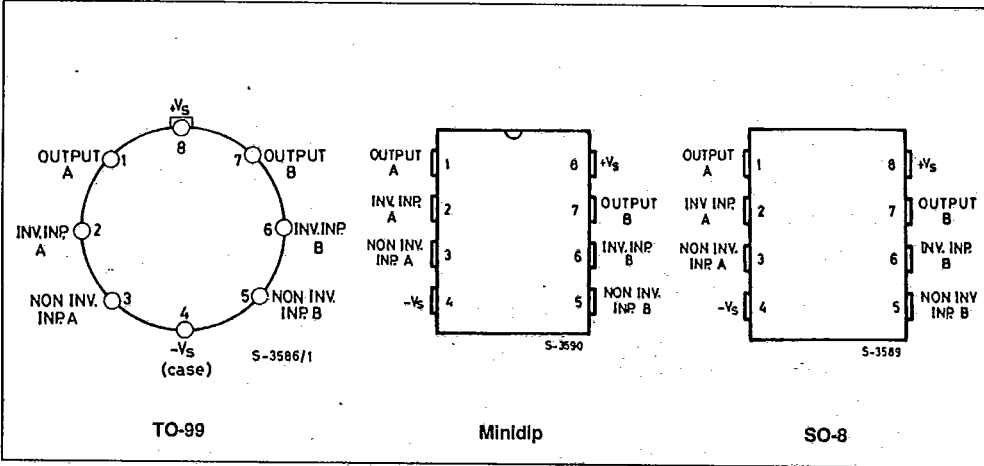

ORDER CODES

Type	TO-99	Mindip	SO-8
LS204	LS204TB	-	LS204M
LS204A	LS204ATB	-	-
LS204C	LS204CTB	LS204CB	LS204CM

SCHEMATIC DIAGRAM

SGS-THOMSON

T-79-31

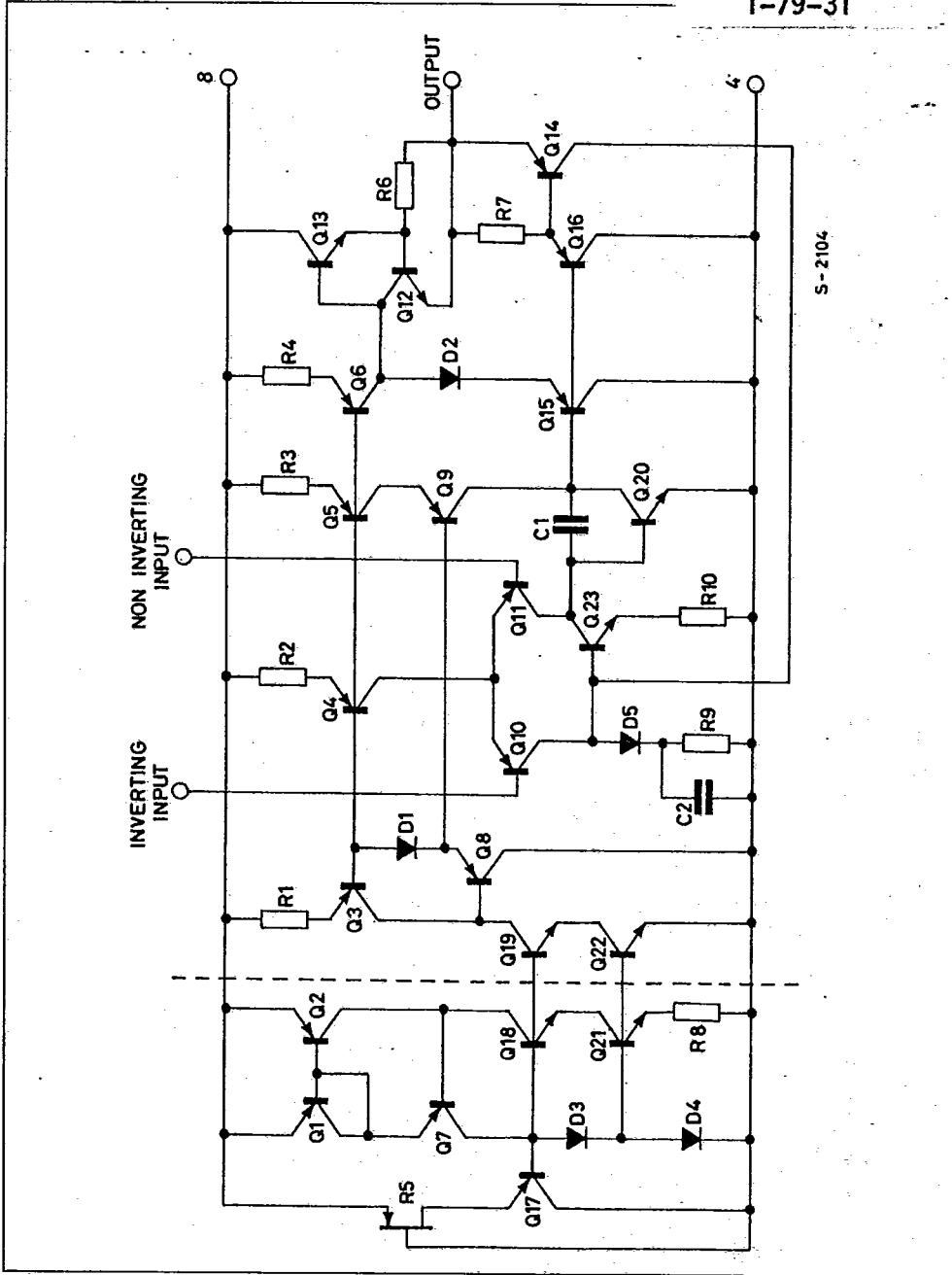

S-2104

S G S-THOMSON T-79-31

ABSOLUTE MAXIMUM RATINGS

Symbol	Parameter	TO-99	Minidip	μ Package
V_s	Supply Voltage		$\pm 18V$	
V_i	Input Voltage		$\pm V_s$	
V_i	Differential Input Voltage		$\pm (V_s - 1)$	
T_{op}	Operating Temperature for LS204 LS204A LS204C		- 25 to 85°C - 55 to 125°C 0 to 70°C	
P_{tot}	Power Dissipation at $T_{amb} = 70^\circ C$	520mW	665mW	400mW
T_j	Junction Temperature	150°C	150°C	150°C
T_{stg}	Storage Temperature	- 65 to 150°C	- 55 to 150°C	- 55 to 150°C

THERMAL DATA

R_{th-amb}	Thermal Resistance Junction-ambient	Max	TO-99	Minidip	SO-8J
			155°C/W	120°C/W	200°C/W

ELECTRICAL CHARACTERISTICS ($V_s = \pm 15V$, $T_{amb} = 25^\circ C$, unless otherwise specified)

Symbol	Parameter	Test Conditions	LS204/LS204A			LS204C			Unit	
			Min.	Typ.	Max.	Min.	Typ.	Max.		
I_s	Supply Current			0.7	1.2		0.8	1.5	mA	
I_b	Input Bias Current			50	150		100	300	nA	
		$T_{min} < T_{op} < T_{max}$			300			700	nA	
R_i	Input Resistance	$f = 1KHz$		1			0.5		M Ω	
V_{os}	Input Offset Voltage	$R_g \leq 10K\Omega$		0.5	2.5		0.5	3.5	mV	
		$R_g \leq 10K\Omega$ $T_{min} < T_{op} < T_{max}$			3.5			5	mV	
$\frac{\Delta V_{os}}{\Delta T}$	Input Offset Voltage Drift	$R_g = 10K\Omega$ $T_{min} < T_{op} < T_{max}$		5			5		$\mu V/^\circ C$	
I_{os}	Input Offset Current			5	20		12	50	nA	
		$T_{min} < T_{op} < T_{max}$			40			100	nA	
$\frac{\Delta I_{os}}{\Delta T}$	Input Offset Current Drift	$T_{min} < T_{op} < T_{max}$		0.08			0.1		$\frac{nA}{^\circ C}$	
I_{sc}	Output Short Circuit Current			23			23		mA	
G_v	Large Signal Open Loop Voltage Gain	$T_{min} < T_{op} < T_{max}$ $R_L = 2K\Omega$ $V_s = \pm 15V$ $V_s = \pm 4V$	90	100	95	86	100	95	dB	
B	Gain-bandwidth Product	$f = 20KHz$	1.8	3		1.5	2.5		MHz	
e_N	Total Input Noise Voltage	$f = 1KHz$ $R_g = 50\Omega$ $R_g = 1K\Omega$ $R_g = 10K\Omega$		8	15		10	12	20	$\frac{nV}{\sqrt{Hz}}$

ELECTRICAL CHARACTERISTICS (continued)

Symbol	Parameter	Test Conditions	LS204/LS204A			LS204C			Unit
			Min.	Typ.	Max.	Min.	Typ.	Max.	
d	Distortion	$G_v = 20dB$ $R_L = 2K\Omega$ $V_o = 2V_{PP}$ $f = 1KHZ$		0.03	0.1		0.03	0.1	%
V_o	DC Output Voltage Swing	$R_L = 2K\Omega$ $V_s = \pm 15V$ $V_s = \pm 4V$	± 13	± 3		± 13	± 3		V
V_o	Large Signal Voltage Swing	$R_L = 10K\Omega$ $f = 10KHz$		28			28		V_{PP}
SR	Slew Rate	Unity Gain $R_L = 2K\Omega$	0.8	1.5			1		V/ μs
CMR	Common Mode Rejection	$V_i = 10V$ $T_{min} < T_{op} < T_{max}$	90			86			dB
SVR	Supply Voltage Rejection	$V_i = 1V$ $f = 100Hz$ $T_{min} < T_{op} < T_{max}$	90			86			dB
CS	Channel Separation	$f = 1KHz$ 100	120			120			dB

Note :

Temp.	LS204	LS204A	LS204C
$T_{min.}$	- 25°C	- 55°C	0°C
$T_{max.}$	+ 85°C	+ 125°C	+ 70°C

Figure 1: Supply Current vs. Supply Voltage.

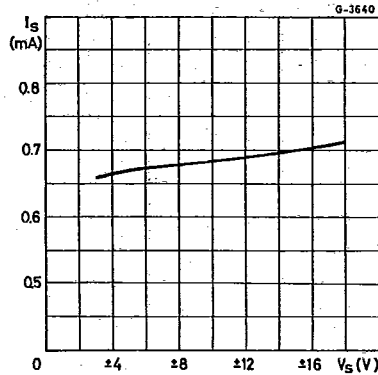

Figure 2 : Supply Current vs. Ambient Temperature.

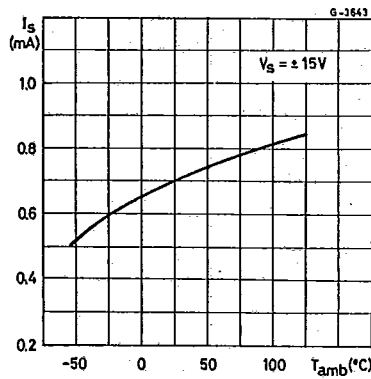

Figure 3 : Output Short Circuit Current vs. Ambient Temperature.

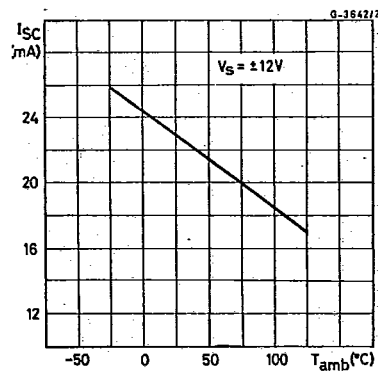

Figure 4: Open Loop Frequency and Phase Response.

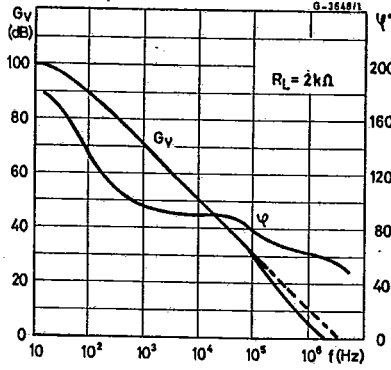

Figure 5: Open Loop Gain vs. Ambient Temperature.

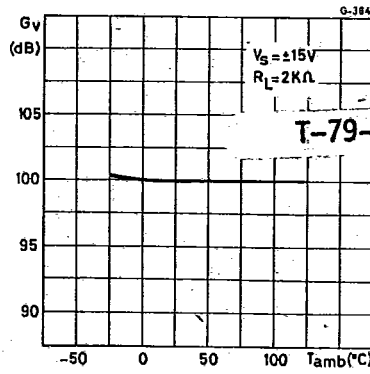

Figure 6: Supply Voltage Rejection vs. Frequency.

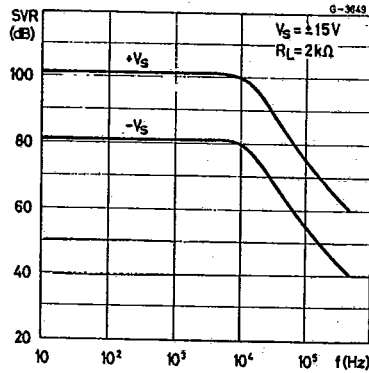

Figure 7: Large Signal Frequency Response.

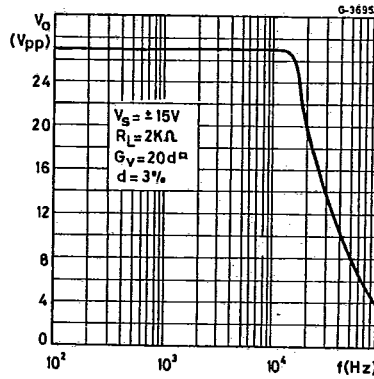

Figure 8: Output Voltage Swing vs. Load Resistance.

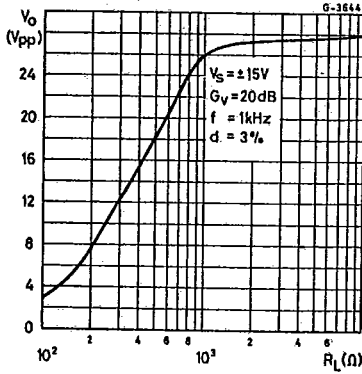
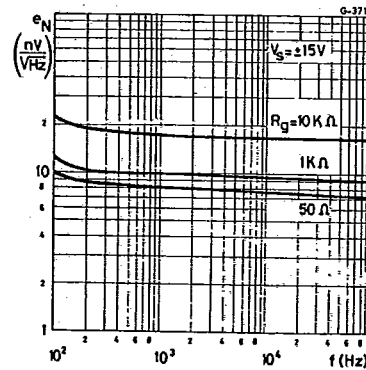

Figure 9: Total Input Noise vs. Frequency.



APPLICATION INFORMATION

Active low-pass filter :

BUTTERWORTH

The Butterworth is a "maximally flat" amplitude response filter. Butterworth filters are used for filtering signals in data acquisition systems to prevent aliasing errors in sampled-data applications and for general purpose low-pass filtering.

The cutoff frequency, f_c , is the frequency at which the amplitude response is down 3 dB. The attenuation rate beyond the cutoff frequency is $n6$ dB per octave of frequency where n is the order (number of poles) of the filter.

Other characteristics :

- Flattest possible amplitude response.
- Excellent gain accuracy at low frequency end of passband.

Figure 10 : Amplitude Response.

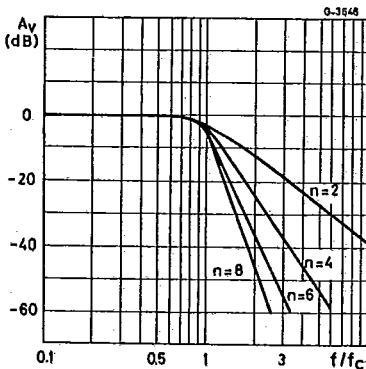

BESSEL

The Bessel is a type of "linear phase" filter. Because of their linear phase characteristics, these filters approximate a constant time delay over a limited frequency range. Bessel filters pass transient waveforms with a minimum of distortion. They are also used to provide time delays for low pass filtering of modulated waveforms and as a "running average" type filter.

The maximum phase shift is $-\frac{n\pi}{2}$ radians where n is the order (number of poles) of the filter. The cutoff frequency, f_c , is defined as the frequency at which the phase shift is one half of this value. For accurate delay, the cutoff frequency should be twice the maxi-

imum signal frequency. The following table can be used to obtain the -3 dB frequency of the filter

	2 pole	4 Pole	6 Pole	8 Pole
-3 dB Frequency	$0.77 f_c$	$0.67 f_c$	$0.57 f_c$	$0.50 f_c$

Other characteristics :

- Selectivity not as great as Chebyshev or Butterworth.
- Very little overshoot response to step inputs.
- Fast rise time.

Figure 11 : Amplitude Response.

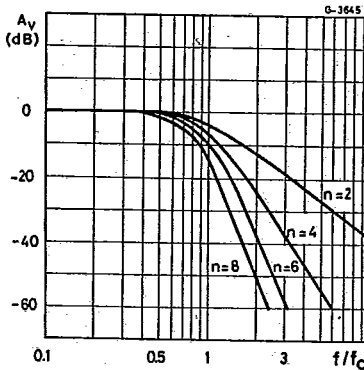

CHEBYSCHEV

Chebyshev filters have greater selectivity than either Bessel or Butterworth at the expense of ripple in the passband.

Figure 12 : Amplitude Response (± 1 dB ripple).

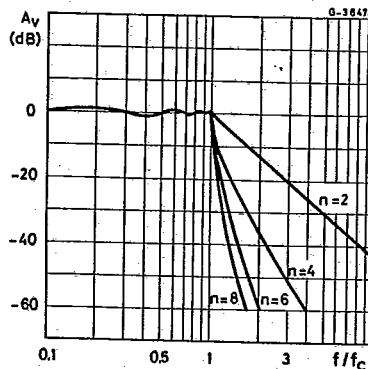

APPLICATION INFORMATION (continued)

S G S - THOMSON

Chebyshev filters are normally designed with peak-to-peak ripple values from 0.2 dB to 2 dB.

specified maximum ripple band and enters the stop band.

Increased ripple in the passband allows increased attenuation above the cutoff frequency.

Other characteristics : **T-79-31**

The cutoff frequency is defined as the frequency at which the amplitude response passes through the

- Greater selectivity
- Very nonlinear phase response
- High overshoot response to step inputs

The table below shows the typical overshoot and settling time response of the low pass filters to a step input.

	Number of Poles	Peak Overshoot	Settling Time (% of final value)		
		% Overshoot	± 1%	± 0.1%	± 0.01%
Butterworth	2	4	1.1/f _c sec.	1.7/f _c sec.	1.9/f _c sec.
	4	11	1.7/f _c	2.8/f _c	3.8/f _c
	6	14	2.4/f _c	3.9/f _c	5.0/f _c
	8	16	3.1/f _c	5.1/f _c	7.1/f _c
Bessel	2	0.4	0.8/f _c	1.4/f _c	1.7/f _c
	4	0.8	1.0/f _c	1.8/f _c	2.4/f _c
	6	0.6	1.3/f _c	2.1/f _c	2.7/f _c
	8	0.3	1.6/f _c	2.3/f _c	3.2/f _c
Chebyshev (ripple ± 0.25dB)	2	11	1.1/f _c	1.6/f _c	-
	4	18	3.0/f _c	5.4/f _c	-
	6	21	5.9/f _c	10.4/f _c	-
	8	23	8.4/f _c	16.4/f _c	-
Chebyshev (ripple ± 1dB)	2	21	1.6/f _c	2.7/f _c	-
	4	28	4.8/f _c	8.4/f _c	-
	6	32	8.2/f _c	16.3/f _c	-
	8	34	11.6/f _c	24.8/f _c	-

Design of 2nd order active low pass filter (Sallen and Key configuration unity gain-op-amp).

Figure 13 : Filter Configuration.

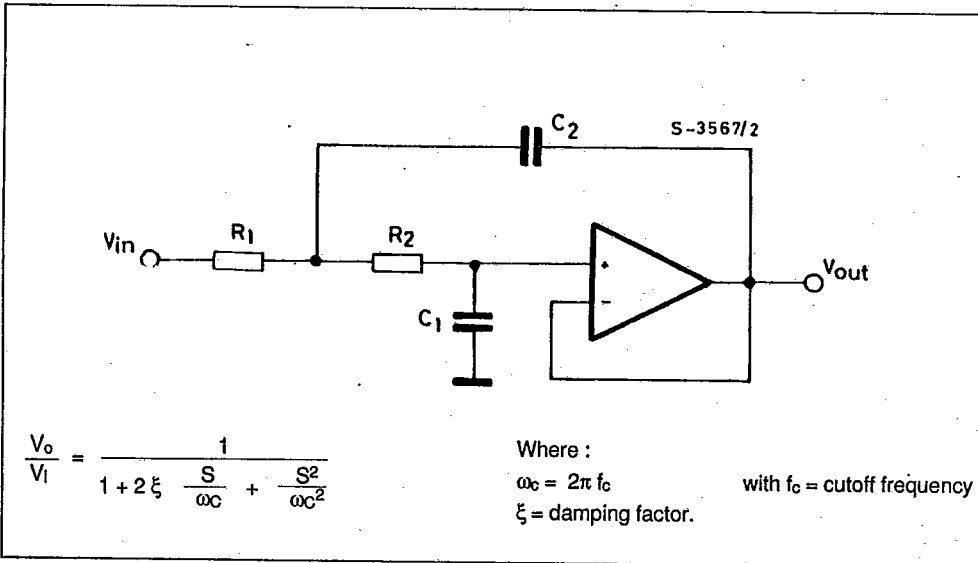

APPLICATION INFORMATION (continued)

Three parameters are needed to characterise the frequency and phase response of a 2nd order active filter : the gain (G_v), the damping factor (ξ) or the Q-factor ($Q = 2/\xi$), and the cutoff frequency (f_c). The higher order responses are obtained with a se-

ries of 2nd order sections. A simple RC section is introduced when an odd filter is required.

The choice of ' ξ ' (or Q-factor) determines the filter response (see table).

T-79-31

Table 1.

Filter Response	ξ	Q	Cutoff Frequency f_c
Bessel	$\frac{\sqrt{3}}{2}$	$\frac{1}{\sqrt{3}}$	Frequency at which Phase Shift is -90°
Butterworth	$\frac{\sqrt{2}}{2}$	$\frac{1}{\sqrt{2}}$	Frequency at Which $G_v = -3\text{dB}$
Chebyshev	$< \frac{\sqrt{2}}{2}$	$> \frac{1}{\sqrt{2}}$	Frequency at which the amplitude response passes through specified max. ripple band and enters the stop band.

Figure 14 : Filter Response vs. Damping Factor.

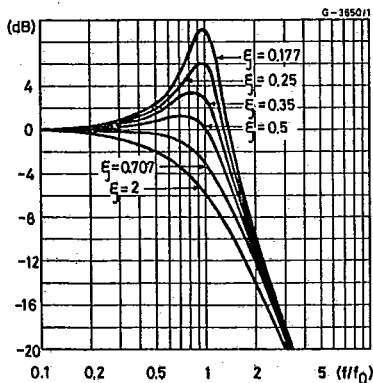

Fixed $R = R_1 = R_2$, we have (see fig. 13)

$$C_1 = \frac{1}{R} \frac{\xi}{\omega_c}$$

$$C_2 = \frac{1}{R} \frac{1}{\xi \omega_c}$$

The diagram of fig.14 shows the amplitude response for different values of damping factor ξ in

EXAMPLE

Figure 15 : 5th Order Low Pass Filter (Butterworth) with Unity Gain Configuration.

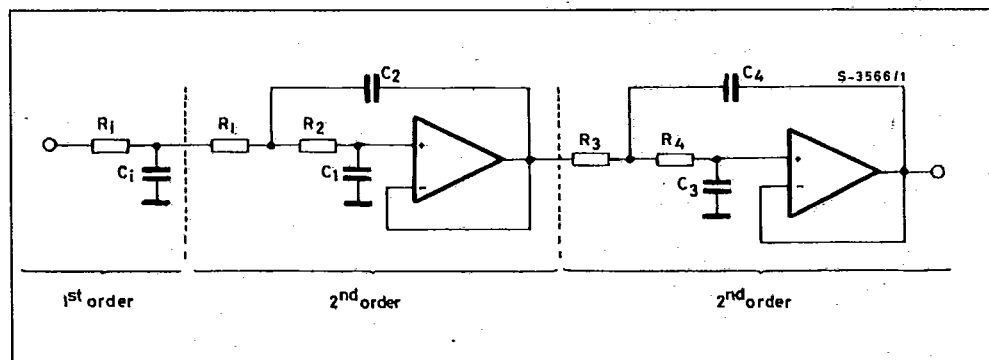

APPLICATION INFORMATION (continued)

In the circuit of fig. 15, for $f_c = 3.4$ KHz and $R_1 = R_2 = R_3 = R_4 = 10$ K Ω , we obtain :

$$C_1 = 1.354 \cdot \frac{1}{R} \cdot \frac{1}{2\pi f_c} = 6.33\text{nF}$$

$$C_1 = 0.421 \cdot \frac{1}{R} \cdot \frac{1}{2\pi f_c} = 1.97\text{nF}$$

$$C_2 = 1.753 \cdot \frac{1}{R} \cdot \frac{1}{2\pi f_c} = 8.20\text{nF}$$

$$C_3 = 0.309 \cdot \frac{1}{R} \cdot \frac{1}{2\pi f_c} = 1.45\text{nF}$$

$$C_4 = 3.325 \cdot \frac{1}{R} \cdot \frac{1}{2\pi f_c} = 15.14\text{nF}$$

The attenuation of the filter is 30 dB at 6.8 KHz and better than 60 dB at 15 KHz.

The same method, referring to Tab. II and fig. 16, is used to design high-pass filter. In this case the damping factor is found by taking the reciprocal of the numbers in Tab. II. For $f_c = 5$ KHz and $C_1 = C_1 = C_2 = C_3 = C_4 = 1$ nF we obtain :

$$R_1 = \frac{1}{1.354} \cdot \frac{1}{C} \cdot \frac{1}{2\pi f_c} = 23.5\text{K}\Omega$$

$$R_1 = \frac{1}{0.421} \cdot \frac{1}{C} \cdot \frac{1}{2\pi f_c} = 75.6\text{K}\Omega$$

$$R_2 = \frac{1}{1.753} \cdot \frac{1}{C} \cdot \frac{1}{2\pi f_c} = 18.2\text{K}\Omega$$

$$R_3 = \frac{1}{0.309} \cdot \frac{1}{C} \cdot \frac{1}{2\pi f_c} = 103\text{K}\Omega$$

$$R_4 = \frac{1}{3.325} \cdot \frac{1}{C} \cdot \frac{1}{2\pi f_c} = 9.6\text{K}\Omega$$

Table 2 : Damping Factor for Low-pass Butterworth Filters.

Order	C ₁	C ₁	C ₂	C ₃	C ₄	C ₅	C ₆	C ₇	C ₈
2		0.707	1.41						
3	1.392	0.202	3.54						
4		0.92	1.08	0.38	2.61				
5	1.354	0.421	1.75	0.309	3.235				
6		0.966	1.035	0.707	1.414	0.259	3.86		
7	1.336	0.488	1.53	0.623	1.604	0.222	4.49		
8		0.98	1.02	0.83	1.20	0.556	1.80	0.195	5.125

Figure 16 : 5th Order High-pass Filter (Butterworth) with Unity Gain Configuration.

