

FUJITSU

MOS 65536-BIT DYNAMIC RANDOM ACCESS MEMORY

MB 8264A-10
MB 8264A-12
MB 8264A-15

65,536-BIT DYNAMIC RANDOM ACCESS MEMORY

The Fujitsu MB 8264A is a fully decoded, dynamic random access memory organized as 65,536 one-bit words. The design is optimized for high-speed, high performance applications such as mainframe memory, buffer memory, peripheral storage and environments where low power dissipation and compact layout is required.

Multiplexed row and column address inputs permit the MB 8264A to be housed in a standard 16 pin DIP and 18 pad LCC. Pin-outs conform to the JEDEC approved pin out.

The MB 8264A is fabricated using silicon gate NMOS and Fujitsu's advanced Double-Layer Polysilicon process. This process, coupled with single-transistor memory storage cells, permits maximum circuit density and minimal chip size. Dynamic circuitry is employed in the design, including the sense amplifiers.

Clock timing requirements are non-critical, and power supply tolerance is very wide. All inputs and output are TTL compatible.

- 65,536 x 1 RAM, 16 pin DIP/18 pad LCC
- Silicon-gate, Double Poly NMOS, single transistor cell
- Row access time,
 - 100 ns max (MB 8264A-10)
 - 120 ns max (MB 8264A-12)
 - 150 ns max (MB 8264A-15)
- Cycle time,
 - 190 ns min (MB 8264A-10)
 - 230 ns min (MB 8264A-12)
 - 260 ns min (MB 8264A-15)
- Single +5V Supply, $\pm 10\%$ tolerance
- Low power (active)
 - 275 mW max (MB 8264A-10)
 - 248 mW max (MB 8264A-12)
 - 220 mW max (MB 8264A-15)
 - 22 mW Standby (max)
- 2ms/128 refresh cycles
- $\overline{\text{RAS}}$ -only and Hidden refresh capability
- Read-Modify-Write and Page-Mode capability
- Common I/O capability using Early Write operation
- Output unlatched at cycle end allows extended page boundary and two-dimensional chip select
- On-chip latches for Addresses and Data-in
- t_{AR} , t_{WCR} , t_{DHR} are eliminated
- Standard 16-pin Ceramic (Cerdip) DIP: Surfix-Z
Standard 16-pin Plastic DIP: Surfix-P
Standard 18-pad Ceramic LCC: Surfix-TV

ABSOLUTE MAXIMUM RATINGS (See NOTE)

Rating	Symbol	Value	Unit
Voltage on any pin relative to V_{SS}	V_{IN}, V_{OUT}	-1 to +7	V
Voltage on V_{CC} supply relative to V_{SS}	V_{CC}	-1 to +7	V
Storage temperature	Ceramic	-55 to +150	°C
	Plastic	-55 to +125	
Power dissipation	P_D	1.0	W
Short circuit output current		50	mA

NOTE: Permanent device damage may occur if ABSOLUTE MAXIMUM RATINGS are exceeded. Functional operation should be restricted to the conditions as detailed in the operational sections of this data sheet. Exposure to absolute maximum rating conditions for extended periods may affect device reliability.

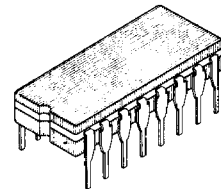

**CERAMIC PACKAGE
(CERDIP)
DIP-16C-C04**

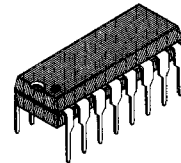

**PLASTIC PACKAGE
DIP-16P-M03**

LCC-18C-F02 : See Page 1-191

PIN ASSIGNMENT

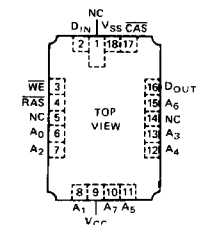
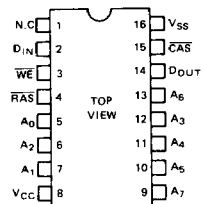

This device contains circuitry to protect the inputs against damage due to high static voltages or electric fields. However, it is advised that normal precautions be taken to avoid application of any voltage higher than maximum rated voltages to this high impedance circuit.



MB 8264A-10
MB 8264A-12
MB 8264A-15

Fig. 1 - MB 8264A BLOCK DIAGRAM

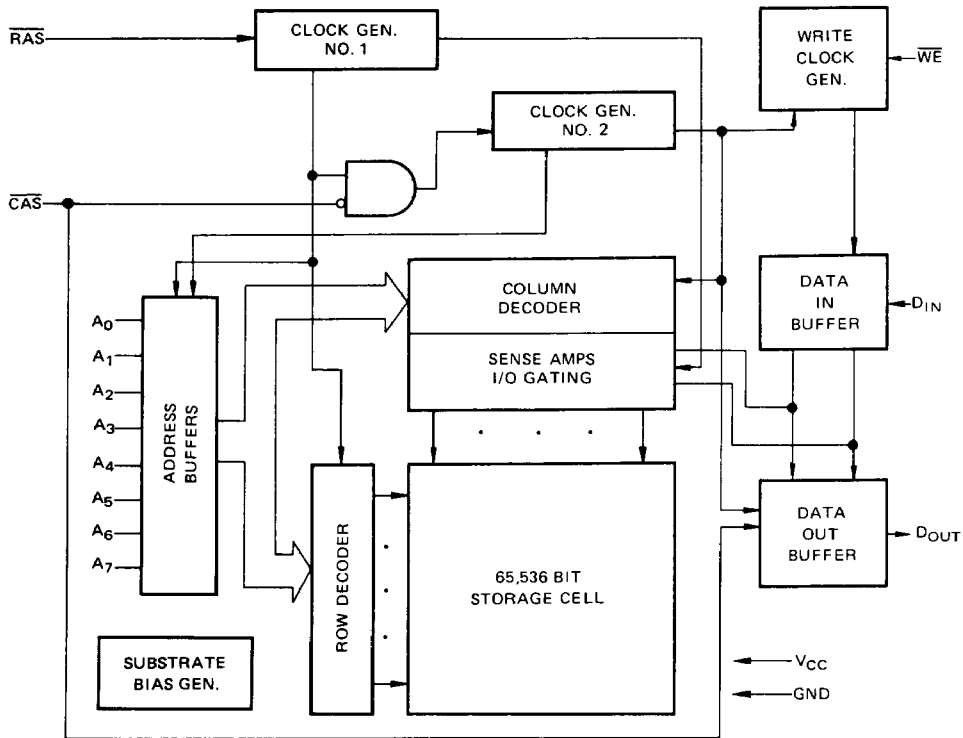

CAPACITANCE ($T_A = 25^\circ\text{C}$)

Parameter	Symbol	Typ	Max	Unit
Input Capacitance A ₀ ~A ₇ , D _{IN}	C _{IN1}		5	pF
Input Capacitance RAS, CAS, WE	C _{IN2}		8	pF
Output Capacitance D _{OUT}	C _{OUT}		7	pF

RECOMMENDED OPERATING CONDITIONS

(Referenced to V_{SS})

Parameter	Symbol	Min	Typ	Max	Unit	Operating Temperature
Supply Voltage	V_{CC}	4.5	5.0	5.5	V	0°C to +70°C
	V_{SS}	0	0	0	V	
Input High Voltage, all inputs	V_{IH}	2.4		6.5	V	
Input Low Voltage, all inputs	V_{IL}^*	-1.0		0.8	V	

Note * : The device can withstand undershoots to the -2V level with a pulse width of 20 ns.

DC CHARACTERISTICS

(Recommended operating conditions unless otherwise noted.)

Parameter	Symbol	Min	Max	Unit
OPERATING CURRENT * Average power supply current (\overline{RAS} , \overline{CAS} cycling; $t_{RC} = \text{min}$)	MB 8264A-10		50	mA
	MB 8264A-12		45	
	MB 8264A-15		40	
STANDBY CURRENT Standby Power supply current ($\overline{RAS} = \overline{CAS} = V_{IH}$)	I_{CC2}		4	mA
REFRESH CURRENT * Average power supply current ($\overline{CAS} = V_{IH}$, \overline{RAS} cycling; $t_{RC} = \text{min}$)	MB 8264A-10		38	mA
	MB 8264A-12		35	
	MB 8264A-15		31	
PAGE MODE CURRENT* Average power supply current ($\overline{RAS} = V_{IL}$, \overline{CAS} cycling; $t_{PC} = \text{min}$)	MB 8264A-10		35	mA
	MB 8264A-12		32	
	MB 8264A-15		28	
INPUT LEAKAGE CURRENT Input leakage current, any input ($0V \leq V_{IN} \leq 5.5V$, $V_{CC} = 5.5V$, $V_{SS} = 0V$, all other pins not test = 0V)	$I_{I(L)}$	-10	10	μA
OUTPUT LEAKAGE CURRENT (Data out is disabled, $0V \leq V_{OUT} \leq 5.5$)	$I_{O(L)}$	-10	10	μA
OUTPUT LEVELS Output high voltage ($I_{OH} = -5mA$) Output low voltage ($I_{OL} = 4.2mA$)	V_{OH}	2.4	0.4	V
	V_{OL}			V

Note * : I_{CC} is dependent on output loading and cycle rates. Specified values are obtained with the output open.

AC CHARACTERISTICS

(Recommended operating conditions unless otherwise noted.) **NOTES 1, 2, 3**

Parameter	NOTES	Symbol	M8 8264A-10		MB 8264A-12		MB 8264A-15		Unit
			Min	Max	Min	Max	Min	Max	
Time between Refresh		t_{REF}		2		2		2	ms
Random Read/Write Cycle Time		t_{RC}	190		230		260		ns
Read-Write Cycle Time		t_{RWC}	230		265		280		ns
Page Mode Cycle Time		t_{PC}	105		120		145		ns
Page Mode Read-Write Cycle Time		t_{PRWC}	135		155		180		ns
Access Time from \overline{RAS}	4 6	t_{RAC}		100		120		150	ns
Access Time from \overline{CAS}	5 6	t_{CAC}		50		60		75	ns
Output Buffer Turn Off Delay		t_{OFF}	0	30	0	35	0	40	ns
Transition Time		t_T	3	50	3	50	3	50	ns
RAS Precharge Tim		t_{RP}	80		100		100		ns
RAS Pulse Width		t_{RAS}	100	10000	120	10000	150	10000	ns
RAS Hold Time		t_{RSH}	50		60		75		ns
CAS Precharge Time (Page mode only)		t_{CP}	45		50		60		ns
CAS Precharge Time (All cycles except page mode)		t_{CPN}	20		20		25		ns
CAS Pulse Width		t_{CAS}	50	10000	60	10000	75	10000	ns
CAS Hold Time		t_{CSH}	100		120		150		ns
RAS to CAS Delay Tim	7 8	t_{RCD}	20	50	20	60	25	75	ns
CAS to RAS Precharge Time		t_{CRP}	0		0		0		ns
Row Address Set Up Time		t_{ASR}	0		0		0		ns
Row Address Hold Time		t_{RAH}	10		10		15		ns
Column Address Set Up Time		t_{ASC}	0		0		0		ns
Column Address Hold Time		t_{CAH}	15		15		20		ns
Read Command Set Up Time		t_{RCS}	0		0		0		ns
Read Command Hold Time Referenced to CAS 10		t_{RCH}	0		0		0		ns
Read Command Hold Time Referenced to RAS 10		t_{RRH}	20		20		20		ns
Write Command Set Up Time	9	t_{WCS}	0		0		0		ns
Write Command Hold Time		t_{WCH}	20		25		30		ns
Write Command Pulse Width		t_{WP}	20		25		30		ns
Write Command to RAS Lead Time		t_{RWL}	35		40		45		ns
Write Command to \overline{CAS} Lead Time		t_{CWL}	35		40		45		ns
Data In Set Up Time		t_{DS}	0		0		0		ns
Data In Hold Time		t_{DH}	20		25		30		ns
CAS to \overline{WE} Delay	11	t_{CWD}	40		50		60		ns
RAS to \overline{WE} Delay	11	t_{RWD}	90		110		120		ns
RAS Precharge to \overline{CAS} Hold Time (RAS-only refresh)		t_{RPC}	20		20		20		ns



Notes:

- 1 An initial pause of 200 μ s is required after power-up followed by any 8 $\overline{\text{RAS}}$ cycles before proper device operation is achieved.
- 2 AC characteristics assume $t_T = 5\text{ns}$.
- 3 V_{IH} (min) and V_{IL} (max) are reference levels for measuring timing of input signals. Also, transition times are measured between V_{IH} (min) and V_{IL} (max).
- 4 Assumes that $t_{RCD} \leq t_{RCD}(\text{max})$. If t_{RCD} is greater than the maximum recommended value shown in this table, t_{RAC} will increase by the amount that t_{RCD} exceeds the value shown.
- 5 Assumes that $t_{RCD} \geq t_{RCD}(\text{max})$.
- 6 Measured with a load equivalent to 2 TTL loads and 100 pF.
- 7 Operation within the $t_{RCD}(\text{max})$ limit insures that $t_{RAC}(\text{max})$ can be met. $t_{RCD}(\text{max})$ is specified as a

reference point only; if t_{RCD} is greater than the specified $t_{RCD}(\text{max})$ limit, then access time is controlled exclusively by t_{CAC} .

- 8 $t_{RCD}(\text{min}) = t_{RAH}(\text{min}) + 2t_T (t_T=5\text{ns}) + t_{ASC}(\text{min})$
- 9 t_{WCS} , t_{CWD} and t_{RWD} are not restrictive operating parameters. They are included in the data sheet as electrical characteristics only. If $t_{WCS} \geq t_{WCS}(\text{min})$ the cycle is an early write cycle and the data out pin will remain open circuit (high impedance) throughout entire cycle. If $t_{CWD} \geq t_{CWD}(\text{min})$ and $t_{RWD} \geq t_{RWD}(\text{min})$, the cycle is a read-write cycle and data out will contain data read from the selected cell. If neither of the above sets of conditions is satisfied the condition of the data out is indeterminate.
- 10 Either t_{RRH} or t_{RCH} must be satisfied for a read cycle.

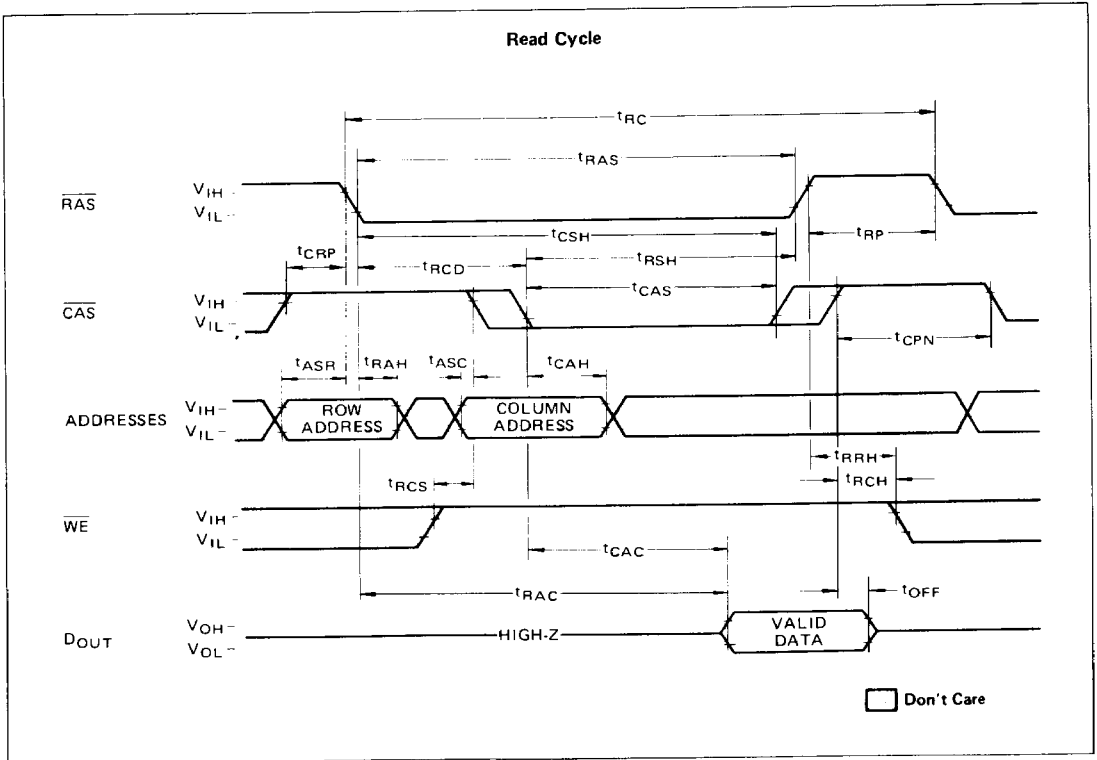

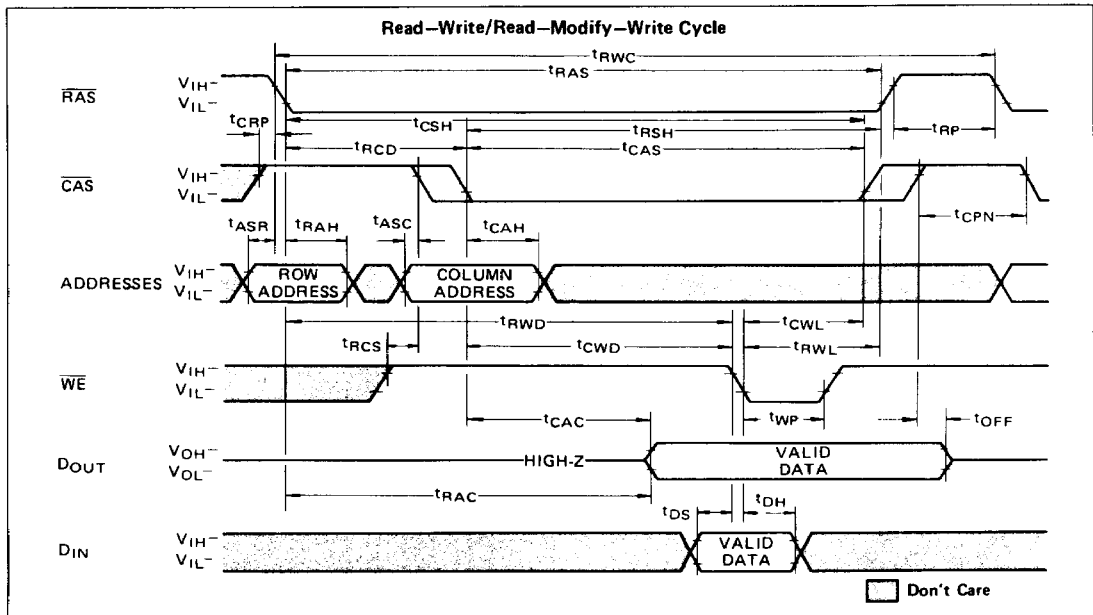
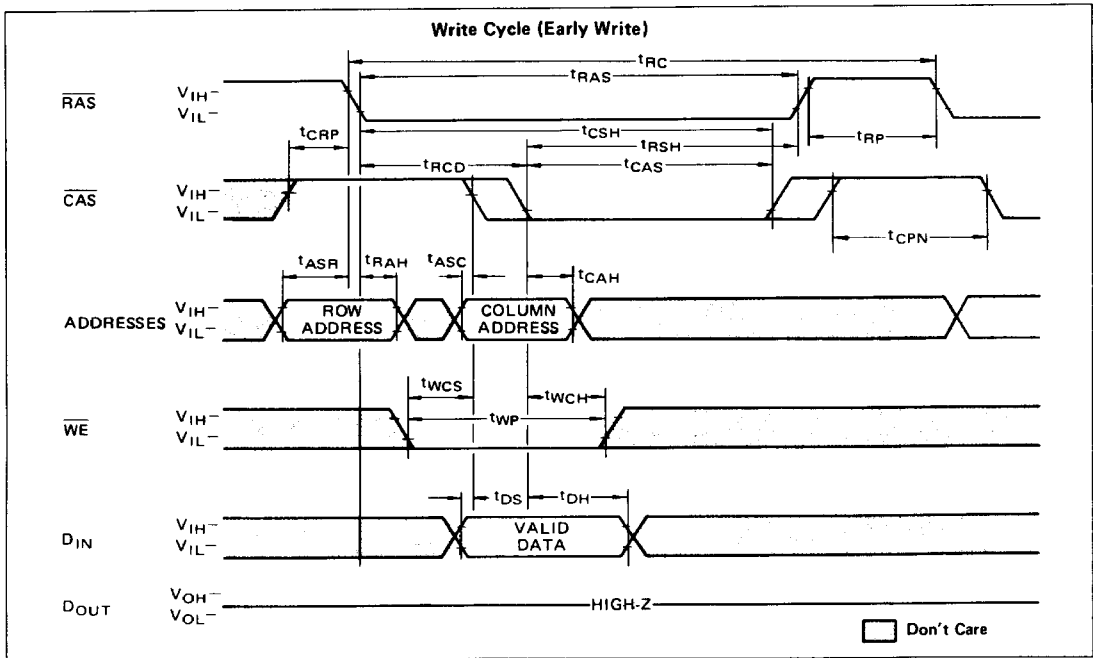

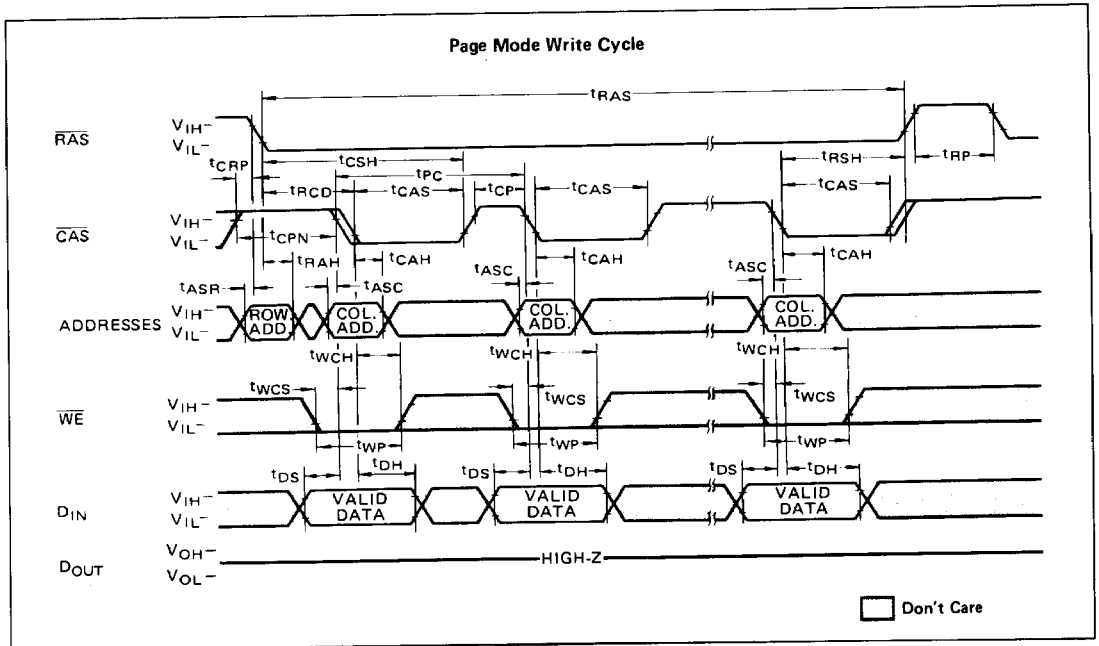
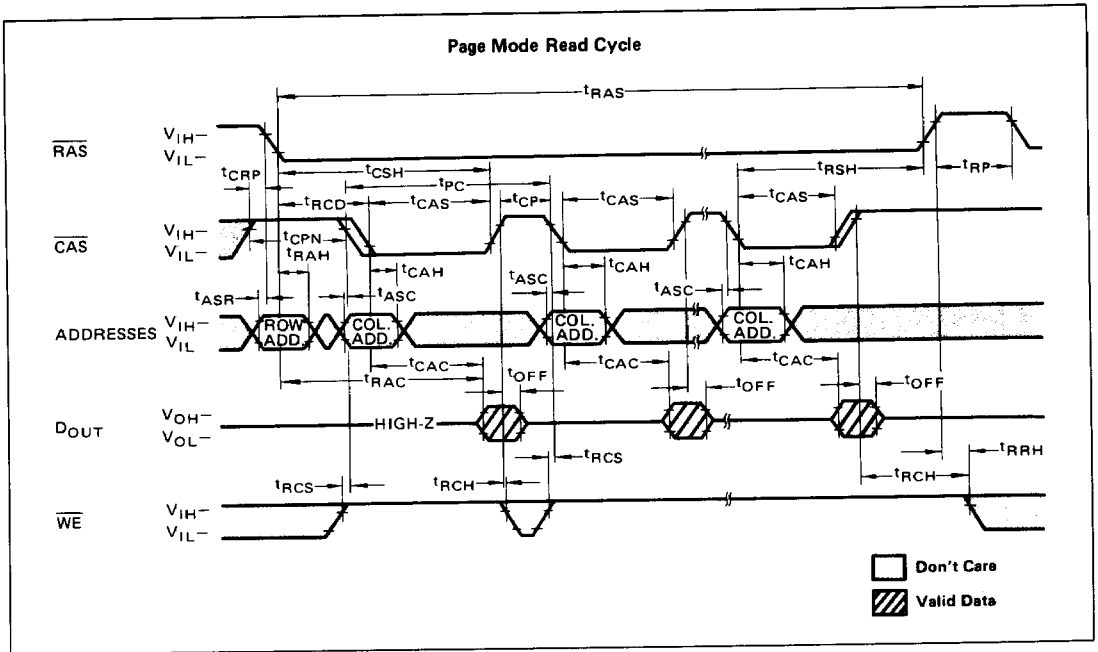

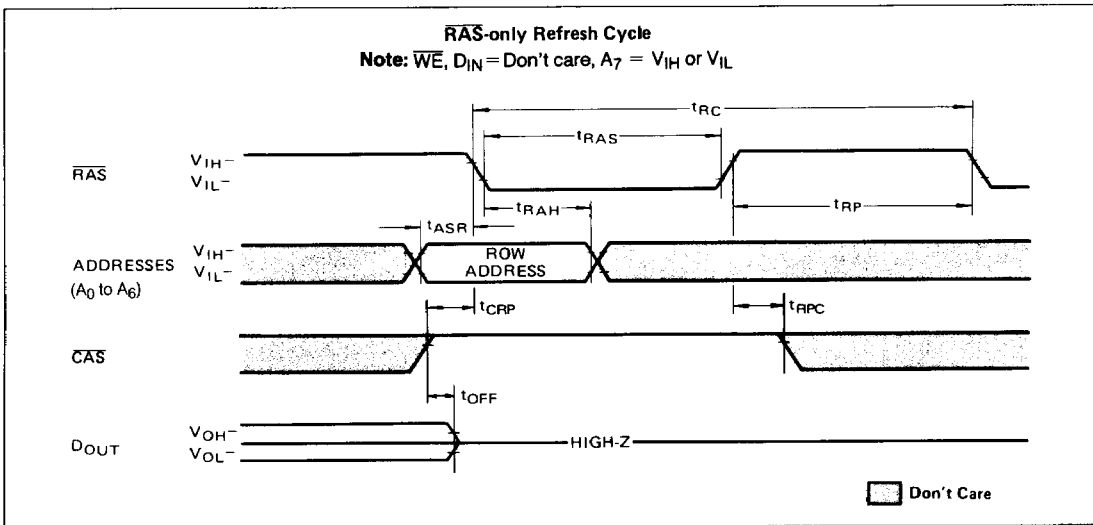
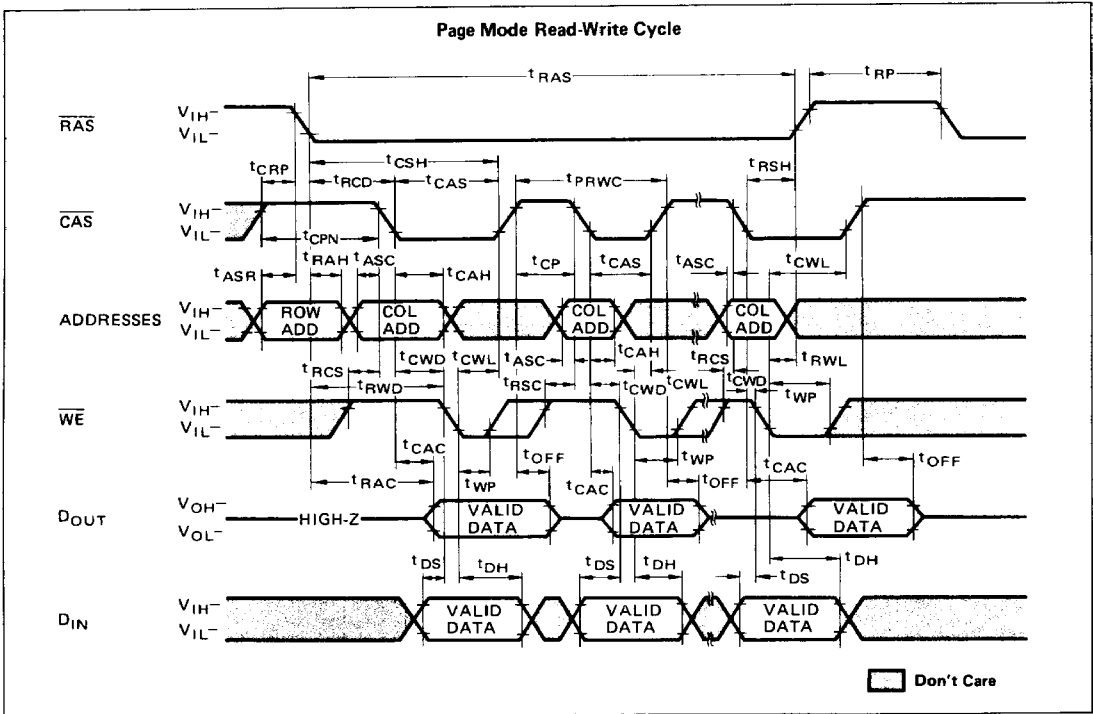

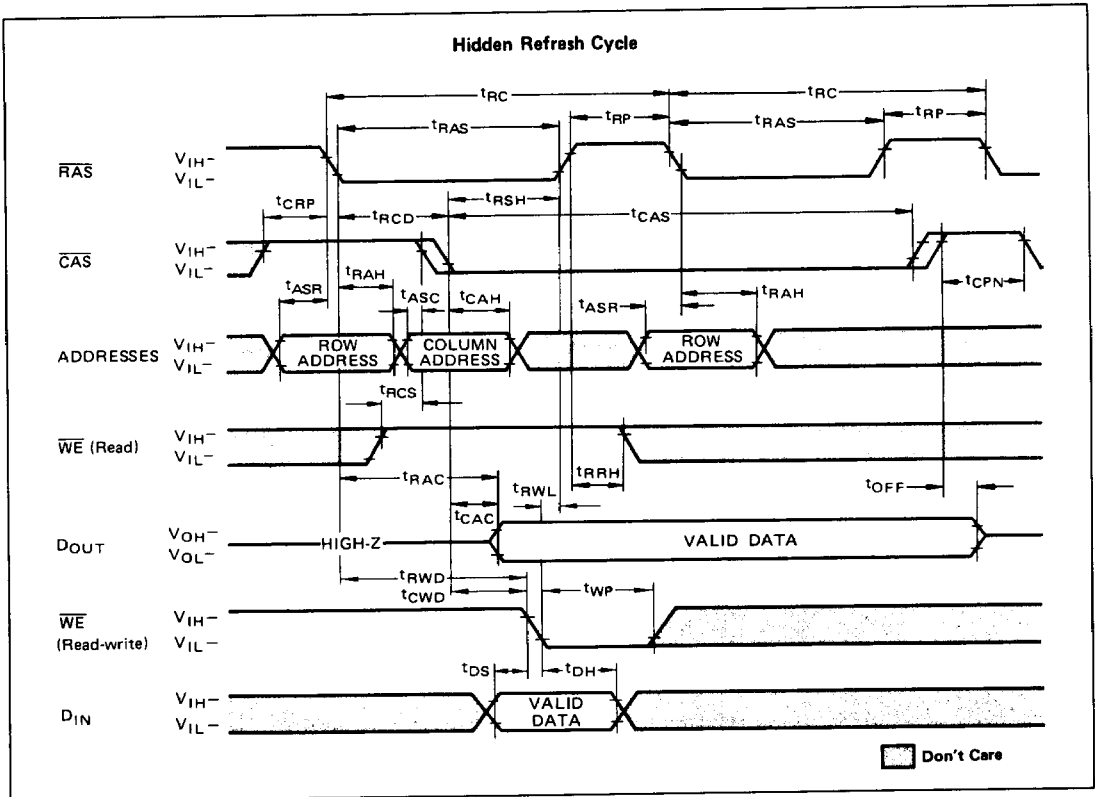

DESCRIPTION

Address Inputs:

A total of sixteen binary input address bits are required to decode any 1 of 65536 storage cell locations within the MB 8264A. Eight row-address bits are established on the input pins (A_0 through A_7) and latched with the Row Address Strobe (\overline{RAS}). The eight column-address bits are established on the input pins and latched with the Column Address Strobe (\overline{CAS}). All input addresses must be stable on or before the falling edge of \overline{RAS} . \overline{CAS} is internally inhibited (or "gated") by \overline{RAS} to permit triggering of \overline{CAS} as soon as the Row Address Hold Time

(t_{RAH}) specification has been satisfied and the address inputs have been changed from row-addresses to column-addresses.

Write Enable:

The read mode or write mode is selected with the \overline{WE} input. A high on \overline{WE} selects read mode and low selects write mode. Data input is disabled when read mode is selected.

Data Input:

Data is written into the MB 8264A during a write or read-write cycle. The later falling edge of \overline{WE} or \overline{CAS} is a strobe for

the Data In (D_{IN}) register. In a write cycle, if \overline{WE} is brought low (write mode) before \overline{CAS} , D_{IN} is strobed by \overline{CAS} , and the set-up and hold times are referenced to \overline{CAS} . In a read-write cycle, \overline{WE} can be low after \overline{CAS} has been low and \overline{CAS} to \overline{WE} Delay Time (t_{CWD}) has been satisfied. Thus D_{IN} is strobed by \overline{WE} , and set-up and hold times are referenced to \overline{WE} .

Data Output:

The output buffer is three-state TTL compatible with a fan-out of two standard TTL loads. Data-out is the same polarity as data-in. The output is in a



high impedance state until $\overline{\text{CAS}}$ is brought low. In a read cycle, or read-write cycle, the output is valid after t_{RAC} from the falling edge of $\overline{\text{RAS}}$ when t_{RCD} (max) is satisfied, or after t_{CAC} from the falling edge of $\overline{\text{CAS}}$ when the transition occurs after t_{RCD} (max). Data remains valid until $\overline{\text{CAS}}$ is returned to a high. In a write cycle the identical sequence occurs, but data is not valid.

Page Mode:

Page-mode operation permits strobing the row-address into the MB 8264A while maintaining $\overline{\text{RAS}}$ at a low throughout all successive memory oper-

ations in which the row addresses don't change. Thus the power dissipated by the falling edge of $\overline{\text{RAS}}$ is saved. Further, access and cycle times are decreased because the time normally required to strobe a new row addresses are eliminated.

$\overline{\text{RAS}}$ -only Refresh

Refresh of the dynamic memory cells is accomplished by performing a memory cycle at each of the 128 row-addresses ($A_0 \sim A_6$) at least every two milliseconds. During refresh, either V_{IL} or V_{IH} is permitted for A_7 . $\overline{\text{RAS}}$ -only refresh avoids any output during refresh

because the output buffer is in a high impedance state unless $\overline{\text{CAS}}$ is brought low. Strobing each of 128 row-addresses with $\overline{\text{RAS}}$ will cause all bits in each row to be refreshed. Further $\overline{\text{RAS}}$ -only refresh results in a substantial reduction in power dissipation.

Hidden Refresh:

$\overline{\text{RAS}}$ -only refresh cycle may take place while maintaining valid output data. This feature is referred to as Hidden Refresh.

Hidden Refresh is performed by holding $\overline{\text{CAS}}$ as V_{IL} from a previous memory read cycle.

Fig. 2 – CURRENT WAVE FORM ($V_{\text{CC}} = 5.5\text{V}$, $T_{\text{A}} = 25^\circ\text{C}$)

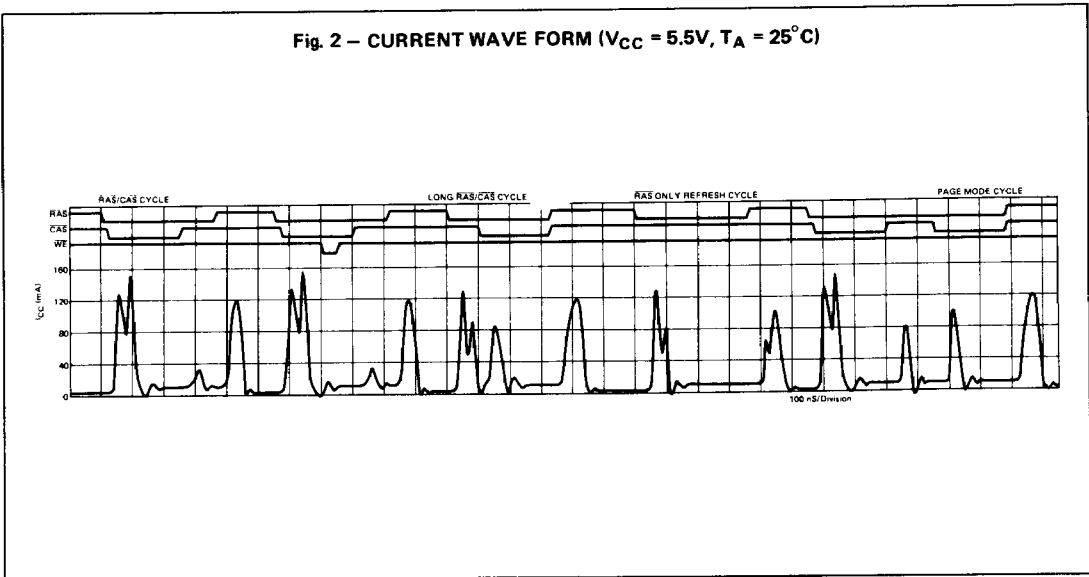

TYPICAL CHARACTERISTICS CURVES

Fig. 3 – NORMALIZED ACCESS TIME vs SUPPLY VOLTAGE

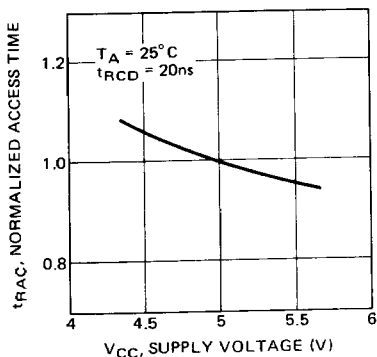

Fig. 4 – NORMALIZED ACCESS TIME vs AMBIENT TEMPERATURE

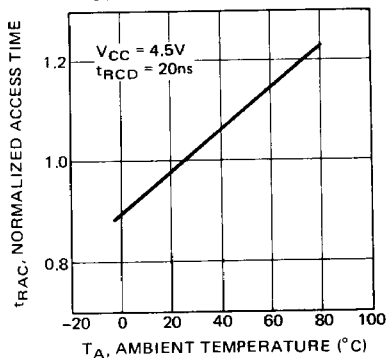

Fig. 5 – OPERATING CURRENT vs CYCLE RATE

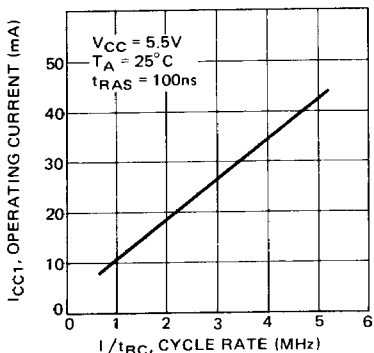

Fig. 6 – OPERATING CURRENT vs SUPPLY VOLTAGE

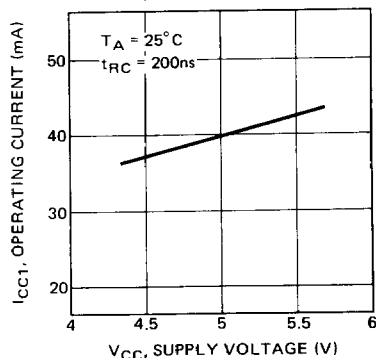

Fig. 7 – OPERATING CURRENT vs AMBIENT TEMPERATURE

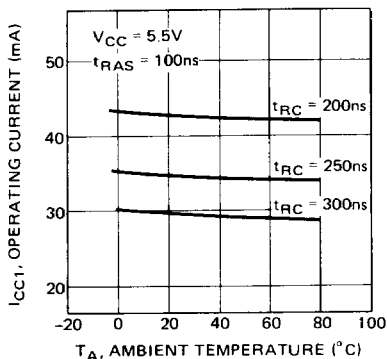

Fig. 8 – STANDBY CURRENT vs SUPPLY VOLTAGE

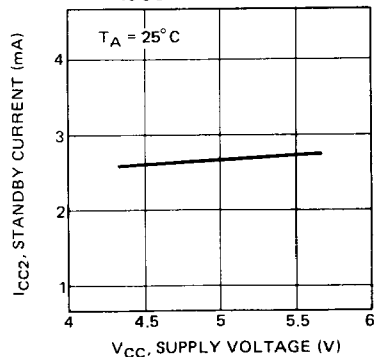



Fig. 9 – STANDBY CURRENT vs AMBIENT TEMPERATURE

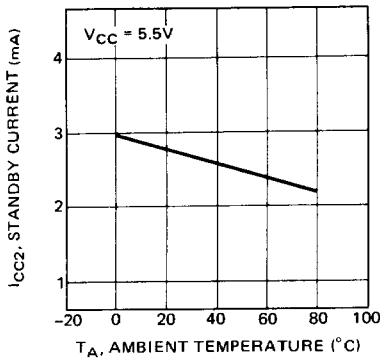

Fig. 10 – REFRESH CURRENT vs CYCLE RATE

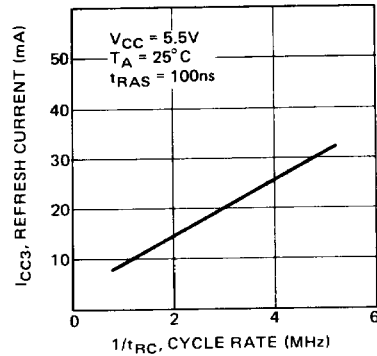

Fig. 11 – REFRESH CURRENT vs SUPPLY VOLTAGE

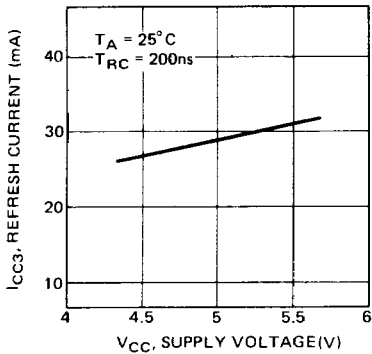

Fig. 12 – REFRESH CURRENT vs AMBIENT TEMPERATURE

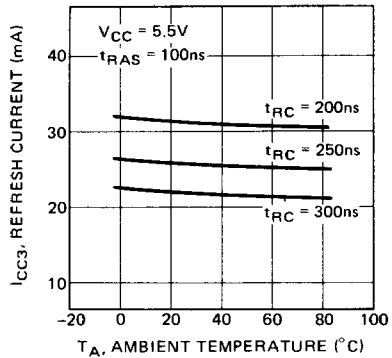

Fig. 13 – PAGE MODE CURRENT vs CYCLE RATE

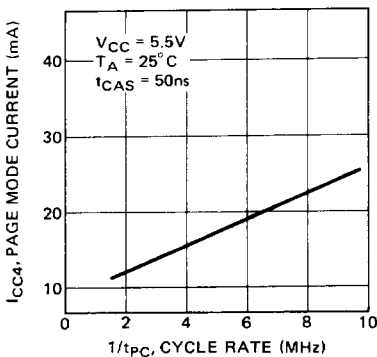

Fig. 14 – PAGE MODE CURRENT vs SUPPLY VOLTAGE

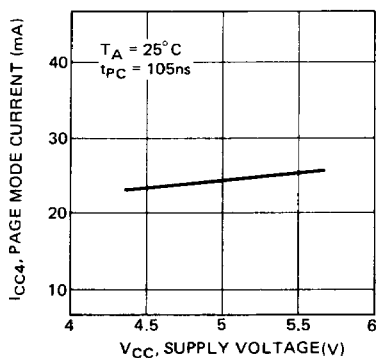

Fig. 15 – PAGE MODE CURRENT vs AMBIENT TEMPERATURE

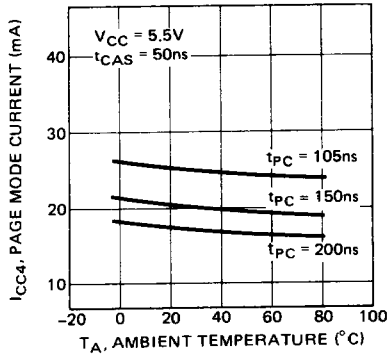

Fig. 16 – ADDRESS AND DATA INPUT VOLTAGE vs SUPPLY VOLTAGE

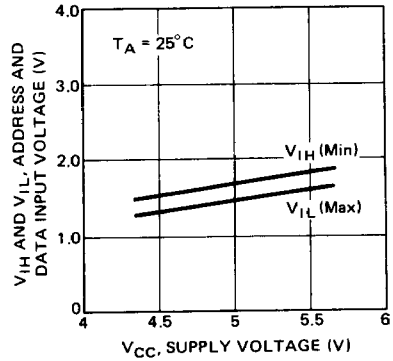

Fig. 17 – ADDRESS AND DATA INPUT VOLTAGE vs AMBIENT TEMPERATURE

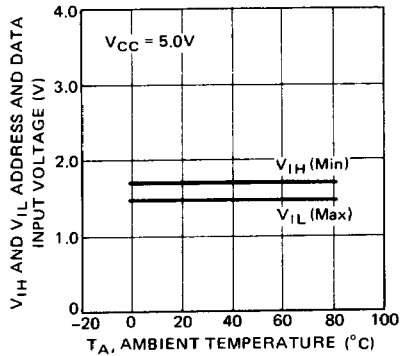

Fig. 18 – \overline{RAS} , \overline{CAS} AND \overline{WE} INPUT VOLTAGE vs SUPPLY VOLTAGE

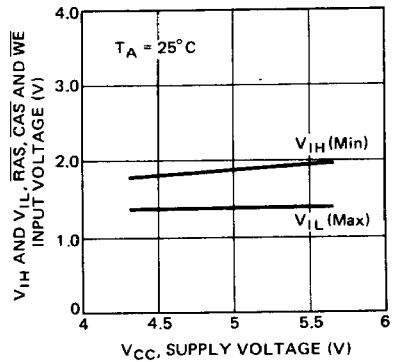

Fig. 19 – \overline{RAS} , \overline{CAS} AND \overline{WE} VOLTAGE vs AMBIENT TEMPERATURE

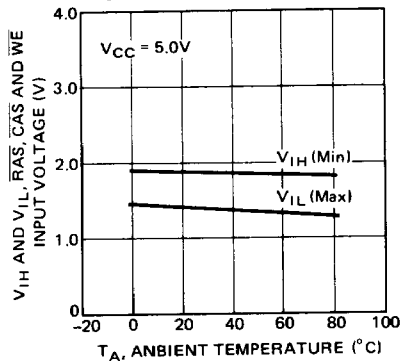



Fig. 20 – CURRENT WAVE FORM DURING POWER UP

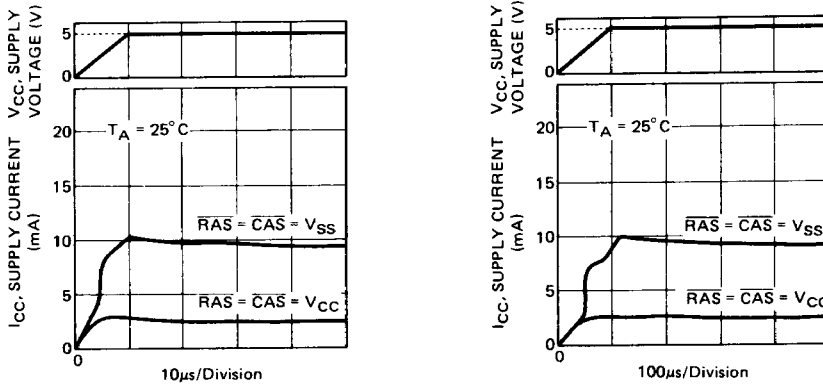

Fig. 21 – CURRENT WAVE FORM DURING POWER UP (ON MEMORY BOARD)

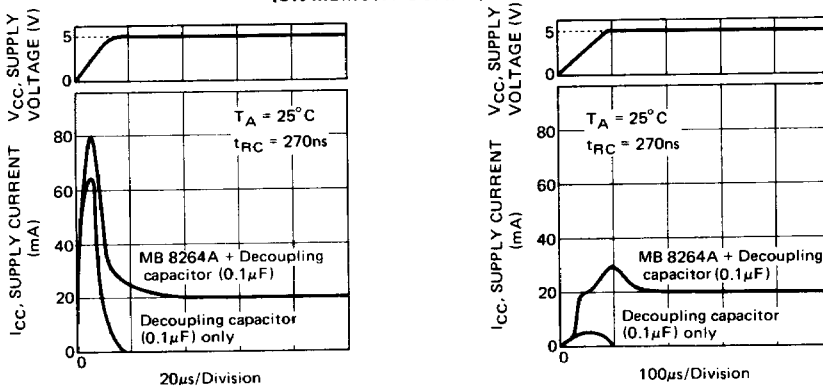
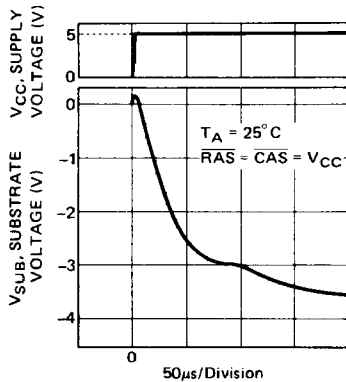
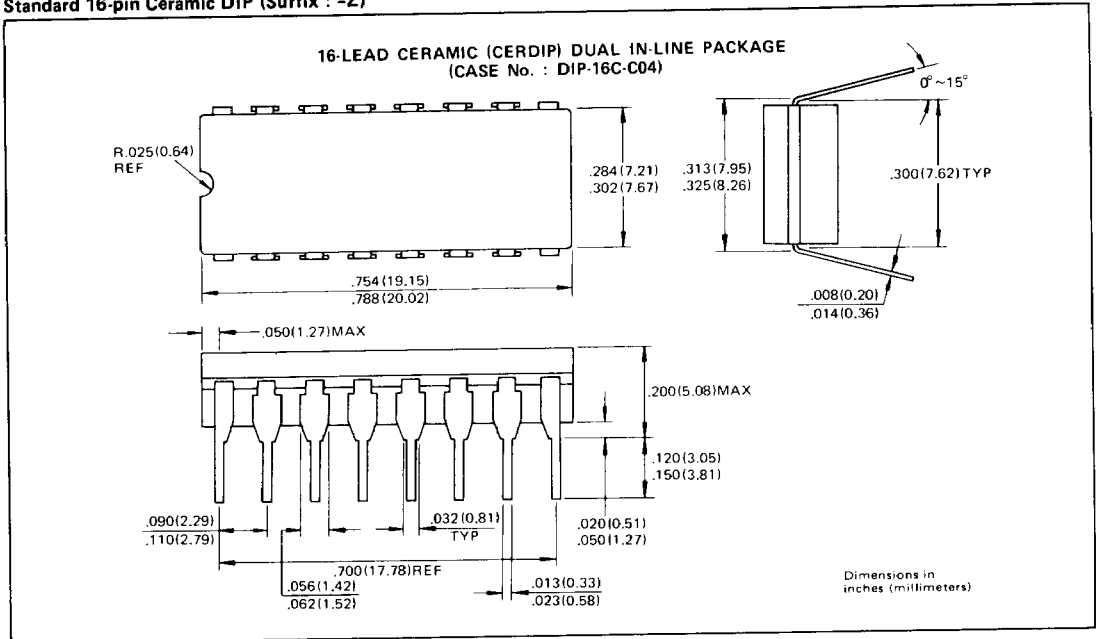

Fig. 22 – SUBSTRATE VOLTAGE vs SUPPLY VOLTAGE (DURING POWER UP)



PACKAGE DIMENSIONS

Standard 16-pin Ceramic DIP (Surfix : -Z)



Standard 16-pin Plastic DIP (Surfix : -P)

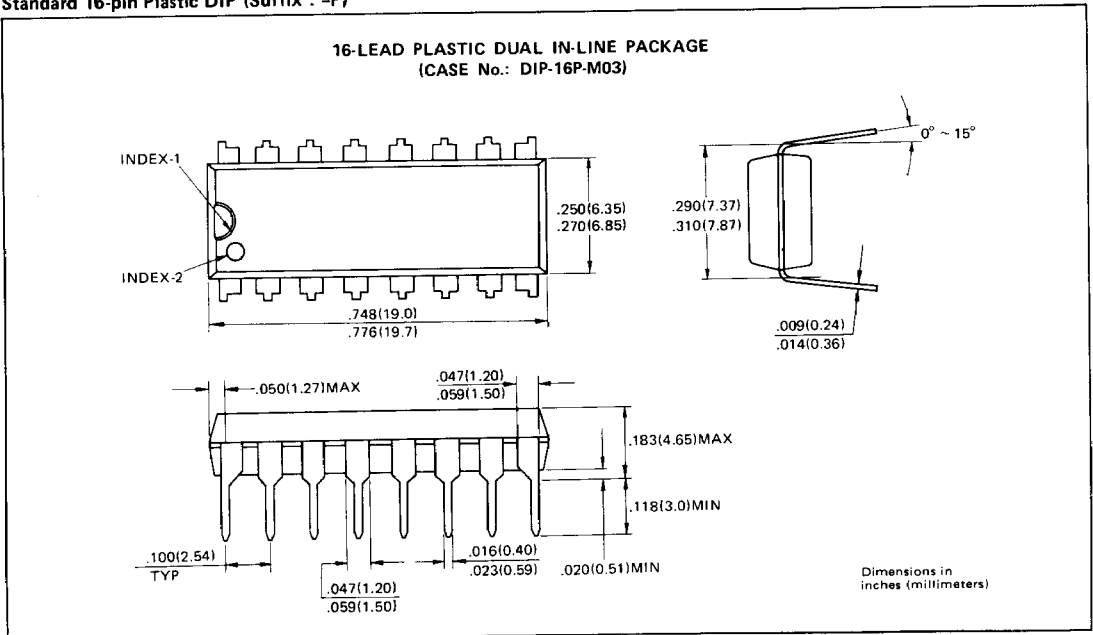



MB 8264A-10
FUJITSU MB 8264A-12
MB 8264A-15

PACKAGE DIMENSIONS

Standard 18-pad Ceramic LCC (Surfix : -TV)

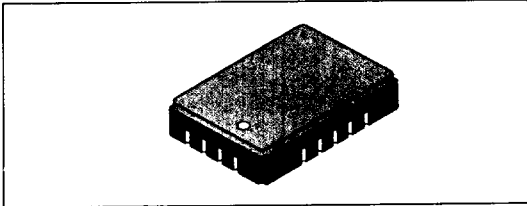

18-PAD CERAMIC (FRIT SEAL) LEADLESS CHIP CARRIER
 (CASE No.: LCC-18C-F02)

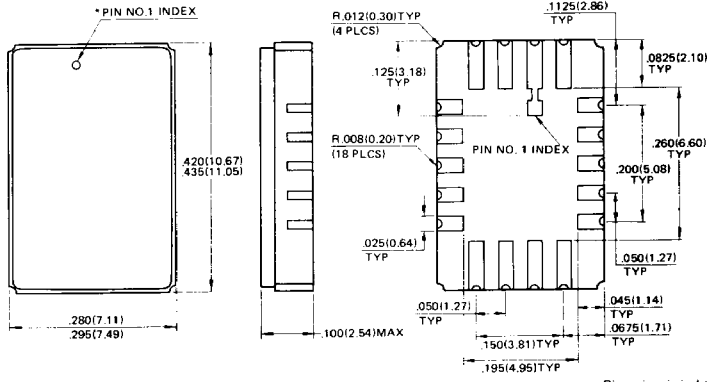

*Shape of Pin 1 index: Subject to change without notice

Dimensions in inches
 (millimeters)