

LM160/LM260/LM360



T-73-53

LM160/LM260/LM360 High Speed Differential Comparator

General Description

The LM160/LM260/LM360 is a very high speed differential input, complementary TTL output voltage comparator with improved characteristics over the μ A760/ μ A760C, for which it is a pin-for-pin replacement. The device has been optimized for greater speed, input impedance and fan-out, and lower input offset voltage. Typically delay varies only 3 ns for overdrive variations of 5 mV to 400 mV.

Complementary outputs having minimum skew are provided. Applications involve high speed analog to digital converters and zero-crossing detectors in disk file systems.

Features

- Guaranteed high speed 20 ns max
- Tight delay matching on both outputs
- Complementary TTL outputs
- High input impedance
- Low speed variation with overdrive variation
- Fan-out of 4
- Low input offset voltage
- Series 74 TTL compatible

Connection Diagrams

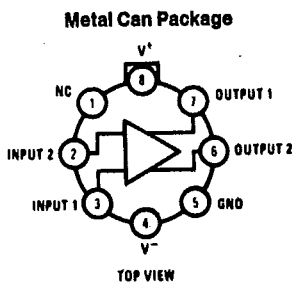

TL/H/5707-4

Order Number LM160H, LM260H or LM360H
See NS Package Number H08C

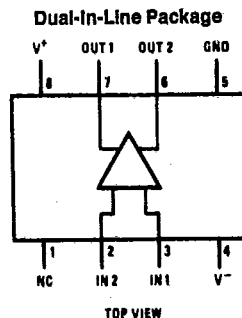

TL/H/5707-5

Order Number LM360M or LM360N
See NS Package Number M08A or N08E

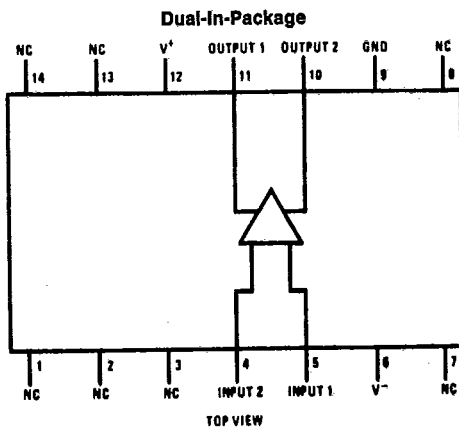

TL/H/5707-6

Order Number LM160J-14, LM360J-14 or LM360N-14
See NS Package Number J14A or N14A

Absolute Maximum Ratings (Note 5)

If Military/Aerospace specified devices are required, please contact the National Semiconductor Sales Office/Distributors for availability and specifications.

(Note 7)

Positive Supply Voltage	+8V
Negative Supply Voltage	-8V
Peak Output Current	20 mA
Differential Input Voltage	±5V
Input Voltage	$V^+ \geq V_{IN} \geq V^-$
ESD rating is to be determined.	

Operating Temperature Range	
LM160	-55°C to +125°C
LM260	-25°C to +85°C
LM360	0°C to +70°C
Storage Temperature Range	
-65°C to +150°C	
Lead Temperature (Soldering, 10 sec.)	
260°C	
Soldering Information	
Dual-In-Line Package	
Soldering (10 seconds)	260°C
Small Outline Package	
Vapor Phase (60 seconds)	215°C
Infrared (15 seconds)	220°C

See AN-450 "Surface Mounting Methods and Their Effect on Product Reliability" for other methods of soldering surface mount devices.

Electrical Characteristics ($T_{MIN} \leq T_A \leq T_{MAX}$)

Parameter	Conditions	Min	Typ	Max	Units
Operating Conditions					
Supply Voltage V_{CC}^+		4.5	5	6.5	V
Supply Voltage V_{CC}^-		-4.5	-5	-6.5	V
Input Offset Voltage	$R_S \leq 200\Omega$		2	5	mV
Input Offset Current			0.5	3	μA
Input Bias Current			5	20	μA
Output Resistance (Either Output)	$V_{OUT} = V_{OH}$		100		Ω
Response Time	$T_A = 25^\circ C, V_S = \pm 5V$ (Notes 1, 6)		13	25	ns
	$T_A = 25^\circ C, V_S = \pm 5V$ (Notes 2, 6)		12	20	ns
	$T_A = 25^\circ C, V_S = \pm 5V$ (Notes 3, 6)		14		ns
Response Time Difference between Outputs					
$(t_{pd} \text{ of } +V_{IN1}) - (t_{pd} \text{ of } -V_{IN2})$	$T_A = 25^\circ C$ (Notes 1, 6)		2		ns
$(t_{pd} \text{ of } +V_{IN2}) - (t_{pd} \text{ of } -V_{IN1})$	$T_A = 25^\circ C$ (Notes 1, 6)		2		ns
$(t_{pd} \text{ of } +V_{IN1}) - (t_{pd} \text{ of } +V_{IN2})$	$T_A = 25^\circ C$ (Notes 1, 6)		2		ns
$(t_{pd} \text{ of } -V_{IN1}) - (t_{pd} \text{ of } -V_{IN2})$	$T_A = 25^\circ C$ (Notes 1, 6)		2		ns
Input Resistance	$f = 1 \text{ MHz}$		17		k Ω
Input Capacitance	$f = 1 \text{ MHz}$		3		pF
Average Temperature Coefficient of Input Offset Voltage	$R_S = 50\Omega$		8		$\mu V/^\circ C$
Average Temperature Coefficient of Input Offset Current			7		nA/°C
Common Mode Input Voltage Range	$V_S = \pm 6.5V$	±4	±4.5		V
Differential Input Voltage Range		±5			V
Output High Voltage (Either Output)	$I_{OUT} = -320 \mu A, V_S = \pm 4.5V$	2.4	3		V
Output Low Voltage (Either Output)	$I_{SINK} = 6.4 \text{ mA}$		0.25	0.4	V
Positive Supply Current	$V_S = \pm 6.5V$		18	32	mA
Negative Supply Current	$V_S = \pm 6.5V$		-9	-16	mA

Note 1: Response time measured from the 50% point of a 30 mVp-p 10 MHz sinusoidal input to the 50% point of the output.
Note 2: Response time measured from the 50% point of a 2 Vp-p 10 MHz sinusoidal input to the 50% point of the output.
Note 3: Response time measured from the start of a 100 mV input step with 5 mV overdrive to the time when the output crosses the logic threshold.

Note 4: Typical thermal impedances are as follows:

Cavity DIP (J):	θ_{JA}	135°C/W	Header (H):	θ_{JA}	165°C/W	(Still Air)
Molded DIP (N):	θ_{JA}	130°C/W		θ_{JC}	67°C/W	(400 LF/min Air Flow)
					25°C/W	

Note 5: The device may be damaged if used beyond the maximum ratings.

Note 6: Measurements are made in AC Test Circuit, Fanout = 1

Note 7: Refer to RETS 160X for LM160H, LM160J-14 and LM160J military specifications.

5

Typical Performance Characteristics

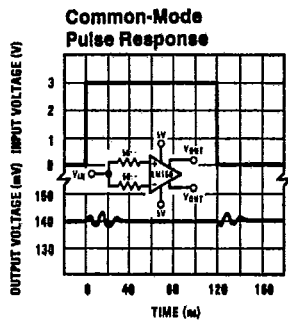
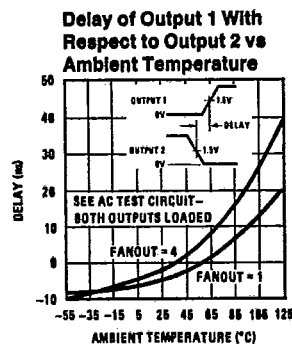
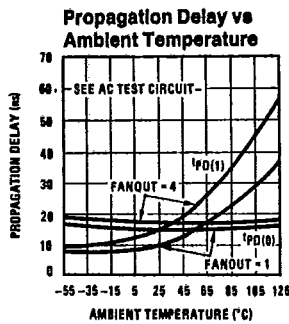
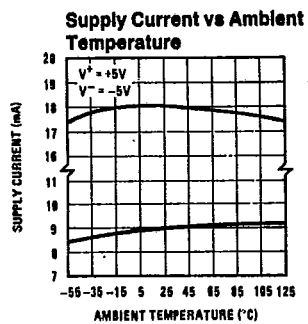
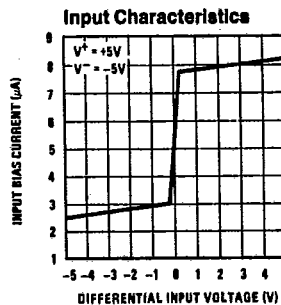
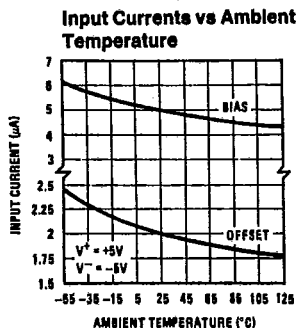
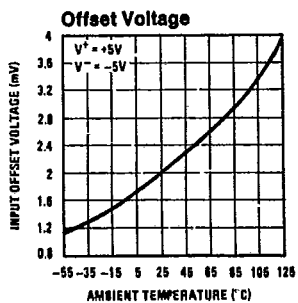

AC Test Circuit

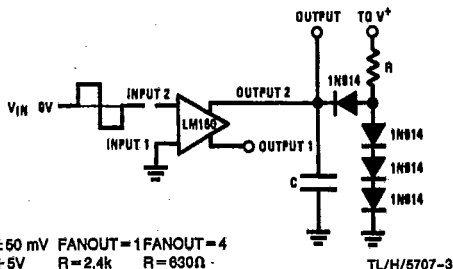

Schematic Diagram

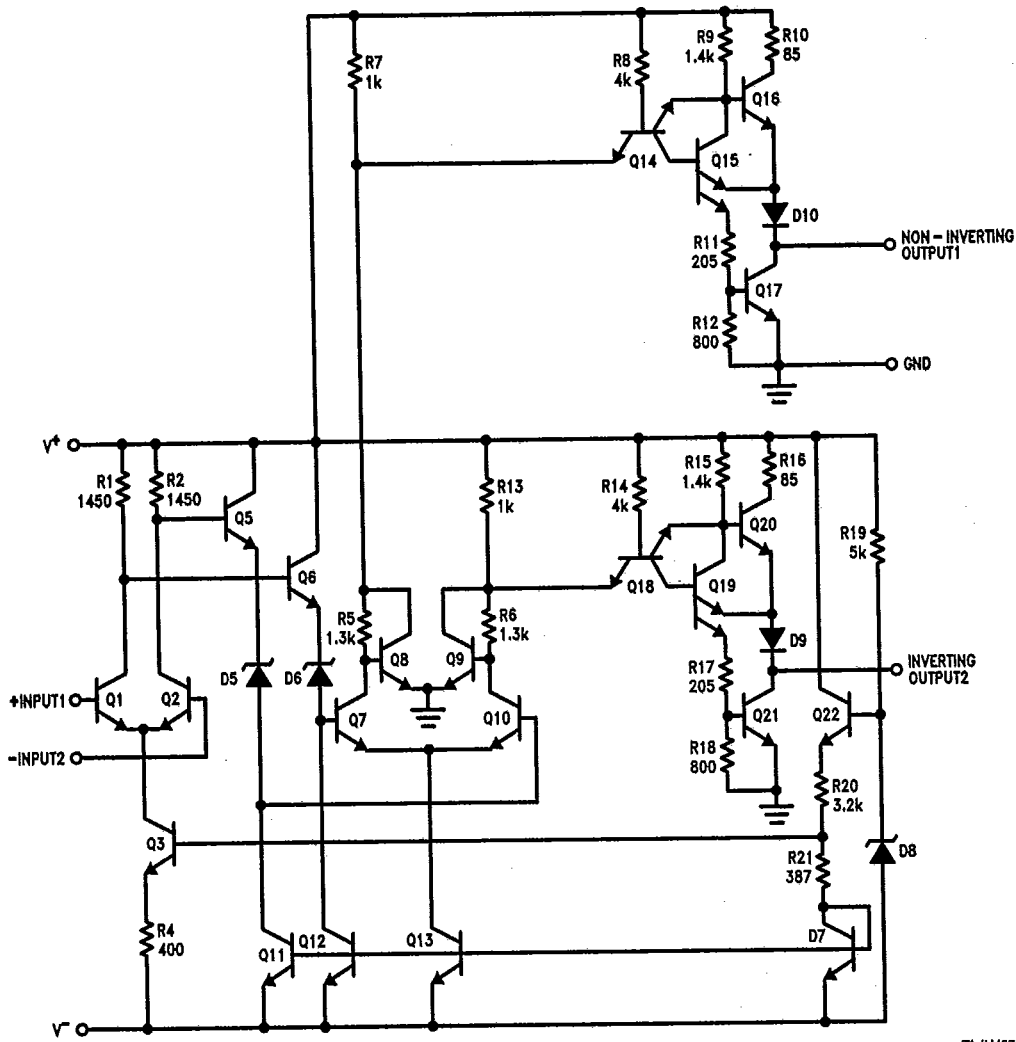

TL/H/6707-1