

## 37.5-150W DC/DC Power Modules 48V Input Series

- *High efficiency 91.5% Typ (5V) at full load*
- *Industry standard footprint*
- *Max case temperature +100°C*
- *Wide input voltage range according to ETSI specifications*
- *High power density, up to 55W/in<sup>3</sup>*
- *1,500 Vdc isolation voltage*
- *MTBF > 3 million hours in accordance with Bellcore TR-332*



The PKJ series represents a “third generation” of High Density DC/DC Power Modules providing 90% efficiency. To achieve this high efficiency, Ericsson uses proprietary drive and control circuits with planar magnetics and low resistivity multilayer PCB technology, and a patent pending topology with active rectification. The PKJ series can be used without bulky and height consuming heatsinks, resulting in a lower total cost. This also provides narrow board spacing for electronic, shelf based applications.

The products are in the industry standard package size and offer a beneficial alternative to competing products on the market. Because for certain applications they may not require heatsinks, they are ideal for cost sensitive or high-density applications.

The PKJ series also offers the flexibility of using a heatsink when needed, enabling reduced airflow, extended reliability or higher ambient temperature operation in a wide range of 48V and 60V DC powered systems. Similar to other Ericsson Power Modules, the PKJ series includes an under-voltage shut down facility, protecting the associated batteries from being too deeply discharged. The PKJ series also offers over-voltage protection, over-temperature protection and is short circuit proof.

These products are manufactured using highly automated manufacturing lines with a world-class quality commitment and a five-year warranty. Ericsson Components AB has been an ISO 9001 certified supplier since 1991. *For product program please see back cover.*

# General

## Absolute Maximum Ratings

Characteristics		min	max	Unit
T <sub>C</sub>	Maximum Operating Case Temperature	-40	+100	°C
T <sub>S</sub>	Storage temperature	-40	+125	°C
V <sub>I</sub>	Continuous input voltage	-0.5	+75	Vdc
V <sub>ISO</sub>	Isolation voltage (input to output test voltage)	1,500		Vdc
V <sub>RC</sub>	Remote control voltage		15	Vdc
I <sup>2</sup> t	Inrush transient		1	A <sup>2</sup> s

Stress in excess of Absolute Maximum Ratings may cause permanent damage. Absolute Maximum Ratings, sometimes referred to as no destruction limits, are normally tested with one parameter at a time exceeding the limits of Output data or Electrical Characteristics.

If exposed to stress above these limits, function and performance may degrade in an unspecified manner. For design margin and to enhance system reliability, it is recommended that the PKJ series DC/DC power modules are operated at case temperatures below 90°C.

## Input T<sub>C</sub> < T<sub>Cmax</sub>

Characteristics		Conditions		min	typ	max	Unit
V <sub>I</sub>	Input voltage range <sup>1)</sup>			36		72	Vdc
V <sub>Ioff</sub>	Turn-off input voltage	Ramping from higher voltage		31	33		Vdc
V <sub>Ion</sub>	Turn-on input voltage	Ramping from lower voltage			34	36	Vdc
C <sub>I</sub>	Input capacitance				2.8		µF
I <sub>lac</sub>	Reflected ripple current	5 Hz to 20 MHz-150W			20		mA p-p
I <sub>I</sub> max	Maximum input current	V <sub>I</sub> = V <sub>I</sub> min	50 W 75 W 100 W 150 W			1.6 2.4 3.2 5.3	A
P <sub>li</sub>	Input idling power	I <sub>O</sub> = 0		2.5	7.5		W
P <sub>RC</sub>	Input stand-by power (turned off with RC)	V <sub>I</sub> = 50V	RC open	.05	2.5		W
TRIM	Maximum input voltage on trim pin					6	Vdc

1) See also Input Voltage in the Operating Information section

## Safety

The PKJ Series DC/DC power modules are designed to comply with EN 60 950 Safety of information technology equipment including electrical business equipment.

The PKJ DC/DC power modules are also recognized by UL and meet the applicable requirements in UL 1950, Safety of information technology equipment and applicable Canadian safety requirements.

The isolation is an operational insulation in accordance with EN 60 950. The DC/DC power module should be installed in end-use equipment, in compliance with the requirements of the ultimate application, and is intended to be supplied by an isolated secondary circuit. Consideration should be given to measuring the case temperature to comply with T<sub>Cmax</sub> when in operation.

When the supply to the DC/DC power module meets all the requirements for SELV (<60Vdc), the output is considered to remain within SELV limits (level 3). If connected to a 60V DC power system, reinforced insulation must be provided in the power supply that isolates the input from the mains. Single fault testing in the power supply must be performed in combination with the DC/DC power module to demonstrate that the output meets the requirement for SELV. One pole of the input and one pole of the output is to be grounded or both are to be kept floating.

## Environmental Characteristics

Characteristics	Test procedure & conditions		
Random Vibration	IEC 68-2-34E <sub>d</sub>	Frequency Spectral density Duration	10...500 Hz 0.025 g <sup>2</sup> /Hz 10 min in each direction
Sinusoidal Vibration	IEC 68-2-6 F <sub>c</sub>	Frequency Amplitude Acceleration # of cycles	10-500 Hz 0.75mm 10g 10 in each axis
Shock (half sinus)	IEC 68-2-27 E <sub>a</sub>	Peak acceleration Duration	50 g 3ms
Temperature change	IEC 68-2-14 N <sub>a</sub>	Temperature Number of cycles	-40°C...+100°C 300
Accelerated damp heat	IEC 68-2-3 C <sub>a</sub> with bias	Temperature Humidity Duration	85°C 85% RH 500 hours
Solder resistibility	IEC 68-2-20 T <sub>b</sub> method IA	Temperature, solder Duration	260° C 10...13 s

## Safety (continued)

The galvanic isolation is verified in an electric strength test. The test voltage ( $V_{ISO}$ ) between input and output is 1,500 Vdc for 60 sec. Leakage current is less than 1 $\mu$ A @ 50Vdc.

Flammability ratings of the terminal support and internal plastic construction details meet UL 94V-0.

A fuse should be used at the input of each PKJ series power module.

If a fault occurs in the power module, that imposes a short on the input source, this fuse will provide the following two functions:

- Isolate the failed module from the input source so that the remainder of the system may continue operation.
- Protect the distribution wiring from overheating.

A fast blow fuse should be used with a rating of 10A or less. It is recommended to use a fuse with the lowest current rating, that is suitable for the application.

## Mechanical Data

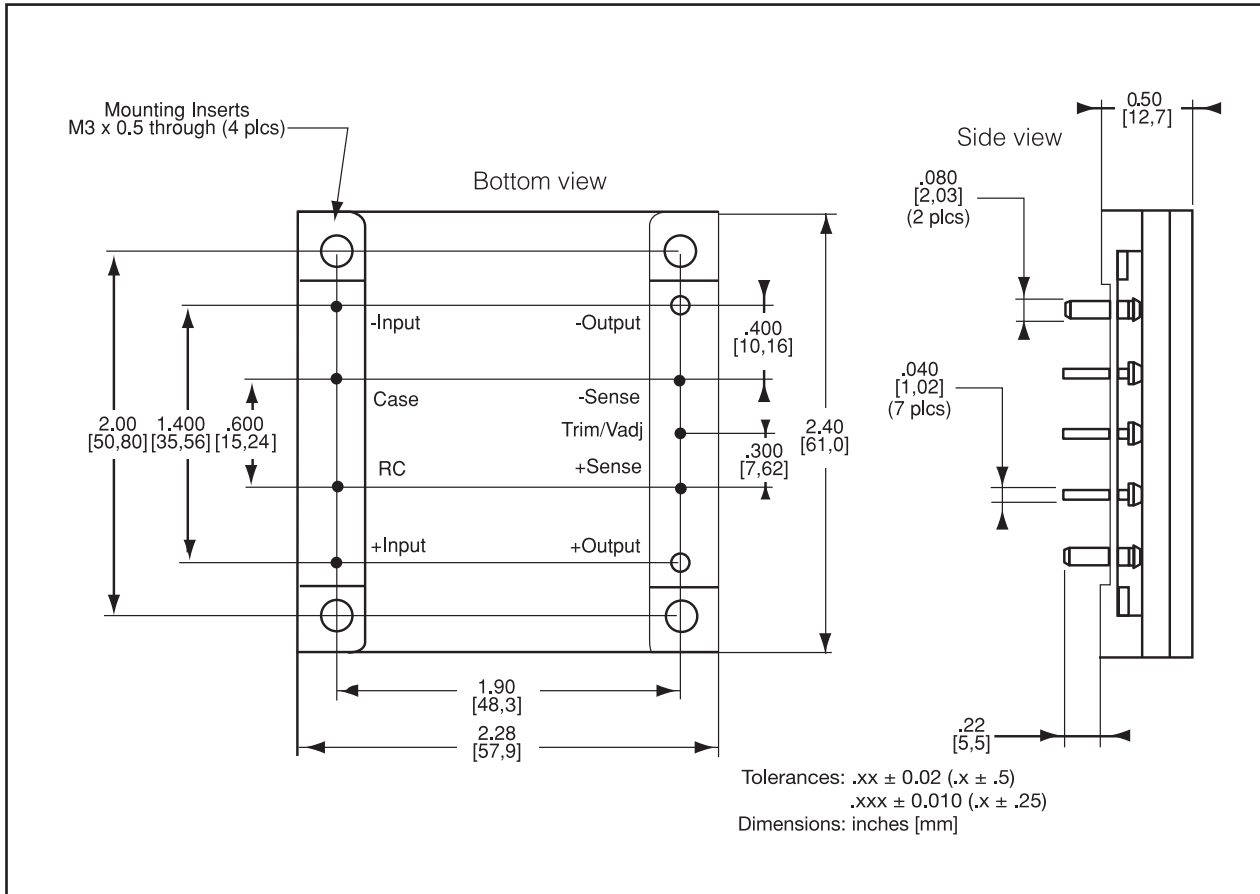

## Connections

Designation	Function
-In	Negative input
Case	Connected to base plate
RC	Remote control (primary). To turn-on and turn-off the output
+In	Positive input
-Out	Negative output
-Sen	Negative remote sense (if sense not needed, connect to -Out)
Trim	Output voltage adjust
+Sen	Positive remote sense (if sense not needed, connect to +Out)
+Out	Positive output

## Weight

85 grams

## Case

Aluminum baseplate with metal standoffs.

## Pins

Pin material: Brass

Pin plating: Tin/Lead over Nickel.

# Thermal Data

The PKJ series DC/DC power modules has a robust thermal design which allows operation at case (baseplate) temperatures ( $T_C$ ) up to  $+100^\circ\text{C}$ . The main cooling mechanism is convection (free or forced) through the case or optional heatsinks.

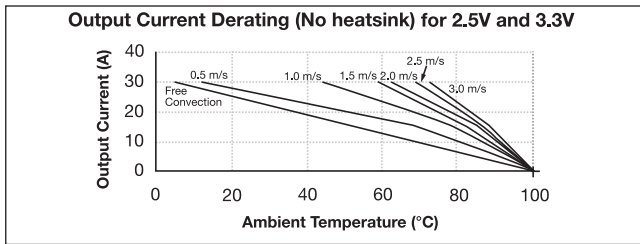

The graph above shows the allowable maximum output current to maintain a maximum  $+100^\circ\text{C}$  case temperature. Note that the ambient temperature is the air temperature adjacent to the power module which is typically elevated above the room environmental temperature.

The graphs below can be used to estimate case temperatures for given system operating conditions (see Thermal design). For further information on optional heatsinks, please contact your local Ericsson sales office.

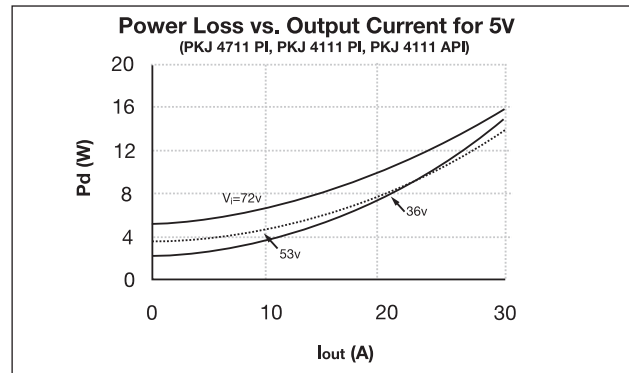
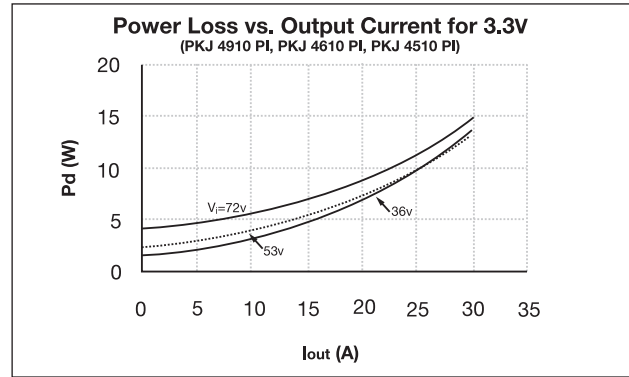
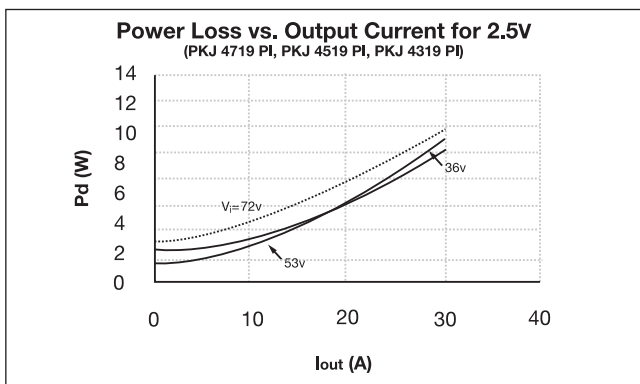
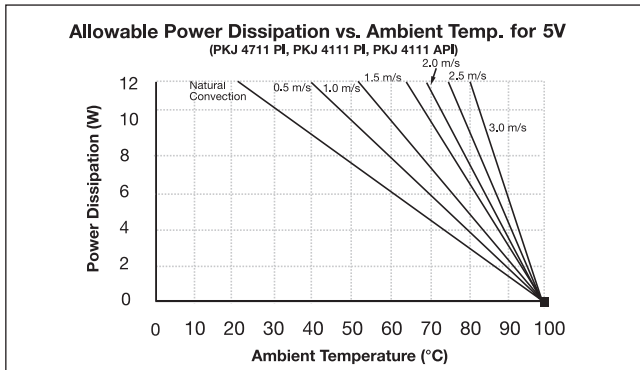
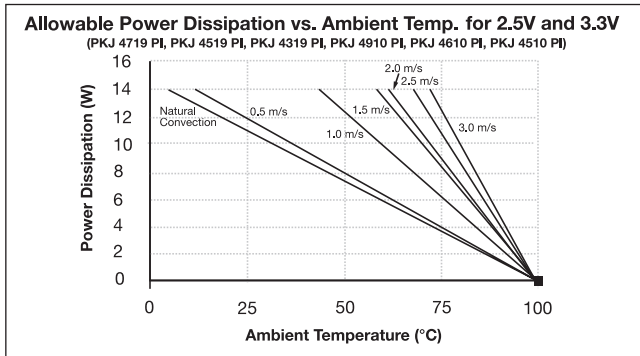

## Thermal Design

The thermal data can be used to determine thermal performance without a heatsink.

Case temperature is calculated by the following formula:

$$T_C = T_A + P_d \times R_{thC-A} \text{ where } P_d = P_O / (\eta - 1)$$

Where:

$T_C$ : Case Temperature

$T_A$ : Local Ambient Temperature

$P_d$ : Dissipated Power

$R_{thC-A}$ : Thermal Resistance from  $T_C$  to  $T_A$

The efficiency  $\eta$  can be found in the tables on the following pages.

For design margin and to enhance system reliability, it is recommended that the PKJ series DC/DC power modules are operated at case temperatures below  $90^\circ\text{C}$ .

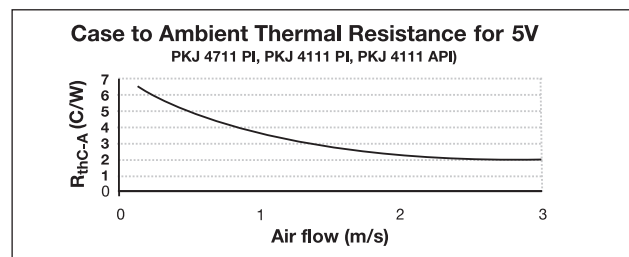
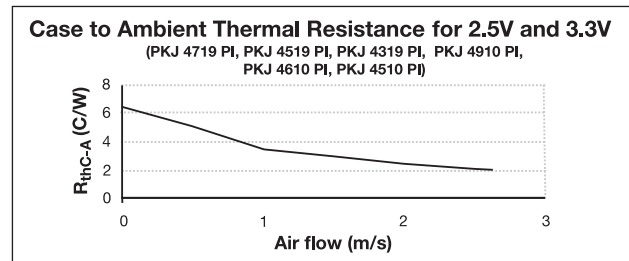

# PKJ 4719 PI (75W)

$T_C = -40...+100^{\circ}\text{C}$ ,  $V_I = 36...72\text{ V}$  dc unless otherwise specified.

## Output

Characteristics		Conditions		Output			Unit
				min	typ	max	
$V_{O_i}$	Output voltage initial setting and accuracy	$T_C = +25^{\circ}\text{C}$ , $V_I = 53\text{V}$ , $I_O = I_{Omax}$		2.45	2.5	2.55	V
	Output adjust range	$I_O = 0$ to $I_{Omax}$		2.0		2.75	V
$V_O$	Output voltage tolerance band	$I_O = 0$ to $I_{Omax}$		2.38		2.63	V
	Line regulation	$V_I = 36...72\text{V}$ , $I_O = I_{Omax}$			2	15	mV
	Load regulation	$V_I = 53\text{V}$ , $I_O = 0$ to $I_{Omax}$			2	15	mV
$V_{tr}$	Load transient voltage deviation	Load step = $0.25 \times I_{Omax}$ $di/dt = 1\text{A}/\mu\text{s}$		$\pm 160$			mVpeak
$t_{tr}$	Load transient recovery time			50			$\mu\text{s}$
$t_s$	Start-up time	From $V_I$ connection to $V_O = 0.9 \times V_{Onom}$		35	55		ms
$I_O$	Output current			0		30	A
$P_{Omax}$	Max output power	At $V_O = V_{Onom}$				75	W
$I_{lim}$	Current limit threshold	$V_O = 0.90 \times V_{Onom}$ @ $T_C < 100^{\circ}\text{C}$		31	35	41	A
$I_{SC}$	Short circuit current				35	41	A
$V_{Oac}$	Output ripple and noise	$I_O = I_{Omax}$	$f < 20\text{ MHz}$		75	150	mVp-p
SVR	Supply voltage rejection	$f < 1\text{ kHz}$		-53			dB
OVP	Overvoltage protection			3.0	3.3	3.9	V

## Miscellaneous

Characteristics		Conditions		min	typ	max	Unit
$\eta$	Efficiency	$T_A = +25^{\circ}\text{C}$ , $V_I = 53\text{V}$ , $I_O = I_{Omax}$		84	87		%
$P_d$	Power dissipation	$I_O = I_{Omax}$ , $V_I = 53\text{V}$			11.2		W
$f_o$	Switching frequency	$I_O = 0.1...1.0 \times I_{Omax}$			150		kHz

# PKJ 4519 PI (50W)

$T_C = -40...+100^{\circ}\text{C}$ ,  $V_I = 36...72\text{ V}$  dc unless otherwise specified.

## Output

Characteristics		Conditions		Output			Unit
				min	typ	max	
$V_{O_i}$	Output voltage initial setting and accuracy	$T_C = +25^{\circ}\text{C}$ , $V_I = 53\text{V}$ , $I_O = I_{Omax}$		2.45	2.50	2.55	V
	Output adjust range	$I_O = 0$ to $I_{Omax}$		2.0		2.75	V
$V_O$	Output voltage tolerance band	$I_O = 0$ to $I_{Omax}$		2.38		2.63	V
	Line regulation	$V_I = 36...72\text{V}$ , $I_O = 0$ to $I_{Omax}$			2	15	mV
	Load regulation	$V_I = 53\text{V}$ , $I_O = 0$ to $I_{Omax}$			2	15	mV
$V_{tr}$	Load transient voltage deviation	Load step = $0.25 \times I_{Omax}$ $dI/dt = 1\text{A}/\mu\text{s}$		$\pm 100$			mVpeak
$t_{tr}$	Load transient recovery time			50			$\mu\text{s}$
$t_s$	Start-up time	From $V_I$ connection to $V_O = 0.9 \times V_{Onom}$		30	55		ms
$I_O$	Output current			0		20	A
$P_{Omax}$	Max output power	At $V_O = V_{Onom}$				50	W
$I_{lim}$	Current limit threshold	$V_O = 0.90 \times V_{Onom}$ @ $T_C < 100^{\circ}\text{C}$		21	25	31	A
$I_{SC}$	Short circuit current				25	31	A
$V_{Oac}$	Output ripple and noise	$I_O = I_{Omax}$	$f < 20\text{ MHz}$		75	150	mVp-p
SVR	Supply voltage rejection	$f < 1\text{ kHz}$		-53			dB
OVP	Overvoltage protection			3.0	3.3	3.9	V

## Miscellaneous

Characteristics		Conditions		min	typ	max	Unit
$\eta$	Efficiency	$T_A = +25^{\circ}\text{C}$ , $V_I = 53\text{V}$ , $I_O = I_{Omax}$		86	89		%
$P_d$	Power dissipation	$I_O = I_{Omax}$ , $V_I = 53\text{V}$			6.2		W
$f_o$	Switching frequency	$I_O = 0.1...1.0 \times I_{Omax}$			150		kHz

# PKJ 4319 PI (37.5W)

$T_C = -40...+100^{\circ}\text{C}$ ,  $V_I = 36...72\text{ V}$  dc unless otherwise specified.

## Output

Characteristics		Conditions		Output			Unit
				min	typ	max	
$V_{O_i}$	Output voltage initial setting and accuracy	$T_C = +25^{\circ}\text{C}$ , $V_I = 53\text{V}$ , $I_O = I_{O_{\text{max}}}$		2.45	2.50	2.55	V
	Output adjust range	$I_O = 0$ to $I_{O_{\text{max}}}$		2.0		2.75	V
$V_O$	Output voltage tolerance band	$I_O = 0$ to $I_{O_{\text{max}}}$		2.38		2.63	V
	Line regulation	$V_I = 36...72\text{V}$ , $I_O = I_{O_{\text{max}}}$			2	15	mV
	Load regulation	$V_I = 53\text{V}$ , $I_O = 0$ to $I_{O_{\text{max}}}$			2	15	mV
$V_{tr}$	Load transient voltage deviation	Load step = $0.25 \times I_{O_{\text{max}}}$ $di/dt = 1\text{A}/\mu\text{s}$			$\pm 90$		mVpeak
$t_{tr}$	Load transient recovery time				50		$\mu\text{s}$
$t_s$	Start-up time	From $V_I$ connection to $V_O = 0.9 \times V_{O_{\text{nom}}}$			30	55	ms
$I_O$	Output current			0		15	A
$P_{O_{\text{max}}}$	Max output power	At $V_O = V_{O_{\text{nom}}}$				37.5	W
$I_{lim}$	Current limit threshold	$V_O = 0.90 \times V_{O_{\text{nom}}}$ @ $T_C < 100^{\circ}\text{C}$		16	17	24	A
$I_{SC}$	Short circuit current				17	25	A
$V_{Oac}$	Output ripple and noise	$I_O = I_{O_{\text{max}}}$	$f < 20\text{ MHz}$		75	150	mVp-p
SVR	Supply voltage rejection	$f < 1\text{ kHz}$		53			dB
OVP	Overvoltage protection			3.0	3.3	3.9	V

## Miscellaneous

Characteristics		Conditions	min	typ	max	Unit
$\eta$	Efficiency	$T_A = +25^{\circ}\text{C}$ , $V_I = 53\text{V}$ , $I_O = I_{O_{\text{max}}}$	86	89		%
$P_d$	Power dissipation	$I_O = I_{O_{\text{max}}}$ , $V_I = 53\text{V}$		4.6		W
$f_o$	Switching frequency	$I_O = 0.1...1.0 \times I_{O_{\text{max}}}$		150		kHz

# PKJ 4910 PI (99W)

$T_C = -40...+100^{\circ}\text{C}$ ,  $V_I = 36...72\text{ V}$  dc unless otherwise specified.

## Output

Characteristics		Conditions		Output			Unit
				min	typ	max	
$V_{O_i}$	Output voltage initial setting and accuracy	$T_C = +25^{\circ}\text{C}$ , $V_I = 53\text{V}$ , $I_O = I_{Omax}$		3.25	3.30	3.35	V
	Output adjust range	$I_O = 0$ to $I_{Omax}$		2.64		3.63	V
$V_O$	Output voltage tolerance band	$I_O = 0$ to $I_{Omax}$		3.2		3.4	V
	Line regulation	$V_I = 36...72\text{V}$ , $I_O = I_{Omax}$			1	10	mV
	Load regulation	$V_I = 53\text{V}$ , $I_O = 0$ to $I_{Omax}$			1	10	mV
$V_{tr}$	Load transient voltage deviation	Load step = $0.25 \times I_{Omax}$ $di/dt = 1\text{A}/\mu\text{s}$		$\pm 180$			$\text{mV}_{peak}$
$t_{tr}$	Load transient recovery time			50			$\mu\text{s}$
$t_S$	Start-up time	From $V_I$ connection to $V_O = 0.9 \times V_{Onom}$		35	60		ms
$I_O$	Output current			0		30	A
$P_{Omax}$	Max output power	At $V_O = V_{Onom}$				100	W
$I_{lim}$	Current limit threshold	$V_O = 0.90 \times V_{Onom}$ @ $T_C < 100^{\circ}\text{C}$		31	35	39	A
$I_{SC}$	Short circuit current				35	41	A
$V_{Oac}$	Output ripple and noise	$I_O = I_{Omax}$	$f < 20\text{ MHz}$		75	150	$\text{mVp-p}$
SVR	Supply voltage rejection (ac)	$f < 1\text{ kHz}$		-53			dB
OVP	Over voltage protection	$V_I = 53\text{V}$		3.9	4.4	5.0	V

## Miscellaneous

Characteristics		Conditions		min	typ	max	Unit
$\eta$	Efficiency	$T_A = +25^{\circ}\text{C}$ , $V_I = 53\text{V}$ , $I_O = I_{Omax}$		86	89		%
$P_d$	Power dissipation	$I_O = I_{Omax}$ , $V_I = 50\text{V}$			12.2		W
$f_O$	Switching frequency	$I_O = 0.1...1.0 \times I_{Omax}$			150		kHz



# PKJ 4610 PI (66W)

$T_C = -40...+100^{\circ}\text{C}$ ,  $V_I = 36...72\text{ V}$  dc unless otherwise specified.

## Output

Characteristics		Conditions		Output			Unit
				min	typ	max	
$V_{O_i}$	Output voltage initial setting and accuracy	$T_C = +25^{\circ}\text{C}$ , $V_I = 53\text{V}$ , $I_O = I_{Omax}$		3.25	3.30	3.35	V
	Output adjust range	$I_O = 0$ to $I_{Omax}$		2.64		3.63	V
$V_O$	Output voltage tolerance band	$I_O = 0$ to $I_{Omax}$		3.2		3.4	V
	Line regulation	$V_I = 36...72\text{V}$ , $I_O = I_{Omax}$			1	10	mV
	Load regulation	$V_I = 53\text{V}$ , $I_O = 0$ to $I_{Omax}$			1	10	mV
$V_{tr}$	Load transient Voltage deviation	Load step = $0.25 \times I_{Omax}$ $di/dt = 1\text{A}/\mu\text{s}$		$\pm 140$			$\text{mV}_{peak}$
$t_{tr}$	Load transient recovery time			50			$\mu\text{s}$
$t_s$	Start-up time	From $V_I$ connection to $V_O = 0.9 \times V_{Onom}$			35	60	ms
$I_O$	Output current			0		20	A
$P_{Omax}$	Max output power	At $V_O = V_{Onom}$				66.6	W
$I_{lim}$	Current limit threshold	$V_O = 0.90 \times V_{Onom}$ @ $T_C < 100^{\circ}\text{C}$		21	24	30	A
$I_{SC}$	Short circuit current				28	32	A
$V_{Oac}$	Output ripple and noise	$I_O = I_{Omax}$	$f < 20\text{ MHz}$		75	150	$\text{mV}_{p-p}$
SVR	Supply voltage rejection (ac)	$f < 1\text{kHz}$		-53			dB
OVP	Over voltage protection			3.9	4.4	5.0	V

## Miscellaneous

Characteristics		Conditions		min	typ	max	Unit
$\eta$	Efficiency	$T_A = +25^{\circ}\text{C}$ , $V_I = 53\text{V}$ , $I_O = I_{Omax}$		88	90.5		%
$P_d$	Power dissipation	$I_O = I_{Omax}$ , $V_I = 53\text{V}$			6.93		W
$f_O$	Switching frequency	$I_O = 0.1...1.0 \times I_{Omax}$			150		kHz

# PKJ 4510 PI (50W)

$T_C = -40...+100^{\circ}\text{C}$ ,  $V_I = 36...72\text{ V}$  dc unless otherwise specified.

## Output

Characteristics		Conditions		Output			Unit
				min	typ	max	
$V_{O1}$	Output voltage initial setting and accuracy	$T_C = +25^{\circ}\text{C}$ , $V_I = 53\text{V}$ , $I_O = I_{Omax}$		3.25	3.30	3.35	V
	Output adjust range	$I_O = 0$ to $I_{Omax}$		2.64		3.63	V
$V_O$	Output voltage tolerance band	$I_O = 0$ to $I_{Omax}$		3.2		3.4	V
	Line regulation	$V_I = 36...72\text{V}$ , $I_O = I_{Omax}$			1	10	mV
	Load regulation	$V_I = 53\text{V}$ , $I_O = 0$ to $I_{Omax}$			1	10	mV
$V_{tr}$	Load transient Voltage deviation	Load step = $0.25 \times I_{Omax}$ $di/dt = 1\text{A}/\mu\text{s}$			$\pm 100$		$\text{mV}_{peak}$
$t_{tr}$	Load transient recovery time				50		$\mu\text{s}$
$t_s$	Start-up time	From $V_I$ connection to $V_O = 0.9 \times V_{Onom}$			35	60	ms
$I_O$	Output current			0		15	A
$P_{Omax}$	Max output power	At $V_O = V_{Onom}$				50	W
$I_{lim}$	Current limit threshold	$V_O = 0.90 \times V_{Onom} @ T_C < 100^{\circ}\text{C}$		16	19	22	A
$I_{SC}$	Short circuit current				21	23	A
$V_{Oac}$	Output ripple and noise	$I_O = I_{Omax}$	$f < 20\text{ MHz}$		75	150	$\text{mVp-p}$
SVR	Supply voltage rejection (ac)	$f < 1\text{ kHz}$		-53			dB
OVP	Over voltage protection			3.9	4.4	5.0	V

## Miscellaneous

Characteristics		Conditions		min	typ	max	Unit
$\eta$	Efficiency	$T_A = +25^{\circ}\text{C}$ , $V_I = 53\text{V}$ , $I_O = I_{Omax}$		88	90.5		%
$P_d$	Power dissipation	$I_O = I_{Omax}$ , $V_I = 53\text{V}$			5.2		W
$f_O$	Switching frequency	$I_O = 0.1...1.0 \times I_{Omax}$			150		kHz

# PKJ 4111 API (150W)

$T_C = -40...+100^{\circ}\text{C}$ ,  $V_I = 36...72\text{ V}$  dc unless otherwise specified.

## Output

Characteristics		Conditions		Output			Unit
				min	typ	max	
$V_{O_i}$	Output voltage initial setting and accuracy	$T_C = +25^{\circ}\text{C}$ , $V_I = 53\text{V}$ , $I_O = I_{Omax}$		4.9	5.0	5.1	V
	Output adjust range	$I_O = 0.1$ to $I_{Omax}$		4.0		5.5	V
$V_O$	Output voltage tolerance band	$I_O = 0.1$ to $I_{Omax}$		4.85		5.15	V
	Line regulation	$V_I = 36...72\text{V}$ , $I_O = I_{Omax}$			5	20	mV
	Load regulation	$V_I = 53\text{V}$ , $I_O = 0.1$ to $I_{Omax}$			5	20	mV
$V_{tr}$	Load transient voltage deviation	Load step = $0.25 \times I_{Omax}$ $di/dt = 1\text{A}/\mu\text{s}$		$\pm 200$			$\text{mV}_{peak}$
$t_{tr}$				Load transient recovery time	50		
$t_s$	Start-up time	From $V_I$ connection to $V_O = 0.9 \times V_{Onom}$		55	90		ms
$I_O$	Output current			0		30	A
$P_{Omax}$	Max output power	At $V_O = V_{Onom}$				150	W
$I_{lim}$	Current limit threshold	$V_O = .90 \times V_{Onom}$ @ $T_C < 100^{\circ}\text{C}$		31	35	42	A
$I_{SC}$	Short circuit current				35	41	A
$V_{Oac}$	Output ripple and noise	$I_O = I_{Omax}$	$f < 20\text{ MHz}$		75	150	$\text{mV}_{p-p}$
SVR	Supply voltage rejection (ac)	$f < 1\text{ kHz}$		-53			dB
OVP	Over voltage protection			5.8	6.1	7	V

## Miscellaneous

Characteristics		Conditions		min	typ	max	Unit
$\eta$	Efficiency	$T_A = +25^{\circ}\text{C}$ , $V_I = 53\text{V}$ , $I_O = I_{Omax}$		88	90.5		%
$P_d$	Power dissipation	$I_O = I_{Omax}$ , $V_I = 53\text{V}$			15.7		W
$f_o$	Switching frequency	$I_O = 0.1...1.0 \times I_{Omax}$			200		kHz

# PKJ 4111 PI (100W)

$T_C = -40...+100^{\circ}\text{C}$ ,  $V_I = 36...72\text{ V}$  dc unless otherwise specified.

## Output

Characteristics		Conditions		Output			Unit
				min	typ	max	
$V_{O_i}$	Output voltage initial setting and accuracy	$T_C = +25^{\circ}\text{C}$ , $V_I = 53\text{V}$ , $I_O = I_{Omax}$		4.9	5.0	5.1	V
	Output adjust range	$I_O = 0$ to $I_{Omax}$		4.0		5.5	V
$V_O$	Output voltage tolerance band	$I_O = 0$ to $I_{Omax}$		4.85		5.15	V
	Line regulation	$V_I = 36...72\text{V}$ , $I_O = I_{Omax}$			5	20	mV
	Load regulation	$V_I = 53\text{V}$ , $I_O = 0.1$ to $I_{Omax}$			5	20	mV
$V_{tr}$	Load transient voltage deviation	Load step = $0.25 \times I_{Omax}$ $di/dt = 1\text{A}/\mu\text{s}$		$\pm 120$			$\text{mV}_{peak}$
$t_{tr}$	Load transient recovery time			20			$\mu\text{s}$
$t_s$	Start-up time	From $V_I$ connection to $V_O = 0.9 \times V_{Onom}$			55	90	ms
$I_O$	Output current			0		20	A
$P_{Omax}$	Max output power	At $V_O = V_{Onom}$				100	W
$I_{lim}$	Current limiting threshold	$V_O = 0.90 \times V_{Onom}$ @ $T_C < 100^{\circ}\text{C}$		21	25	32	A
$I_{SC}$	Short circuit current				25	31	A
$V_{Oac}$	Output ripple and noise	$I_O = I_{Omax}$	$f < 20\text{ MHz}$		75	150	$\text{mV}_{p-p}$
SVR	Supply voltage rejection (ac)	$f < 1\text{ kHz}$		-53			dB
OVR	Over voltage protection			5.8	6.1	7	V

## Miscellaneous

Characteristics		Conditions	min	typ	max	Unit
$\eta$	Efficiency	$T_A = +25^{\circ}\text{C}$ , $V_I = 53\text{V}$ , $I_O = I_{Omax}$	89	91.5		%
$P_d$	Power dissipation	$I_O = I_{Omax}$ , $V_I = 53\text{V}$		9.3		W
$f_O$	Switching frequency	$I_O = 0.1...1.0 \times I_{Omax}$		200		kHz

# PKJ 4711 PI (75W)

$T_C = -40...+100^{\circ}\text{C}$ ,  $V_I = 36...72\text{ V}$  dc unless otherwise specified.

## Output

Characteristics		Conditions	Output			Unit	
			min	typ	max		
$V_{O_i}$	Output voltage initial setting and accuracy	$T_C = +25^{\circ}\text{C}$ , $V_I = 53\text{V}$ , $I_O = I_{Omax}$	4.9	5.0	5.1	V	
	Output adjust range	$I_O = 0$ to $I_{Omax}$	4.0		5.5	V	
$V_O$	Output voltage tolerance band	$I_O = 0$ to $I_{Omax}$	4.85		5.15	V	
	Line regulation	$V_I = 36...72\text{V}$ , $I_O = I_{Omax}$		5	20	mV	
	Load regulation	$V_I = 53\text{V}$ , $I_O = 0.1$ to $I_{Omax}$		5	20	mV	
$V_{tr}$	Load transient voltage deviation	Load step = $0.25 \times I_{Omax}$ $di/dt = 1\text{A}/\mu\text{s}$		$\pm 100$		$\text{mV}_{peak}$	
$t_{tr}$	Load transient recovery time			15		$\mu\text{s}$	
$t_s$	Start-up time	From $V_I$ connection to $V_O = 0.9 \times V_{Onom}$		55	90	ms	
$I_O$	Output current		0		15	A	
$P_{Omax}$	Max output power	At $V_O = V_{Onom}$			75	W	
$I_{lim}$	Current limiting threshold	$V_O = 0.90 \times V_{Onom}$ @ $T_C < 100^{\circ}\text{C}$	16	20	26	A	
$I_{SC}$	Short circuit current			22	25	A	
$V_{Oac}$	Output ripple and noise	$I_O = I_{Omax}$	f < 20 MHz		75	150	$\text{mV}_{p-p}$
SVR	Supply voltage rejection (ac)	f 1 kHz	-53			dB	
OVP	Over voltage protection		5.8	6.1	7	V	

## Miscellaneous

Characteristics		Conditions	min	typ	max	Unit
$\eta$	Efficiency	$T_A = +25^{\circ}\text{C}$ , $V_I = 53\text{V}$ , $I_O = I_{Omax}$	89	91.5		%
$P_d$	Power dissipation	$I_O = I_{Omax}$ , $V_I = 53\text{V}$		7.0		W
$f_O$	Switching frequency	$I_O = 0.1...1.0 \times I_{Omax}$		200		kHz

# Typical Characteristics

## PKJ 4719 PI (75W)

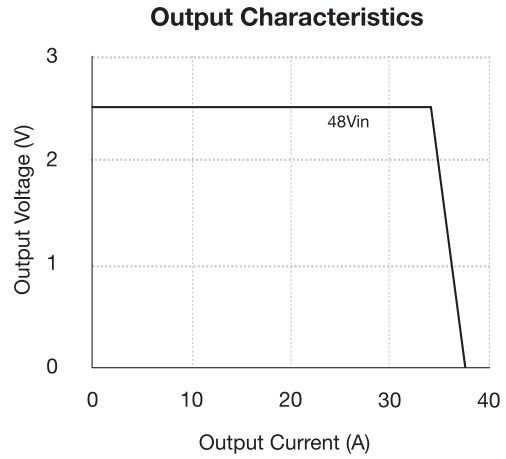
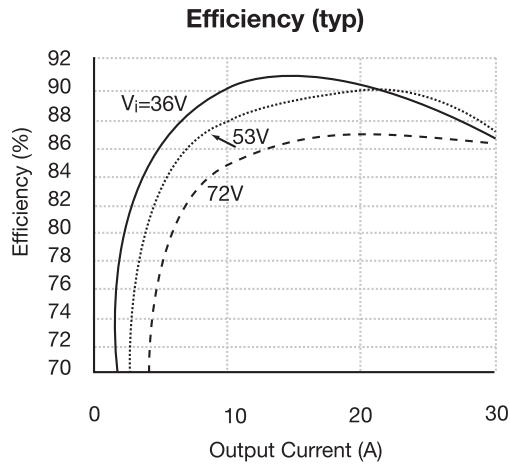

## PKJ 4519 PI (50W)

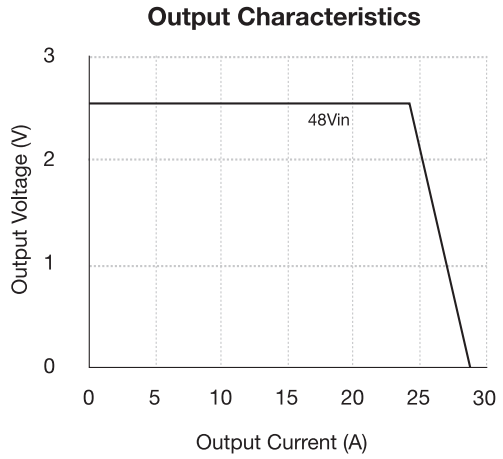
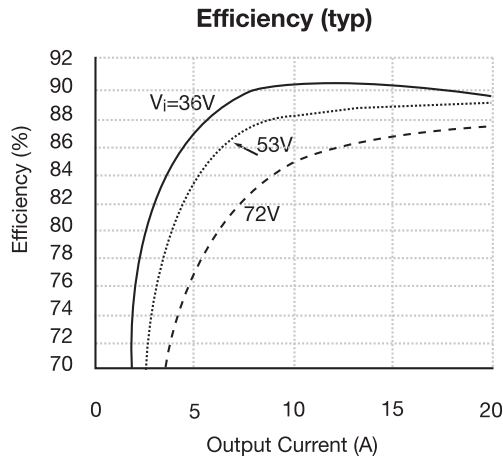

## PKJ 4319 PI (37.5W)

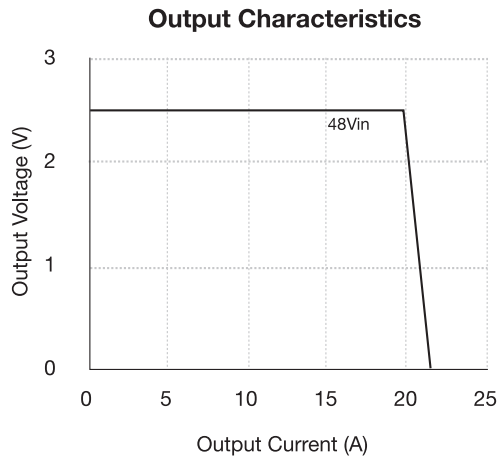
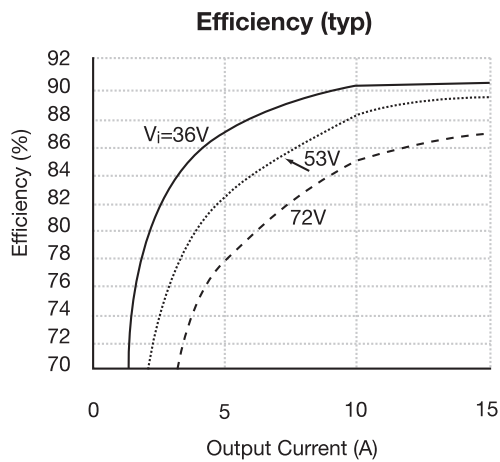

### PKJ 4910 PI (99W)

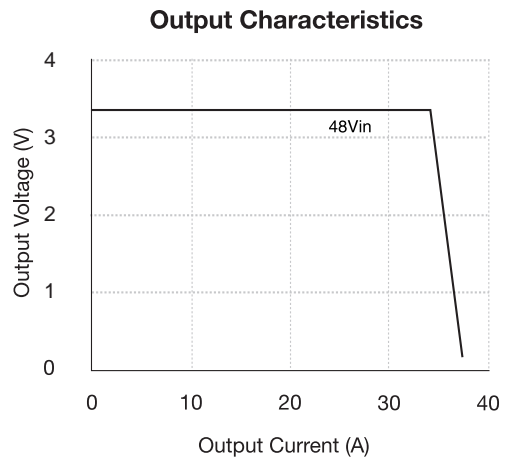
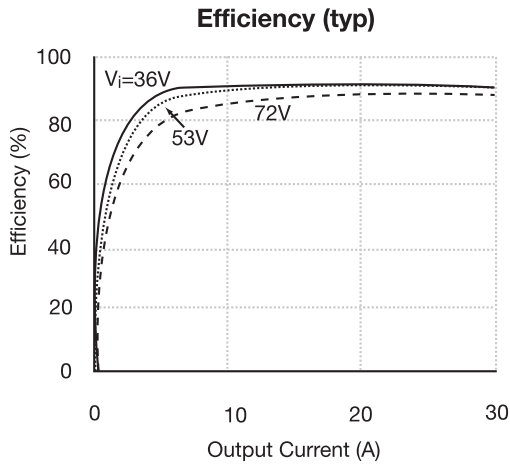

### PKJ 4610 PI (66W)

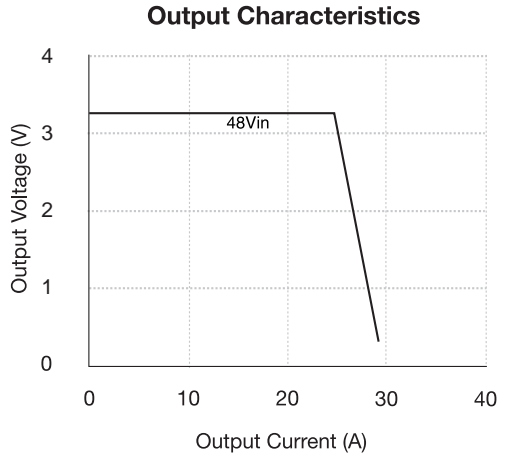
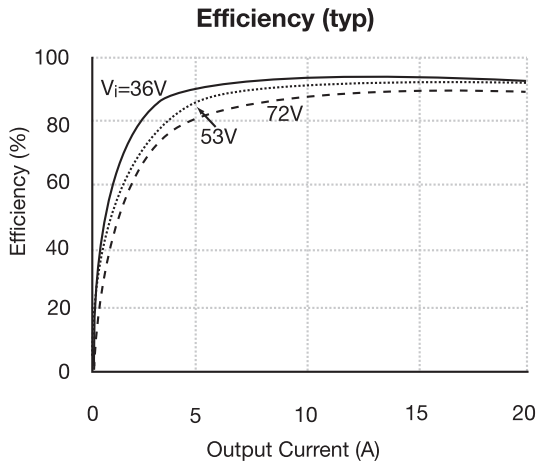

### PKJ 4510 PI (50W)

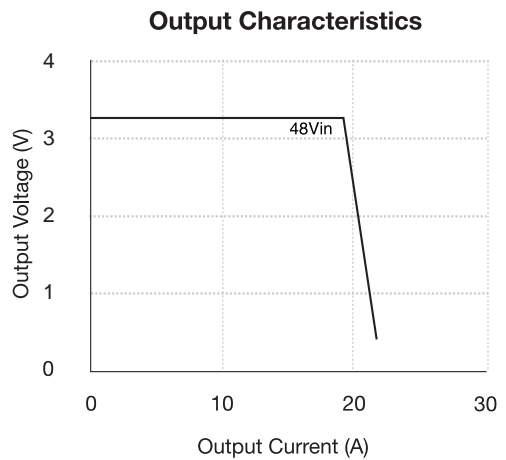
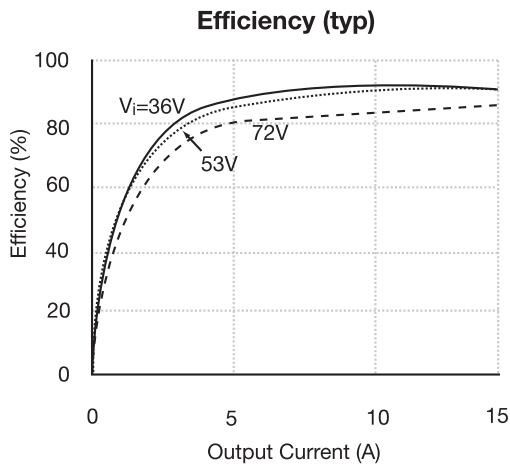

## PKJ 4111 API (150W)

**Efficiency (typ)**

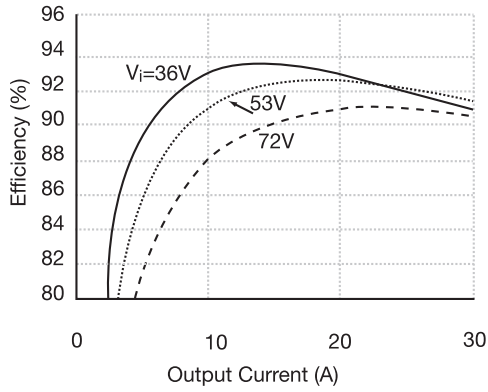

**Output Characteristics**

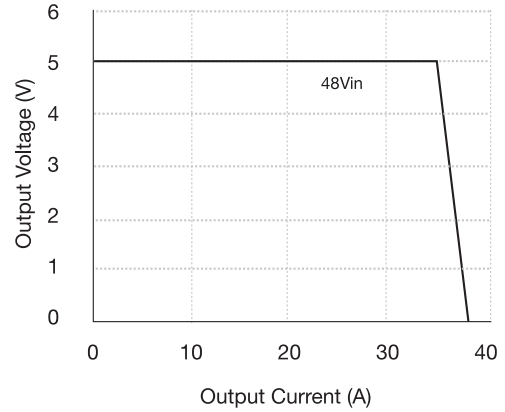

## PKJ 4111 PI (100W)

**Efficiency (typ)**

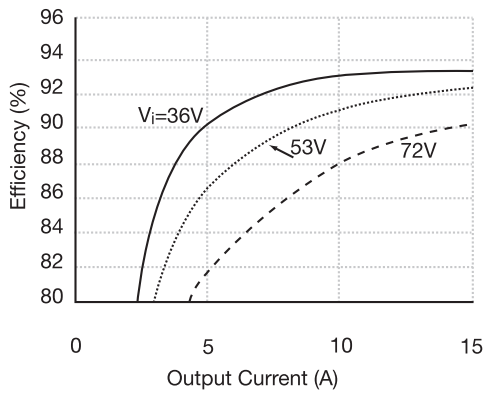

**Output Characteristics**

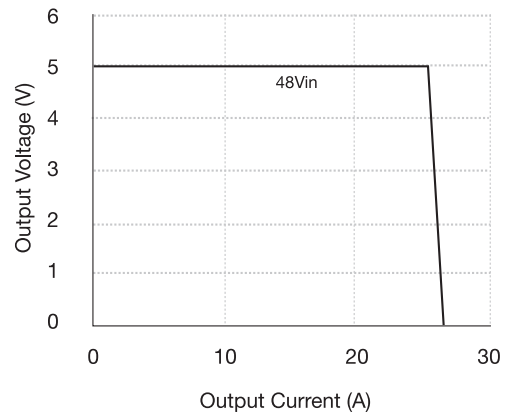

## PKJ 4711 PI (75W)

**Efficiency (typ)**

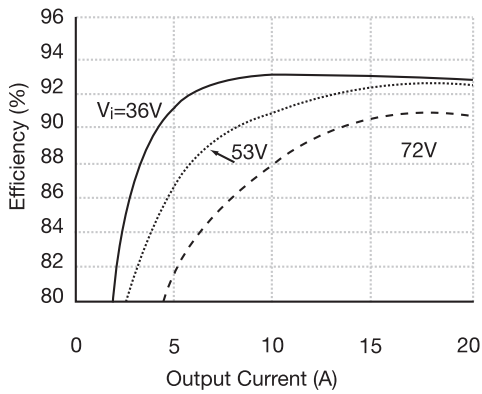

**Output Characteristics**

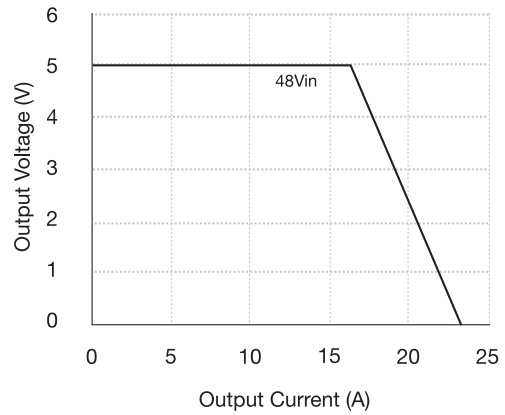



# EMC Specifications

The PKJ power module is mounted on a double sided printed circuit board PCB with groundplane during EMC measurements.

The fundamental switching frequency is 200 kHz @  $I_O = I_{Omax}$ .

## Conducted EMI

Input terminal value with 100µF capacitor (typ) and additional PI filter.

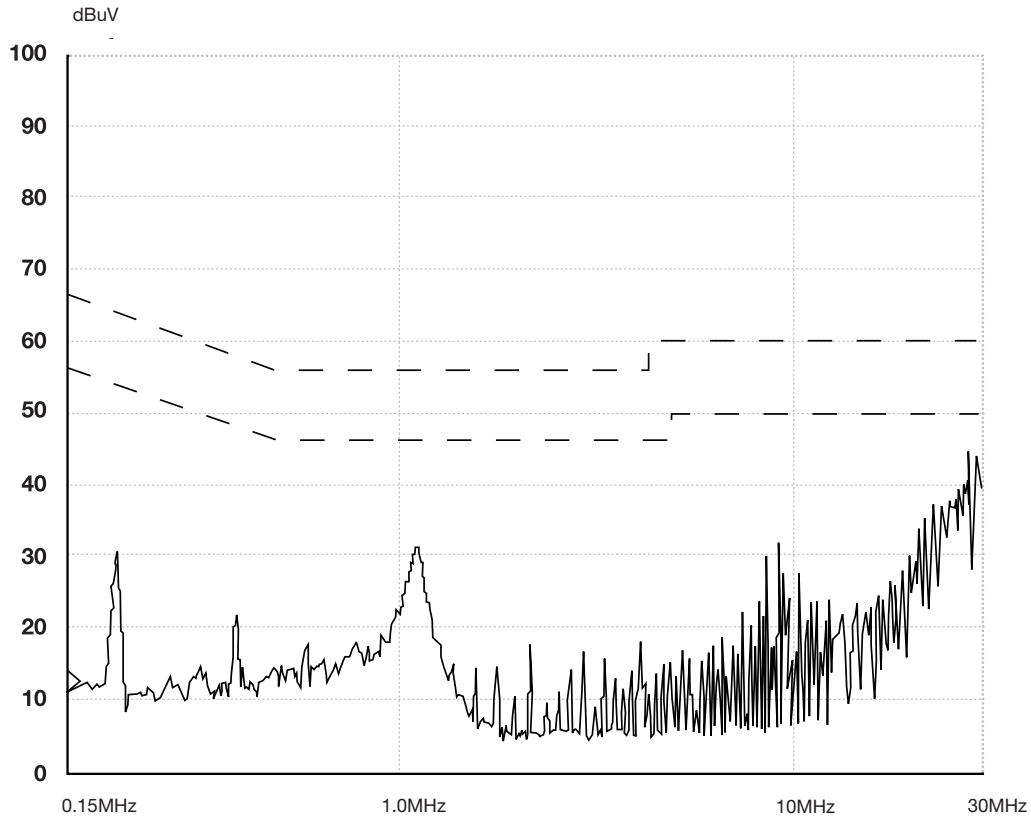

## EMI Filter for PKJ Module

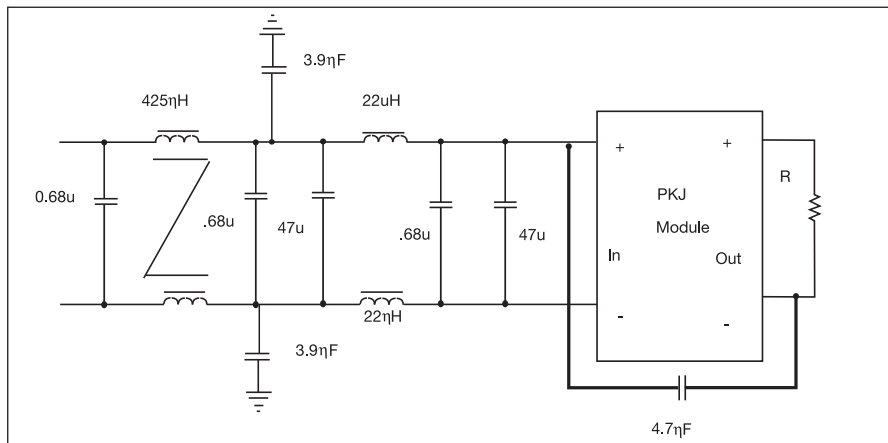

L1: 425µH, 8.1A (Coilcraft P3217A)  
 L2: 22µH, 7A (Coilcraft D055022-223)

# Operating Information

## Input Voltage

The input voltage range 36...72V meets the requirements in the European Telecom Standard ETS 300 132-2 for normal input voltage range in -48 V and -60 V DC power systems, -40.5...-57.0 V and -50.0...-72.0 V respectively. At input voltages exceeding 72 V, (abnormal voltage), the power loss will be higher than at normal input voltage and  $T_C$  must be limited to absolute max +90° C. The absolute max continuous input voltage is 75 V DC. Output characteristics will be marginally affected at input voltages exceeding 72 V.

## Remote Control (RC)

The RC pin can be wired directly to -In, to allow the module to power up automatically without the need for control signals.

A mechanical switch or an open collector transistor or FET can be used to drive the RC inputs. The device must be capable of sinking up to 1mA at a low level voltage of 1.0V, maximum of 15 V dc, for the primary RC.

Standard Remote Control		Optional Remote Control	
RC (primary)	Power module	RC (primary)	Power module
Low	ON	Low	OFF
Open/High	OFF	Open/High	ON

## Remote Sense

All PKJ series DC/DC power modules have remote sense that can be used to compensate for moderate amounts of resistance in the distribution system and allow for voltage regulation at the load or other selected point. The remote sense lines will carry very little current and do not need a large cross sectional area. However, the sense lines on a PCB should be located close to a ground trace or ground plane. In a discrete wiring situation, the usage of twisted pair wires or other technique for reducing noise susceptibility is recommended.

The power module will compensate for up to 0.5 V voltage drop between the sense voltage and the voltage at the power module output pins. The output voltage and the remote sense voltage offset must be less than the minimum overvoltage trip point.

If the remote sense is not needed the -Sen should be connected to -Out and +Sen should be connected to +Out.

## Current Limiting General Characteristics

All PKJ series DC/DC power modules include current limiting circuitry that makes them able to withstand continuous overloads or short circuit conditions on the output. The output voltage will decrease toward zero for heavy overloads (see product code characteristics).

The power module will resume normal operation after removal of the overload. The load distribution system should be designed to carry the maximum short circuit output current specified (see applicable code typical characteristics).

## Over Voltage Protection (OVP)

All PKJ DC/DC power modules have latching output overvoltage protection. In the event of an overvoltage condition, the power module will shut down. The power module can be restarted by cycling the input voltage.

## Turn-off Input Voltage ( $V_{Ioff}$ )

The power module monitors the input voltage and will turn on and turn off at predetermined levels.

## Output Voltage Adjust (Trim) Voltage Trimming

All PKJ series DC/DC power modules have an Output Voltage Adjust pin. This pin can be used to adjust the output voltage above or below  $V_{O1}$ . When increasing the output voltage, the voltage at the output pins (including any remote sensing offset) must be kept below the overvoltage trip point. Also note that at elevated output voltages the maximum power rating of the module remains the same, and the output current capability will decrease correspondingly.

To decrease  $V_O$  connect Radj from - SEN to Trim

To increase  $V_O$  connect Radj from + SEN to Trim

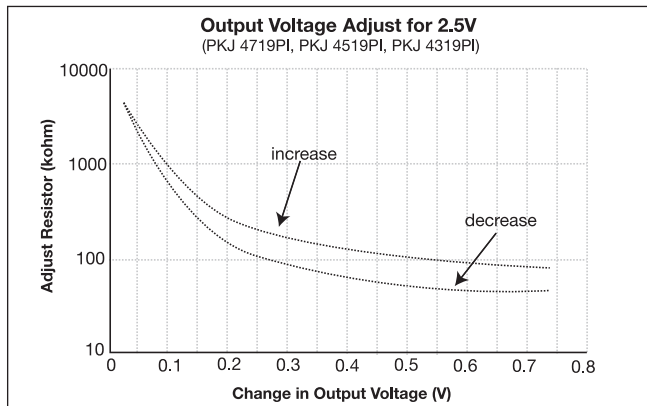

$$\text{Decrease : Radj} = (21 * V_O - 2.5) / (2.5 - V_O) \text{ k ohm}$$

$$\text{Increase : Radj} = (9.7 * V_O + 1.225) / (0.49 * V_O - 1.225) \text{ k ohm}$$

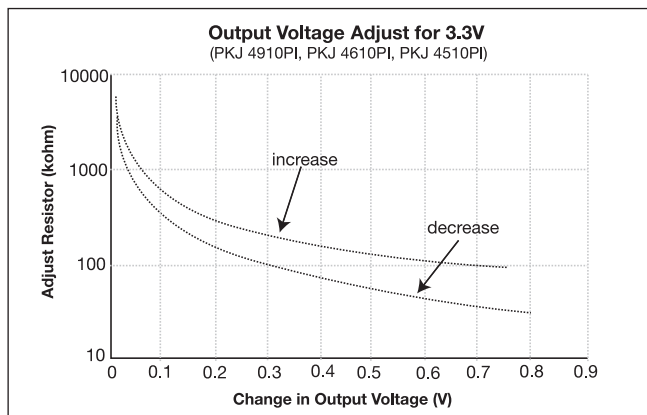

$$\text{Decrease : Radj} = (11 V_O - 3.3) / (3.3 - V_O) \text{ k ohm}$$

$$\text{Increase : Radj} = 15.94 * (V_O + 0.207) / (V_O - 3.3) \text{ k ohm}$$

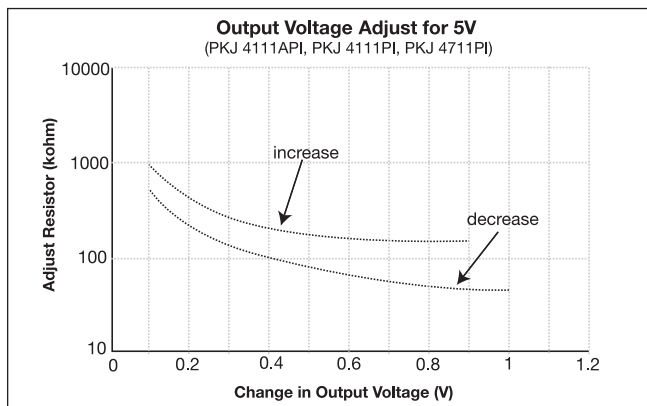

$$\text{Decrease : Radj} = (11 V_O - 4.965) / (4.965 - V_O) \text{ k ohm}$$

$$\text{Increase : Radj} = (7.286 * V_O + 1.225) / (0.2467 * V_O - 1.225) \text{ k ohm}$$

## Paralleling for Redundancy

The figure below shows how  $n + 1$  redundancy can be achieved. The diodes on the power module outputs allow a failed module to remove itself from the shared group without pulling down the common output bus. This configuration can be extended to additional numbers of power modules and they can also be controlled individually or in groups by means of signals to the primary RC inputs.

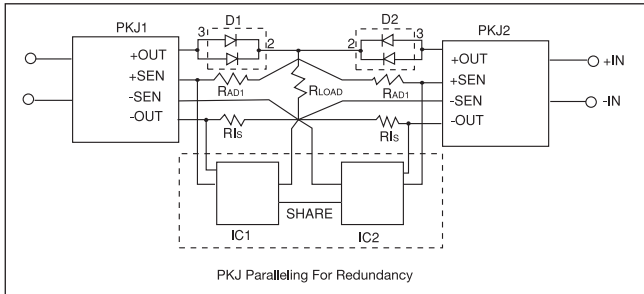

## Output Ripple & Noise ( $V_{Oac}$ )

Output ripple is measured as the peak to peak voltage from 0 to 20MHz which includes the noise voltage and fundamental.

## Over Temperature Protection

The PKJ DC/DC power modules are protected from thermal overload by an internal over temperature shutdown circuit. When the case temperature exceeds  $+110^{\circ}\text{C}$ , the power module will automatically shut down (latching). To restart the module the input voltage must be cycled. The internal temperature is a few degrees higher than the case (baseplate) temperature.

## Input and Output Impedance

The impedance of both the power source and the load will interact with the impedance of the DC/DC power module. It is most important to have the ratio between L and C as low as possible, i.e. a low characteristic impedance, both at the input and output, as the power modules have a low energy storage capability. The PKJ series of DC/DC power modules has been designed to be completely stable without the need for external capacitors on the input or output when configured with low inductance input and output circuits. The performance in some applications can be enhanced by the addition of external capacitance as described below. If the distribution of the input voltage source to the power module contains significant inductance, the addition of a 220-470  $\mu\text{F}$  capacitor across the input of the power module will help insure stability. Tantalum capacitors are not recommended due to their low ESR-value. This capacitor is not required when powering the module from a low impedance source with short, low inductance, input power leads.

## Output Capacitance

When powering loads with significant dynamic current requirements, the voltage regulation at the load can be improved by the addition of decoupling capacitance at the load. The most effective technique is to locate low ESR ceramic capacitors as close to the load as possible, using several capacitors to lower the effective ESR. These ceramic capacitors will handle the short duration high frequency components of the dynamic current requirement. In addition, higher values of electrolytic capacitors should be used to handle the mid frequency components. It is equally important to use good design practices when configuring the DC distribution system.

Low resistance and low inductance PCB (printed circuit board) layouts and cabling should be used. Remember that when using remote sensing, all the resistance, inductance and capacitance of the distribution system is within the feedback loop of the power module. This can have an effect on the modules compensation and the resulting stability and dynamic response performance.

As a rule of thumb, 100  $\mu\text{F}/\text{A}$  of output current can be used without any additional analysis. For example, with a 30A (max  $P_o$  150W) power module, values of decoupling capacitance up to 3000  $\mu\text{F}$  can be used without regard to stability. With larger values of capacitance, the load transient recovery time can exceed the specified value. As much of the capacitance as possible should be outside of the remote sensing loop and close to the load. The absolute maximum value of output capacitance is 10,000  $\mu\text{F}$ . For values larger than this contact your local Ericsson representative.

## Quality

### Reliability

The calculated MTBF of the PKJ module family is 3 million hours using Bellcore TR-332 methodology. The calculation is valid for an ambient temperature of  $40^{\circ}\text{C}$  and an output load 80% of rated maximum.

### Quality Statement

The power modules are designed and manufactured in an industrial environment where quality systems and methods like ISO 9000, 6 $\sigma$ , and SPC, are intensively in use to boost the continuous improvements strategy. Infant mortality or early failures in the products are screened out and they are subjected to an ATE-based final test. Conservative design rules, design reviews and product qualifications, plus the high competence of an engaged work force, contribute to the high quality of our products.

### Warranty

Ericsson Components warrants to the original purchaser or end user that the products conform to this Data Sheet and are free from material and workmanship defects for a period of five (5) years from the date of manufacture, if the product is used within specified conditions and not opened.

In case the product is discontinued, claims will be accepted up to three (3) years from the date of the discontinuation. For additional details on this limited warranty we refer to Ericsson Components AB's "General Terms and Conditions of Sales", EKA 950701, or individual contract documents.

### Limitation of Liability

Ericsson Components does not make any other warranties, expressed or implied including any warranty of merchantability or fitness for a particular purpose (including, but not limited to use in life support applications, where malfunctions of product can cause injury to a person's health or life).

## Product Program

$V_I$	$V_O/I_O$	$P_{Omax}$	Ordering Number
48/60 V	2.5V/30A	75W	PKJ 4719 PI
48/60 V	2.5V/20A	50W	PKJ 4519 PI
48/60 V	2.5V/15A	37.5W	PKJ 4319 PI
48/60 V	3.3V/30A	100W	PKJ 4910 PI
48/60 V	3.3V/20A	66W	PKJ 4610 PI
48/60 V	3.3V/15A	50W	PKJ 4510 PI
48/60 V	5V/30A	150W	PKJ 4111 API
48/60 V	5V/20A	100W	PKJ 4111 PI
48/60 V	5V/15A	75W	PKJ 4711 PI

To order with Optional Remote Control add P to end of ordering number for example PKJ 4719 PIP.

### Ericsson Energy Systems' Sales Offices:

<b>Brazil:</b>	Phone: +55 11 681 0040	Fax: +55 11 681 2051
<b>Denmark:</b>	Phone: +45 33 883 109	Fax: +45 33 883 105
<b>Finland:</b>	Phone: +358 9 299 4098	Fax: +358 9 299 4188
<b>France:</b>	Phone: +33 1 4083 7720	Fax: +33 1 4083 7741
<b>Germany:</b>	Phone: +49 211 534 1516	Fax: +49 211 534 1525
<b>Great Britain:</b>	Phone: +44 1793 488 300	Fax: +44 1793 488 301
<b>Hong Kong:</b>	Phone: +852 2590 2356	Fax: +852 2590 7152
<b>Italy:</b>	Phone: +39 2 7014 4203	Fax: +39 2 7014 4260
<b>Japan:</b>	Phone: +81 3 5216 9091	Fax: +81 3 5216 9096
<b>Norway:</b>	Phone: +47 66 841 906	Fax: +47 66 841 909
<b>Russia:</b>	Phone: +7 095 247 6211	Fax: +7 095 247 6212
<b>Spain:</b>	Phone: +34 91 339 1858	Fax: +34 91 339 3145
<b>Sweden:</b>	Phone: +46 8 721 6258	Fax: +46 8 721 7001
<b>United States:</b>	Phone: +1 888 853 6374	Fax: +1 972 583 7999

Information given in this data sheet is believed to be accurate and reliable. No responsibility is assumed for the consequences of its use nor for any infringement of patents or other rights of third parties which may result from its use. No license is granted by implication or otherwise under any patent or patent rights of Ericsson Components. These products are sold only according to Ericsson Components' general conditions of sale, unless otherwise confirmed in writing.  
Specifications subject to change without notice.