

# DATA SHEET

## **SAA1064** 4-digit LED-driver with I<sup>2</sup>C-Bus interface

Product specification  
File under Integrated Circuits, IC01

February 1991

4-digit LED-driver with I<sup>2</sup>C-Bus interface

SAA1064

## GENERAL DESCRIPTION

The LED-driver is a bipolar integrated circuit made in an I<sup>2</sup>L compatible 18 volts process. The circuit is especially designed to drive four 7-segment LED displays with decimal point by means of multiplexing between two pairs of digits. It features an I<sup>2</sup>C-Bus slave transceiver interface with the possibility to program four different SLAVE ADDRESSES, a POWER RESET flag, 16 current sink OUTPUTS, controllable by software up to 21 mA, two multiplex drive outputs for common anode segments, an on-chip multiplex oscillator, control bits to select static, dynamic and blank mode, and one bit for segment test.



## QUICK REFERENCE DATA

| PARAMETER                           | CONDITIONS            | SYMBOL         | MIN. | TYP. | MAX. | UNIT |
|-------------------------------------|-----------------------|----------------|------|------|------|------|
| Supply voltage                      | $V_{EE} = 0\text{ V}$ | $V_{CC}$       | 4.5  | 5    | 15   | V    |
| Supply current all outputs OFF      | $V_{CC} = 5\text{ V}$ | $I_{CC}^{(1)}$ | 7    | 9.5  | 14   | mA   |
| Total power dissipation             |                       |                |      |      |      |      |
| 24-lead DIL (SOT101B)               |                       | $P_{tot}$      | —    | —    | 1000 | mW   |
| 24-lead DIL SO (SOT137A)            |                       | $P_{tot}$      | —    | —    | 500  | mW   |
| Operating ambient temperature range |                       | $T_{amb}$      | -40  | —    | +85  | °C   |

## Note

1. The positive current is defined as the conventional current flow into a device (sink current).

## PACKAGE OUTLINE

SAA1064: 24-lead DIL; plastic with internal heat spreader (SOT101B); SOT101-1; 1996 August 30.

SAA1064T: 24-lead mini-pack; plastic (SO-24; SOT137A); SOT137-1; 1996 August 30.

4-digit LED-driver with I<sup>2</sup>C-Bus interface

SAA1064

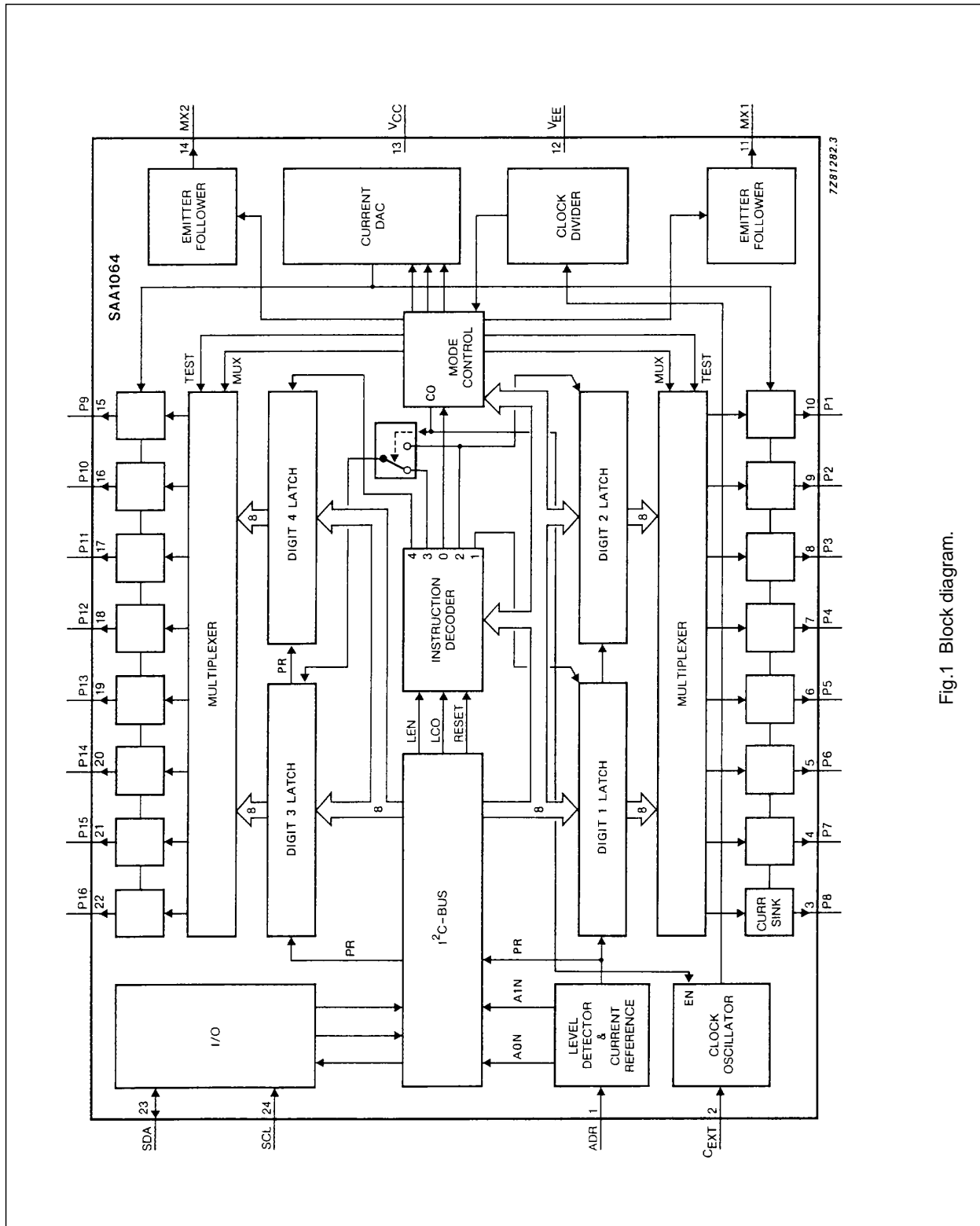

Fig.1 Block diagram.

4-digit LED-driver with I<sup>2</sup>C-Bus interface

SAA1064

## PINNING

| SYMBOL           | PIN   | DESCRIPTION                              |
|------------------|-------|--|
| ADR              | 1     | I <sup>2</sup> C-Bus slave address input |
| C <sub>EXT</sub> | 2     | external control                         |
| P8 to P1         | 3-10  | segment output                           |
| MX1              | 11    | multiplex output                         |
| V <sub>EE</sub>  | 12    | ground                                   |
| V <sub>CC</sub>  | 13    | positive supply                          |
| MX2              | 14    | multiplex output                         |
| P9 to P16        | 15-22 | segment output                           |
| SDA              | 23    | I <sup>2</sup> C-Bus serial data line    |
| SCL              | 24    | I <sup>2</sup> C-Bus serial clock line   |

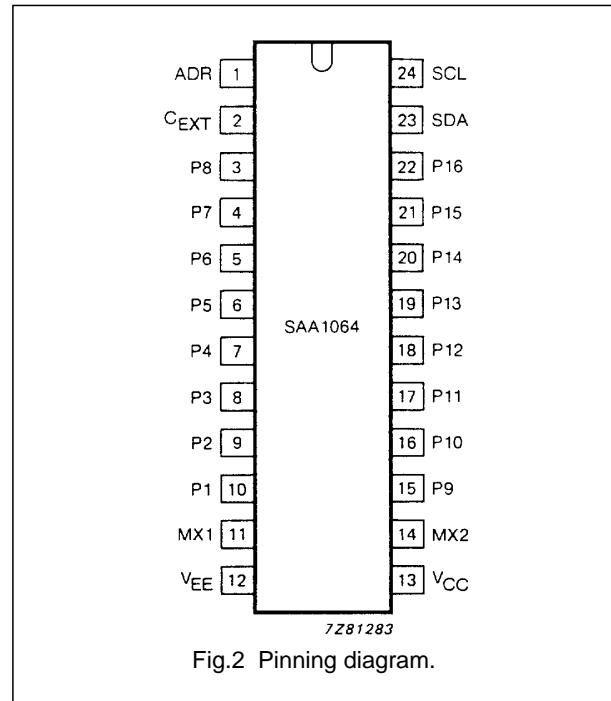

4-digit LED-driver with I<sup>2</sup>C-Bus interface

SAA1064

## FUNCTIONAL DESCRIPTION

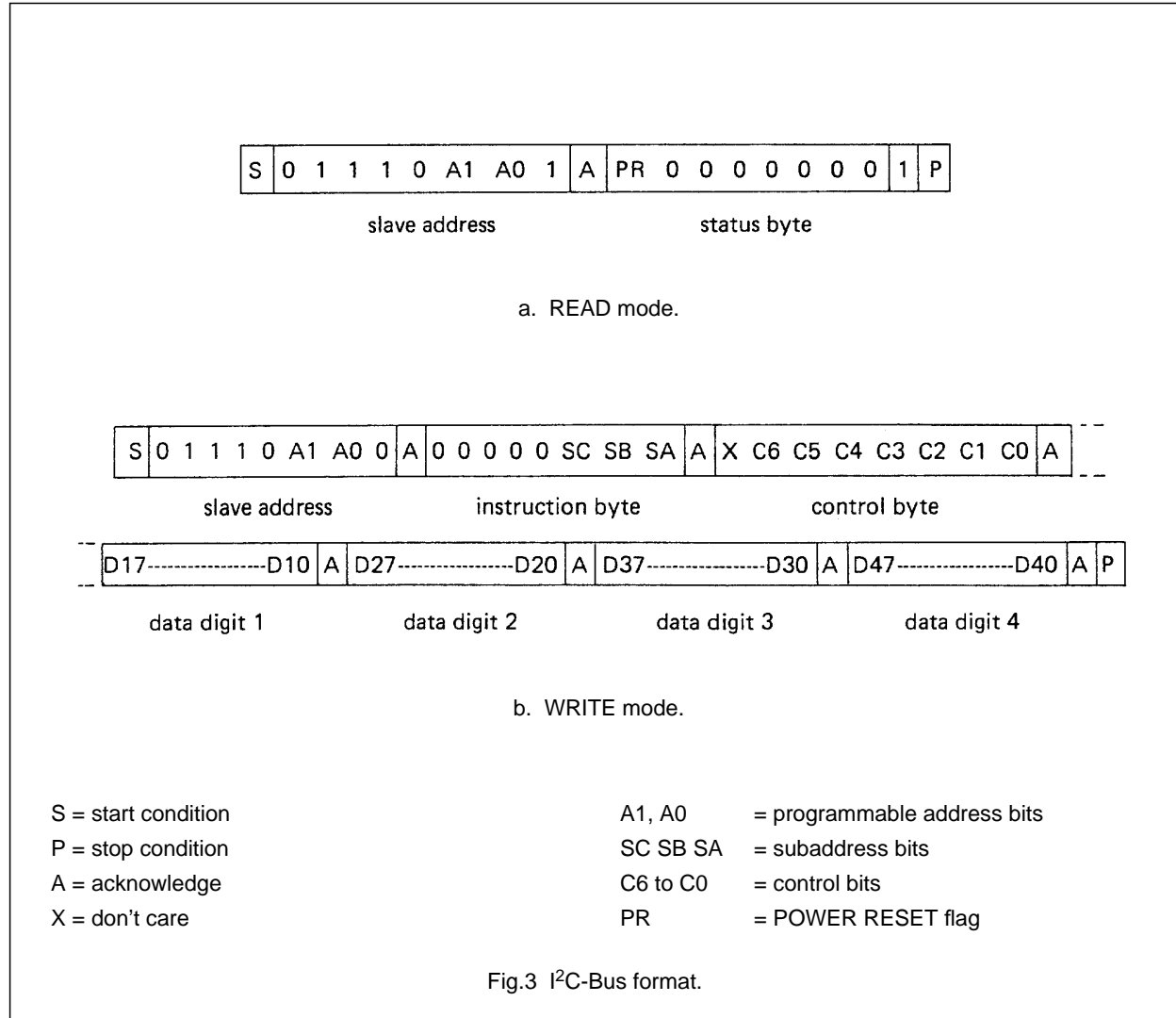
**Address pin ADR**

Four different slave addresses can be chosen by connecting ADR either to  $V_{EE}$ ,  $3/8 V_{CC}$ ,  $5/8 V_{CC}$  or  $V_{CC}$ . This results in the corresponding valid addresses HEX 70, 72, 74 and 76 for writing and 71, 73, 75 and 77 for reading. All other addresses cannot be acknowledged by the circuit.

4-digit LED-driver with I<sup>2</sup>C-Bus interface

SAA1064

**Status byte**

Only one bit is present in the status byte, the POWER RESET flag. A logic 1 indicates the occurrence of a power failure since the last time it was read out. After completion of the READ action this flag will be set to logic 0.

**Subaddressing**

The bits SC, SB and SA form a pointer and determine to which register the data byte following the instruction byte will be written. All other bytes will then be stored in the registers with consecutive subaddresses. This feature is called Auto-Increment (AI) of the subaddress and enables a quick initialization by the master.

The subaddress pointer will wrap around from 7 to 0.

The subaddresses are given as follows:

| SC | SB | SA | SUB-ADDRESS | FUNCTION           |
|----|----|----|-------------|--------------------|
| 0  | 0  | 0  | 00          | control register   |
| 0  | 0  | 1  | 01          | digit 1            |
| 0  | 1  | 0  | 02          | digit 2            |
| 0  | 1  | 1  | 03          | digit 3            |
| 1  | 0  | 0  | 04          | digit 4            |
| 1  | 0  | 1  | 05          | reserved, not used |
| 1  | 1  | 0  | 06          | reserved, not used |
| 1  | 1  | 1  | 07          | reserved, not used |

**Control bits** (see Fig.4)

The control bits C0 to C6 have the following meaning:

- C0 = 0      static mode, i.e. continuous display of digits 1 and 2
- C0 = 1      dynamic mode, i.e. alternating display of digit 1 + 3 and 2 + 4
- C1 = 0/1    digits 1 + 3 are blanked/not blanked
- C2 = 0/1    digits 2 + 4 are blanked/not blanked
- C3 = 1      all segment outputs are switched-on for segment test<sup>(1)</sup>
- C4 = 1      adds 3 mA to segment output current
- C5 = 1      adds 6 mA to segment output current
- C6 = 1      adds 12 mA to segment output current

**Note**

1. At a current determined by C4, C5 and C6.

**Data**

A segment is switched ON if the corresponding data bit is logic 1. Data bits D17 to D10 correspond with digit 1, D27 to D20 with digit 2, D37 to D30 with digit 3 and D47 to D40 with digit 4.

The MSBs correspond with the outputs P8 and P16, the LSBs with P1 and P9. Digit numbers 1 to 4 are equal to their subaddresses (hex) 1 to 4.

---

## 4-digit LED-driver with I<sup>2</sup>C-Bus interface

## SAA1064

---

### SDA, SCL

The SDA and SCL I/O meet the I<sup>2</sup>C-Bus specification. For protection against positive voltage pulses on these inputs voltage regulator diodes are connected to V<sub>EE</sub>. This means that normal line voltage should not exceed 5,5 volt. Data will be latched on the positive-going edge of the acknowledge related clock pulse.

### Power-on reset

The power-on reset signal is generated internally and sets all bits to zero, resulting in a completely blanked display. Only the POWER RESET flag is set.

### External Control (C<sub>EXT</sub>)

With a capacitor connected to pin 2 the multiplex frequency can be set (see Fig.5). When static this pin can be connected to V<sub>EE</sub> or V<sub>CC</sub> or left floating since the oscillator will be switched off.

### Segment outputs

The segment outputs P1 to P16 are controllable current-sink sources. They are switched on by the corresponding data bits and their current is adjusted by control bits C4, C5 and C6.

### Multiplex outputs

The multiplex outputs MX1 and MX2 are switched alternately in dynamic mode with a frequency derived from the clock-oscillator. In static mode MX1 is switched on. The outputs consist of an emitter-follower, which can be used to drive the common anodes of two displays directly provided that the total power dissipation of the circuit is not exceeded. If this occurs external transistors should be connected to pins 11 and 14 as shown in Fig.5.

4-digit LED-driver with I<sup>2</sup>C-Bus interface

SAA1064

**RATINGS**

Limiting values in accordance with the Absolute Maximum System (IEC 134)

| PARAMETER                     | CONDITIONS             | SYMBOL                | MIN. | MAX.           | UNIT |
|-------------------------------|------------------------|-----------------------|------|----------------|------|
| Supply voltage (pin 13)       | $V_{EE} = 0 \text{ V}$ | $V_{CC}$              | -0.5 | 18             | V    |
| Supply current (pin 13)       |                        | $I_{CC}$              | -50  | 200            | mA   |
| Total power dissipation       |                        |                       |      |                |      |
| 24-lead DIL (SOT101B)         |                        | $P_{tot}$             |      | 1000           | mW   |
| 24-lead SO (SO137A)           |                        | $P_{tot}$             |      | 500            | mW   |
| SDA, SCL voltages             | $V_{EE} = 0 \text{ V}$ | $V_{23, 24}$          | -0.5 | 5.9            | V    |
| Voltages ADR-MX1 and MX2-P16  | $V_{EE} = 0 \text{ V}$ | $V_{1-11}, V_{14-22}$ | -0.5 | $V_{CC} + 0.5$ | V    |
| Input/output current all pins | outputs OFF            | $\pm I_{I/O}$         | -    | 10             | mA   |
| Operating ambient             |                        |                       |      |                |      |
| temperature range             |                        | $T_{amb}$             | -40  | +85            | °C   |
| Storage temperature range     |                        | $T_{stg}$             | -55  | +150           | °C   |

**THERMAL RESISTANCE**

From crystal to ambient

|                                       |               |         |
|---------------------------------------|---------------|---------|
| 24-lead DIL                           | $R_{th\ j-a}$ | 35 K/W  |
| 24-lead SO (on ceramic substrate)     | $R_{th\ j-a}$ | 75 K/W  |
| 24-lead SO (on printed circuit board) | $R_{th\ j-a}$ | 105 K/W |



4-digit LED-driver with I<sup>2</sup>C-Bus interface

SAA1064

**CHARACTERISTICS**V<sub>CC</sub> = 5 V; T<sub>amb</sub> = 25 °C; voltages are referenced to ground (V<sub>EE</sub> = 0 V); unless otherwise specified

| PARAMETER                                       | CONDITIONS                           | SYMBOL             | MIN.                 | TYP.               | MAX.                 | UNIT |
|---|--------------------------------------|--------------------|----------------------|--------------------|----------------------|------|
| <b>Supply</b>                                   |                                      |                    |                      |                    |                      |      |
| Supply voltage (pin 13)                         |                                      | V <sub>CC</sub>    | 4,5                  | 5,0                | 15                   | V    |
| Supply current                                  | all outputs OFF                      |                    |                      |                    |                      |      |
|   | V <sub>CC</sub> = 5 V                | I <sub>CC</sub>    | 7,0                  | 9,5                | 14,0                 | mA   |
| Power dissipation                               | all outputs OFF                      | P <sub>d</sub>     | –                    | 50                 | –                    | mW   |
| <b>SDA; SCL (pins 23 and 24)</b>                |                                      |                    |                      |                    |                      |      |
| Input voltages                                  |                                      | V <sub>23,24</sub> | 0                    | –                  | 5,5                  | V    |
| Logic input voltage LOW                         |                                      | V <sub>IL(L)</sub> | –                    | –                  | 1,5                  | V    |
| Logic input voltage HIGH                        |                                      | V <sub>IH(L)</sub> | 3,0                  | –                  | –                    | V    |
| Input current LOW                               | V <sub>23,24</sub> = V <sub>EE</sub> | –I <sub>IL</sub>   | –                    | –                  | 10                   | μA   |
| Input current HIGH                              | V <sub>23,24</sub> = V <sub>CC</sub> | I <sub>IH</sub>    | –                    | –                  | 10                   | μA   |
| <b>SDA</b>                                      |                                      |                    |                      |                    |                      |      |
| Logic output voltage LOW                        | I <sub>O</sub> = 3 mA                | V <sub>OL(L)</sub> | –                    | –                  | 0,4                  | V    |
| Output sink current                             |                                      | I <sub>SDA</sub>   | 3                    | –                  | –                    | mA   |
| <b>Address input (pin 1)</b>                    |                                      |                    |                      |                    |                      |      |
| Input voltage                                   |                                      |                    |                      |                    |                      |      |
| programmable address bits:                      |                                      |                    |                      |                    |                      |      |
| A0 = 0; A1 = 0                                  |                                      | V <sub>1</sub>     | V <sub>EE</sub>      | –                  | 3/16V <sub>CC</sub>  | V    |
| A0 = 1; A1 = 0                                  |                                      | V <sub>1</sub>     | 5/16V <sub>CC</sub>  | 3/8V <sub>CC</sub> | 7/16V <sub>CC</sub>  | V    |
| A0 = 0; A1 = 1                                  |                                      | V <sub>1</sub>     | 9/16V <sub>CC</sub>  | 5/8V <sub>CC</sub> | 11/16V <sub>CC</sub> | V    |
| A0 = 1; A1 = 1                                  |                                      | V <sub>1</sub>     | 13/16V <sub>CC</sub> | –                  | V <sub>CC</sub>      | V    |
| Input current LOW                               | V <sub>1</sub> = V <sub>EE</sub>     | –I <sub>1</sub>    | –                    | –                  | 10                   | μA   |
| Input current HIGH                              | V <sub>1</sub> = V <sub>CC</sub>     | I <sub>1</sub>     | –                    | –                  | 10                   | μA   |
| <b>External control (C<sub>EXT</sub>) pin 2</b> |                                      |                    |                      |                    |                      |      |
| <b>Switching level input</b>                    |                                      |                    |                      |                    |                      |      |
| Input voltage LOW                               |                                      | V <sub>IL</sub>    | –                    | –                  | V <sub>CC</sub> –3,3 | V    |
| Input voltage HIGH                              |                                      | V <sub>IH</sub>    | V <sub>CC</sub> –1,5 | –                  | –                    | V    |
| Input current                                   | V <sub>2</sub> = 2 V                 | I <sub>2</sub>     | –140                 | –160               | –180                 | μA   |
|   | V <sub>2</sub> = 4 V                 | I <sub>2</sub>     | 140                  | 160                | 180                  | μA   |

4-digit LED-driver with I<sup>2</sup>C-Bus interface

SAA1064

| PARAMETER                                       | CONDITIONS                    | SYMBOL       | MIN.         | TYP. | MAX.     | UNIT          |
|---|-------------------------------|--------------|--------------|------|----------|---------------|
| <b>Segment outputs</b>                          |                               |              |              |      |          |               |
| (P8 to P1; pins 3 to 10)                        |                               |              |              |      |          |               |
| P9 to P16; pins 15 to 22)                       |                               |              |              |      |          |               |
| Output voltages                                 | $I_O = 15 \text{ mA}$         | $V_O$        | –            | –    | 0.5      | V             |
| Output leakage current HIGH                     | $V_O = V_{CC} = 15 \text{ V}$ | $I_{LO}$     | –            | –    | $\pm 10$ | $\mu\text{A}$ |
| Output current LOW                              |                               |              |              |      |          |               |
| All control bits (C4, C5 and C6) are HIGH       | $V_{OL} = 5 \text{ V}$        | $I_{OL}$     | 17.85        | 21   | 25.2     | mA            |
| Contribution of:                                |                               |              |              |      |          |               |
| control bit C4                                  |                               | $I_O$        | 2.55         | 3.0  | 3.6      | mA            |
| control bit C5                                  |                               | $I_O$        | 5.1          | 6.0  | 7.2      | mA            |
| control bit C6                                  |                               | $I_O$        | 10.2         | 12.0 | 14.4     | mA            |
| <b>Relative segment output current accuracy</b> |                               |              |              |      |          |               |
| with respect to highest value                   |                               | $\Delta I_O$ | –            | –    | 7.5      | %             |
| <b>Multiplex 1 and 2 (pins 11 and 14)</b>       |                               |              |              |      |          |               |
| Maximum output voltage (when ON)                | $-I_{MPX} = 50 \text{ mA}$    | $V_{MPX}$    | $V_{CC}-1.5$ | –    | –        | V             |
| Maximum output current HIGH (when ON)           | $V_{MPX} = 2 \text{ V}$       | $-I_{MPX}$   | 50           | –    | 110      | mA            |
| Maximum output current LOW (when OFF)           | $V_O = 2 \text{ V}$           | $+I_{MPX}$   | 50           | 70   | 110      | $\mu\text{A}$ |
| Multiplex output period                         | $C_{EXT} = 2.7 \text{ nF}$    | $T_{MPX}$    | 5            | –    | 10       | ms            |
| Multiplexed duty factor                         |                               |              | –            | 48.4 | –        | %             |

\* Value to be fixed.

4-digit LED-driver with I<sup>2</sup>C-Bus interface

SAA1064

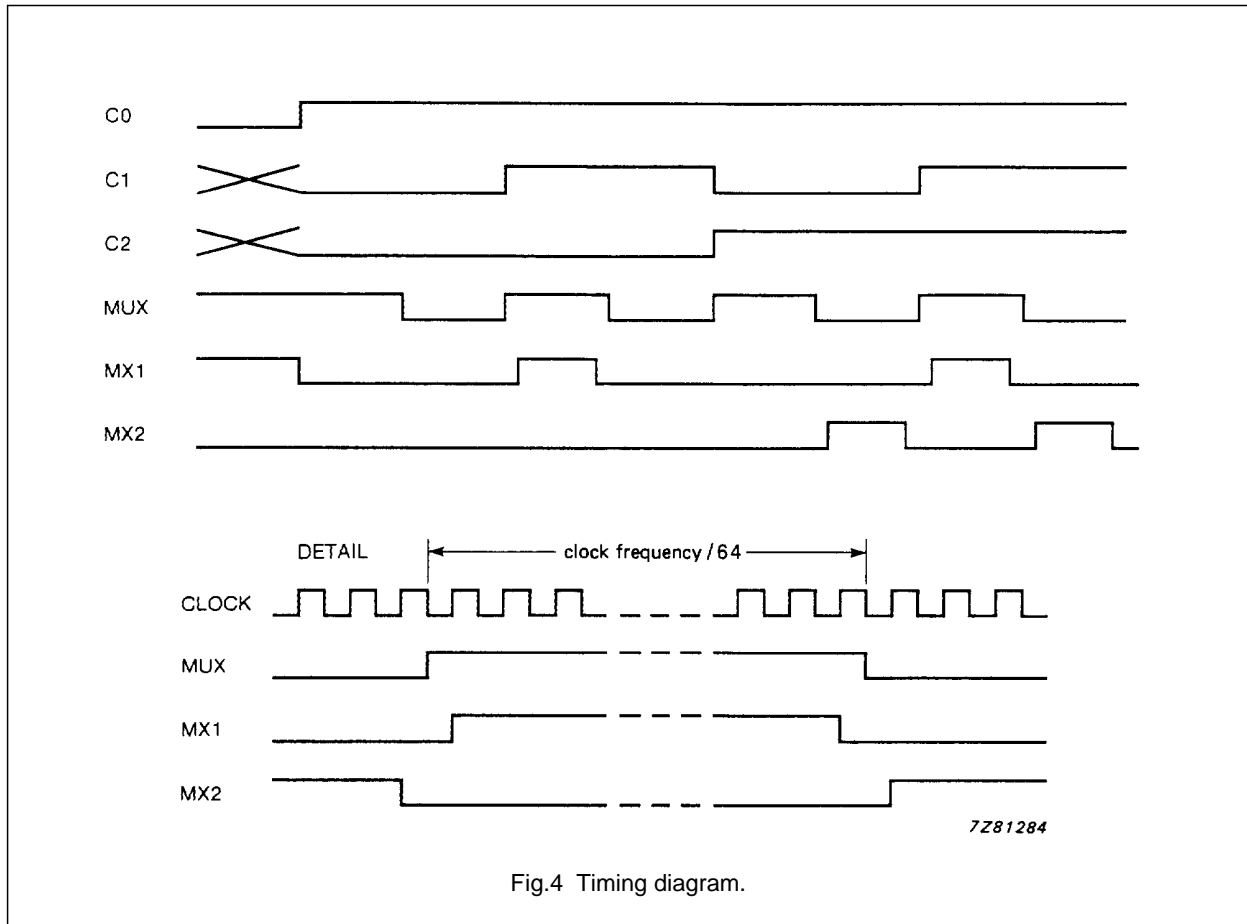

Fig.4 Timing diagram.

4-digit LED-driver with I<sup>2</sup>C-Bus interface

SAA1064

APPLICATION INFORMATION

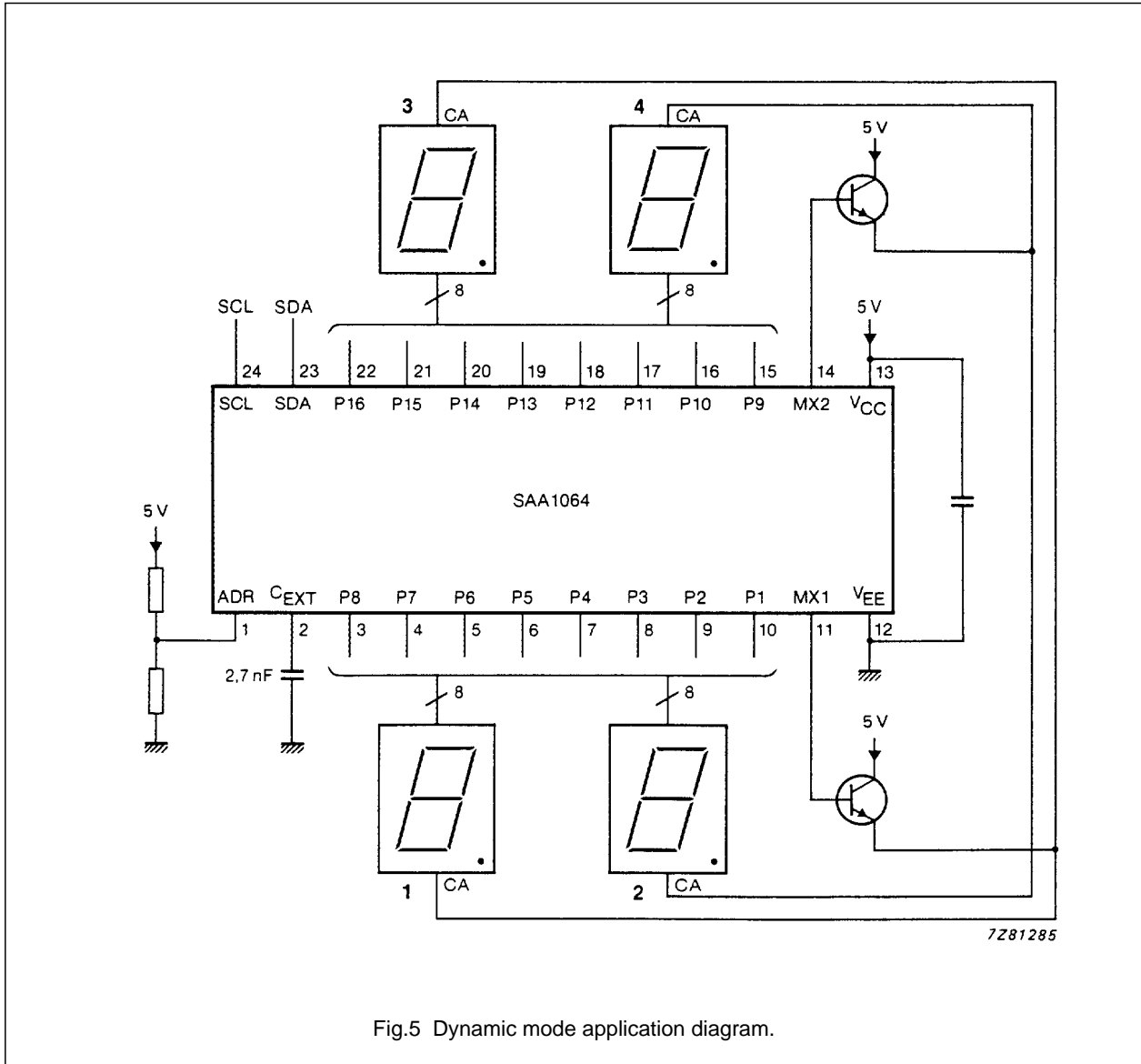

Fig.5 Dynamic mode application diagram.

4-digit LED-driver with I<sup>2</sup>C-Bus interface

SAA1064

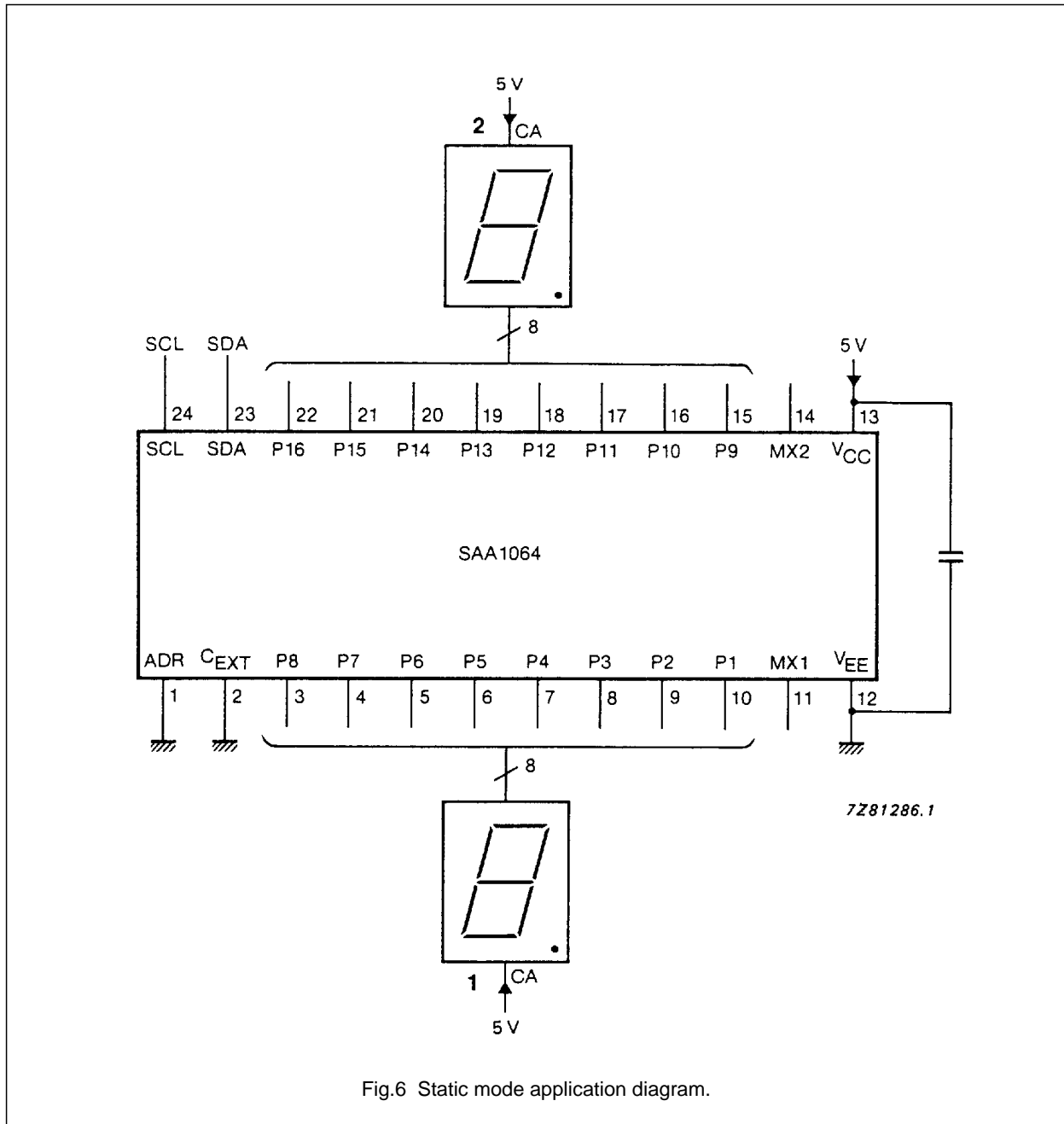

Fig.6 Static mode application diagram.

4-digit LED-driver with I<sup>2</sup>C-Bus interface

SAA1064

**POWER DISSIPATION**

The total maximum power dissipation of the SAA1064 is made up by the following parts:

1. Maximum dissipation when none of the outputs are programmed (continuous line in Fig.7).
2. Maximum dissipation of each programmed output. The dashed line in Fig.7 visualises the dissipation when **all** the segments are programmed (max. 16 in the static, and max. 32 in the dynamic mode). When less segments are programmed one should take a proportional part of the maximum value.
3. Maximum dissipation of the programmed segment drivers which can be expressed as:  

$$P_{\text{add}} = V_{\text{O}} \times I_{\text{O}} \times N.$$

Where:

- $P_{\text{add}}$  = The additional power dissipation of the segment drivers
- $V_{\text{O}}$  = The low state segment driver output voltage
- $I_{\text{O}}$  = The programmed segment output current
- $N$  = The number of programmed segments in the static mode, or half the number of programmed segment drivers in the dynamic mode.

Under no conditions the total maximum dissipation (500 mW for the SO and 1000 mW for the DIL package) should be exceeded.

**Example:**

- $V_{\text{CC}} = 5 \text{ V}$
- $V_{\text{O}} = 0.25 \text{ V}$
- $I_{\text{O}} = 12 \text{ mA}$
- 24 programmed segments in dynamic mode
- $P_{\text{tot}} = P_1 + P_2 + P_3$
- $= 75 \text{ mW} + (50 * 24/32) \text{ mW} + (0.25 * 12 \cdot 10^{-3} * 12) \text{ mW}$
- $= 148.5 \text{ mW}$

4-digit LED-driver with I<sup>2</sup>C-Bus interface

SAA1064

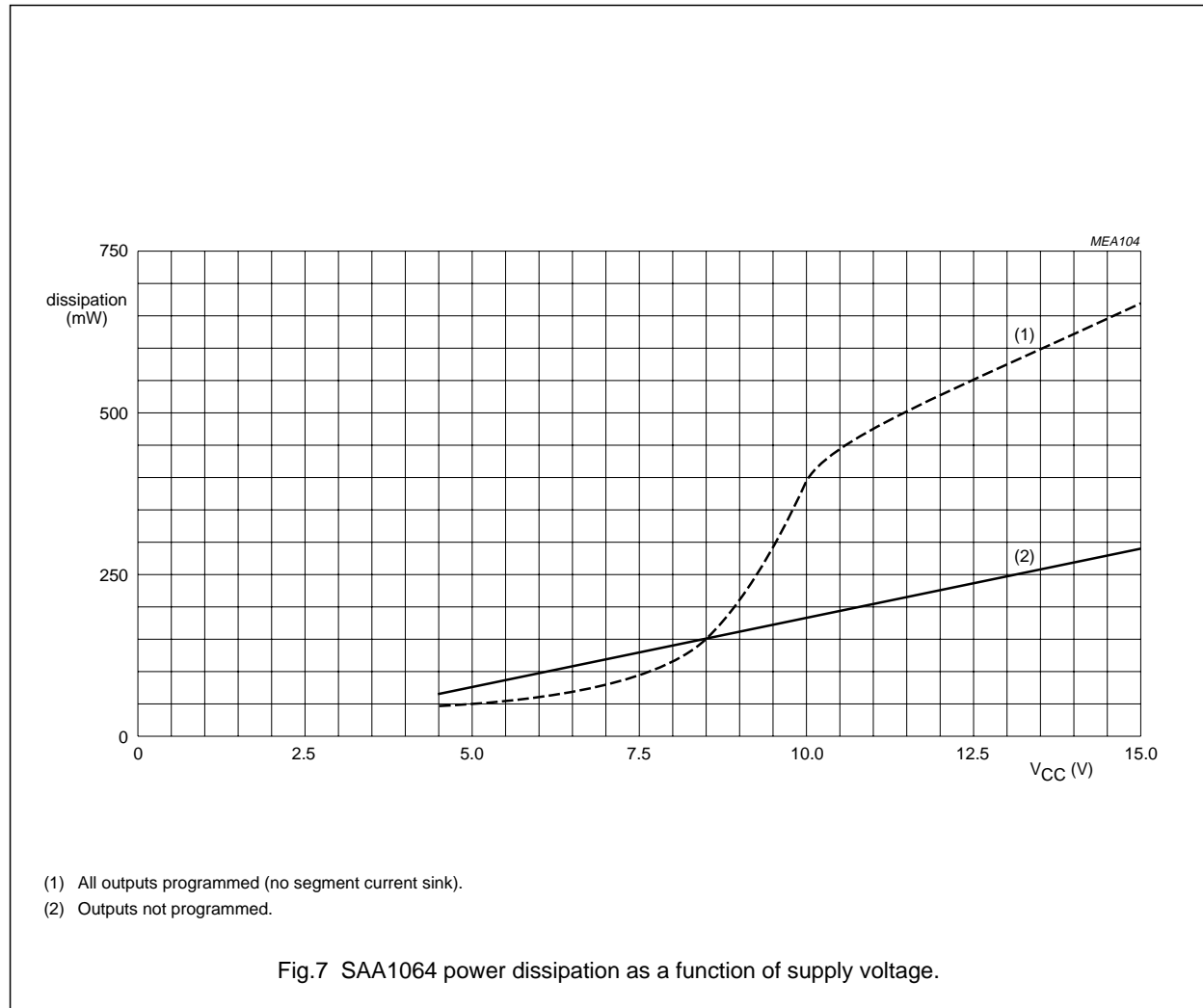

4-digit LED-driver with I<sup>2</sup>C-Bus interface

SAA1064

PACKAGE OUTLINES

DIP24: plastic dual in-line package; 24 leads (600 mil)

SOT101-1

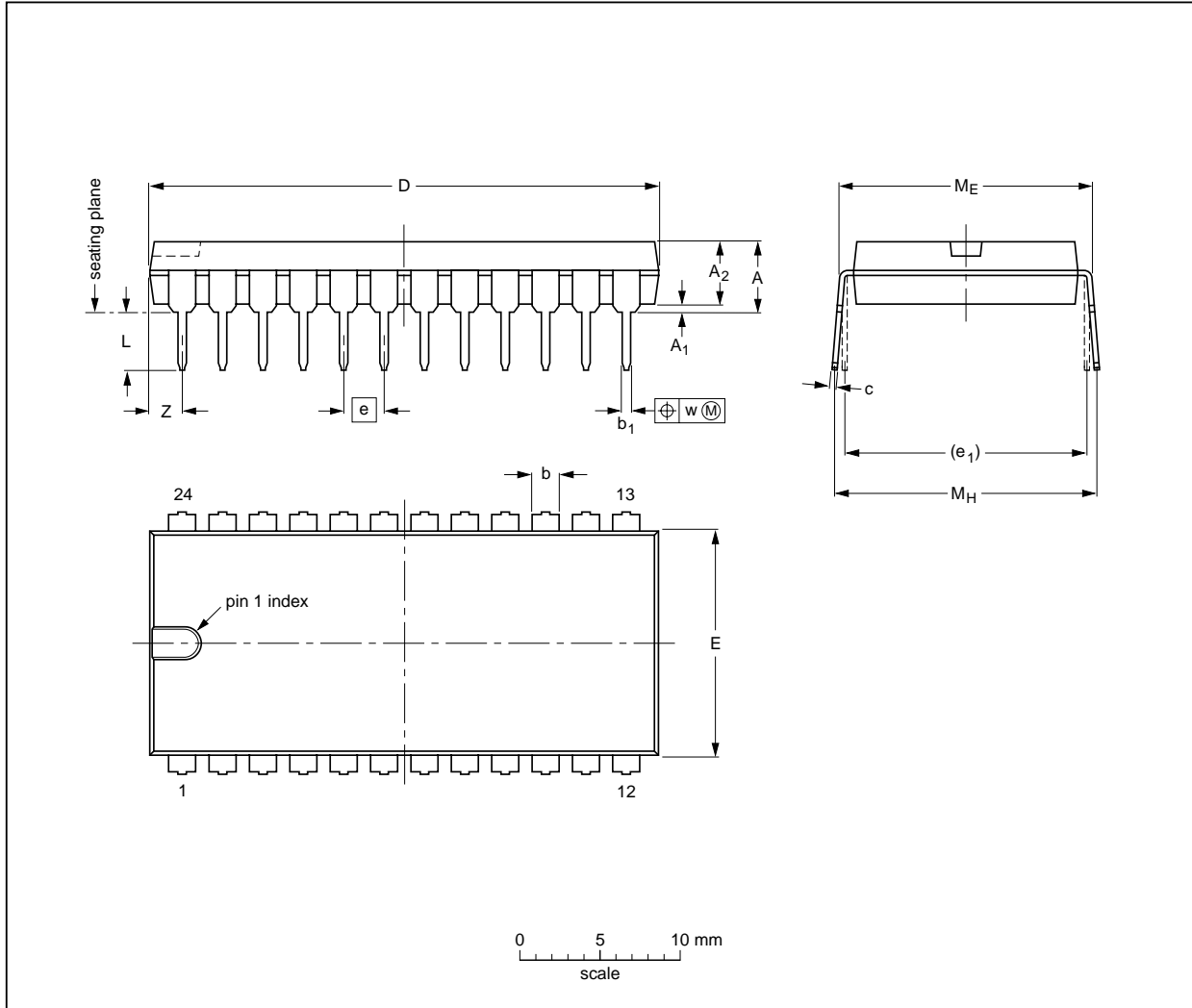

DIMENSIONS (inch dimensions are derived from the original mm dimensions)

| UNIT   | A max. | A <sub>1</sub> min. | A <sub>2</sub> max. | b              | b <sub>1</sub> | c              | D <sup>(1)</sup> | E <sup>(1)</sup> | e    | e <sub>1</sub> | L            | M <sub>E</sub> | M <sub>H</sub> | w    | Z <sup>(1)</sup> max. |
|--------|--------|---------------------|---------------------|----------------|----------------|----------------|------------------|------------------|------|----------------|--------------|----------------|----------------|------|-----------------------|
| mm     | 5.1    | 0.51                | 4.0                 | 1.7<br>1.3     | 0.53<br>0.38   | 0.32<br>0.23   | 32.0<br>31.4     | 14.1<br>13.7     | 2.54 | 15.24          | 3.9<br>3.4   | 15.80<br>15.24 | 17.15<br>15.90 | 0.25 | 2.2                   |
| inches | 0.20   | 0.020               | 0.16                | 0.066<br>0.051 | 0.021<br>0.015 | 0.013<br>0.009 | 1.26<br>1.24     | 0.56<br>0.54     | 0.10 | 0.60           | 0.15<br>0.13 | 0.62<br>0.60   | 0.68<br>0.63   | 0.01 | 0.087                 |

Note

1. Plastic or metal protrusions of 0.25 mm maximum per side are not included.

| OUTLINE VERSION | REFERENCES |          |      |  | EUROPEAN PROJECTION | ISSUE DATE           |
|-----------------|------------|----------|------|--|---------------------|----------------------|
|                 | IEC        | JEDEC    | EIAJ |  |                     |                      |
| SOT101-1        | 051G02     | MO-015AD |      |  |                     | 92-11-17<br>95-01-23 |



4-digit LED-driver with I<sup>2</sup>C-Bus interface

SAA1064

SO24: plastic small outline package; 24 leads; body width 7.5 mm

SOT137-1

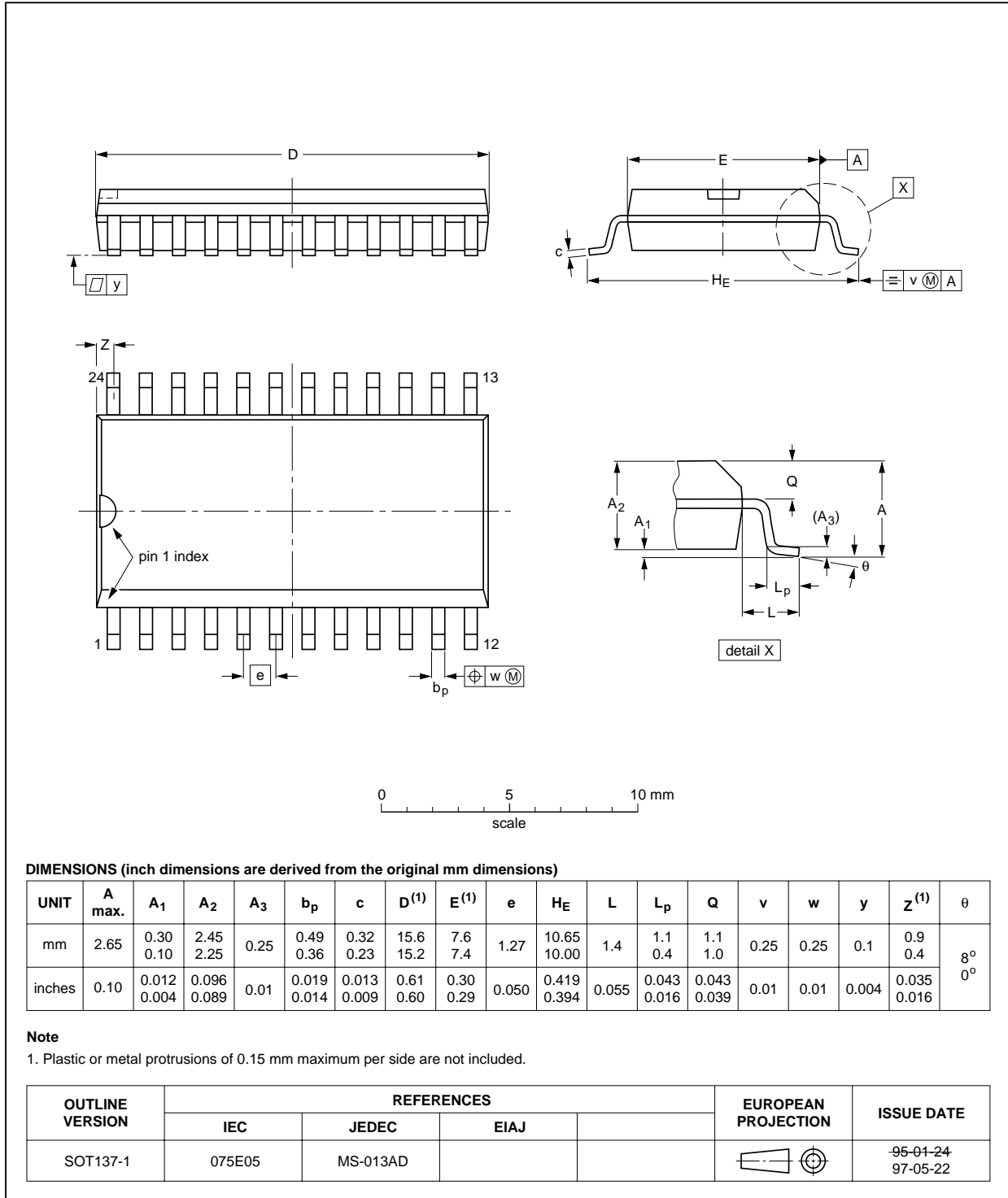

## 4-digit LED-driver with I<sup>2</sup>C-Bus interface

SAA1064

### SOLDERING

#### Introduction

There is no soldering method that is ideal for all IC packages. Wave soldering is often preferred when through-hole and surface mounted components are mixed on one printed-circuit board. However, wave soldering is not always suitable for surface mounted ICs, or for printed-circuits with high population densities. In these situations reflow soldering is often used.

This text gives a very brief insight to a complex technology. A more in-depth account of soldering ICs can be found in our *"IC Package Databook"* (order code 9398 652 90011).

#### DIP

##### SOLDERING BY DIPPING OR BY WAVE

The maximum permissible temperature of the solder is 260 °C; solder at this temperature must not be in contact with the joint for more than 5 seconds. The total contact time of successive solder waves must not exceed 5 seconds.

The device may be mounted up to the seating plane, but the temperature of the plastic body must not exceed the specified maximum storage temperature ( $T_{stg\ max}$ ). If the printed-circuit board has been pre-heated, forced cooling may be necessary immediately after soldering to keep the temperature within the permissible limit.

##### REPAIRING SOLDERED JOINTS

Apply a low voltage soldering iron (less than 24 V) to the lead(s) of the package, below the seating plane or not more than 2 mm above it. If the temperature of the soldering iron bit is less than 300 °C it may remain in contact for up to 10 seconds. If the bit temperature is between 300 and 400 °C, contact may be up to 5 seconds.

#### SO

##### REFLOW SOLDERING

Reflow soldering techniques are suitable for all SO packages.

Reflow soldering requires solder paste (a suspension of fine solder particles, flux and binding agent) to be applied to the printed-circuit board by screen printing, stencilling or pressure-syringe dispensing before package placement.

Several techniques exist for reflowing; for example, thermal conduction by heated belt. Dwell times vary between 50 and 300 seconds depending on heating method. Typical reflow temperatures range from 215 to 250 °C.

Preheating is necessary to dry the paste and evaporate the binding agent. Preheating duration: 45 minutes at 45 °C.

##### WAVE SOLDERING

Wave soldering techniques can be used for all SO packages if the following conditions are observed:

- A double-wave (a turbulent wave with high upward pressure followed by a smooth laminar wave) soldering technique should be used.
- The longitudinal axis of the package footprint must be parallel to the solder flow.
- The package footprint must incorporate solder thieves at the downstream end.

During placement and before soldering, the package must be fixed with a droplet of adhesive. The adhesive can be applied by screen printing, pin transfer or syringe dispensing. The package can be soldered after the adhesive is cured.

Maximum permissible solder temperature is 260 °C, and maximum duration of package immersion in solder is 10 seconds, if cooled to less than 150 °C within 6 seconds. Typical dwell time is 4 seconds at 250 °C.

A mildly-activated flux will eliminate the need for removal of corrosive residues in most applications.

##### REPAIRING SOLDERED JOINTS

Fix the component by first soldering two diagonally-opposite end leads. Use only a low voltage soldering iron (less than 24 V) applied to the flat part of the lead. Contact time must be limited to 10 seconds at up to 300 °C. When using a dedicated tool, all other leads can be soldered in one operation within 2 to 5 seconds between 270 and 320 °C.

4-digit LED-driver with I<sup>2</sup>C-Bus interface

SAA1064

**DEFINITIONS**

|   |   |
|---|---|
| <b>Data sheet status</b>  |   |
| Objective specification   | This data sheet contains target or goal specifications for product development.       |
| Preliminary specification   | This data sheet contains preliminary data; supplementary data may be published later. |
| Product specification   | This data sheet contains final product specifications.                                |
| <b>Limiting values</b>  |   |
| Limiting values given are in accordance with the Absolute Maximum Rating System (IEC 134). Stress above one or more of the limiting values may cause permanent damage to the device. These are stress ratings only and operation of the device at these or at any other conditions above those given in the Characteristics sections of the specification is not implied. Exposure to limiting values for extended periods may affect device reliability. |   |
| <b>Application information</b>  |   |
| Where application information is given, it is advisory and does not form part of the specification.   |   |

**LIFE SUPPORT APPLICATIONS**

These products are not designed for use in life support appliances, devices, or systems where malfunction of these products can reasonably be expected to result in personal injury. Philips customers using or selling these products for use in such applications do so at their own risk and agree to fully indemnify Philips for any damages resulting from such improper use or sale.

**PURCHASE OF PHILIPS I<sup>2</sup>C COMPONENTS**

Purchase of Philips I<sup>2</sup>C components conveys a license under the Philips' I<sup>2</sup>C patent to use the components in the I<sup>2</sup>C system provided the system conforms to the I<sup>2</sup>C specification defined by Philips. This specification can be ordered using the code 9398 393 40011.