

Low Noise, Cascadable Silicon Bipolar MMIC Amplifier

Technical Data

INA-10386

Features

- **Cascadable 50 Ω Gain Block**
- **3 dB Bandwidth:**
DC to 1.8 GHz
- **26 dB Typical Gain at
1.5 GHz**
- **10 dBm Typical P_{1dB} at
1.5 GHz**
- **Unconditionally Stable
(k>1)**
- **Surface Mount Plastic
Package**

Description

The INA-10386 is a low-noise silicon bipolar Monolithic Microwave Integrated Circuit (MMIC)

feedback amplifier housed in a low cost surface mount plastic package. It is designed for narrow or wide bandwidth commercial and industrial applications that require high gain and moderate power.

The INA series of MMICs is fabricated using HP's 10 GHz f_T , 25 GHz f_{MAX} , ISOSAT™-I silicon bipolar process which uses nitride self-alignment, submicrometer lithography, trench isolation, ion implantation, gold metallization and polyimide intermetal dielectric and scratch protection to achieve excellent performance, uniformity and reliability.

86 Plastic Package

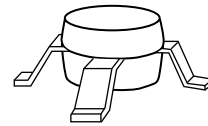

Typical Biasing Configuration

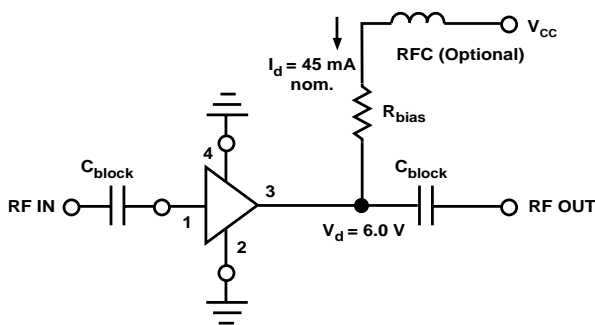

INA-10386 Absolute Maximum Ratings

Parameter	Absolute Maximum ^[1]
Device Current	80 mA
Power Dissipation ^[2,3]	750 mW
RF Input Power	+13 dBm
Junction Temperature	150°C
Storage Temperature	-65 to 150°C

Thermal Resistance:

$$\theta_{jc} = 100^{\circ}\text{C}/\text{W}$$

Notes:

1. Permanent damage may occur if any of these limits are exceeded.
2. $T_{\text{CASE}} = 25^{\circ}\text{C}$.
3. Derate at 10 mW/°C for $T_{\text{C}} > 75^{\circ}\text{C}$.

INA-10386 Electrical Specifications^[1], $T_{\text{A}} = 25^{\circ}\text{C}$

Symbol	Parameters and Test Conditions: $V_{\text{d}} = 6\text{V}$, $Z_{\text{o}} = 50 \Omega$	Units	Min.	Typ.	Max.
G_{P}	Power Gain ($ S_{21} ^2$) $f = 1.5 \text{ GHz}$	dB	23.0	26.0	
ΔG_{P}	Gain Flatness $f = 0.1 \text{ to } 1.5 \text{ GHz}$	dB		± 1.0	
$f_{3 \text{ dB}}$	3 dB Bandwidth ^[2]	GHz		1.8	
ISO	Reverse Isolation ($ S_{12} ^2$) $f = 2.0 \text{ GHz}$	dB		30	
VSWR	Input VSWR $f = 0.1 \text{ to } 2.0 \text{ GHz}$			1.5:1	
	Output VSWR $f = 0.1 \text{ to } 2.0 \text{ GHz}$			1.5:1	
NF	50 Ω Noise Figure $f = 1.5 \text{ GHz}$	dB		3.8	
$P_{1 \text{ dB}}$	Output Power at 1 dB Gain Compression $f = 1.5 \text{ GHz}$	dBm		10	
IP_3	Third Order Intercept Point $f = 1.5 \text{ GHz}$	dBm		23	
t_{D}	Group Delay $f = 1.5 \text{ GHz}$	psec		250	
I_{d}	Device Current	mA	35	45	55
dV/dT	Device Voltage Temperature Coefficient	mV/°C		+10	

Notes:

1. The recommended operating current range for this device is 40 to 60 mA. Typical performance as a function of current is on the following page.

INA-10386 Part Number Ordering Information

Part Number	No. of Devices	Container
INA-10386-TR1	1000	7" Reel
INA-10386-BLK	100	Antistatic Bag

INA-10386 Typical Scattering Parameters ($Z_o = 50 \Omega$, $T_A = 25^\circ\text{C}$, $V_d = 6 \text{ V}$)

Freq. GHz	S_{11}		S_{21}			S_{12}			S_{22}		k
	Mag	Ang	dB	Mag	Ang	dB	Mag	Ang	Mag	Ang	
0.05	.12	-9	26.6	21.4	-4	-35.2	.017	1	.11	-3	1.51
0.10	.11	-17	26.7	21.6	-8	-35.6	.017	3	.12	-10	1.50
0.50	.13	-79	26.7	21.6	-38	-35.7	.016	10	.07	-40	1.59
1.00	.17	-137	26.8	21.9	-80	-34.1	.020	43	.03	18	1.33
1.50	.21	171	26.0	20.0	-126	-33.1	.023	53	.07	32	1.26
2.00	.21	127	23.6	15.1	-168	-29.9	.032	55	.07	9	1.23
2.50	.19	106	21.7	12.2	159	-28.4	.038	58	.04	42	1.27
3.00	.14	86	19.2	9.1	127	-26.7	.048	55	.05	56	1.37
3.50	.07	85	16.8	6.9	97	-24.8	.058	50	.06	47	1.44
4.00	.08	148	14.2	5.1	70	-24.7	.058	51	.04	40	1.82

INA-10386 Typical Performance, $T_A = 25^\circ\text{C}$

(unless otherwise noted)

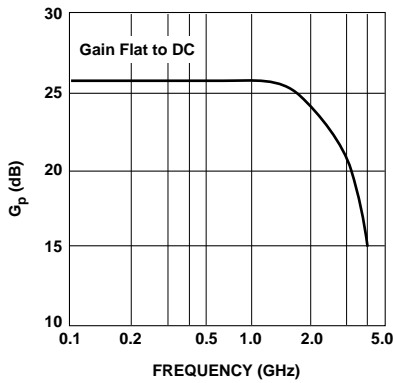

Figure 1. Typical Gain and Noise Figure vs. Frequency, $T_A = 25^\circ\text{C}$, $V_d = 6 \text{ V}$.

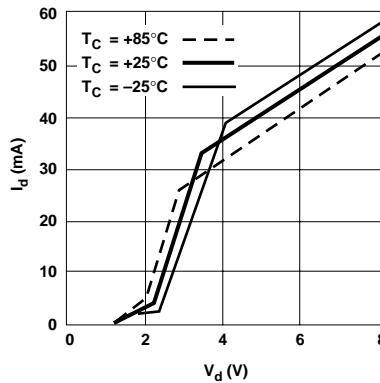

Figure 2. Device Current vs. Voltage.

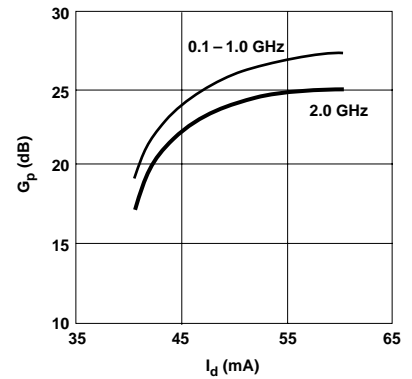

Figure 3. Power Gain vs. Current.

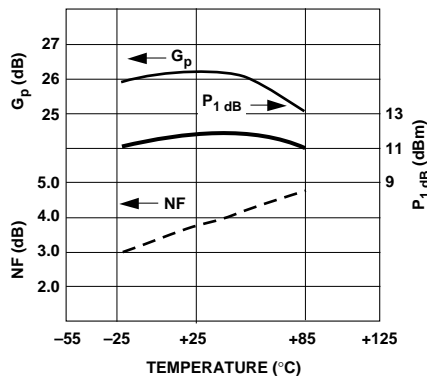

Figure 4. Output Power and 1 dB Gain Compression, NF and Power Gain vs. Case Temperature, $f = 1.5 \text{ GHz}$, $V_d = 6 \text{ V}$.

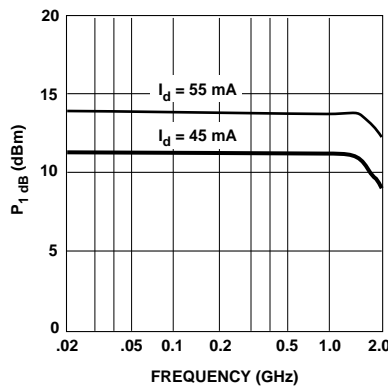

Figure 5. Output Power at 1 dB Gain Compression vs. Frequency.

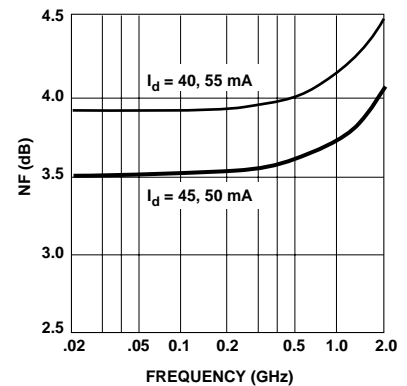
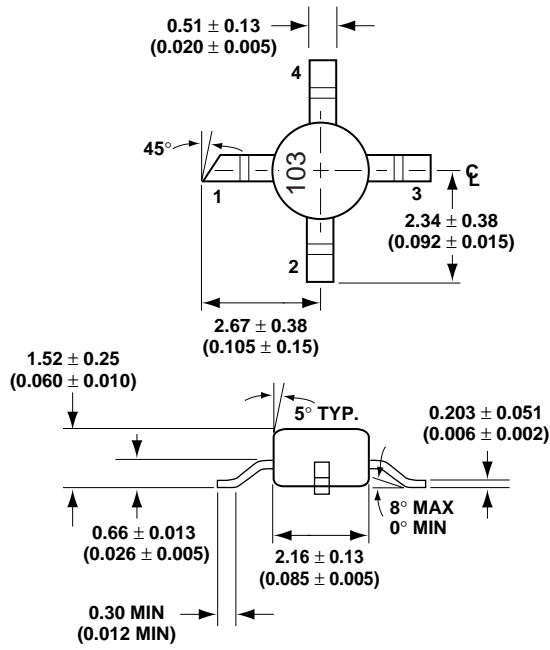

Figure 6. Noise Figure vs. Frequency.

86 Plastic Package Dimensions



DIMENSIONS ARE IN MILLIMETERS (INCHES)