

Features

- Complete variable-gain amplifier with output amplifier, requires no extra components
- Excellent linearity of 0.2%
- 70 MHz signal bandwidth
- Operates on $\pm 5V$ to $\pm 15V$ supplies
- All inputs are differential
- 400V/ μs slew rate
- >70dB attenuation @ 4 MHz

Applications

- Leveling of varying inputs
- Variable filters
- Fading
- Text insertion into video

Ordering Information

Part No.	Temp. Range	Package	Outline #
EL4451CN	-40°C to +85°C	14-Pin P-DIP	MDP0031
EL4451CS	-40°C to +85°C	14-Lead SO	MDP0027

General Description

The EL4451C is a complete variable gain circuit. It offers wide bandwidth and excellent linearity while including a powerful output voltage amplifier, drawing modest supply current.

The EL4451C operates on $\pm 5V$ to $\pm 15V$ supplies and has an analog input range of $\pm 2V$, making it ideal for video signal processing. AC characteristics do not change appreciably over the $\pm 5V$ to $\pm 15V$ supply range.

The circuit has an operational temperature range of $-40^\circ C$ to $+85^\circ C$ and is packaged in plastic 14-pin DIP and 14-lead SO.

The EL4451C is fabricated with Elantec's proprietary complementary bipolar process which provides excellent signal symmetry and is free from latch up.

Connection Diagram

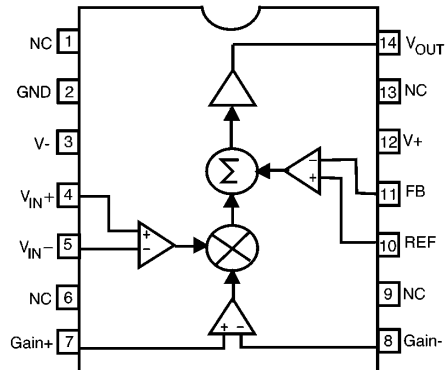

4451-1

Note: All information contained in this data sheet has been carefully checked and is believed to be accurate as of the date of publication; however, this data sheet cannot be a "controlled document". Current revisions, if any, to these specifications are maintained at the factory and are available upon your request. We recommend checking the revision level before finalization of your design documentation.

EL4451C

Wideband Variable-Gain Amplifier, Gain of 2

Absolute Maximum Ratings ($T_A = 25^\circ\text{C}$)

V+	Positive Supply Voltage	16.5V	I _{OUT}	Continuous Output Current	30mA
V _S	V+ to V- Supply Voltage	33V	P _D	Maximum Power Dissipation	See Curves
V _{IN}	Voltage at any Input or Feedback	V+ to V-	T _A	Operating Temperature Range	-40°C to +85°C
ΔV _{IN}	Difference between Pairs of Inputs or Feedback	6V	T _S	Storage Temperature Range	-60°C to +150°C
I _{IN}	Current into any Input, or Feedback Pin	4mA			

Important Note:

All parameters having Min/Max specifications are guaranteed. The Test Level column indicates the specific device testing actually performed during production and Quality inspection. Elantec performs most electrical tests using modern high-speed automatic test equipment, specifically the LTX77 Series system. Unless otherwise noted, all tests are pulsed tests, therefore $T_J = T_C = T_A$.

Test Level	Test Procedure
I	100% production tested and QA sample tested per QA test plan QCX0002.
II	100% production tested at $T_A = 25^\circ\text{C}$ and QA sample tested at $T_A = 25^\circ\text{C}$, T_{MAX} and T_{MIN} per QA test plan QCX0002.
III	QA sample tested per QA test plan QCX0002.
IV	Parameter is guaranteed (but not tested) by Design and Characterization Data.
V	Parameter is typical value at $T_A = 25^\circ\text{C}$ for information purposes only.

Open-Loop DC Electrical Characteristics Power Supplies at $\pm 5\text{V}$, $T_A = 25^\circ\text{C}$, $R_L = 500\Omega$.

Parameter	Description	Min	Typ	Max	Test Level	Units
V _{DIFF}	Signal input differential input voltage - Clipping 0.2% nonlinearity	1.8	2.0 1.3		I V	V V
V _{CM}	Common-mode range of V _{IN} ; V _{DIFF} = 0, V _s = $\pm 5\text{V}$ V _s = $\pm 15\text{V}$	± 2.0	± 2.8 ± 12.8		I V	V V
V _{OS}	Input offset voltage		7	25	I	mV
V _{OS, FB}	Output offset voltage		8	25	I	mV
V _{G, 100%}	Extrapolated voltage for 100% gain	1.9	2.1	2.2	I	V
V _{G, 0%}	Extrapolated voltage for 0% gain	-0.16	-0.06	0.06	I	V
V _{G, 1V}	Gain at V _{GAIN} = 1V	0.95	1.05	1.15	I	V/V
I _B	Input bias current (all inputs)	-20	-9	0	I	μA
I _{OS}	Input offset current between V _{IN} ⁺ and V _{IN} ⁻ , Gain ⁺ and Gain ⁻ , FB and Ref		0.2	4	I	μA
NL	Nonlinearity, V _{IN} between -1V and +1V, V _G = 1V		0.2	0.5	I	%
Ft	Signal feedthrough, V _G = -1V		-100	-70	I	dB
R _{IN, V_{IN}}	Input resistance, V _{IN}	100	230		I	KΩ
R _{IN, FB}	Input resistance, FB	200	460		V	KΩ
R _{IN, R_{GAIN}}	Input resistance, gain input	50	100		I	KΩ

EL4451C

Wideband Variable-Gain Amplifier, Gain of 2

Open-Loop DC Electrical Characteristics — Contd.

Power Supplies at $\pm 5\text{V}$, $T_A = 25^\circ\text{C}$, $R_L = 500\Omega$.

Parameter	Description	Min	Typ	Max	Test Level	Units
CMRR	Common-mode rejection ratio of V_{IN}	70	90		I	dB
PSRR	Power supply rejection ratio of $V_{OS, FB}$, $V_S = \pm 5\text{V}$ to $\pm 15\text{V}$	50	60		I	dB
V_O	Output voltage swing $V_S = \pm 5\text{V}$ ($V_{IN} = 0$, V_{REF} varied) $V_S = \pm 15\text{V}$	± 2.5 ± 12.5	± 2.8 ± 12.8		I	V
I_{SC}	Output short-circuit current	40	85		I	mA
I_S	Supply current, $V_S = \pm 15\text{V}$		15.5	18	I	mA

Closed-Loop AC Electrical Characteristics

Power supplies at $\pm 12\text{V}$, $T_A = 25^\circ\text{C}$, $R_L = 500\Omega$, $C_L = 15\text{pF}$, $V_G = 1\text{V}$

Parameter	Description	Min	Typ	Max	Test Level	Units
BW, -3dB	-3dB small-signal bandwidth, signal input		70		V	MHz
BW, $\pm 0.1\text{dB}$	0.1dB flatness bandwidth, signal input		10		V	MHz
Peaking	Frequency response peaking		0.6		V	dB
BW, gain	-3dB small-signal bandwidth, gain input		70		V	MHz
SR	Slew rate, V_{OUT} between -2V and $+2\text{V}$, $R_F = R_G = 500\Omega$		400		V	$\text{V}/\mu\text{s}$
V_N	Input referred noise voltage density		110		V	$\text{nV}/\sqrt{\text{Hz}}$
dG	Differential gain error, Voffset between -0.7V and $+0.7\text{V}$		0.9		V	%
$d\theta$	Differential phase error, Voffset between -0.7V and $+0.7\text{V}$		0.2		V	$^\circ$

Test Circuit

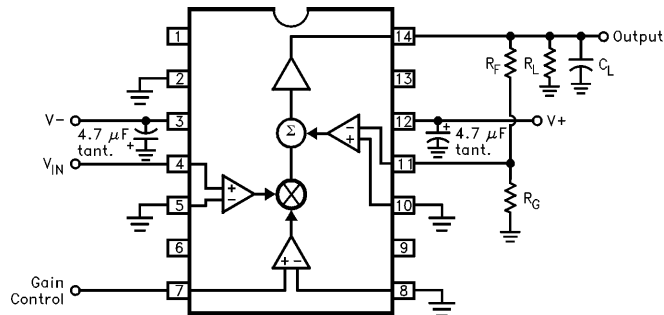

4451-3

Note: For typical performance curves, $R_F = 0$, $R_G = \infty$, $V_{GAIN} = 1\text{V}$, $R_L = 500\Omega$, and $C_L = 15\text{pF}$ unless otherwise noted.

EL4451C

Wideband Variable-Gain Amplifier, Gain of 2

Typical Performance Curves

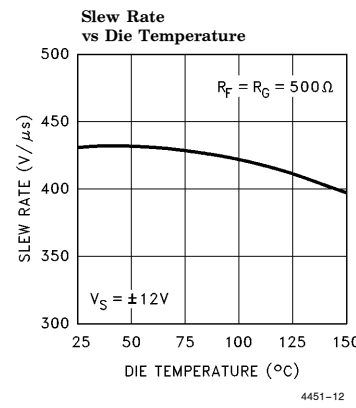
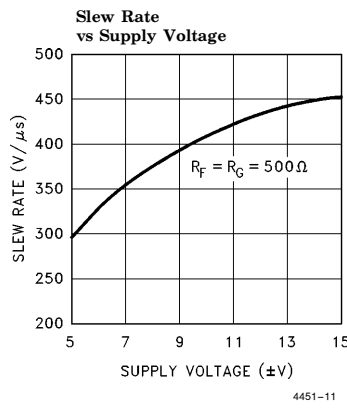
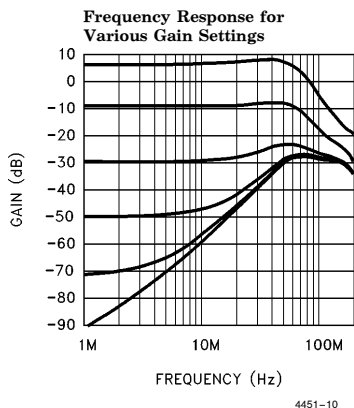
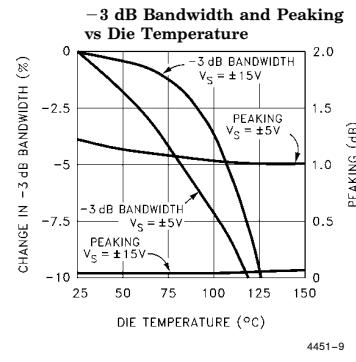
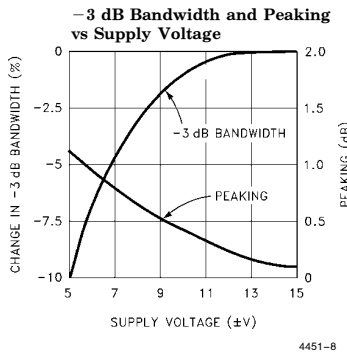
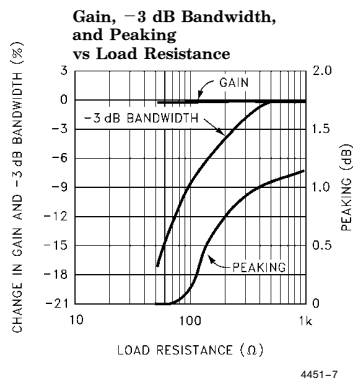
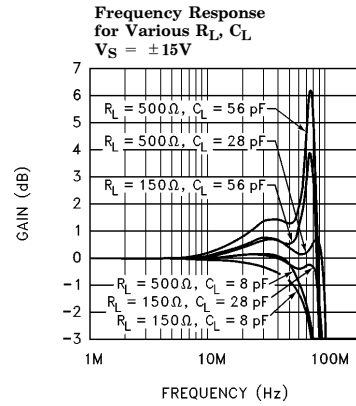
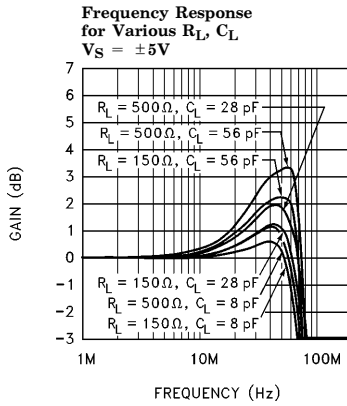
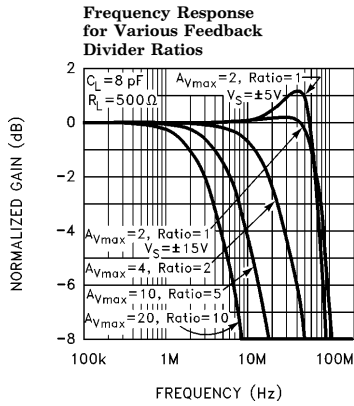

EL4451C

Wideband Variable-Gain Amplifier, Gain of 2

Typical Performance Curves — Contd.

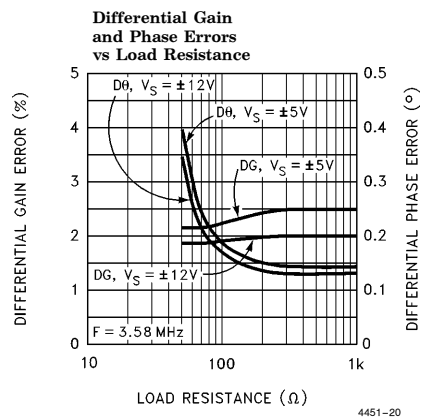
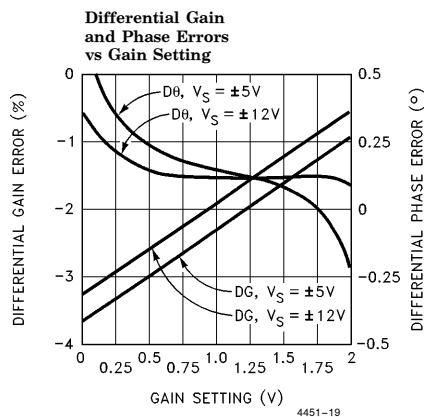
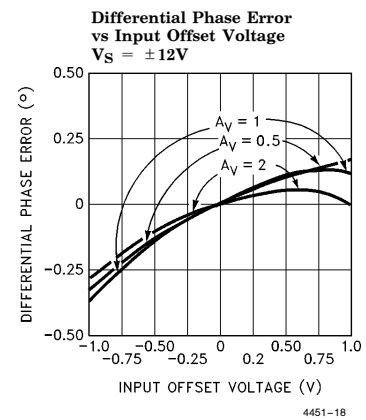
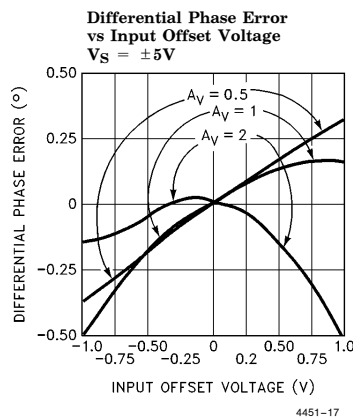
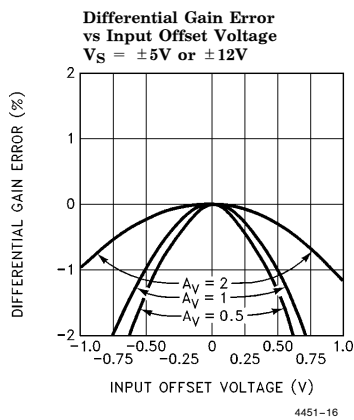
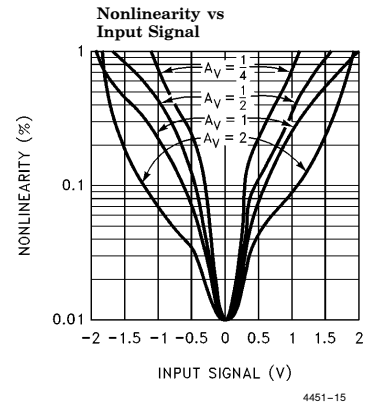
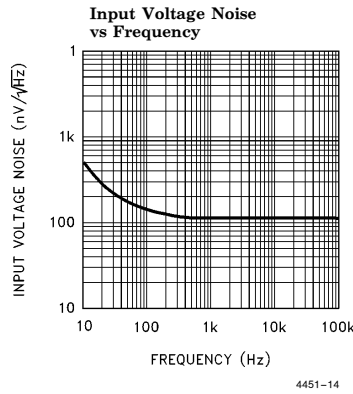
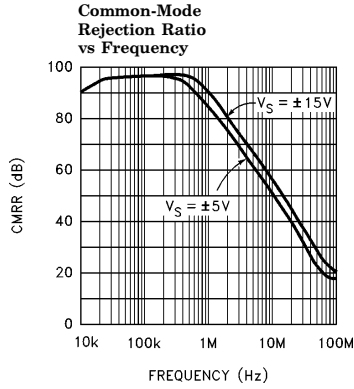

EL4451C

Wideband Variable-Gain Amplifier, Gain of 2

Typical Performance Curves — Contd.

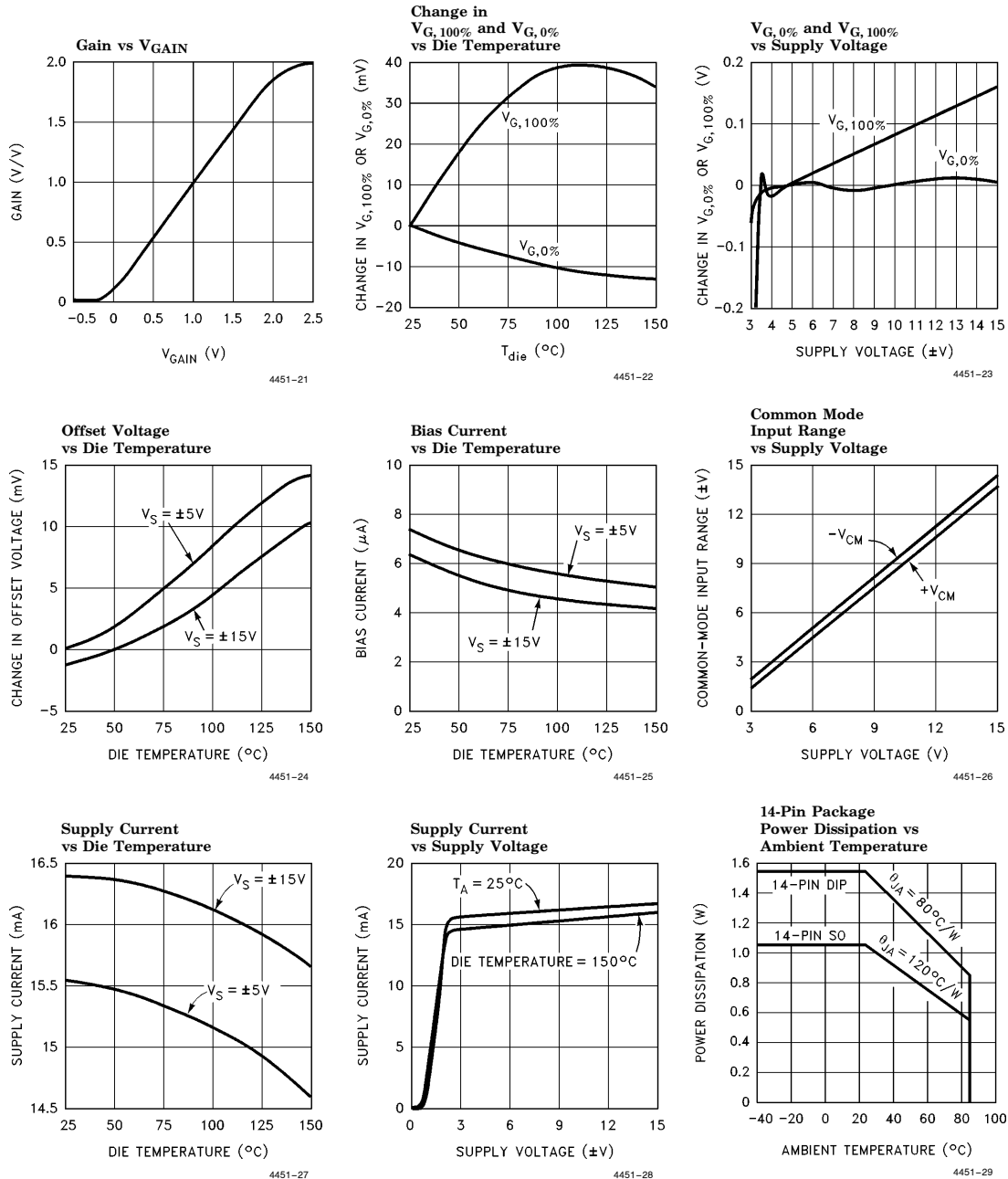

EL4451C

Wideband Variable-Gain Amplifier, Gain of 2

Applications Information

The EL4451 is a complete two-quadrant multiplier/gain control with 70 MHz bandwidth. It has three sets of inputs; a differential signal input V_{IN} , a differential gain-controlling input V_{GAIN} , and another differential input which is used to complete a feedback loop with the output. Here is a typical connection:

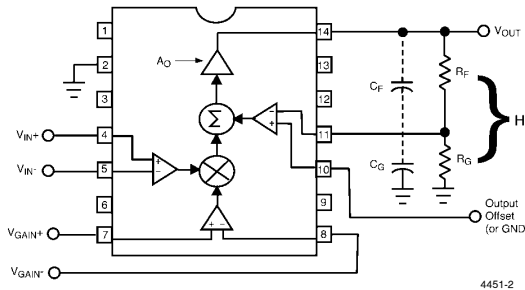

The gain of the feedback divider is

$$H = \frac{R_G}{R_G + R_F}$$

The transfer function of the part is

$$V_{OUT} = A_O \times ((V_{IN+}) - (V_{IN-})) \times ((V_{GAIN+}) - (V_{GAIN-})) + (V_{REF} - V_{FB})$$

V_{FB} is connected to V_{OUT} through a feedback network, so $V_{FB} = H \times V_{OUT}$. A_O is the open-loop gain of the amplifier, and is approximately 600. The large value of A_O drives

$$((V_{IN+}) - (V_{IN-})) \times ((V_{GAIN+}) - (V_{GAIN-})) + (V_{REF} - V_{FB}) \rightarrow 0$$

Rearranging and substituting for V_{FB}

$$V_{OUT} = (((V_{IN+}) - (V_{IN-})) \times ((V_{GAIN+}) - (V_{GAIN-})) + V_{REF})/H$$

$$\text{or}$$
$$V_{OUT} = (V_{IN} \times V_{GAIN} + V_{REF})/H$$

Thus the output is equal to the difference of the V_{IN} 's times the difference of V_{GAIN} 's and offset by V_{REF} , all gained up by the feedback divider ratio. The EL4451 is stable for a direct connection between V_{OUT} and FB, and the divider may be used for higher output gain, although with the traditional loss of bandwidth.

It is important to keep the feedback divider's impedance at the FB terminal low so that stray capacitance does not diminish the loop's phase margin. The pole caused by the parallel impedance of the feedback resistors and stray capacitance should be at least 150 MHz; typical strays of 3 pF thus require a feedback impedance of

360Ω or less. Alternatively, a small capacitor across R_F can be used to create more of a frequency-compensated divider. The value of the capacitor should scale with the parasitic capacitance at the FB input. It is also practical to place small capacitors across both the feedback and the gain resistors (whose values maintain the desired gain) to swamp out parasitics. For instance, two 10pF capacitors across equal divider resistors for a maximum gain of 4 will dominate parasitic effects and allow a higher divider resistance.

The REF pin can be used as the output's ground reference, for DC offsetting of the output, or it can be used to sum in another signal.

Gain-Control Characteristics

The quantity V_{GAIN} in the above equations is bounded as $0 \leq V_{GAIN} \leq 2$, even though the externally applied voltages exceed this range. Actually, the gain transfer function around 0 and 2V is "soft"; that is, the gain does not clip abruptly below the 0%- V_{GAIN} voltage nor above the 100%- V_{GAIN} level. An overdrive of 0.3V must be applied to V_{GAIN} to obtain truly 0% or 100%. Because the 0%- or 100%- V_{GAIN} levels cannot be precisely determined, they are extrapolated from two points measured inside the slope of the gain transfer curve. Generally, an applied V_{GAIN} range of -0.5V to +2.5V will assure the full numerical span of $0 \leq V_{GAIN} \leq 2$.

The gain control has a small-signal bandwidth equal to the V_{IN} channel bandwidth, and overload recovery resolves in about 20 nsec.

Input Connections

The input transistors can be driven from resistive and capacitive sources, but are capable of oscillation when presented with an inductive input. It takes about 80nH of series inductance to make the inputs actually oscillate, equivalent to four inches of unshielded wiring or 6" of unterminated input transmission line. The oscillation has a characteristic frequency of 500 MHz. Often placing one's finger (via a metal probe) or an oscilloscope probe on the input will kill the oscillation. Normal high-frequency construction obviates any such problems, where the input source is reasonably close to the input. If this is not possible, one can insert series resistors of around 51Ω to de-Q the inputs.

EL4451C

Wideband Variable-Gain Amplifier, Gain of 2

Applications Information — Contd.

Signal Amplitudes

Signal input common-mode voltage must be between $(V-) + 3V$ and $(V+) - 3V$ to ensure linearity. Additionally, the differential voltage on any input stage must be limited to $\pm 6V$ to prevent damage. The differential signal range is $\pm 2V$ in the EL4451. The input range is substantially constant with temperature.

The Ground Pin

The ground pin draws only $6\mu A$ maximum DC current, and may be biased anywhere between $(V-) + 2.5V$ and $(V+) - 3.5V$. The ground pin is connected to the IC's substrate and frequency compensation components. It serves as a shield within the IC and enhances input stage CMRR and feedthrough over frequency, and if connected to a potential other than ground, it must be bypassed.

Power Supplies

The EL4451 works with any supplies from $\pm 3V$ to $\pm 15V$. The supplies may be of different voltages as long as the requirements of the ground pin are observed (see the Ground Pin section). The supplies should be bypassed close to the device with short leads. $4.7\mu F$ tantalum capacitors are very good, and no smaller bypasses need be placed in parallel. Capacitors as small as $0.01\mu F$ can be used if small load currents flow.

Single-polarity supplies, such as $+12V$ with $+5V$ can be used, where the ground pin is connected to $+5V$ and $V-$ to ground. The inputs and outputs will have to have their levels shifted above ground to accommodate the lack of negative supply.

The power dissipation of the EL4451 increases with power supply voltage, and this must be compatible with the package chosen. This is a close estimate for the dissipation of a circuit:

$$P_D = 2 \times V_S \times I_{S, \max} + (V_S - V_O) \times V_O / R_{PAR}$$

where $I_{S, \max}$ is the maximum supply current

V_S is the \pm supply voltage (assumed equal)

V_O is the output voltage

R_{PAR} is the parallel of all resistors loading the output

For instance, the EL4451 draws a maximum of 18mA. With light loading, $R_{PAR} \rightarrow \infty$ and the dissipation with $\pm 5V$ supplies is 180 mW. The maximum supply voltage that the device can run on for a given P_D and other parameters is

$$V_{S, \max} = (P_D + V_O^2 / R_{PAR}) / (2I_S + V_O / R_{PAR})$$

The maximum dissipation a package can offer is

$$P_{D, \max} = (T_{J, \max} - T_{A, \max}) / \theta_{JA}$$

Where $T_{J, \max}$ is the maximum die temperature, $150^\circ C$ for reliability, less to retain optimum electrical performance

$T_{A, \max}$ is the ambient temperature, $70^\circ C$ for commercial and $85^\circ C$ for industrial range

θ_{JA} is the thermal resistance of the mounted package, obtained from data sheet dissipation curves

The more difficult case is the SO-14 package. With a maximum die temperature of $150^\circ C$ and a maximum ambient temperature of $85^\circ C$, the $65^\circ C$ temperature rise and package thermal resistance of $120^\circ C/W$ gives a dissipation of 542 mW at $85^\circ C$. This allows the full maximum operating supply voltage unloaded, but reduced if loaded.

Output Loading

The output stage of the EL4451 is very powerful. It typically can source 80mA and sink 120mA. Of course, this is too much current to sustain and the part will eventually be destroyed by excessive dissipation or by metal traces on the die opening. The metal traces are completely reliable while delivering the 30mA continuous output given in the Absolute Maximum Ratings table in this data sheet, or higher purely transient currents.

Gain changes only 0.2% from no load to 100Ω load. Heavy resistive loading will degrade frequency response and video distortion for loads $< 100\Omega$.

Capacitive loads will cause peaking in the frequency response. If capacitive loads must be driven, a small-valued series resistor can be used to isolate it. 12Ω to 51Ω should suffice. A 22Ω series resistor will limit peaking to 2.5 dB with even a 220pF load.

EL4451C

Wideband Variable-Gain Amplifier, Gain of 2

Applications Information — Contd.

Leveling Circuits

Often a variable-gain control is used to normalize an input signal to a standard amplitude from a modest range of possible input amplitude. A good example is in video systems, where an unterminated cable will yield a twice-sized standard video amplitude, and an erroneously twice-terminated cable gives a 2/3-sized input.

Here is a ± 6 dB range preamplifier:

Linearized Leveling Amplifier

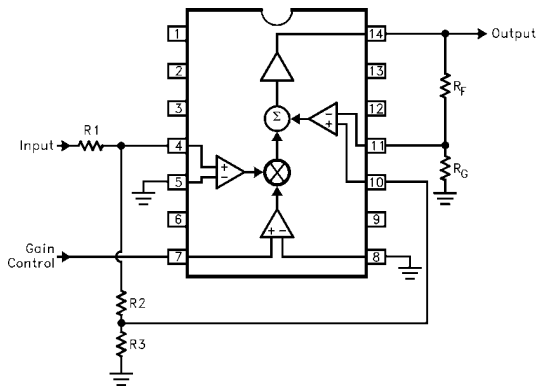

4451-30

In this arrangement, the EL4451 outputs a mixture of the signal routed through the multiplier and the REF terminal. The multiplier port produces the most distortion and needs to handle a fraction of an oversized video input, whereas the REF port is just like an op-amp input summing into the output. Thus, for oversized inputs the gain will be decreased and the majority of the signal is routed through the linear REF terminal. For undersized inputs, the gain is increased and the multiplier's contribution added to the output.

Here are some component values for two designs:

Attenuation Ratio	R _F	R _G	R ₁	R ₂	R ₃	-3 dB Bandwidth
1.5	200Ω	400Ω	300Ω	100Ω	200Ω	47 MHz
2	400Ω	400Ω	500Ω	100Ω	200Ω	28 MHz

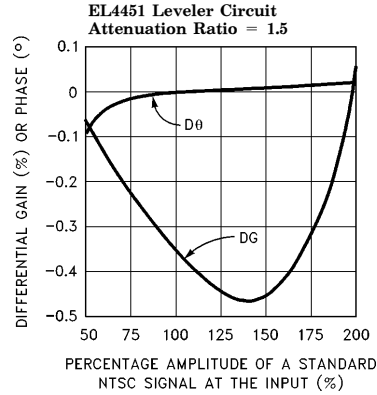

4451-31

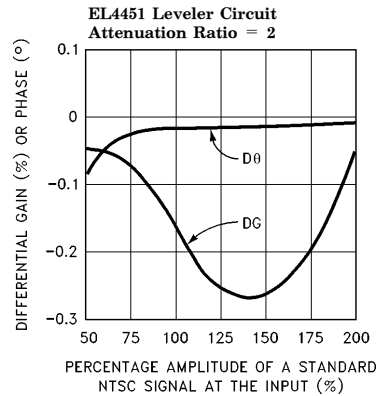

4451-32

With the higher attenuation ratio, the multiplier sees a smaller input amplitude and distorts less, however the higher output gain reduces circuit bandwidth. As seen in the next curves, the peak differential gain error is 0.47% for the attenuation ratio of 1.5, but only 0.27% with the gain of 2 constants. To maintain bandwidth, an external op amp can be used instead of the R_F - R_G divider to boost the EL4451's output by the attenuation ratio.

Sinewave Oscillators

Generating a stable, low distortion sinewave has long been a difficult task. Because a linear oscillator's output tends to grow or diminish continuously, either a clipping circuit or automatic gain control (AGC) is needed. Clipping circuits generate severe distortion which needs subsequent filtering, and AGC's can be complicated.

EL4451C

Wideband Variable-Gain Amplifier, Gain of 2

Applications Information — Contd.

Here is the EL4451 used as an oscillator with simple AGC:

Low-Distortion Sinewave Oscillator

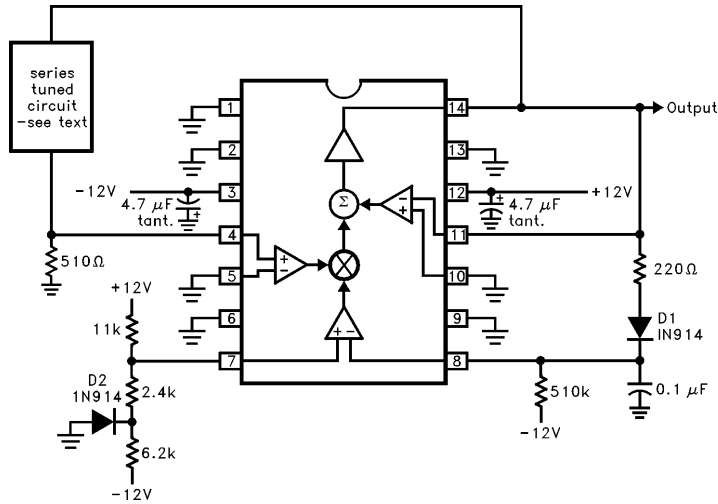

4451-33

The oscillation frequency is set by the resonance of a series-tuned circuit, which may be an L-C combination or a crystal. At resonance, the series impedance of the tuned circuit drops and its phase lag is 0° , so the EL4451 needs a gain just over unity to sustain oscillation. The V_{GAIN-} terminal is initially at $-0.7V$ and the V_{GAIN+} terminal at about $+2.1V$, setting the maximum gain in the EL4451. At such high gain, the loop oscillates and output amplitude grows until D_1 rectifies more positive voltage at V_{GAIN-} , ultimately reducing gain until a stable $0.5V_{rms}$ output is produced.

Using a 2 MHz crystal, output distortion was -53 dBc, or 0.22%. Sideband modulation was only 14 Hz wide at -90 dBc, limited by the filter of the spectrum analyzer used.

The circuit works up to 30 MHz. A parallel-tuned circuit can replace the 510Ω resistor and the 510Ω resistor moved in place of the series-tuned element to allow grounding of the tuned components.

Filters

The EL4451 can be connected to act as a voltage-variable integrator as shown:

EL4451 Connected As Variable Integrator

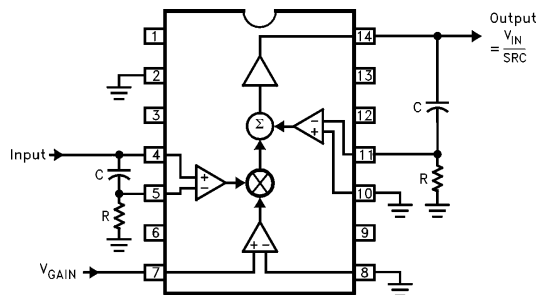

4451-34

The input RC cancels a zero produced by the output op-amp feedback connection at $\omega = 1/RC$. With the input RC connected $V_{OUT}/V_{IN} = 1/sRC$; without it $V_{OUT}/V_{IN} = (1 + sRC)/sRC$. This variable integrator may be used in networks such as the Bi-quad. In some applications the input RC may be omitted. If a negative gain is required, the V_{IN+} and V_{IN-} terminals can be exchanged.

EL4451C

Wideband Variable-Gain Amplifier, Gain of 2

Applications Information — Contd.

A voltage-controlled equalizer and cable driver can be constructed so:

Equalization and Line Driver Amplifier

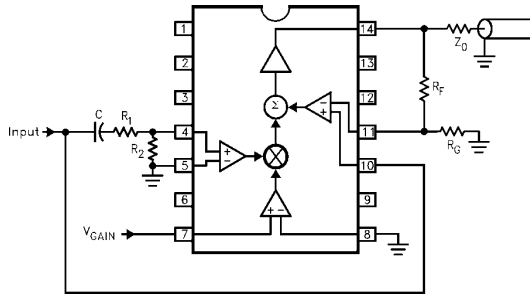

4451-35

The main signal path is via the REF pin. This ensures maximum signal linearity, while the multiplier input is used to allow a variable amount of frequency-shaped input from R_1 , R_2 , and C . For optimum linearity, the multiplier input is attenuated by R_1 and R_2 . This may not be necessary, depending on input signal amplitude, and R_1 might be set to 0. R_1 and R_2 should be set to provide sufficient peaking, depending on cable high-frequency losses, at maximum gain. R_F and R_G are chosen to provide the desired circuit gain, including backmatch resistor loss.

EL4451C

Wideband Variable-Gain Amplifier, Gain of 2

General Disclaimer

Specifications contained in this data sheet are in effect as of the publication date shown. Elantec, Inc. reserves the right to make changes in the circuitry or specifications contained herein at any time without notice. Elantec, Inc. assumes no responsibility for the use of any circuits described herein and makes no representations that they are free from patent infringement.



Elantec, Inc.
1996 Tarob Court
Milpitas, CA 95035
Telephone: (408) 945-1323
(800) 333-6314
Fax: (408) 945-9305
European Office: 44-71-482-4596

WARNING — Life Support Policy

Elantec, Inc. products are not authorized for and should not be used within Life Support Systems without the specific written consent of Elantec, Inc. Life Support systems are equipment intended to support or sustain life and whose failure to perform when properly used in accordance with instructions provided can be reasonably expected to result in significant personal injury or death. Users contemplating application of Elantec, Inc. products in Life Support Systems are requested to contact Elantec, Inc. factory headquarters to establish suitable terms & conditions for these applications. Elantec, Inc.'s warranty is limited to replacement of defective components and does not cover injury to persons or property or other consequential damages.