

## 4-BIT PARALLEL I/O CALENDAR CLOCK

The  $\mu$ PD4991A is a CMOS integrated circuit that has the ability to input/output 4-bit parallel time data and calendar data to/from a microcomputer and includes an alarm function.

Its reference oscillation frequency is 32.768 kHz. Hour, minute, second, year, month, day, and date data is stored internally.

The  $\mu$ PD4991A consumes 30 % less power than the  $\mu$ PD4991.

**FEATURES:**

- Time (hour, minute, and second) and calendar (leap year, year, month, day, and date) counters
- Leap year can be automatically identified or set
- 12- and 24-hour modes selectable
- 4-bit parallel input/output in BCD data format
- Alarm function (hour, minute, second, month, day, date)
- One of 0.1, 1.0, 10, 30, and 60-s interval timer outputs selectable
- One of 2048, 1024, 64, 16, 1 Hz, 1-pulse output, and H→L output selectable as alarm coincidence output
- Upward compatible with  $\mu$ PD4991
- Low power consumption: 2  $\mu$ A typ. ( $V_{DD} = 2.4$  V)

**ORDERING INFORMATION:**

Part Number	Package
$\mu$ PD4991ACX	18-pin plastic DIP (300 mil)
$\mu$ PD4991AGS	20-pin plastic SOP (300 mil)

PIN CONFIGURATION (Top View)

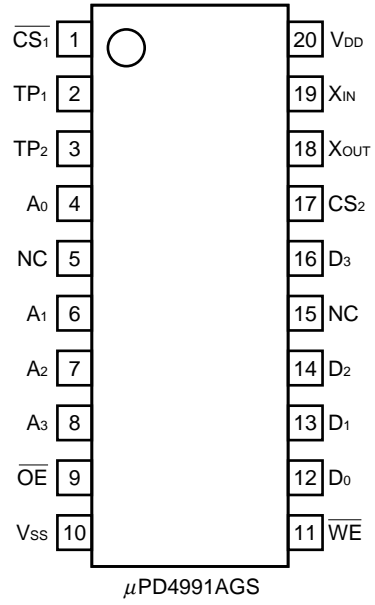
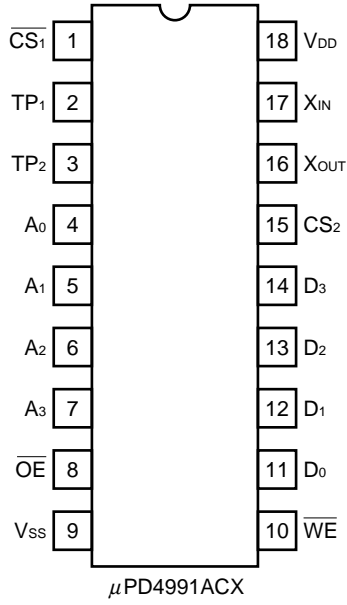

BLOCK DIAGRAM

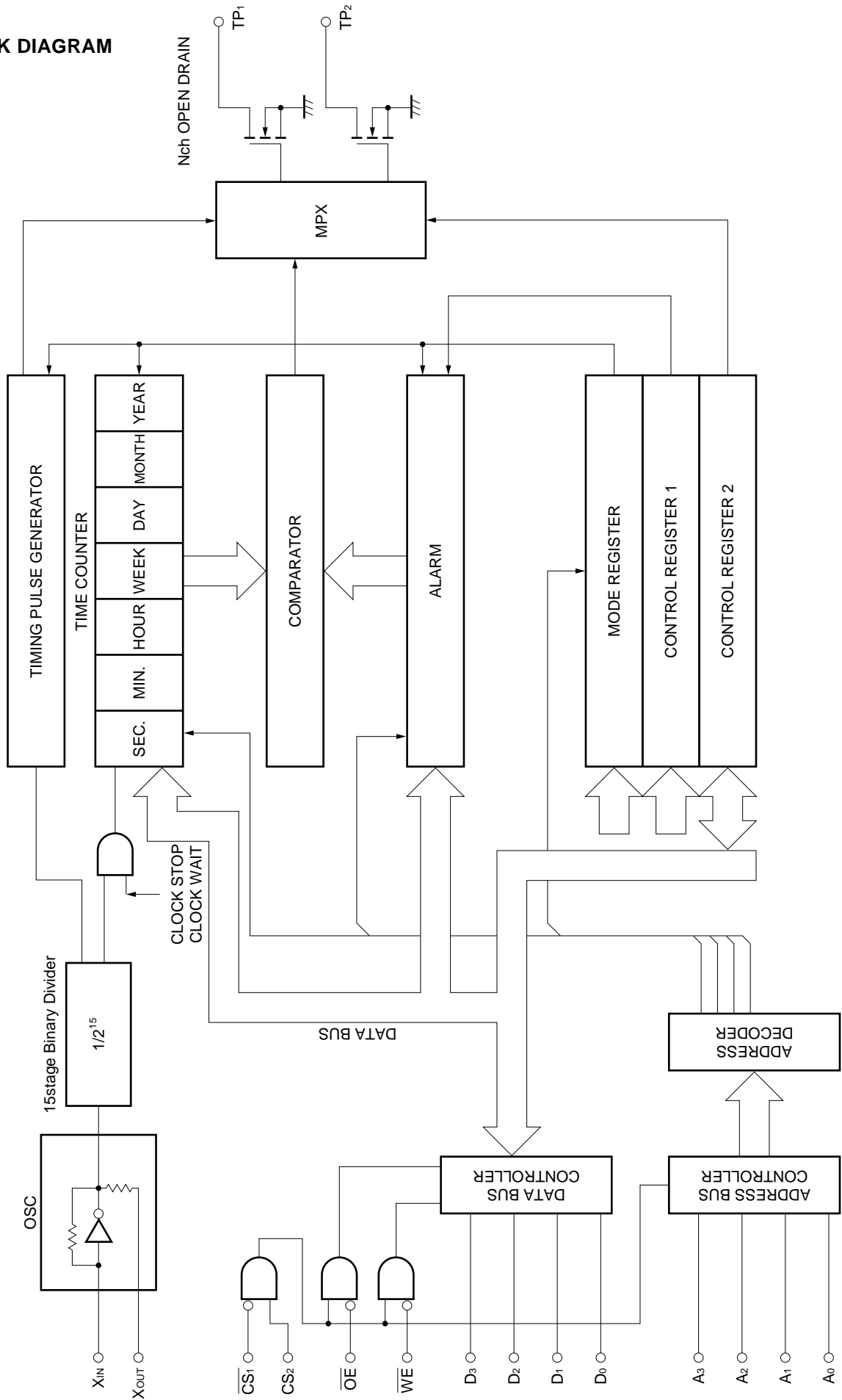

**PIN FUNCTION**

- $\overline{WE}$  ..... Write control pin (input).  
The contents of the data bus are written to an address specified by the address bus at the rising edge of  $\overline{WE}$ .
- $\overline{OE}$  ..... Read control pin (input).  
While  $\overline{OE}$  = "L" level, the contents specified by the address bus are read to the data bus.
- $A_3$  to  $A_0$  ..... Address bus pins (input).  
These pins specify an internal address of the  $\mu$ PD4991A.
- $D_3$  to  $D_0$  ..... Data bus pin (I/O).  
These pins constitute a bidirectional bus.
- $\overline{CS}_1$ ,  $CS_2$  ..... Chip select pins (input).  
When  $\overline{CS}_1$  = "L" and  $CS_2$  = "H", data can be transferred between the  $\mu$ PD4991A and the CPU.
- $TP_1$  ..... Timing pulse pin (output) (N-ch open-drain).  
Outputs an alarm coincidence signal.
- $TP_2$  ..... Timing pulse pin (output) (N-ch open-drain).  
Outputs an interval timer signal.
- $X_{IN}$  ..... Crystal oscillation signal pin (input).  
Inverter input for oscillation.
- $X_{OUT}$  ..... Crystal oscillation signal pin (output).  
Inverter output for oscillation.
- $V_{DD}$  ..... Positive power supply pin.
- $V_{SS}$  ..... GND pin.

**ABSOLUTE MAXIMUM RATINGS (V<sub>SS</sub> = 0 V)**

PARAMETER	SYMBOL	RATINGS	UNIT
Supply Voltage	V <sub>PP</sub>	-0.3 ~ 7.0	V
Input Voltage Range	V <sub>IN</sub>	-0.3 ~ V <sub>PP</sub> + 0.3	V
Output Pin Breakdown Voltage	V <sub>OUT</sub>	7.0	V
Low-Level Output Current (N-ch open-drain)	I <sub>OUT</sub>	30	mA
Operating Ambient Temperature	T <sub>opt</sub>	-40 ~ +85	°C
Storage Temperature	T <sub>stg</sub>	-65 ~ +125	°C

**ELECTRICAL CHARACTERISTICS**

(V<sub>SS</sub> = 0 V, f = 32.768 kHz, C<sub>G</sub> = C<sub>D</sub> = 20 pF, C<sub>i</sub> = 20 kΩ, T<sub>a</sub> = -40 to +85 °C)

PARAMETER	SYMBOL	MIN.	TYP.	MAX.	UNIT	CONDITIONS
Operating Voltage Range	V <sub>DD</sub>	2.0		5.5	V	
High-level Input Voltage	V <sub>IH</sub>	0.7 V <sub>DD</sub>		V <sub>DD</sub>	V	
Low-level Input Voltage	V <sub>IL</sub>	V <sub>SS</sub>		0.3 V <sub>DD</sub>	V	
Current Consumption *	I <sub>DD</sub>		5	14	μA	V <sub>DD</sub> = 3.6 V, V <sub>IN</sub> = V <sub>SS</sub> , T <sub>a</sub> = -40 ~ +70 °C
Current Consumption *	I <sub>DD</sub>			10	μA	V <sub>DD</sub> = 3.0 V, V <sub>IN</sub> = V <sub>SS</sub> , T <sub>a</sub> = -40 ~ +70 °C
Current Consumption *	I <sub>DD</sub>		2	6	μA	V <sub>DD</sub> = 2.4 V, V <sub>IN</sub> = V <sub>SS</sub> , T <sub>a</sub> = -40 ~ +70 °C
High-Level Input Leakage Current	I <sub>LIH</sub>			+1.0	μA	V <sub>DD</sub> = 5.5 V, V <sub>IN</sub> = V <sub>DD</sub>
Low-Level Input Leakage Current	I <sub>LIL</sub>			-1.0	μA	V <sub>DD</sub> = 5.5 V, V <sub>IN</sub> = V <sub>SS</sub>
High-Level Output Voltage	V <sub>OH</sub>	2.4			V	I <sub>OH</sub> = -1.0 mA
Low-Level Output Voltage	V <sub>OL1</sub>			0.4	V	I <sub>OL</sub> = 2.0 mA
Low-Level Output Voltage	V <sub>OL2</sub>			0.4	V	I <sub>OL</sub> = 1.0 mA (Nch Open Drain)
High-Level Leakage Current	I <sub>LOH</sub>			1.0	μA	TP <sub>out</sub> = V <sub>DD</sub> (Nch Open Drain)

\* If V<sub>IN</sub> pins are not V<sub>SS</sub>, Current Consumption increase in value.

**AC CHARACTERISTICS**

Write cycle (Unless otherwise specified, V<sub>DD</sub> = 5 V ± 10 %, T<sub>a</sub> = -40 to +85 °C)

PARAMETER	SYMBOL	MIN.	TYP.	MAX.	UNIT	CONDITIONS
Cycle Time	t <sub>wc</sub>	150			ns	
CS-WE Reset Time	t <sub>cw</sub>	120				
Address-WE Reset Time	t <sub>aw</sub>	120				
Address-WE Setup Time	t <sub>as</sub>	0				
Write Pulse Width	t <sub>wp</sub>	90				
Address Hold Time	t <sub>wr</sub>	20				
Input Data Setup Time	t <sub>dw</sub>	50				
Input Data Hold Time	t <sub>dh</sub>	0				
WE-Output Floating Time	t <sub>whz</sub>			50		

**Write Cycle (V<sub>DD</sub> = 2.7 to 3.6 V, T<sub>a</sub> = -40 to +85 °C)**

PARAMETER	SYMBOL	MIN.	TYP.	MAX.	UNIT	CONDITIONS
Cycle Time	t <sub>WC</sub>	210			ns	
CS-WE Reset Time	t <sub>cw</sub>	170				
Address-WE Reset Time	t <sub>AW</sub>	170				
Address-WE Setup Time	t <sub>AS</sub>	0				
Write Pulse Width	t <sub>WP</sub>	30				
Address Hold Time	t <sub>WR</sub>	20				
Input Data Setup Time	t <sub>DW</sub>	100				
Input Data Hold Time	t <sub>DH</sub>		0			
WE-Output Floating Time	t <sub>WHZ</sub>			70		

Write cycle timing 1

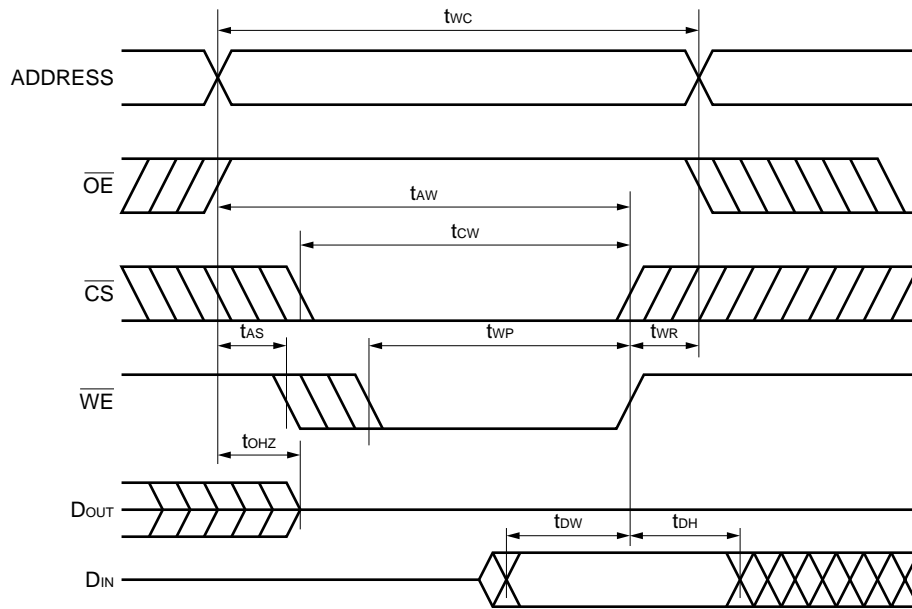

Write cycle timing 2 ( $\overline{OE} = V_{IL}$ )

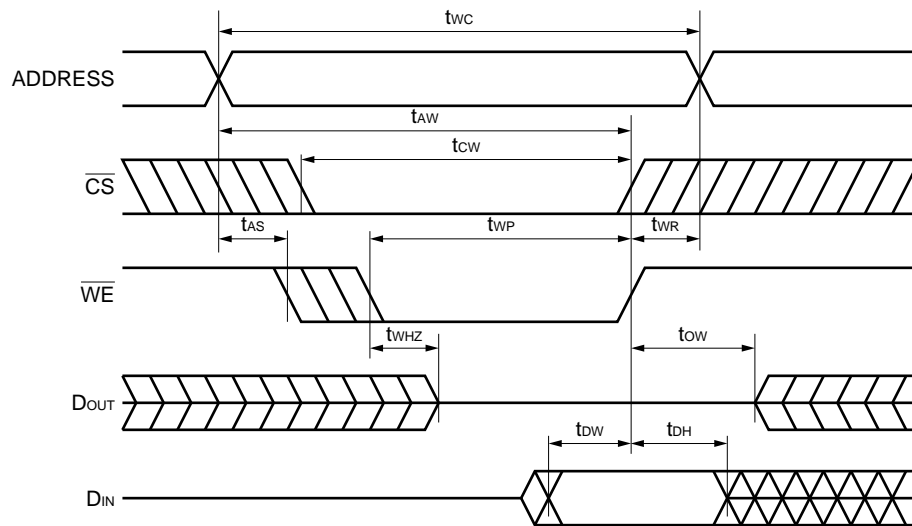

**READ CYCLE (Unless otherwise specified, V<sub>DD</sub> = 5 V ± 10 %, T<sub>a</sub> = -40 to +85 °C)**

PARAMETER	SYMBOL	MIN.	TYP.	MAX.	UNIT	CONDITIONS
Cycle Time	t <sub>RC</sub>	150			ns	
Address Access Time	t <sub>AA</sub>			150		
$\overline{\text{CS}}$ -Access Time	t <sub>ACS</sub>			150		
$\overline{\text{OE}}$ -Output Delay Time	t <sub>OE</sub>			75		
$\overline{\text{OE}}$ -Output Delay Time	t <sub>OLZ</sub>	5				
$\overline{\text{OE}}$ -Output Delay Time	t <sub>OHZ</sub>			50		
Output Hold Time	t <sub>OH</sub>	15				
$\overline{\text{CS}}$ -Output Set Time	t <sub>CLZ</sub>	0				
$\overline{\text{CS}}$ -Output Floating Time	t <sub>CHZ</sub>	5				

**Read Cycle (V<sub>DD</sub> = 2.7 to 3.6 V, T<sub>a</sub> = -40 to +85 °C)**

PARAMETER	SYMBOL	MIN.	TYP.	MAX.	UNIT	CONDITIONS
Cycle Time	t <sub>RC</sub>	210			ns	
Address Access Time	t <sub>AA</sub>			210		
$\overline{\text{CS}}$ -Access Time	t <sub>ACS</sub>			210		
$\overline{\text{OE}}$ -Output Delay Time	t <sub>OE</sub>			110		
$\overline{\text{OE}}$ -Output Delay Time	t <sub>OLZ</sub>	10				
$\overline{\text{OE}}$ -Output Delay Time	t <sub>OHZ</sub>			70		
Output Hold Time	t <sub>OH</sub>	20				
$\overline{\text{CS}}$ -Output Setup Time	t <sub>CLZ</sub>	15				
$\overline{\text{CS}}$ -Output Floating Time	t <sub>CHZ</sub>	10				



Read cycle timing 1

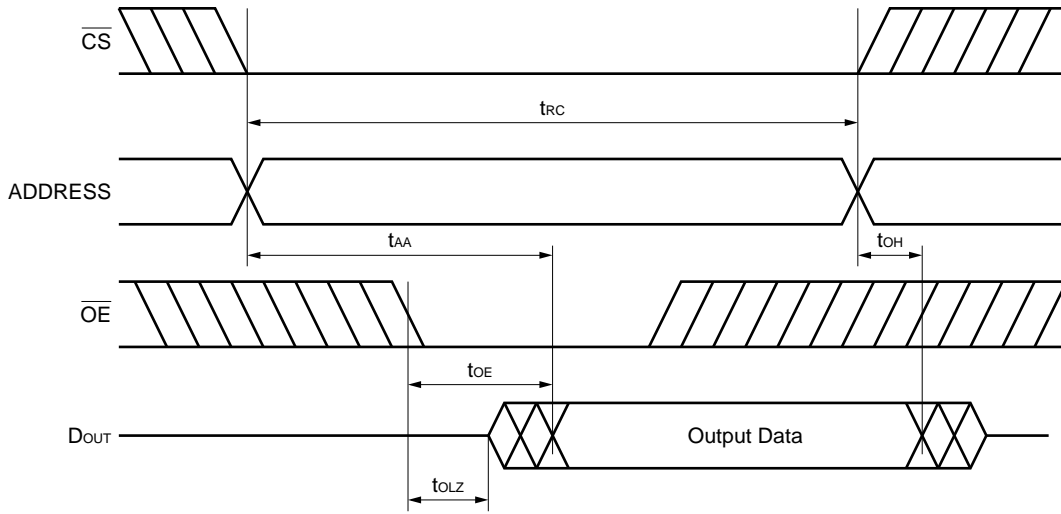

Read cycle timing 2

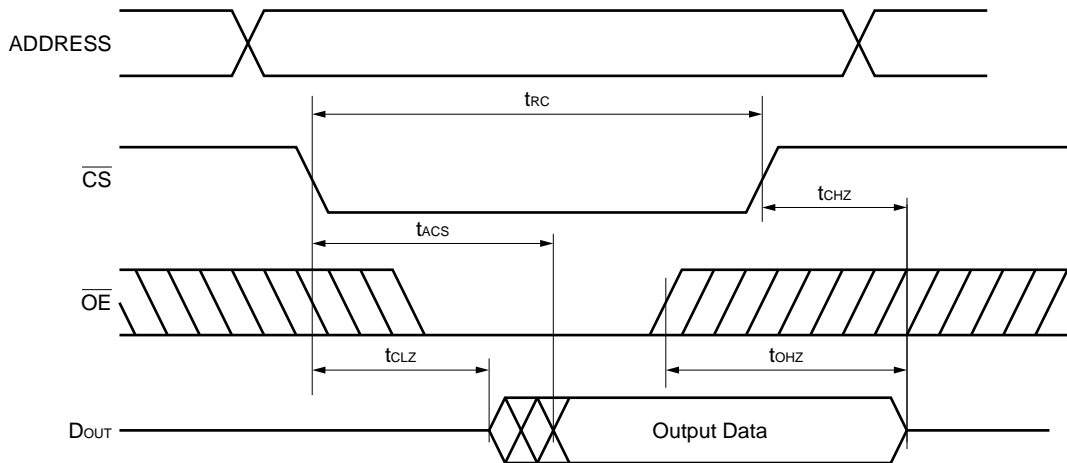

## FUNCTION SPECIFICATIONS

- Reference frequency (X'tal OSC) ..... 32.768 kHz
- Data format ..... BCD format
- Data function
  - Year, month, day, date, hour, minute, and second counters
  - Leap year and months are automatically identified.
  - Leap year is identified every 4 years and can be set to any year.
  - Year is set in 2 digits.
  - Hour can be displayed in 12- or 24-hour mode.
- Data input/output (D<sub>3</sub>, D<sub>2</sub>, D<sub>1</sub>, D<sub>0</sub>)
  - 4-bit parallel input/output format
  - Data is written by  $\overline{WE}$  signal and read by  $\overline{OE}$  signal.
- Function mode selection
  - With ADDRESS = "FH" (A<sub>3</sub>, A<sub>2</sub>, A<sub>1</sub>, A<sub>0</sub> = 1, 1, 1, 1), a mode is selected by DATA (D<sub>3</sub>, D<sub>2</sub>, D<sub>1</sub>, D<sub>0</sub>) input, and set by input of  $\overline{WE}$  signal.
  - A function is selected by ADDRESS input.
- Timing pulse outputs (TP<sub>1</sub>, TP<sub>2</sub>)
  - TP<sub>1</sub> ... Alarm coincidence signal.
    - One of the following is selectable:
      - 2048 Hz
      - 1024 Hz
      - 64 Hz
      - 16 Hz
      - 1 Hz
      - 1 pulse output (H → L)
  - TP<sub>2</sub> ... Interval timer signal output.
    - One of the following is selectable:
      - 60 s
      - 30 s
      - 10 s
      - 1 s
      - 0.1 s
- Chip select ( $\overline{CS_1}$ , CS<sub>2</sub>)
  - When  $\overline{CS_1}$  = "H" or CS<sub>2</sub> = "L," all inputs except X<sub>IN</sub> are disabled (non-select).
  - When  $\overline{CS_1}$  = "L" and CS<sub>2</sub> = "H," all inputs are selected.

## FUNCTION OUTLINE

- The μPD4991A has the following three modes:
  - ① BASIC TIME MODE  
In this mode, data can be written and read between the timer counter and the CPU. Moreover, control registers 1 and 2 can be specified by a command\*.
  - ② ALARM SET & TP<sub>1</sub> CONTROL MODE  
In this mode, data is set to the alarm register, the function of TP<sub>1</sub> is set, and control registers 1 and 2 are specified by a command\*.
  - ③ ALARM SET & TP<sub>2</sub> CONTROL MODE  
In this mode, data is set to the alarm register, the function of TP<sub>2</sub> is set, the 12- or 24-hour mode is selected, leap year identification function is set, and control registers 1 and 2 are specified by a command\*.

\* Control registers 1 and 2 are commonly used in all the modes.

To select a mode, write mode data to ADDRESS = "FH." Once a mode has been set, it is retained until a new mode is set.

Table 1 shows the correspondence between modes and mode data.

**Table 1 Correspondence between Mode Data and Modes**

ADDRESS = (1, 1, 1, 1)

DATA		FUNCTION
MSB	LSB	
0	* 0 0	BASIC TIME MODE
0	* 0 1	ALARM SET & TP <sub>1</sub> CONTROL MODE
0	* 1 0	ALARM SET & TP <sub>2</sub> CONTROL MODE
0	* 1 1	BASIC TIME MODE
1	* * *	Inhibited

\* Irrelevant. This bit is ignored.

**Note:** The difference between mode (0, \*, 0, 0) and mode (0, \*, 1, 1) is that stages 10 to 15 of the 15-stage divider circuit are reset in the former mode when the division stage reset command ( $\pm 30$  ADJ. RESET) is executed, and all the stages of the divider circuit are reset in the latter mode. Other commands are commonly used in both modes.

**MODE DESCRIPTION**

**1. BASIC TIME MODE (MODE = 0 \* 0 0 B)**

- Thirteen types of counters are provided: 10-year, 1-year, 10-month, 1-month, 10-day, 1-day, date, 10-hour, 1-hour, 10-minute, 1-minute, 10-second, and 1-second.
- Date codes are 00H through 06H (0000 through 0110B).  
(Correspondence between dates and date codes can be freely specified by the user.)
- If leap year identification function is not used, the last day of February is always the 28th.

The addresses corresponding to the respective digits are shown in Table 2 Address Correspondence 1.

Specifications of control registers 1 and 2 are commonly applied to each mode. Tables 3 and 4 show correspondences of data 1 and 2. Refer to these data correspondence tables when setting other modes.

**Table 2 Address Correspondence 1**

BASIC TIME MODE (MODE = 0, \*, 0, 0)

DATA		FUNCTION	
MSB	LSB		
0	0 0 0 0	1-second digit	R/W
0	0 0 0 1	10-second digit	R/W
0	0 1 0 0	1-minute digit	R/W
0	0 1 0 1	10-minute digit	R/W
0	1 0 0 0	1-hour digit	R/W
0	1 0 0 1	10-hour digit	R/W
0	1 1 0 0	Date digit	R/W
0	1 1 0 1	1-day digit	R/W
1	0 0 0 0	10-day digit	R/W
1	0 0 0 1	1-month digit	R/W
1	0 0 1 0	10-month digit	R/W
1	0 0 1 1	1-year digit	R/W
1	1 0 0 0	10-year digit	R/W
1	1 0 0 1	CONTROL REGISTER 1	W/O
1	1 0 1 0	CONTROL REGISTER 2	R/W
1	1 0 1 1	MODE REGISTER	W/O

R/W : READ AND WRITE

W/O : WRITE ONLY

**Note** The second most-significant bit of the data for the 10-hour digit serves as an AM/PM flag in the 12-hour mode (AM = 0/PM = 1).

**Table 3 Data Correspondence Table 1**

CONTROL REGISTER1 (TIME COUNTER CONTROL)

ADDRESS = (1, 1, 0, 1)

		D3	D2	D1	D0
W/O	0	NOP	RUN	NOP	NOP
	1	CLOCK WAIT <sup>*4</sup>	CLOCK STOP <sup>*3</sup>	ADJUST (+/-)30 s <sup>*1</sup>	RESET <sup>*2</sup>

**\*1. ADJUST (+/-)30 s**

Second digit 00 to 29 → 00 (second)

30 to 59 → 00 (second) + 1 (minute)

The BUSY flag remains set until a carry occurs.

In MODE (0, \*, 0, 0), stages 10 to 15 of the 15-stage divider are reset.

In MODE (0, \*, 1, 1), all the stages of the 15-stage divider are reset.

**\*2. RESET**

In MODE (0, \*, 0, 0), stages 10 to 15 of the 15-stage divider are reset.

In MODE (0, \*, 1, 1), all the stages of the 15-stage divider are reset.

**\*3. CLOCK STOP**

This command is used to write time.

To set time, execute the CLOCK RESET command and then the CLOCK STOP command. Then write the time data. If the data is written without the clock stopped, the correct value may not be set.

**\*4. CLOCK WAIT**

This command is used to read time.

When 1 is written to this bit, the clock is stopped. If the CLOCK RUN command is executed within 0.5 second, no delay in respect to the actual time occurs.

**Table 4 Data Correspondence Table 2**

CONTROL REGISTER2 (TP<sub>1</sub>/TP<sub>2</sub> CONTROL)

ADDRESS = (1, 1, 1, 0)

		D3	D2	D1	D0
W/O	0 (TP <sub>1</sub> )		ALARM setting	Alarm coincidence forced output flag	Output status
		0: ENABLE	0: RESET	0: ENABLE	
		1: DISABLE	1: SET	1: DISABLE	
	1 (TP <sub>2</sub> )		INTERVAL CLOCK	INTERVAL COUNTER	Output status
		0: RUN	0: NOP	0: ENABLE	
		1: CLK STOP	1: RESET	1: DISABLE	
R/O	*		BUSY flag	Alarm coincidence flag	Interval flag
		0: OFF	0: OFF	0: OFF	
		1: ON	1: ON	1: ON	

\*: Don't Care

R/O : READ ONLY

W/O : WRITE ONLY

**2. ALARM SET & TP<sub>1</sub> CONTROL MODE (MODE = 0 \* 0 1)  
ALARM SET & TP<sub>2</sub> CONTROL MODE (MODE = 0 \* 1 0)**

**(1) Setting time to alarm register**

The alarm register consists of a total of 44 bits with 4 bits each of 10-month digit, 1-month digit, 10-day digit, 1-day digit, date digit, 10-hour digit, 1-hour digit, 10-minute digit, 1-minute digit, 10-second digit, and 1-second digit.

- Manipulating alarm register

When “FH” is set to a certain digit of the alarm register, the digit is regarded as indicating an alarm coincidence, which occurs when the value of the alarm register coincides with the contents of the time counter, regardless of the data of the time counter.

If “FH” is set to all the digits, alarm coincidence occurs regardless of the data of the time counter. The addresses corresponding to the respective digits are shown in Table 5 Address Correspondence Table 2.

Tables 6 and 7 Data Correspondence Tables 3 and 4 show the function control of TP<sub>1</sub>/TP<sub>2</sub>.

Example: An alarm coincidence occurs for 1 second at 54 minutes 32 seconds of every hour.

Digit	10-month	1-month	10-day	1-day	Date	10-hour	1-hour	10-minute	1-minute	10-second	1-second
Code	F <sub>H</sub>	F <sub>H</sub>	F <sub>H</sub>	F <sub>H</sub>	F <sub>H</sub>	F <sub>H</sub>	F <sub>H</sub>	5 <sub>H</sub>	4 <sub>H</sub>	3 <sub>H</sub>	2 <sub>H</sub>

Example: An alarm coincidence occurs at 10 to 19 minutes of every hour.

Digit	10-month	1-month	10-day	1-day	Date	10-hour	1-hour	10-minute	1-minute	10-second	1-second
Code	F <sub>H</sub>	F <sub>H</sub>	F <sub>H</sub>	F <sub>H</sub>	F <sub>H</sub>	F <sub>H</sub>	F <sub>H</sub>	1 <sub>H</sub>	F <sub>H</sub>	F <sub>H</sub>	F <sub>H</sub>

Table 5 Address Correspondence Table 2

ALARM SET & TP<sub>1</sub> CONTROL MODE (MODE = 0, \*, 0, 1)ALARM SET & TP<sub>2</sub> CONTROL MODE (MODE = 0, \*, 1, 0)

ADDRESS		FUNCTION			
MSB	LSB				
0	0	0	0	1-second digit	R/W
0	0	0	1	10-second digit	R/W
0	0	1	0	1-minute digit	R/W
0	0	1	1	10-minute digit	R/W
0	1	0	0	1-hour digit	R/W
0	1	0	1	10-hour digit	R/W
0	1	1	0	Date digit	R/W
0	1	1	1	1-day digit	R/W
1	0	0	0	10-day digit	R/W
1	0	0	1	1-month digit	R/W
1	0	1	0	10-month digit	R/W
1	0	1	1	TP <sub>1</sub> /TP <sub>2</sub> FUNCTION CONTROL <sup>*1</sup>	W/O
1	1	0	0	Leap year/12-24 HOUR SELECT <sup>*2</sup>	R/W
1	1	0	1	CONTROL REGISTER1	W/O
1	1	1	0	CONTROL REGISTER2	R/W
1	1	1	1	MODE REGISTER	W/O

\*: Don't Care. This bit is ignored.

R/W : READ AND WRITE

W/O : WRITE ONLY

\*1. TP<sub>1</sub> FUNCTION CONTROL is performed in MODE (0, \*, 0, 1).  
 TP<sub>2</sub> FUNCTION CONTROL is performed in MODE (0, \*, 1, 0).

\*2. The leap year counter is in MODE (0, \*, 0, 1).  
 The 12/24 HOUR SELECT is in MODE (0, \*, 1, 0).



**Table 6 Data Correspondence Table 3**

TP<sub>1</sub> FUNCTION CONTROL

(MODE = 0, \*, 0, 1 ADDRESS = 1, 0, 1, 1)

DATA		FUNCTION	
MSB	LSB		
*	0 0 0	2048 Hz	W/O
*	0 0 1	1024 Hz	W/O
*	0 1 0	64 Hz	W/O
*	0 1 1	16 Hz	W/O
*	1 0 0	1 Hz	W/O
*	1 0 1	1-pulse output	W/O
*	1 1 0	"H" → "L"	W/O
*	1 1 1	BUSY	W/O
0	* * *	Alarm coincidence flag reset automatically	W/O
1	* * *	Alarm coincidence flag not reset automatically	W/O

W/O: WRITE ONLY

\*: Don't Care

**Table 7 Data Correspondence Table 4**

TP<sub>2</sub> FUNCTION CONTROL

(MODE = 0, \*, 1, 0 ADDRESS = 1, 0, 1, 1)

DATA		FUNCTION	
MSB	LSB		
*	0 0 0	0.1-s interval	W/O
*	0 0 1	1-s interval	W/O
*	0 1 0	10-s interval	W/O
*	0 1 1	30-s interval	W/O
*	1 0 0	60-s interval	W/O
0	1 1 1	BUSY	W/O
0	* * *	REPEAT	W/O
1	* * *	1 SHOT	W/O

W/O: WRITE ONLY

\*: Don't Care

**(2) Selecting 12-/24-hour mode**

In the 12-hour mode, the second significant bit of the data for the 10-hour digit are used as an AM/PM flag.

AM = 00\*\*

PM = 01\*\*

Select the 12- or 24-hour mode before setting the time. Note that, if the mode is selected after the time has been set, the data of the time counter is lost.

Table 8 Data Correspondence Table 5 shows how the 12- or 24-hour mode is selected.

**Table 8 Data Correspondence Table 5**

Leap year, 12-/24-hour mode selection

(MODE = 0, \*, 1, 0 ADDRESS = 1, 1, 0, 0)

	D3	D2	D1	D0
R/W	1: 24-hour mode 0: 12-hour mode	Leap Year 0: Valid 1: Invalid	*	*

\*: Don't Care

Example: In 12-hour mode

	10-hour digit	1-hour digit	Hexadecimal
AM 8 →	0000	1000	08H
PM 8 →	0100	1000	48H
AM12 →	0001	0010	12H
PM12 →	0101	0010	52H

**Notes on the use of the 12-hour mode**

When writing AM12, write the lower digit and then the higher digit (i.e., write “2” to the 1-hour digit, and then write “1” to the 10-hour digit); otherwise, PM12 may be set.

**(3) Setting leap year counter**

When a digit of year is written, the μPD4991A automatically sets the leap year counter.

Years are based on the Christian Era, and a leap year occurs every 4 years.

The user can directly write data to the leap year counter.

However, to do so, write the year counter first. If the leap year counter is written and then the year counter is written, the leap year counter is automatically reset.

The leap year is identified when the value of the leap year counter is \*\*00B.

The leap year counter can be set independently of the year counter.

The leap year counter is incremented in synchronization with the 1-year digit counter.

Table 9 Data Correspondence Table 6 shows how the leap year is identified.

**Table 9 Data Correspondence Table 6**

Leap year counter

(MODE = 0, \*, 0, 1, ADDRESS = 1, 1, 0, 0)

	D3	D2	D1	D0
R/W	*	*	Leap year counter (leap year = 0, 0)	

\*: Don't Care

Example

	10-year digit	1-year digit	Leap year counter	
	0 0 1 0	0 1 0 1	****	
Write 3 to 10-year digit	0 0 1 1	0 1 0 1	** 1 1	
Write 6 to 1-year digit	0 0 1 1	0 1 1 0	** 0 0	Incremented (Year 36 is a leap year → leap year counter = 00H)
Write 4 to 10-year digit	0 1 0 0	0 1 1 0	** 1 0	
Write **00B to the leap year counter	0 1 0 0	0 1 1 0	** 0 0	(Year 46 is not a leap year → leap year counter = 00H)

**3. TIMING PULSE**

○ TP1

The signal output from the TP1 pin is the alarm coincidence signal. The output waveform is selected from 2048 Hz, 1024 Hz, 64 Hz, 16 Hz, 1 Hz, 1-pulse output, and "H" → "L", depending on the contents set to the TP1 CONTROL REGISTER.

- 1-pulse output

One pulse is output when the value of the alarm register coincides with the contents of the time counter.

**Fig. 1 1-Pulse Output Waveform**

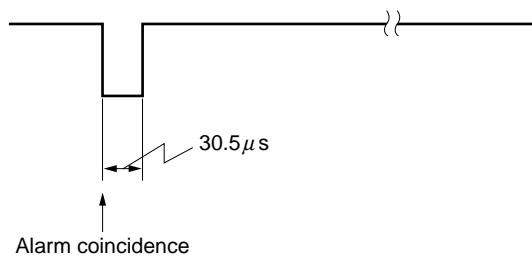

- “H” → “L” output  
The output signal of TP<sub>1</sub> goes from “H” to “L” when the value of the alarm register coincides with the contents of the time counter.

**Fig. 2 “H” → “L” Output Waveform**

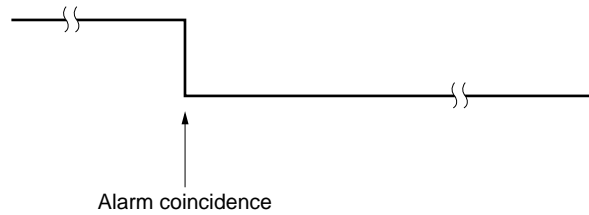

- Alarm coincidence flag, auto RESET  
When the value of the alarm register coincides with the contents of the time counter, a signal is output to the TP<sub>1</sub> pin.  
This signal remains output until the value of the alarm register does not coincide with the time counter contents.

**Fig. 3 TP<sub>1</sub> Output Waveform (with AUTO RESET)**

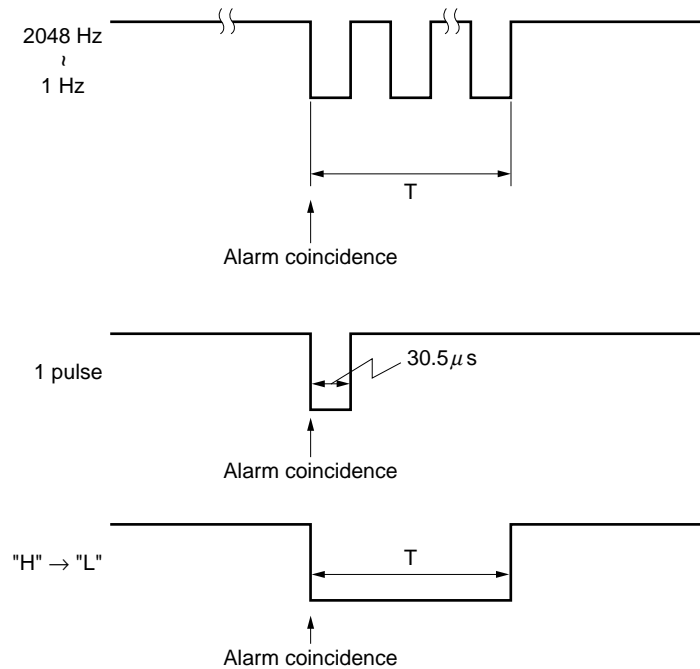
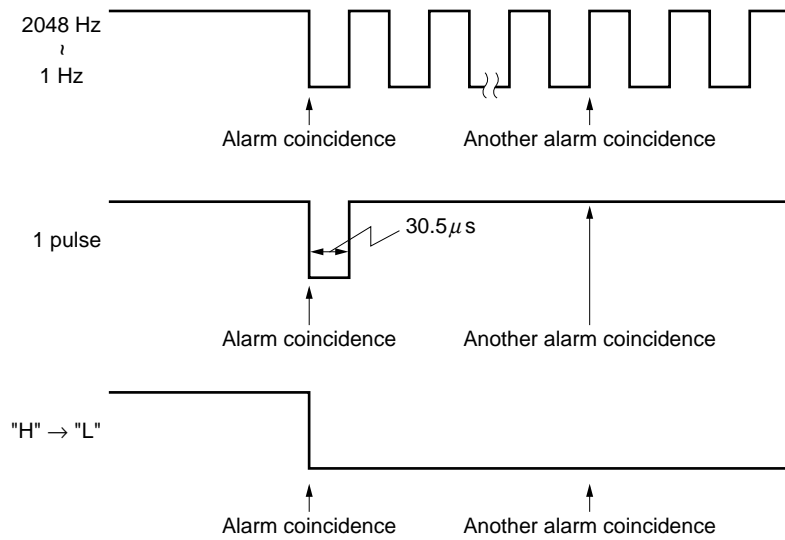

Fig. 4 TP<sub>1</sub> Output Waveform (without AUTO RESET)

Without RESET of the alarm coincidence flag



Figs. 5 and 6 show examples of applications using TP<sub>1</sub>.

Fig. 5 TP<sub>1</sub> Output Status (AUTO RESET mode)

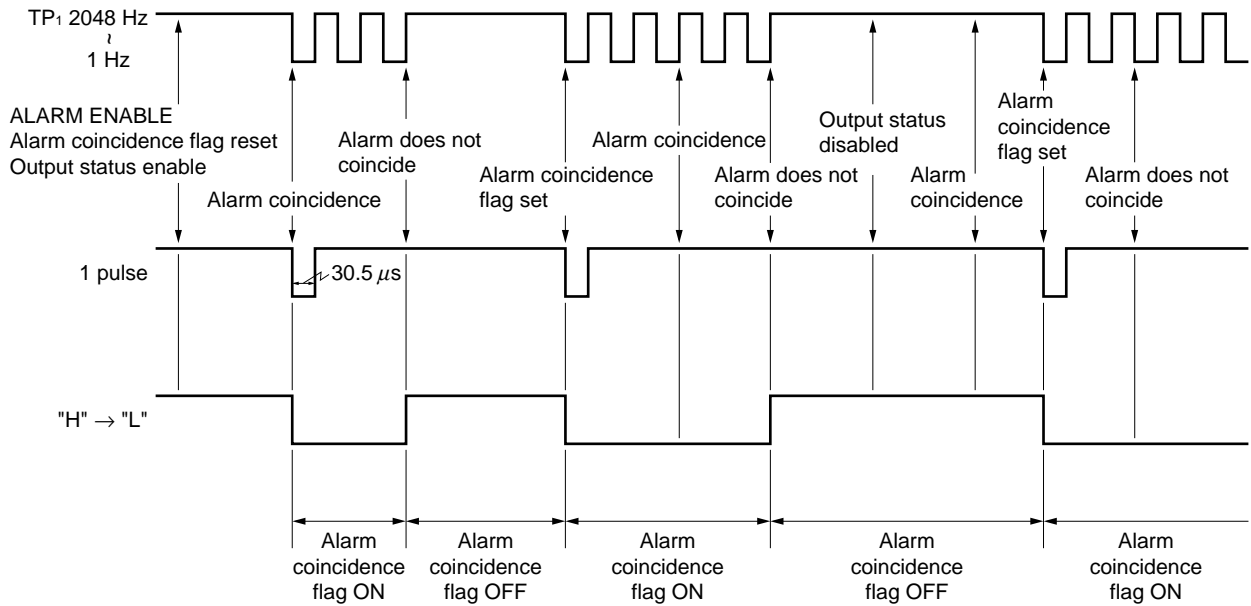
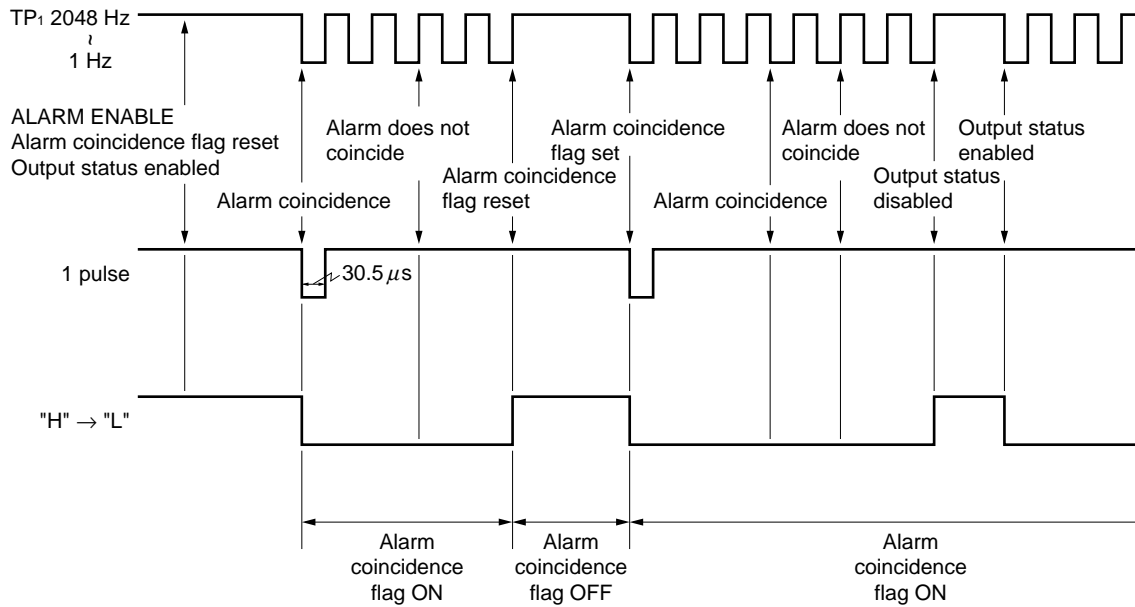

Fig. 6 TP<sub>1</sub> Output Status (without AUTO RESET)



**TP<sub>2</sub> SET (MODE = 0 \* 1 1 B)**

The TP<sub>2</sub> pin outputs an interval timer signal.

This signal is cyclically output.

The cycle at which the interval timer signal is output can be selected between 0.1 s, 1 s, 10 s, 30 s, and 60 s, depending on the contents indicated by the TP<sub>2</sub> CONTROL REGISTER. Note, however, that the 0.1-s cycle does not last exactly for 0.1 second, but that five 0.1-s cycles are equivalent to one 0.5 second.

If ±30 s ADJ, RESET is executed in mode (0, \*, 1, 1), an error occurs in the cycle.

Fig. 7 TP<sub>2</sub> Output Waveform

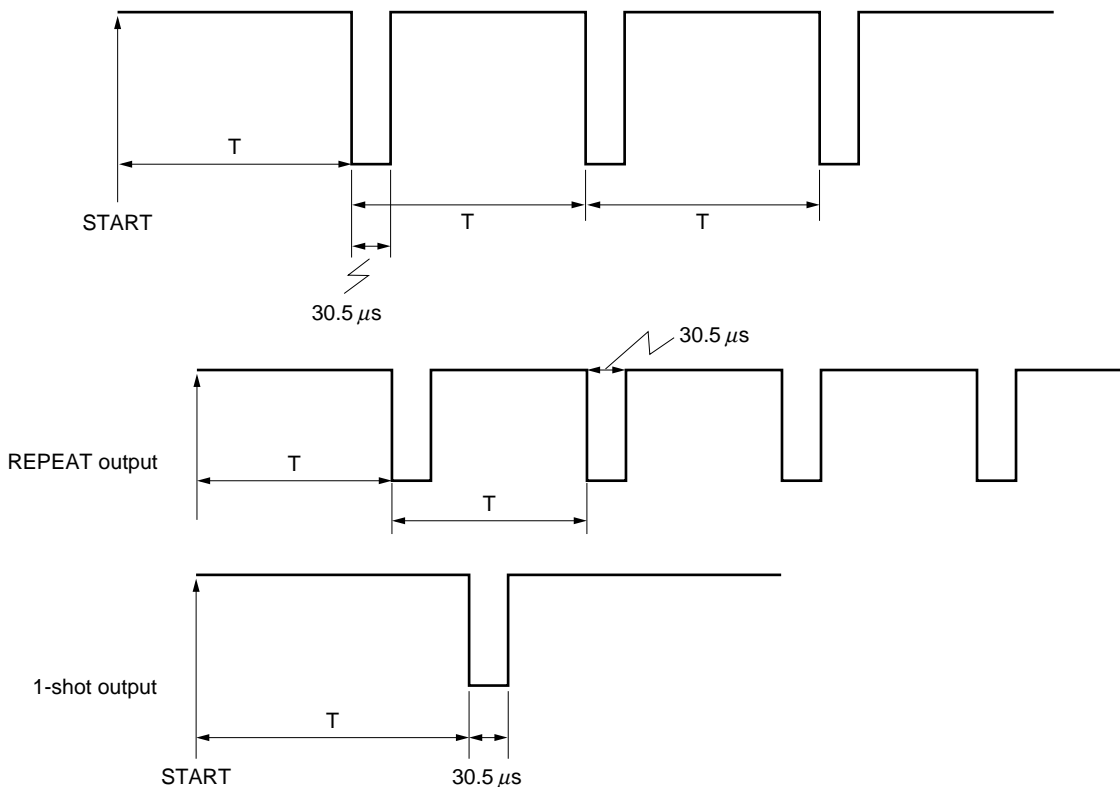

- BUSY output  
 The BUSY signal can be output to the TP<sub>1</sub> and TP<sub>2</sub> pins.  
 When output of the BUSY signal is specified, only the BUSY signal is output to the TP<sub>1</sub> and TP<sub>2</sub> pins.  
 The contents of the CONTROL REGISTER 2 are not affected, however.

**Fig. 8 BUSY Output Waveform**

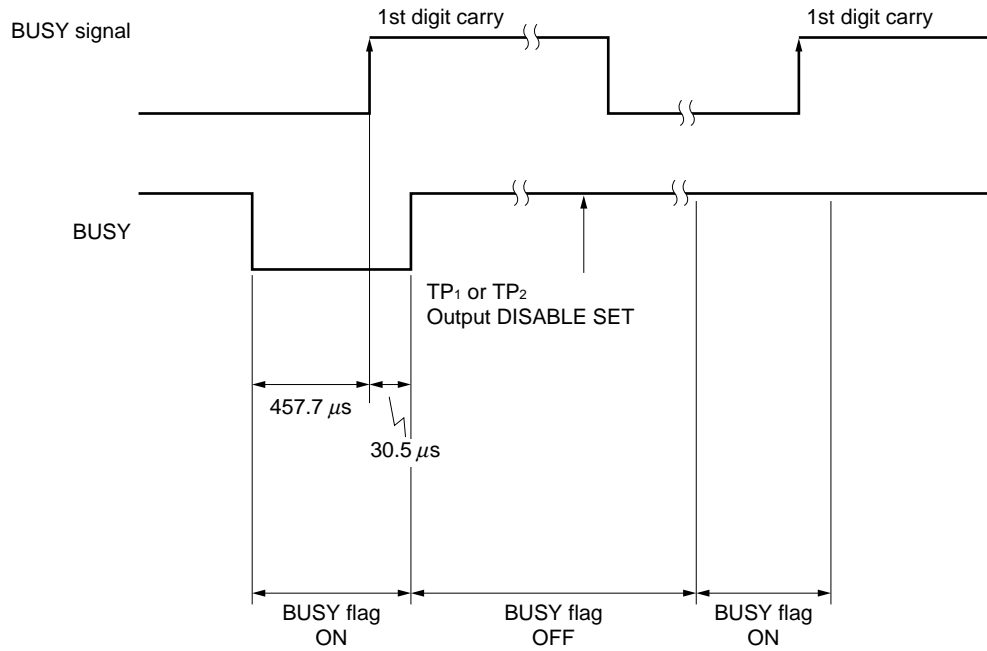
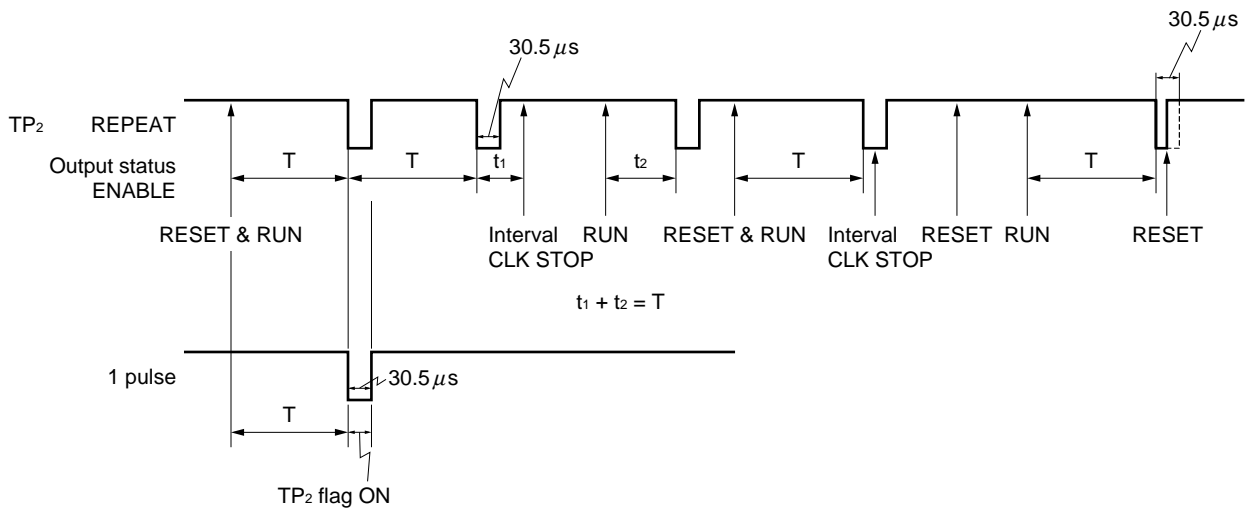

Fig. 9 shows an example of an application using TP<sub>2</sub>.

**Fig. 9 TP<sub>2</sub> Output Status**



**Note** When the output status is disabled, the signal goes "H" regardless of the status of TP<sub>2</sub>.

○ Oscillation characteristics

Figs. 11 and 12 show the frequency stability when the ambient temperature (T<sub>a</sub>) and supply voltage (V<sub>DD</sub>) are changed with a crystal of crystal impedance C<sub>1</sub> ≒ 20 kΩ and a circuit shown in Fig. 10.

The stability and day difference are calculated by the following expressions:

$$\text{Stability} = \frac{f - f_{\text{reference value}}}{f_{\text{reference value}}} \times 10^6 \text{ (ppm)}$$

**Note** f<sub>reference value</sub> in Fig. 12 is the measured frequency when V<sub>DD</sub> = 3.5 V.

$$\text{Day difference} = \left( \frac{1}{\text{TP1 specified frequency}} - \frac{1}{\text{measured frequency}} \right) \times 2 \text{ number of division stage} \times 60 \text{ seconds} \times 60 \text{ minutes} \times 24 \text{ hours (sec)}$$

**Note** The number of division stages = 11 at 2048 Hz.

**Fig. 10 Oscillation Characteristics Measuring Circuit**

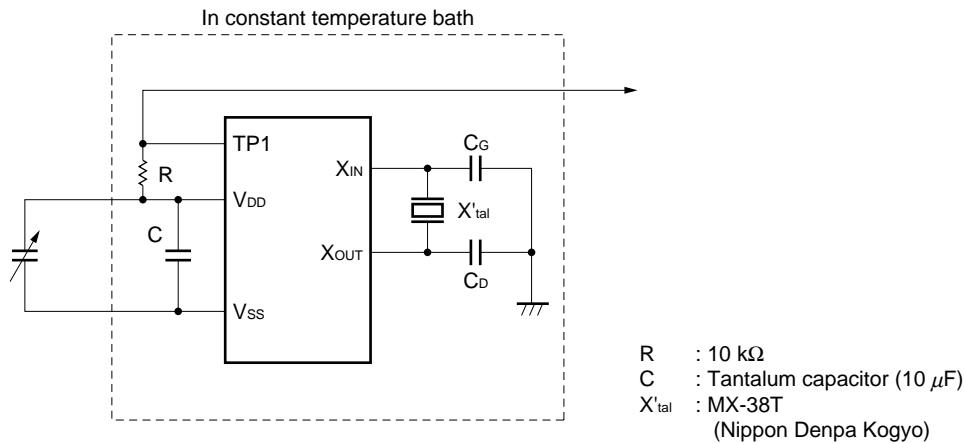

**Fig. 11 Frequency Stability vs. Temperature Characteristics**

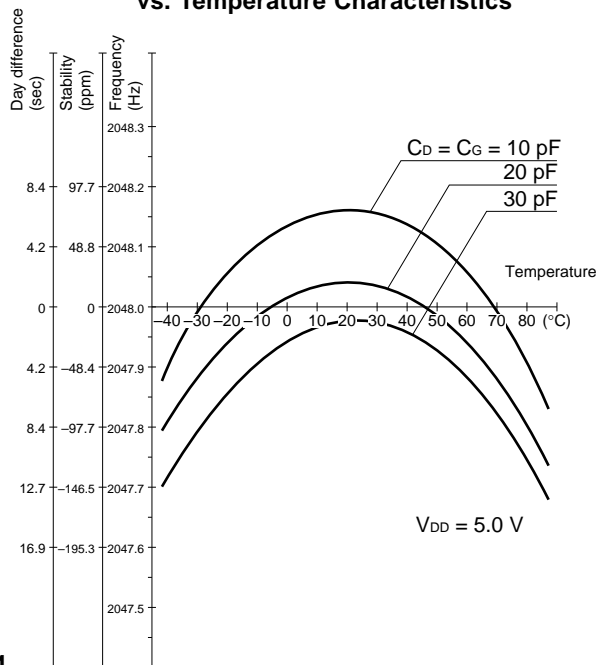

**Fig. 12 Frequency Stability vs. Supply Voltage Characteristics**

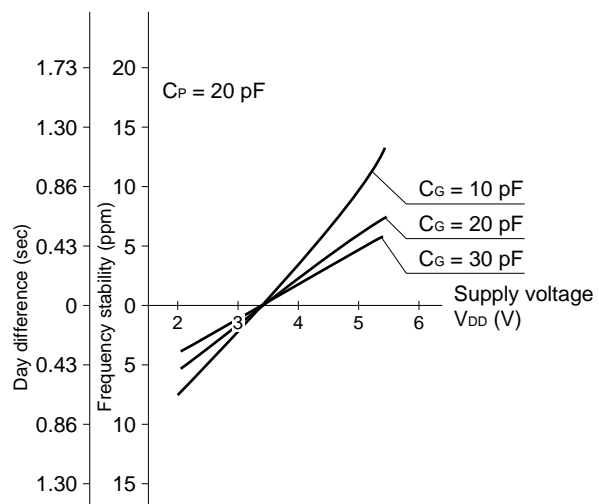
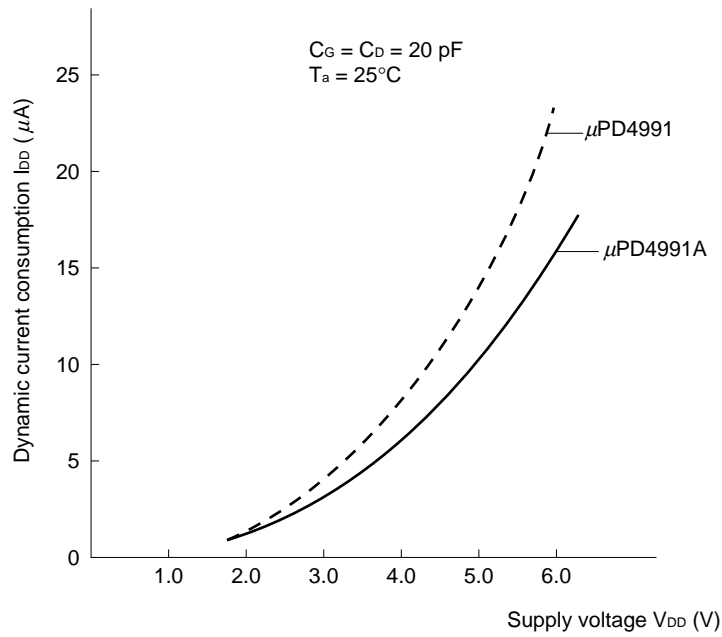



Fig. 13 Dynamic Current Consumption Characteristics



Differences between μPD4991 and μPD4991A

The μPD4991A improves on the characteristics of the μPD4991. These two products differ as follows:

1. Specifications

PARAMETER	SYMBOL	μPD4991	μPD4991A	REMARKS
Current Consumption	$I_{DD}$	20 $\mu\text{A}$ MAX.	14 $\mu\text{A}$ MAX.	$V_{DD} = 3.6 \text{ V}$
Current Consumption	$I_{DD}$	15 $\mu\text{A}$ MAX.	—	$V_{DD} = 3.0 \text{ V}$
Current Consumption	$I_{DD}$	—	6 $\mu\text{A}$ MAX.	$V_{DD} = 2.4 \text{ V}$
Input Data Setup Time	$t_{DW}$	0 ns MIN.	50 ns MIN.	Specifications differ
Input Data Hold Time	$t_{DH}$	0 ns MIN.	0 ns MIN.	Specifications differ

AC Timing of μPD4991

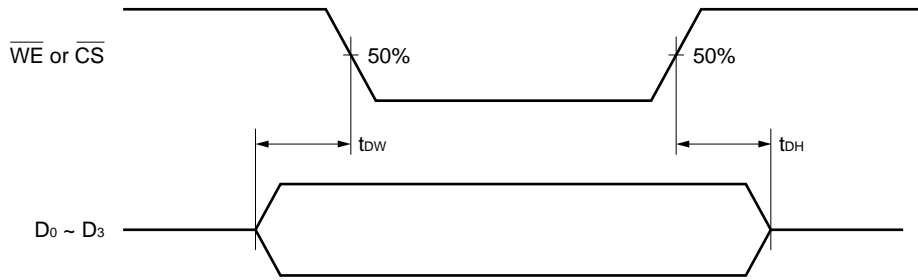

AC Timing of μPD4991A

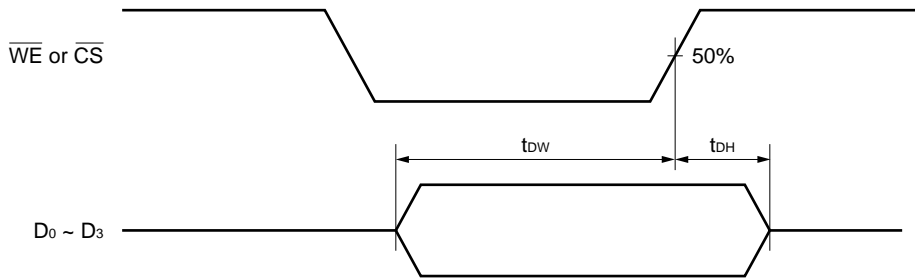

2. Function

PARAMETER	μPD4991	μPD4991A
Valid Range of ±30 s ADJUST	1-second to 1-minute digits (no carry to 10-minute digit)	All digits
BUSY Flag when ±30 s ADJUST	Not BUSY	BUSY until all digits are carried
D <sub>3</sub> bit of CONTROL REGISTER 1	NOP	CLOCK WAIT

**CLOCK WAIT Bit and CLOCK STOP Bit**

Both bits inhibit input of clock to the clock counter (1 Hz) and subsequently stop the clock. The CLOCK STOP bit is used to set the time to the clock (be sure to stop the clock when setting it). The CLOCK WAIT bit is used to prevent the CPU from reading wrong data in case counting takes place when the time is read (the time can also be read without the CLOCK WAIT bit but with the BUSY signal or by performing two reads). If the clock is run within 0.5 second after stopping the clock or placed in the wait state, no delay in respect to the actual time occurs.

Example of an Application Circuit

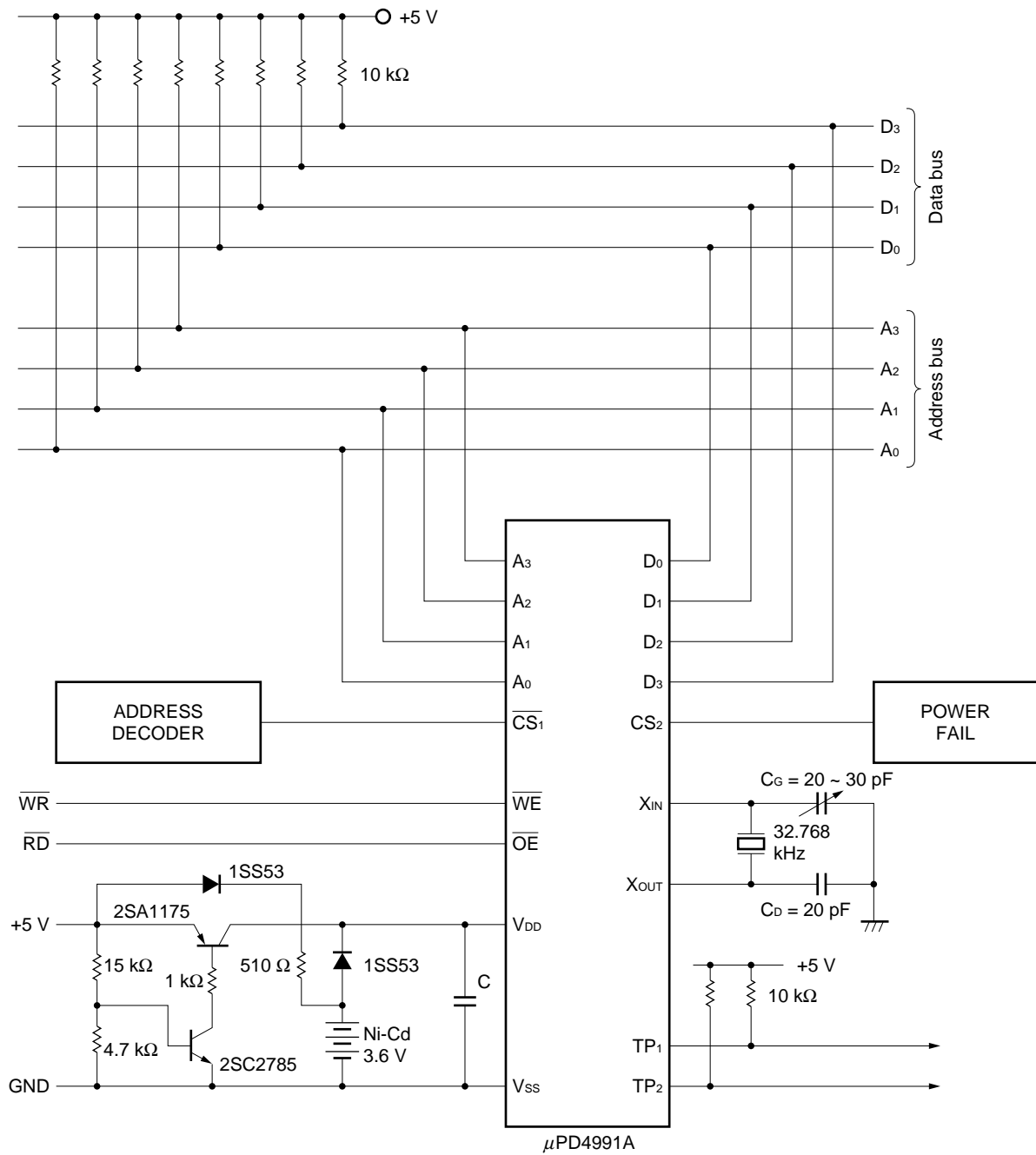

C: ceramic capacitor or tantalum capacitor  
(0.1 μF to 10 μF)

The application circuits and their parameters are for references only and are not intended for use in actual design-in's.

18PIN PLASTIC DIP (300 mil)

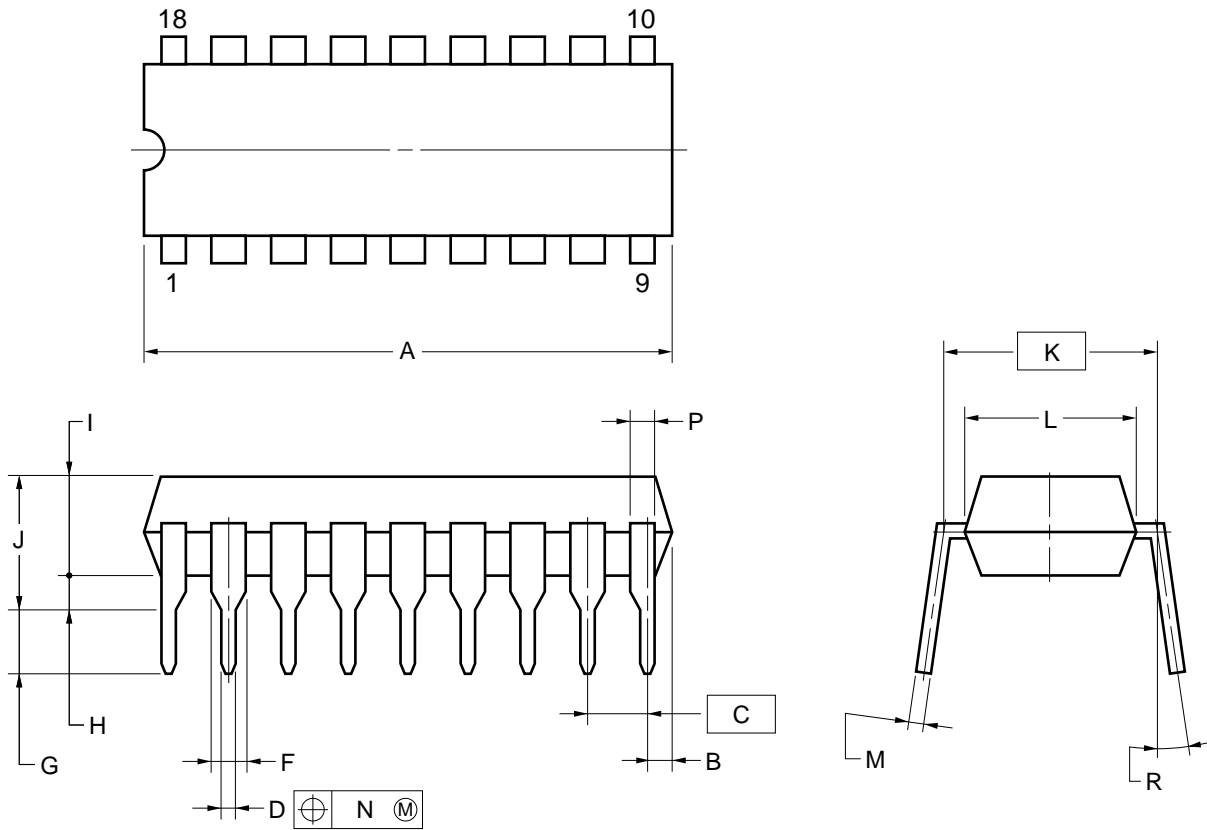

NOTES

- 1) Each lead centerline is located within 0.25 mm (0.01 inch) of its true position (T.P.) at maximum material condition.
- 2) Item "K" to center of leads when formed parallel.

ITEM	MILLIMETERS	INCHES
A	22.86 MAX.	0.900 MAX.
B	1.27 MAX.	0.050 MAX.
C	2.54 (T.P.)	0.100 (T.P.)
D	0.50±0.10	0.020 <sup>+0.004</sup> <sub>-0.005</sub>
F	1.2 MIN.	0.047 MIN.
G	3.5±0.3	0.138±0.012
H	0.51 MIN.	0.020 MIN.
I	4.31 MAX.	0.170 MAX.
J	5.08 MAX.	0.200 MAX.
K	7.62 (T.P.)	0.300 (T.P.)
L	6.4	0.252
M	0.25 <sup>+0.10</sup> <sub>-0.05</sub>	0.010 <sup>+0.004</sup> <sub>-0.003</sub>
N	0.25	0.01
P	1.0 MIN.	0.039 MIN.
R	0~15°	0~15°

P18C-100-300A,C-1

20 PIN PLASTIC SOP (300 mil)

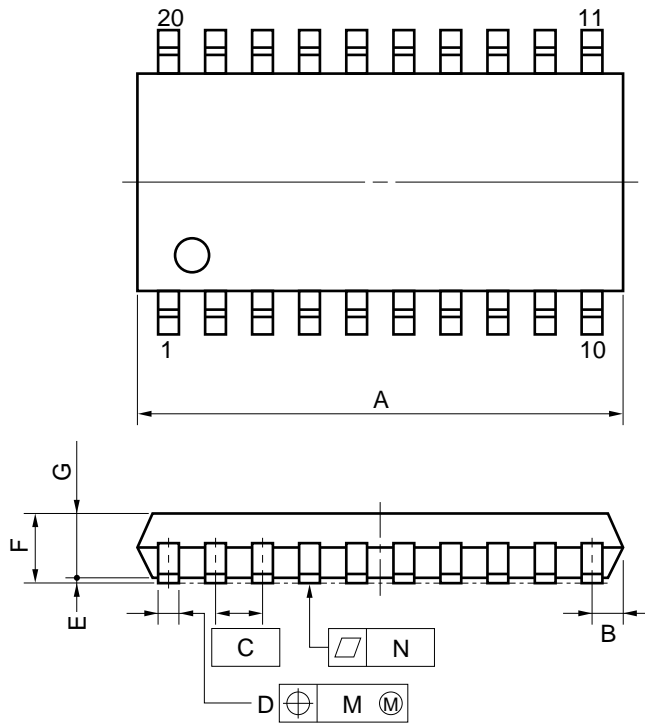

detail of lead end

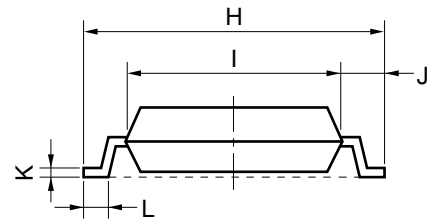
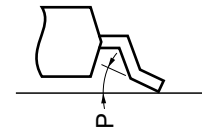

NOTE

Each lead centerline is located within 0.12 mm (0.005 inch) of its true position (T.P.) at maximum material condition.

ITEM	MILLIMETERS	INCHES
A	13.00 MAX.	0.512 MAX.
B	0.78 MAX.	0.031 MAX.
C	1.27 (T.P.)	0.050 (T.P.)
D	$0.40^{+0.10}_{-0.05}$	$0.016^{+0.004}_{-0.003}$
E	$0.1 \pm 0.1$	$0.004 \pm 0.004$
F	1.8 MAX.	0.071 MAX.
G	1.55	0.061
H	$7.7 \pm 0.3$	$0.303 \pm 0.012$
I	5.6	0.220
J	1.1	0.043
K	$0.20^{+0.10}_{-0.05}$	$0.008^{+0.004}_{-0.002}$
L	$0.6 \pm 0.2$	$0.024^{+0.008}_{-0.009}$
M	0.12	0.005
N	0.10	0.004
P	$3^{\circ+7^{\circ}}_{-3^{\circ}}$	$3^{\circ+7^{\circ}}_{-3^{\circ}}$

P20GM-50-300B, C-4

**RECOMMENDED SOLDERING CONDITIONS**

The following conditions must be met when soldering this product. Please consult with our sales offices when using other soldering process or under different conditions.

**Type of Surface Mounting Device**

μPD4991 AGS

Soldering process	Soldering conditions	Symbols
Infrared ray reflow	Peak temperature of package surface: 235 °C or below, Reflow time: 30 seconds or less (210 °C or higher), Number of reflow process: 2, Exposure limit*: None	IR35-00-2
VPS	Peak temperature of package surface: 215 °C or below, Reflow time: 40 seconds or less (200 °C or higher), Number of reflow process: 2, Exposure limit*: None	VP15-00-2
Wave soldering	Soldering temperature: 260 °C or below Flow time: 10 seconds or less, Number of reflow process: 1, Exposure limit*: None	WS60-00-1
Partial heating method	Pin temperature: 300 °C or below, Time: 10 seconds or below (per side of leads)	—

\* Exposure limit before soldering after dry-pack is opened.  
Storage condition: 25 °C and relative humidity at 65 % or less.

**Caution Do not apply more than a single process once, except for “Partial heating method.”**

**Type of Through-Hole Device**

μPD4991 ACX

Soldering process	Soldering conditions
Wave soldering	Soldering temperature: 260 °C or below

[MEMO]

## [MEMO]

No part of this document may be copied or reproduced in any form or by any means without the prior written consent of NEC Corporation. NEC Corporation assumes no responsibility for any errors which may appear in this document.

NEC Corporation does not assume any liability for infringement of patents, copyrights or other intellectual property rights of third parties by or arising from use of a device described herein or any other liability arising from use of such device. No license, either express, implied or otherwise, is granted under any patents, copyrights or other intellectual property rights of NEC Corporation or others.

While NEC Corporation has been making continuous effort to enhance the reliability of its semiconductor devices, the possibility of defects cannot be eliminated entirely. To minimize risks of damage or injury to persons or property arising from a defect in an NEC semiconductor device, customers must incorporate sufficient safety measures in its design, such as redundancy, fire-containment, and anti-failure features.

NEC devices are classified into the following three quality grades:

"Standard", "Special", and "Specific". The Specific quality grade applies only to devices developed based on a customer designated "quality assurance program" for a specific application. The recommended applications of a device depend on its quality grade, as indicated below. Customers must check the quality grade of each device before using it in a particular application.

Standard: Computers, office equipment, communications equipment, test and measurement equipment, audio and visual equipment, home electronic appliances, machine tools, personal electronic equipment and industrial robots

Special: Transportation equipment (automobiles, trains, ships, etc.), traffic control systems, anti-disaster systems, anti-crime systems, safety equipment and medical equipment (not specifically designed for life support)

Specific: Aircrafts, aerospace equipment, submersible repeaters, nuclear reactor control systems, life support systems or medical equipment for life support, etc.

The quality grade of NEC devices is "Standard" unless otherwise specified in NEC's Data Sheets or Data Books. If customers intend to use NEC devices for applications other than those specified for Standard quality grade, they should contact an NEC sales representative in advance.

Anti-radioactive design is not implemented in this product.