

# MITSUBISHI MICROCOMPUTERS M35071-XXXSP/FP

SCREEN CHARACTER and PATTERN DISPLAY CONTROLLERS

## DESCRIPTION

The M35071-XXXSP/FP is a character pattern display control IC can display on the CRT display the liquid crystal display and the plasma display. It can display 2 pages (24 characters × 12 lines per 1 page) at the same time. It uses a silicon gate CMOS process and it housed in a 20-pin shrink DIP package (M35071-XXXSP) or a 20-pin shrink SOP package (M35071-XXXFP).

For M35071-002SP/FP that is a standard ROM version of M35071-XXXSP/FP respectively, the character pattern is also mentioned.

## FEATURES

- Screen composition ..... 24 characters × 12 lines × 2 pages
- Number of characters displayed ..... 288 (Max.) × 2 pages
- Character composition ..... 12 × 18 dot matrix
- Characters available ..... page 0 : 256 characters  
page 1 : 128 characters
- Character sizes available ..... 4 (vertical) × 2 (horizontal)
- Display locations available
  - Horizontal direction ..... 2007 locations
  - Vertical direction ..... 1023 locations
- Blinking ..... Character units
  - Cycle : division of vertical synchronization signal into 32 or 64
  - Duty : 25%, 50%, or 75%
- Data input ..... By the I<sup>2</sup>C-BUS serial input function
- Coloring
  - Character color ..... Character unit
  - Background coloring ..... Character unit
  - Border (shadow) coloring ..... 8 colors (RGB output)  
Specified by register
  - Raster coloring ..... 8 colors (RGB output)  
Specified by register
- Blanking
  - Character size blanking
  - Border size blanking
  - Matrix-outline blanking
  - All blanking (all raster area)
- Output ports
  - 4 shared output ports (toggled between RGB output)
  - 4 dedicated output ports
- Display RAM erase function
- Display input frequency range ..... Fosc = 20MHz to 90MHz
- Horizontal synchronous input frequency  
..... H.sync = 15 kHz to 130 kHz
- Display oscillation stop function

## APPLICATION

CRT display, Liquid crystal display, Plasma display

## PIN CONFIGURATION (TOP VIEW)

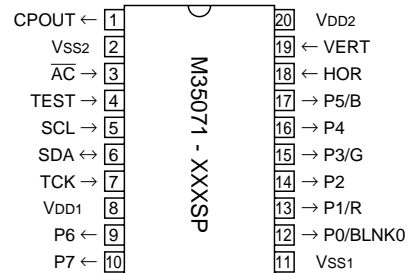

Outline 20P4B

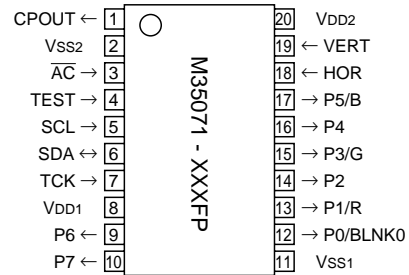

Outline 20P2Q-A

**PIN DESCRIPTION**

Pin Number	Symbol	Pin name	Input/Output	Function
1	CPOUT	Filter output	Output	Filter output. Connect loop filter to this pin.
2	VSS2	Earthing pin	–	Connect to GND.
3	$\overline{AC}$	Auto-clear input	Input	When “L”, this pin resets the internal IC circuit. Hysteresis input. Built-in pull-up resistor.
4	TEST	Test input	Input	Test pin. Connect to +5V.
5	SCL	Clock input	Input	SDA pin serial data is taken in when SCL rises. Hysteresis input.
6	SDA	Data I/O	I/O	This is the pin for serial input of display control register and display RAM data. Also, this pin output acknowledge signal. Hysteresis input. Nch opendrain output.
7	TCK	External clock	Input	This is the pin for external clock input.
8	VDD1	Power pin	–	Please connect to +5V with the power pin.
9	P6	Port P6 output	Output	This is the output port.
10	P7	Port P7 output	Output	This is the output port.
11	VSS1	Earthing pin	–	Please connect to GND using circuit earthing pin.
12	P0/BLNK0	Port P0 output	Output	This pin can be toggled between port pin output and BLNK0 signal output.
13	P1/R	Port P1 output	Output	This pin can be toggled between port pin output and R signal output.
14	P2	Port P2 output	Output	This is the output port.
15	P3/G	Port P3 output	Output	This pin can be toggled between port pin output and G signal output.
16	P4	Port P4 output	Output	This is the output port.
17	P5/B	Port P5 output	Output	This pin can be toggled between port pin output and B signal output.
18	HOR	Horizontal synchronous signal input	Input	This pin inputs the horizontal synchronous signal. Hysteresis input.
19	VERT	Vertical synchronous signal input	Input	This pin inputs the vertical synchronous signal. Hysteresis input.
20	VDD2	Power pin	–	Please connect to +5V with the power pin.

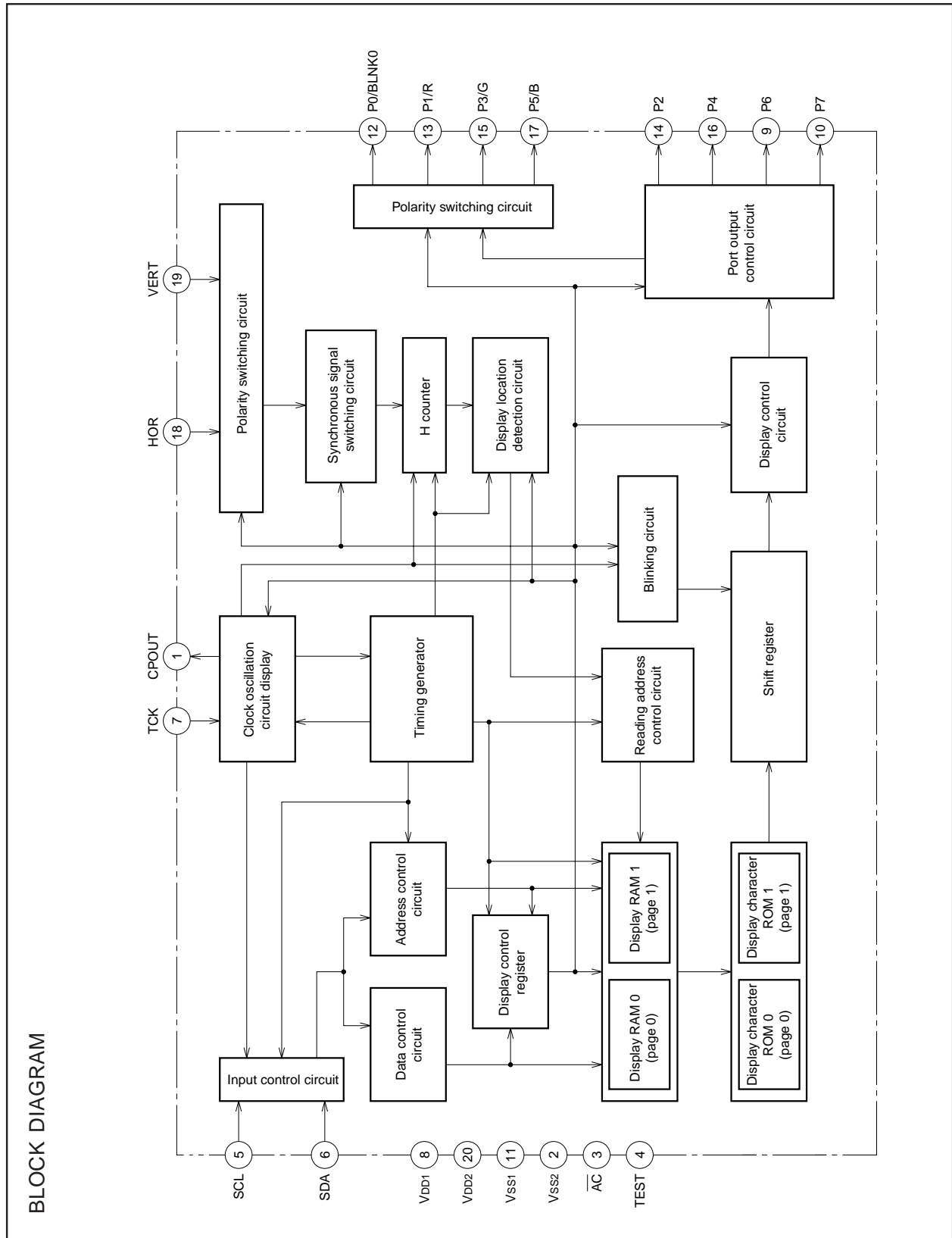

SCREEN CHARACTER and PATTERN DISPLAY CONTROLLERS

**MEMORY CONSTITUTION**

Address 000<sub>16</sub> to 11F<sub>16</sub> are assigned to the display RAM, address 120<sub>16</sub> to 128<sub>16</sub> are assigned to the display control registers. The internal circuit is reset and all display control registers (address 120<sub>16</sub> to 128<sub>16</sub>) are set to "0" when the  $\overline{AC}$  pin level is "L". And then, RAM is not erased and be undefined. This memory is consisted of 2

pages : page 0 memory and page 1 memory (their addresses are common), page controlled by DAF bit of each address when writing data. For detail, see "Data input". Memory constitution is shown in Figure 1 and 2.

Addresses	DAF	DAE	DAD	DAC	DAB	DAA	DA9	DA8	DA7	DA6	DA5	DA4	DA3	DA2	DA1	DA0
000 <sub>16</sub>	0	BB	BG	BR	BLINK	B	G	R	C7	C6	C5	C4	C3	C2	C1	C0
001 <sub>16</sub>	0	BB	BG	BR	BLINK	B	G	R	C7	C6	C5	C4	C3	C2	C1	C0
⋮	⋮	Background coloring			Blinking	Character color			Character code							
11E <sub>16</sub>	0	BB	BG	BR	BLINK	B	G	R	C7	C6	C5	C4	C3	C2	C1	C0
11F <sub>16</sub>	0	BB	BG	BR	BLINK	B	G	R	C7	C6	C5	C4	C3	C2	C1	C0
120 <sub>16</sub>	0	EXCK0	VJT	DIVS1	DIVS0	DIV10	DIV9	DIV8	DIV7	DIV6	DIV5	DIV4	DIV3	DIV2	DIV1	DIV0
121 <sub>16</sub>	0	RSEL0	PTD7	PTD6	PTD5	PTD4	PTD3	PTD2	PTD1	PTD0	PTC5	PTC4	PTC3	PTC2	PTC1	PTC0
122 <sub>16</sub>	0	RSEL1	SPACE2	SPACE1	SPACE0	HP10	HP9	HP8	HP7	HP6	HP5	HP4	HP3	HP2	HP1	HP0
123 <sub>16</sub>	0	EXCK1	TEST3	TEST2	TEST1	TEST0	VP9	VP8	VP7	VP6	VP5	VP4	VP3	VP2	VP1	VP0
124 <sub>16</sub>	0	TEST9	TEST5	TEST4	DSP11	DSP10	DSP9	DSP8	DSP7	DSP6	DSP5	DSP4	DSP3	DSP2	DSP1	DSP0
125 <sub>16</sub>	0	TEST10	VSZ1H1	VSZ1H0	VSZ1L1	VSZ1L0	V1SZ1	V1SZ0	LIN9	LIN8	LIN7	LIN6	LIN5	LIN4	LIN3	LIN2
126 <sub>16</sub>	0	POPUP	VSZ2H1	VSZ2H0	VSZ2L1	VSZ2L0	V18SZ1	V18SZ0	LIN17	LIN16	LIN15	LIN14	LIN13	LIN12	LIN11	LIN10
127 <sub>16</sub>	0	MODE0	TEST12	HSZ20	TEST11	HSZ10	BETA14	TEST8	TEST7	TEST6	FB	FG	FR	RB	RG	RR
128 <sub>16</sub>	0	MODE1	BLINK2	BLINK1	BLINK0	DSPON	STOP	RAMERS	SYAD	BLK1	BLK0	POLH	POLV	VMASK	B/F	BCOL

Fig. 1 Memory constitution (page 0 memory)

SCREEN CHARACTER and PATTERN DISPLAY CONTROLLERS

Addresses	DAF	DAE	DAD	DAC	DAB	DAA	DA9	DA8	DA7	DA6	DA5	DA4	DA3	DA2	DA1	DA0
000 <sub>16</sub>	1	BB	BG	BR	BLINK	B	G	R	0	C6	C5	C4	C3	C2	C1	C0
001 <sub>16</sub>	1	BB	BG	BR	BLINK	B	G	R	0	C6	C5	C4	C3	C2	C1	C0
⋮	⋮	Background coloring			Blinking	Character color			⋮	Character code						
11E <sub>16</sub>	1	BB	BG	BR	BLINK	B	G	R	0	C6	C5	C4	C3	C2	C1	C0
11F <sub>16</sub>	1	BB	BG	BR	BLINK	B	G	R	0	C6	C5	C4	C3	C2	C1	C0
120 <sub>16</sub>	1	-	-	-	-	-	-	-	-	-	-	-	-	-	-	-
121 <sub>16</sub>	1	-	-	-	-	-	-	-	-	-	-	-	-	-	-	-
122 <sub>16</sub>	1	-	SPACE2	SPACE1	SPACE0	HP10	HP9	HP8	HP7	HP6	HP5	HP4	HP3	HP2	HP1	HP0
123 <sub>16</sub>	1	-	TEST3	TEST2	TEST1	TEST0	VP9	VP8	VP7	VP6	VP5	VP4	VP3	VP2	VP1	VP0
124 <sub>16</sub>	1	-	-	TEST4	DSP11	DSP10	DSP9	DSP8	DSP7	DSP6	DSP5	DSP4	DSP3	DSP2	DSP1	DSP0
125 <sub>16</sub>	1	-	VSZ1H1	VSZ1H0	VSZ1L1	VSZ1L0	V1SZ1	V1SZ0	LIN9	LIN8	LIN7	LIN6	LIN5	LIN4	LIN3	LIN2
126 <sub>16</sub>	1	-	VSZ2H1	VSZ2H0	VSZ2L1	VSZ2L0	V18SZ1	V18SZ0	LIN17	LIN16	LIN15	LIN14	LIN13	LIN12	LIN11	LIN10
127 <sub>16</sub>	1	-	TEST12	HSZ20	TEST11	HSZ10	BETA14	TEST8	TEST7	TEST6	FB	FG	FR	RB	RG	RR
128 <sub>16</sub>	1	-	BLINK2	BLINK1	BLINK0	DSPON	TEST13	RAMERS	SYAD	BLK1	BLK0	-	-	-	-	BCOL

Fig. 2 Memory constitution (page 1 memory)

Note: Page 0 and page 1 registers are found in their respective pages. For example, HP10 to HP0 of the page 0 memory sets the horizontal display start position of page 0, whereas HP10 to HP0 (same register name) of the page 1 memory sets the horizontal display start position of page 1. Also, registers common to both page 0 and page 1 are found only in the page 0 memory. For example, PTC0 is the control register of the P0 pin and is found only in the page 0 memory.

**SCREEN CONSTITUTION**

The screen lines and rows are determined from each address of the display RAM (page 0 and page 1 are common). The screen constitution is shown in Figure 3.

Row Line	1	2	3	4	5	6	7	8	9	10	11	12	13	14	15	16	17	18	19	20	21	22	23	24
1	000 <sub>16</sub>	001 <sub>16</sub>	002 <sub>16</sub>	003 <sub>16</sub>	004 <sub>16</sub>	005 <sub>16</sub>	006 <sub>16</sub>	007 <sub>16</sub>	008 <sub>16</sub>	009 <sub>16</sub>	00A <sub>16</sub>	00B <sub>16</sub>	00C <sub>16</sub>	00D <sub>16</sub>	00E <sub>16</sub>	00F <sub>16</sub>	010 <sub>16</sub>	011 <sub>16</sub>	012 <sub>16</sub>	013 <sub>16</sub>	014 <sub>16</sub>	015 <sub>16</sub>	016 <sub>16</sub>	017 <sub>16</sub>
2	018 <sub>16</sub>	019 <sub>16</sub>	01A <sub>16</sub>	01B <sub>16</sub>	01C <sub>16</sub>	01D <sub>16</sub>	01E <sub>16</sub>	01F <sub>16</sub>	020 <sub>16</sub>	021 <sub>16</sub>	022 <sub>16</sub>	023 <sub>16</sub>	024 <sub>16</sub>	025 <sub>16</sub>	026 <sub>16</sub>	027 <sub>16</sub>	028 <sub>16</sub>	029 <sub>16</sub>	02A <sub>16</sub>	02B <sub>16</sub>	02C <sub>16</sub>	02D <sub>16</sub>	02E <sub>16</sub>	02F <sub>16</sub>
3	030 <sub>16</sub>	031 <sub>16</sub>	032 <sub>16</sub>	033 <sub>16</sub>	034 <sub>16</sub>	035 <sub>16</sub>	036 <sub>16</sub>	037 <sub>16</sub>	038 <sub>16</sub>	039 <sub>16</sub>	03A <sub>16</sub>	03B <sub>16</sub>	03C <sub>16</sub>	03D <sub>16</sub>	03E <sub>16</sub>	03F <sub>16</sub>	040 <sub>16</sub>	041 <sub>16</sub>	042 <sub>16</sub>	043 <sub>16</sub>	044 <sub>16</sub>	045 <sub>16</sub>	046 <sub>16</sub>	047 <sub>16</sub>
4	048 <sub>16</sub>	049 <sub>16</sub>	04A <sub>16</sub>	04B <sub>16</sub>	04C <sub>16</sub>	04D <sub>16</sub>	04E <sub>16</sub>	04F <sub>16</sub>	050 <sub>16</sub>	051 <sub>16</sub>	052 <sub>16</sub>	053 <sub>16</sub>	054 <sub>16</sub>	055 <sub>16</sub>	056 <sub>16</sub>	057 <sub>16</sub>	058 <sub>16</sub>	059 <sub>16</sub>	05A <sub>16</sub>	05B <sub>16</sub>	05C <sub>16</sub>	05D <sub>16</sub>	05E <sub>16</sub>	05F <sub>16</sub>
5	060 <sub>16</sub>	061 <sub>16</sub>	062 <sub>16</sub>	063 <sub>16</sub>	064 <sub>16</sub>	065 <sub>16</sub>	066 <sub>16</sub>	067 <sub>16</sub>	068 <sub>16</sub>	069 <sub>16</sub>	06A <sub>16</sub>	06B <sub>16</sub>	06C <sub>16</sub>	06D <sub>16</sub>	06E <sub>16</sub>	06F <sub>16</sub>	070 <sub>16</sub>	071 <sub>16</sub>	072 <sub>16</sub>	073 <sub>16</sub>	074 <sub>16</sub>	075 <sub>16</sub>	076 <sub>16</sub>	077 <sub>16</sub>
6	078 <sub>16</sub>	079 <sub>16</sub>	07A <sub>16</sub>	07B <sub>16</sub>	07C <sub>16</sub>	07D <sub>16</sub>	07E <sub>16</sub>	07F <sub>16</sub>	080 <sub>16</sub>	081 <sub>16</sub>	082 <sub>16</sub>	083 <sub>16</sub>	084 <sub>16</sub>	085 <sub>16</sub>	086 <sub>16</sub>	087 <sub>16</sub>	088 <sub>16</sub>	089 <sub>16</sub>	08A <sub>16</sub>	08B <sub>16</sub>	08C <sub>16</sub>	08D <sub>16</sub>	08E <sub>16</sub>	08F <sub>16</sub>
7	090 <sub>16</sub>	091 <sub>16</sub>	092 <sub>16</sub>	093 <sub>16</sub>	094 <sub>16</sub>	095 <sub>16</sub>	096 <sub>16</sub>	097 <sub>16</sub>	098 <sub>16</sub>	099 <sub>16</sub>	09A <sub>16</sub>	09B <sub>16</sub>	09C <sub>16</sub>	09D <sub>16</sub>	09E <sub>16</sub>	09F <sub>16</sub>	0A0 <sub>16</sub>	0A1 <sub>16</sub>	0A2 <sub>16</sub>	0A3 <sub>16</sub>	0A4 <sub>16</sub>	0A5 <sub>16</sub>	0A6 <sub>16</sub>	0A7 <sub>16</sub>
8	0A8 <sub>16</sub>	0A9 <sub>16</sub>	0AA <sub>16</sub>	0AB <sub>16</sub>	0AC <sub>16</sub>	0AD <sub>16</sub>	0AE <sub>16</sub>	0AF <sub>16</sub>	0B0 <sub>16</sub>	0B1 <sub>16</sub>	0B2 <sub>16</sub>	0B3 <sub>16</sub>	0B4 <sub>16</sub>	0B5 <sub>16</sub>	0B6 <sub>16</sub>	0B7 <sub>16</sub>	0B8 <sub>16</sub>	0B9 <sub>16</sub>	0BA <sub>16</sub>	0BB <sub>16</sub>	0BC <sub>16</sub>	0BD <sub>16</sub>	0BE <sub>16</sub>	0BF <sub>16</sub>
9	0C0 <sub>16</sub>	0C1 <sub>16</sub>	0C2 <sub>16</sub>	0C3 <sub>16</sub>	0C4 <sub>16</sub>	0C5 <sub>16</sub>	0C6 <sub>16</sub>	0C7 <sub>16</sub>	0C8 <sub>16</sub>	0C9 <sub>16</sub>	0CA <sub>16</sub>	0CB <sub>16</sub>	0CC <sub>16</sub>	0CD <sub>16</sub>	0CE <sub>16</sub>	0CF <sub>16</sub>	0D0 <sub>16</sub>	0D1 <sub>16</sub>	0D2 <sub>16</sub>	0D3 <sub>16</sub>	0D4 <sub>16</sub>	0D5 <sub>16</sub>	0D6 <sub>16</sub>	0D7 <sub>16</sub>
10	0D8 <sub>16</sub>	0D9 <sub>16</sub>	0DA <sub>16</sub>	0DB <sub>16</sub>	0DC <sub>16</sub>	0DD <sub>16</sub>	0DE <sub>16</sub>	0DF <sub>16</sub>	0E0 <sub>16</sub>	0E1 <sub>16</sub>	0E2 <sub>16</sub>	0E3 <sub>16</sub>	0E4 <sub>16</sub>	0E5 <sub>16</sub>	0E6 <sub>16</sub>	0E7 <sub>16</sub>	0E8 <sub>16</sub>	0E9 <sub>16</sub>	0EA <sub>16</sub>	0EB <sub>16</sub>	0EC <sub>16</sub>	0ED <sub>16</sub>	0EE <sub>16</sub>	0EF <sub>16</sub>
11	0F0 <sub>16</sub>	0F1 <sub>16</sub>	0F2 <sub>16</sub>	0F3 <sub>16</sub>	0F4 <sub>16</sub>	0F5 <sub>16</sub>	0F6 <sub>16</sub>	0F7 <sub>16</sub>	0F8 <sub>16</sub>	0F9 <sub>16</sub>	0FA <sub>16</sub>	0FB <sub>16</sub>	0FC <sub>16</sub>	0FD <sub>16</sub>	0FE <sub>16</sub>	0FF <sub>16</sub>	100 <sub>16</sub>	101 <sub>16</sub>	102 <sub>16</sub>	103 <sub>16</sub>	104 <sub>16</sub>	105 <sub>16</sub>	106 <sub>16</sub>	107 <sub>16</sub>
12	108 <sub>16</sub>	109 <sub>16</sub>	10A <sub>16</sub>	10B <sub>16</sub>	10C <sub>16</sub>	10D <sub>16</sub>	10E <sub>16</sub>	10F <sub>16</sub>	110 <sub>16</sub>	111 <sub>16</sub>	112 <sub>16</sub>	113 <sub>16</sub>	114 <sub>16</sub>	115 <sub>16</sub>	116 <sub>16</sub>	117 <sub>16</sub>	118 <sub>16</sub>	119 <sub>16</sub>	11A <sub>16</sub>	11B <sub>16</sub>	11C <sub>16</sub>	11D <sub>16</sub>	11E <sub>16</sub>	11F <sub>16</sub>

\* The hexadecimal numbers in the boxes show the display RAM address.

Fig. 3 Screen constitution

**DISPLAY RAM**

Address 000<sub>16</sub> to 11F<sub>16</sub>

DA	Register	Contents		Remarks																																				
		Status	Function																																					
0	C0	0	Set the displayed ROM character code.	Set display character																																				
		1																																						
1	C1	0	To write data into page 0 (Note 2), select the data from the ROM characters (256 types) for page 0 and set the character code. To write data into page 1, do the same from the ROM characters (128 types) for page 1.																																					
		1																																						
2	C2	0																																						
		1																																						
3	C3	0																																						
		1																																						
4	C4	0																																						
		1																																						
5	C5	0																																						
		1																																						
6	C6	0																																						
		1																																						
7	C7	0		It should to be fixed to "0" to C7 when page 1 setting (Note 3).																																				
		1																																						
8	R	0	<table border="1"> <thead> <tr> <th>B</th> <th>G</th> <th>R</th> <th>Color</th> </tr> </thead> <tbody> <tr> <td>0</td> <td>0</td> <td>0</td> <td>Black</td> </tr> <tr> <td>0</td> <td>0</td> <td>1</td> <td>Red</td> </tr> <tr> <td>0</td> <td>1</td> <td>0</td> <td>Green</td> </tr> <tr> <td>0</td> <td>1</td> <td>1</td> <td>Yellow</td> </tr> <tr> <td>1</td> <td>0</td> <td>0</td> <td>Blue</td> </tr> <tr> <td>1</td> <td>0</td> <td>1</td> <td>Magenta</td> </tr> <tr> <td>1</td> <td>1</td> <td>0</td> <td>Cyan</td> </tr> <tr> <td>1</td> <td>1</td> <td>1</td> <td>White</td> </tr> </tbody> </table>	B	G	R	Color	0	0	0	Black	0	0	1	Red	0	1	0	Green	0	1	1	Yellow	1	0	0	Blue	1	0	1	Magenta	1	1	0	Cyan	1	1	1	White	Set character color (character unit)
		B		G	R	Color																																		
0	0	0		Black																																				
0	0	1		Red																																				
0	1	0		Green																																				
0	1	1		Yellow																																				
1	0	0		Blue																																				
1	0	1		Magenta																																				
1	1	0		Cyan																																				
1	1	1		White																																				
1																																								
9	G	0																																						
		1																																						
A	B	0																																						
		1																																						
B	BLINK	0	Do not blink.	Set blinking See register BLINK2 to BLINK0 (address128 <sub>16</sub> )																																				
		1	Blinking																																					
C	BR	0	<table border="1"> <thead> <tr> <th>BB</th> <th>BG</th> <th>BR</th> <th>Color</th> </tr> </thead> <tbody> <tr> <td>0</td> <td>0</td> <td>0</td> <td>Black</td> </tr> <tr> <td>0</td> <td>0</td> <td>1</td> <td>Red</td> </tr> <tr> <td>0</td> <td>1</td> <td>0</td> <td>Green</td> </tr> <tr> <td>0</td> <td>1</td> <td>1</td> <td>Yellow</td> </tr> <tr> <td>1</td> <td>0</td> <td>0</td> <td>Blue</td> </tr> <tr> <td>1</td> <td>0</td> <td>1</td> <td>Magenta</td> </tr> <tr> <td>1</td> <td>1</td> <td>0</td> <td>Cyan</td> </tr> <tr> <td>1</td> <td>1</td> <td>1</td> <td>White</td> </tr> </tbody> </table>	BB	BG	BR	Color	0	0	0	Black	0	0	1	Red	0	1	0	Green	0	1	1	Yellow	1	0	0	Blue	1	0	1	Magenta	1	1	0	Cyan	1	1	1	White	Set character background (character unit)
		BB		BG	BR	Color																																		
0	0	0		Black																																				
0	0	1		Red																																				
0	1	0		Green																																				
0	1	1		Yellow																																				
1	0	0		Blue																																				
1	0	1		Magenta																																				
1	1	0		Cyan																																				
1	1	1		White																																				
1																																								
D	BG	0																																						
		1																																						
E	BB	0																																						
		1																																						

- Notes 1. The display RAM is undefined state at the AC pin.  
 2. The display RAM consists of 2 pages, page 0 and page 1 (common address). The page in which data is written is controlled by the DAF bit. When set to "0", data is written into page 0, whereas when set to "1", data is written into page 1.  
 3. However, set "1" only when using the "FF<sub>16</sub>" blank code as the text code.

**REGISTERS DESCRIPTION**

(1) Address 120<sub>16</sub>

DA	Register	Contents		Remarks															
		Status	Function																
0	DIV0 (Note 3)	0	Set division value (multiply value) of horizontal oscillation frequency.	Set display frequency by division value (multiply value) setting. For details, see REGISTER SUPPLYMENTARY DESCRIPTION (1).  Also, set the display frequency range by registers DIVS0, DIVS1(address 120 <sub>16</sub> ), RSEL0(address 121 <sub>16</sub> ) and RSEL1(address 122 <sub>16</sub> ) in accordance with the display frequency.  Any of this settings above is required only when EXCK1 = 0, EXCK0 = 1 and EXCK1 = 1, EXCK0 = 1.															
		1																	
1	DIV1 (Note 3)	0	$N1 = \sum_{n=0}^{10} (DIVn \times 2^n)$																
		1																	
2	DIV2 (Note 3)	0	N1 : division value (multiply value)																
		1																	
3	DIV3 (Note 3)	0																	
		1																	
4	DIV4 (Note 3)	0																	
		1																	
5	DIV5 (Note 3)	0																	
		1																	
6	DIV6 (Note 3)	0																	
		1																	
7	DIV7 (Note 3)	0																	
		1																	
8	DIV8 (Note 3)	0																	
		1																	
9	DIV9 (Note 3)	0																	
		1																	
A	DIV10 (Note 3)	0																	
		1																	
B	DIVS0 (Note 3)	0	For setting, see REGISTER SUPPLYMENTARY DESCRIPTION (2).	Set display frequency range.															
		1																	
C	DIVS1 (Note 3)	0																	
		1																	
D	VJT (Note 3)	0	It is used to "0A", normally.																
		1	Alleviates continuous vertical jitters.																
E	EXCK0 (Note 3)	0	<table border="1"> <thead> <tr> <th>EXCK1</th> <th>EXCK0</th> <th>Display clock input</th> </tr> </thead> <tbody> <tr> <td>0</td> <td>0</td> <td>External synchronous (external clock)</td> </tr> <tr> <td>0</td> <td>1</td> <td>Internal synchronous</td> </tr> <tr> <td>1</td> <td>0</td> <td>Do not set</td> </tr> <tr> <td>1</td> <td>1</td> <td>External synchronous (internal clock)</td> </tr> </tbody> </table>	EXCK1	EXCK0	Display clock input	0	0	External synchronous (external clock)	0	1	Internal synchronous	1	0	Do not set	1	1	External synchronous (internal clock)	Display clock setting See REGISTER SUPPLYMENTARY DESCRIPTION (1) EXCK1 : address 123 <sub>16</sub>
		EXCK1	EXCK0	Display clock input															
0	0	External synchronous (external clock)																	
0	1	Internal synchronous																	
1	0	Do not set																	
1	1	External synchronous (internal clock)																	
1																			

Notes 1. The mark 0 around the status value means the reset status by the "L" level is input to AC pin.

2. The page in which data is written is controlled by the DAF bit. When set to "0", data is written into page 0, whereas when set to "1", data is written into page 1.

3. Registers marked with (Note 3) are found only in page 0, therefore the register value does not change when the DAF bit is set to "1".



SCREEN CHARACTER and PATTERN DISPLAY CONTROLLERS

(2) Address 121<sub>16</sub>

DA	Register	Contents		Remarks
		Status	Function	
0	PTC0 (Note 3)	0	P0 output (port P0).	P0 pin output control.
		1	BLNK0 output.	
1	PTC1 (Note 3)	0	P1 output (port P1).	P1 pin output control.
		1	R signal output.	
2	PTC2 (Note 3)	0	P2 output (port P2).	P2 pin output control.
		1	Can not be used.	
3	PTC3 (Note 3)	0	P3 output (port P3).	P3 pin output control.
		1	G signal output.	
4	PTC4 (Note 3)	0	P4 output (port P4).	P4 pin output control.
		1	Can not be used.	
5	PTC5 (Note 3)	0	P5 output (port P5).	P5 pin output control.
		1	B signal output.	
6	PTD0 (Note 3)	0	"L" output or negative polarity output (BLNK0 output).	P0 pin data control.
		1	"H" output or positive polarity output (BLNK0 output).	
7	PTD1 (Note 3)	0	"L" output or negative polarity output (R signal output).	P1 pin data control.
		1	"H" output or positive polarity output (R signal output).	
8	PTD2 (Note 3)	0	"L" output.	P2 pin data control.
		1	"H" output.	
9	PTD3 (Note 3)	0	"L" output or negative polarity output (G signal output).	P3 pin data control.
		1	"H" output or positive polarity output (G signal output).	
A	PTD4 (Note 3)	0	"L" output.	P4 pin data control.
		1	"H" output.	
B	PTD5 (Note 3)	0	"L" output or negative polarity output (B signal output).	P5 pin data control.
		1	"H" output or positive polarity output (B signal output).	
C	PTD6 (Note 3)	0	"L" output.	P6 pin data control.
		1	"H" output.	
D	PTD7 (Note 3)	0	"L" output.	P7 pin data control.
		1	"H" output.	
E	RSEL0 (Note 3)	0	For setting, see REGISTER SUPPLYMENTARY DESCRIPTION (2).	Set display frequency range.
		1		

Notes 1. The mark 0 around the status value means the reset status by the "L" level is input to AC pin.

2. The page in which data is written is controlled by the DAF bit. When set to "0", data is written into page 0, whereas when set to "1", data is written into page 1.
3. Registers marked with (Note 3) are found only in page 0, therefore the register value does not change when the DAF bit is set to "1".

SCREEN CHARACTER and PATTERN DISPLAY CONTROLLERS

(3) Address 122<sub>16</sub>

DA	Register	Contents		Remarks																																							
		Status	Function																																								
0	HP0	0	If HS is the horizontal display start location, $HS = T \times \left( \sum_{n=0}^{10} 2^n HP_n + 6 \right)$	Horizontal display start location is specified using the 11 bits from HP10 to HP0. HP10 to HP0 = (000000000002) and (000001001112) setting is forbidden.																																							
		1																																									
1	HP1	0	T : Period of display frequency 2007 settings are possible.																																								
		1																																									
2	HP2	0																																									
		1																																									
3	HP3	0																																									
		1																																									
4	HP4	0																																									
		1																																									
5	HP5	0																																									
		1																																									
6	HP6	0																																									
		1																																									
7	HP7	0																																									
		1																																									
8	HP8	0																																									
		1																																									
9	HP9	0																																									
		1																																									
A	HP10	0																																									
		1																																									
B	SPACE0	0	<table border="1"> <thead> <tr> <th colspan="3">SPACE</th> <th rowspan="2">Number of Lines and Space &lt;(S) represents space&gt;</th> </tr> <tr> <th>2</th> <th>1</th> <th>0</th> </tr> </thead> <tbody> <tr> <td>0</td> <td>0</td> <td>0</td> <td>12</td> </tr> <tr> <td>0</td> <td>0</td> <td>1</td> <td>1 (S) 10 (S) 1</td> </tr> <tr> <td>0</td> <td>1</td> <td>0</td> <td>2 (S) 8 (S) 2</td> </tr> <tr> <td>0</td> <td>1</td> <td>1</td> <td>3 (S) 6 (S) 3</td> </tr> <tr> <td>1</td> <td>0</td> <td>0</td> <td>4 (S) 4 (S) 4</td> </tr> <tr> <td>1</td> <td>0</td> <td>1</td> <td>5 (S) 2 (S) 5</td> </tr> <tr> <td>1</td> <td>1</td> <td>0</td> <td>6 (S) 6</td> </tr> <tr> <td>1</td> <td>1</td> <td>1</td> <td>6 (S)(S) 6</td> </tr> </tbody> </table>	SPACE			Number of Lines and Space <(S) represents space>	2	1	0	0	0	0	12	0	0	1	1 (S) 10 (S) 1	0	1	0	2 (S) 8 (S) 2	0	1	1	3 (S) 6 (S) 3	1	0	0	4 (S) 4 (S) 4	1	0	1	5 (S) 2 (S) 5	1	1	0	6 (S) 6	1	1	1	6 (S)(S) 6	Leave one line worth of space in the vertical direction. For example, 6 (S) 6 indicates two sets of 6 lines with a line of spaces between lines 6 and 7. A line is 18 × N horizontal scan lines. N is determined by the character size in the vertical direction
		SPACE			Number of Lines and Space <(S) represents space>																																						
2	1	0																																									
0	0	0	12																																								
0	0	1	1 (S) 10 (S) 1																																								
0	1	0	2 (S) 8 (S) 2																																								
0	1	1	3 (S) 6 (S) 3																																								
1	0	0	4 (S) 4 (S) 4																																								
1	0	1	5 (S) 2 (S) 5																																								
1	1	0	6 (S) 6																																								
1	1	1	6 (S)(S) 6																																								
1																																											
C	SPACE1	0																																									
		1																																									
D	SPACE2	0																																									
		1																																									
E	RSEL1 (Note 3)	0	For setting, see REGISTER SUPPLYMENTARY DESCRIPTION (2).	Set display frequency range.																																							
		1																																									

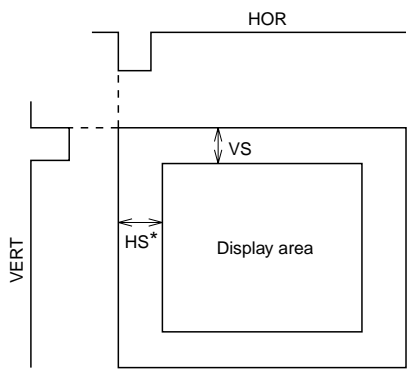

- Notes
1. The mark ○ around the status value means the reset status by the "L" level is input to AC pin.
  2. The page in which data is written is controlled by the DAF bit. When set to "0", data is written into page 0, whereas when set to "1", data is written into page 1.
  3. Registers marked with (Note 3) are found only in page 0, therefore the register value does not change when the DAF bit is set to "1".



SCREEN CHARACTER and PATTERN DISPLAY CONTROLLERS

(4) Address 123<sub>16</sub>

DA	Register	Contents		Remarks
		Status	Function	
0	VP0	0	If VS is the vertical display start location,	The vertical start location is specified using the 10 bits from VP9 to VP0. VP9 to VP0 = (0000000000 <sub>2</sub> ) setting is forbidden.
		1	$VS = H \times \sum_{n=0}^9 2^n VP_n$	
1	VP1	0	H: Cycle with the horizontal synchronizing pulse	
		1	1023 settings are possible.	
2	VP2	0		
		1		
3	VP3	0		
		1		
4	VP4	0		
		1		
5	VP5	0		
		1		
6	VP6	0		
		1		
7	VP7	0		
		1		
8	VP8	0		
		1		
9	VP9	0		
		1		
A	TEST0	0	It should be fixed to "0".	
		1	Can not be used.	
B	TEST1	0	It should be fixed to "0".	
		1	Can not be used.	
C	TEST2	0	It should be fixed to "0".	
		1	Can not be used.	
D	TEST3	0	It should be fixed to "0".	
		1	Can not be used.	
E	EXCK1 (Note 3)	0	For setting, see Register EXCK0 (address 120 <sub>16</sub> ).	Display clock setting
		1		

- Notes
- The mark ○ around the status value means the reset status by the "L" level is input to  $\overline{AC}$  pin.
  - The page in which data is written is controlled by the DAF bit. When set to "0", data is written into page 0, whereas when set to "1", data is written into page 1.
  - Registers marked with (Note 3) are found only in page 0, therefore the register value does not change when the DAF bit is set to "1".

SCREEN CHARACTER and PATTERN DISPLAY CONTROLLERS

(5) Address 124<sub>16</sub>

DA	Register	Contents		Remarks																				
		Status	Function																					
0	DSP0	0	The display mode (blanking mode) for line n on the display screen is set line-by-line, using DSPn (n = 0 to 11).	Sets the display mode of line 1.																				
		1																						
1	DSP1	0	The display mode is determined by the combination of registers BLK1 and BLK0 (address 128 <sub>16</sub> ). Settings are given below.	Sets the display mode of line 2.																				
		1																						
2	DSP2	0	<table border="1" style="display: inline-table; vertical-align: middle;"> <tr> <td>BLK1</td> <td>BLK0</td> <td>DSPn= "0"</td> <td>DSPn= "1"</td> </tr> <tr> <td>0</td> <td>0</td> <td>Matrix-outline border</td> <td>Matrix-outline</td> </tr> <tr> <td>0</td> <td>1</td> <td>Character</td> <td>Border</td> </tr> <tr> <td>1</td> <td>0</td> <td>Border</td> <td>Matrix-outline</td> </tr> <tr> <td>1</td> <td>1</td> <td>Matrix-outline</td> <td>Character</td> </tr> </table>	BLK1	BLK0	DSPn= "0"	DSPn= "1"	0	0	Matrix-outline border	Matrix-outline	0	1	Character	Border	1	0	Border	Matrix-outline	1	1	Matrix-outline	Character	Sets the display mode of line 3.
		BLK1		BLK0	DSPn= "0"	DSPn= "1"																		
0	0	Matrix-outline border	Matrix-outline																					
0	1	Character	Border																					
1	0	Border	Matrix-outline																					
1	1	Matrix-outline	Character																					
1																								
3	DSP3	0	(At register BCOL = "0")	Sets the display mode of line 4.																				
		1																						
4	DSP4	0	For detail, see DISPLAY FORM1(1).	Sets the display mode of line 5.																				
		1																						
5	DSP5	0		Sets the display mode of line 6.																				
		1																						
6	DSP6	0		Sets the display mode of line 7.																				
		1																						
7	DSP7	0		Sets the display mode of line 8.																				
		1																						
8	DSP8	0		Sets the display mode of line 9.																				
		1																						
9	DSP9	0		Sets the display mode of line 10.																				
		1																						
A	DSP10	0		Sets the display mode of line 11.																				
		1																						
B	DSP11	0		Sets the display mode of line 12.																				
		1																						
C	TEST4	0	It should be fixed to "0".																					
		1	Can not be used.																					
D	TEST5 (Note 3)	0	It should be fixed to "0".																					
		1	Can not be used.																					
E	TEST9 (Note 3)	0	Can not be used.																					
		1	It should be fixed to "1".																					

Notes 1. The mark ○ around the status value means the reset status by the "L" level is input to AC pin.

2. The page in which data is written is controlled by the DAF bit. When set to "0", data is written into page 0, whereas when set to "1", data is written into page 1.
3. Registers marked with (Note 3) are found only in page 0, therefore the register value does not change when the DAF bit is set to "1".

SCREEN CHARACTER and PATTERN DISPLAY CONTROLLERS

(6) Address 125<sub>16</sub>

DA	Register	Contents		Remarks															
		Status	Function																
0	LIN2	0	The vertical dot size for line n in the character dot lines (18 vertical lines) is set using LINn (n = 2 to 17).	Character size setting in the vertical direction for the 2nd line.															
		1																	
1	LIN3	0	Dot size can be selected between 2 types for each dot line.	Character size setting in the vertical direction for the 3rd line.															
		1																	
2	LIN4	0	For dot size, see the below registers. Line 1 and lines 2 to 12 can be set independent of one another.	Character size setting in the vertical direction for the 4th line.															
		1																	
3	LIN5	0	<table border="1" style="margin-left: auto; margin-right: auto;"> <thead> <tr> <th></th> <th>LINn = "0"</th> <th>LINn = "1"</th> </tr> </thead> <tbody> <tr> <td>1st line</td> <td>Refer to VSZ1L0 and VSZ1L1</td> <td>Refer to VSZ1H0 and VSZ1H1</td> </tr> <tr> <td>2nd to 12th line</td> <td>Refer to VSZ2L0 and VSZ2L1</td> <td>Refer to VSZ2H0 and VSZ2H1</td> </tr> </tbody> </table>		LINn = "0"	LINn = "1"	1st line	Refer to VSZ1L0 and VSZ1L1	Refer to VSZ1H0 and VSZ1H1	2nd to 12th line	Refer to VSZ2L0 and VSZ2L1	Refer to VSZ2H0 and VSZ2H1	Character size setting in the vertical direction for the 5th line.						
				LINn = "0"	LINn = "1"														
1st line	Refer to VSZ1L0 and VSZ1L1	Refer to VSZ1H0 and VSZ1H1																	
2nd to 12th line	Refer to VSZ2L0 and VSZ2L1	Refer to VSZ2H0 and VSZ2H1																	
1																			
4	LIN6	0		Character size setting in the vertical direction for the 6th line.															
		1																	
5	LIN7	0		Character size setting in the vertical direction for the 7th line.															
		1																	
6	LIN8	0		Character size setting in the vertical direction for the 8th line.															
		1																	
7	LIN9	0		Character size setting in the vertical direction for the 9th line.															
		1																	
8	V1SZ0	0	H: Cycle with the horizontal synchronizing pulse	Character size setting in the vertical direction for the 1st line. (display monitor 1 to 12 line)															
		1																	
9	V1SZ1	0	<table border="1" style="margin-left: auto; margin-right: auto;"> <thead> <tr> <th>V1SZ1</th> <th>V1SZ0</th> <th>Vertical direction size</th> </tr> </thead> <tbody> <tr> <td>0</td> <td>0</td> <td>1H/dot</td> </tr> <tr> <td>0</td> <td>1</td> <td>2H/dot</td> </tr> <tr> <td>1</td> <td>0</td> <td>3H/dot</td> </tr> <tr> <td>1</td> <td>1</td> <td>4H/dot</td> </tr> </tbody> </table>	V1SZ1	V1SZ0	Vertical direction size	0	0	1H/dot	0	1	2H/dot	1	0	3H/dot	1	1	4H/dot	
		V1SZ1		V1SZ0	Vertical direction size														
0	0	1H/dot																	
0	1	2H/dot																	
1	0	3H/dot																	
1	1	4H/dot																	
1																			
A	VSZ1L0	0	H: Cycle with the horizontal synchronizing pulse	Character size setting in the vertical direction (display monitor 1 line) at "0" state in register LIN2 to LIN17 (address 125 <sub>16</sub> , 126 <sub>16</sub> ).															
		1																	
B	VSZ1L1	0	<table border="1" style="margin-left: auto; margin-right: auto;"> <thead> <tr> <th>VSZ1L1</th> <th>VSZ1L0</th> <th>Vertical direction size</th> </tr> </thead> <tbody> <tr> <td>0</td> <td>0</td> <td>1H/dot</td> </tr> <tr> <td>0</td> <td>1</td> <td>2H/dot</td> </tr> <tr> <td>1</td> <td>0</td> <td>3H/dot</td> </tr> <tr> <td>1</td> <td>1</td> <td>4H/dot</td> </tr> </tbody> </table>	VSZ1L1	VSZ1L0	Vertical direction size	0	0	1H/dot	0	1	2H/dot	1	0	3H/dot	1	1	4H/dot	
		VSZ1L1		VSZ1L0	Vertical direction size														
0	0	1H/dot																	
0	1	2H/dot																	
1	0	3H/dot																	
1	1	4H/dot																	
1																			
C	VSZ1H0	0	H: Cycle with the horizontal synchronizing pulse	Character size setting in the vertical direction (display monitor 1 line) at "1" state in register LIN2 to LIN17 (address 125 <sub>16</sub> , 126 <sub>16</sub> ).															
		1																	
D	VSZ1H1	0	<table border="1" style="margin-left: auto; margin-right: auto;"> <thead> <tr> <th>VSZ1H1</th> <th>VSZ1H0</th> <th>Vertical direction size</th> </tr> </thead> <tbody> <tr> <td>0</td> <td>0</td> <td>1H/dot</td> </tr> <tr> <td>0</td> <td>1</td> <td>2H/dot</td> </tr> <tr> <td>1</td> <td>0</td> <td>3H/dot</td> </tr> <tr> <td>1</td> <td>1</td> <td>4H/dot</td> </tr> </tbody> </table>	VSZ1H1	VSZ1H0	Vertical direction size	0	0	1H/dot	0	1	2H/dot	1	0	3H/dot	1	1	4H/dot	
		VSZ1H1		VSZ1H0	Vertical direction size														
0	0	1H/dot																	
0	1	2H/dot																	
1	0	3H/dot																	
1	1	4H/dot																	
1																			
E	TEST10 (Note 3)	0	It should be fixed to "0".																
		1			Can not be used.														

Notes 1. The mark ○ around the status value means the reset status by the "L" level is input to AC pin.

2. The page in which data is written is controlled by the DAF bit. When set to "0", data is written into page 0, whereas when set to "1", data is written into page 1.
3. Registers marked with (Note 3) are found only in page 0, therefore the register value does not change when the DAF bit is set to "1".

SCREEN CHARACTER and PATTERN DISPLAY CONTROLLERS

(7) Address 126<sub>16</sub>

DA	Register	Contents		Remarks															
		Status	Function																
0	LIN10	0	The vertical dot size for line n in the character dot lines (18 vertical lines) is set using LINn (n = 2 to 17).	Character size setting in the vertical direction for the 10th line.															
		1																	
1	LIN11	0	Dot size can be selected between 2 types for each dot line.	Character size setting in the vertical direction for the 11th line.															
		1																	
2	LIN12	0	For dot size, see the below registers. Line 1 and lines 2 to 12 can be set independent of one another.	Character size setting in the vertical direction for the 12th line.															
		1																	
3	LIN13	0	<table border="1" style="margin-left: auto; margin-right: auto;"> <thead> <tr> <th></th> <th>LINn = "0"</th> <th>LINn = "1"</th> </tr> </thead> <tbody> <tr> <td>1st line</td> <td>Refer to VSZ1L0 and VSZ1L1</td> <td>Refer to VSZ1H0 and VSZ1H1</td> </tr> <tr> <td>2nd to 12th line</td> <td>Refer to VSZ2L0 and VSZ2L1</td> <td>Refer to VSZ2H0 and VSZ2H1</td> </tr> </tbody> </table>		LINn = "0"	LINn = "1"	1st line	Refer to VSZ1L0 and VSZ1L1	Refer to VSZ1H0 and VSZ1H1	2nd to 12th line	Refer to VSZ2L0 and VSZ2L1	Refer to VSZ2H0 and VSZ2H1	Character size setting in the vertical direction for the 13th line.						
				LINn = "0"	LINn = "1"														
1st line	Refer to VSZ1L0 and VSZ1L1	Refer to VSZ1H0 and VSZ1H1																	
2nd to 12th line	Refer to VSZ2L0 and VSZ2L1	Refer to VSZ2H0 and VSZ2H1																	
1																			
4	LIN14	0		Character size setting in the vertical direction for the 14th line.															
		1																	
5	LIN15	0		Character size setting in the vertical direction for the 15th line.															
		1																	
6	LIN16	0		Character size setting in the vertical direction for the 16th line.															
		1																	
7	LIN17	0		Character size setting in the vertical direction for the 17th line.															
		1																	
8	V18SZ0	0	H: Cycle with the horizontal synchronizing pulse	Character size setting in the vertical direction for the 18th line. (display monitor 1 to 12 line)															
		1																	
9	V18SZ1	0	<table border="1" style="margin-left: auto; margin-right: auto;"> <thead> <tr> <th>V18SZ1</th> <th>V18SZ0</th> <th>Vertical direction size</th> </tr> </thead> <tbody> <tr> <td>0</td> <td>0</td> <td>1H/dot</td> </tr> <tr> <td>0</td> <td>1</td> <td>2H/dot</td> </tr> <tr> <td>1</td> <td>0</td> <td>3H/dot</td> </tr> <tr> <td>1</td> <td>1</td> <td>4H/dot</td> </tr> </tbody> </table>	V18SZ1	V18SZ0	Vertical direction size	0	0	1H/dot	0	1	2H/dot	1	0	3H/dot	1	1	4H/dot	
		V18SZ1		V18SZ0	Vertical direction size														
0	0	1H/dot																	
0	1	2H/dot																	
1	0	3H/dot																	
1	1	4H/dot																	
1																			
A	VSZ2L0	0	H: Cycle with the horizontal synchronizing pulse	Character size setting in the vertical direction (display monitor for 2 to 12 line) at "0" state in register LIN2 to LIN17 (address 125 <sub>16</sub> , 126 <sub>16</sub> ).															
		1																	
B	VSZ2L1	0	<table border="1" style="margin-left: auto; margin-right: auto;"> <thead> <tr> <th>VSZ2L1</th> <th>VSZ2L0</th> <th>Vertical direction size</th> </tr> </thead> <tbody> <tr> <td>0</td> <td>0</td> <td>1H/dot</td> </tr> <tr> <td>0</td> <td>1</td> <td>2H/dot</td> </tr> <tr> <td>1</td> <td>0</td> <td>3H/dot</td> </tr> <tr> <td>1</td> <td>1</td> <td>4H/dot</td> </tr> </tbody> </table>	VSZ2L1	VSZ2L0	Vertical direction size	0	0	1H/dot	0	1	2H/dot	1	0	3H/dot	1	1	4H/dot	
		VSZ2L1		VSZ2L0	Vertical direction size														
0	0	1H/dot																	
0	1	2H/dot																	
1	0	3H/dot																	
1	1	4H/dot																	
1																			
C	VSZ2H0	0	H: Cycle with the horizontal synchronizing pulse	Character size setting in the vertical direction (display monitor for 2 to 12 line) at "0" state in register LIN2 to LIN17 (address 125 <sub>16</sub> , 126 <sub>16</sub> ).															
		1																	
D	VSZ2H1	0	<table border="1" style="margin-left: auto; margin-right: auto;"> <thead> <tr> <th>VSZ2H1</th> <th>VSZ2H0</th> <th>Vertical direction size</th> </tr> </thead> <tbody> <tr> <td>0</td> <td>0</td> <td>1H/dot</td> </tr> <tr> <td>0</td> <td>1</td> <td>2H/dot</td> </tr> <tr> <td>1</td> <td>0</td> <td>3H/dot</td> </tr> <tr> <td>1</td> <td>1</td> <td>4H/dot</td> </tr> </tbody> </table>	VSZ2H1	VSZ2H0	Vertical direction size	0	0	1H/dot	0	1	2H/dot	1	0	3H/dot	1	1	4H/dot	
		VSZ2H1		VSZ2H0	Vertical direction size														
0	0	1H/dot																	
0	1	2H/dot																	
1	0	3H/dot																	
1	1	4H/dot																	
1																			
E	POPOP (Note 3)	0	Page 1 priority display	Sets the priority page for when 2 pages are displayed at the same time. The setting is effective only when the standard display mode is set as MODE0 = "0", MODE1 = "0". See "DISPLAY FORM 2".															
		1	Page 0 priority display																

- Notes 1. The mark ○ around the status value means the reset status by the "L" level is input to AC pin.  
 2. The page in which data is written is controlled by the DAF bit. When set to "0", data is written into page 0, whereas when set to "1", data is written into page 1.  
 3. Registers marked with (Note 3) are found only in page 0, therefore the register value does not change when the DAF bit is set to "1".

SCREEN CHARACTER and PATTERN DISPLAY CONTROLLERS

(8) Address 127<sub>16</sub>

DA	Register	Contents				Remarks																																				
		Status	Function																																							
0	RR	0	<table border="1"> <thead> <tr> <th>RB</th> <th>RG</th> <th>RR</th> <th>Color</th> </tr> </thead> <tbody> <tr> <td>0</td> <td>0</td> <td>0</td> <td>Black</td> </tr> <tr> <td>0</td> <td>0</td> <td>1</td> <td>Red</td> </tr> <tr> <td>0</td> <td>1</td> <td>0</td> <td>Green</td> </tr> <tr> <td>0</td> <td>1</td> <td>1</td> <td>Yellow</td> </tr> <tr> <td>1</td> <td>0</td> <td>0</td> <td>Blue</td> </tr> <tr> <td>1</td> <td>0</td> <td>1</td> <td>Magenta</td> </tr> <tr> <td>1</td> <td>1</td> <td>0</td> <td>Cyan</td> </tr> <tr> <td>1</td> <td>1</td> <td>1</td> <td>White</td> </tr> </tbody> </table>			RB	RG	RR	Color	0	0	0	Black	0	0	1	Red	0	1	0	Green	0	1	1	Yellow	1	0	0	Blue	1	0	1	Magenta	1	1	0	Cyan	1	1	1	White	Sets the raster color of all blankings.
		RB	RG	RR	Color																																					
0	0	0	Black																																							
0	0	1	Red																																							
0	1	0	Green																																							
0	1	1	Yellow																																							
1	0	0	Blue																																							
1	0	1	Magenta																																							
1	1	0	Cyan																																							
1	1	1	White																																							
1																																										
1	RG	0																																								
		1																																								
2	RB	0																																								
		1																																								
3	FR	0	<table border="1"> <thead> <tr> <th>FB</th> <th>FG</th> <th>FR</th> <th>Color</th> </tr> </thead> <tbody> <tr> <td>0</td> <td>0</td> <td>0</td> <td>Black</td> </tr> <tr> <td>0</td> <td>0</td> <td>1</td> <td>Red</td> </tr> <tr> <td>0</td> <td>1</td> <td>0</td> <td>Green</td> </tr> <tr> <td>0</td> <td>1</td> <td>1</td> <td>Yellow</td> </tr> <tr> <td>1</td> <td>0</td> <td>0</td> <td>Blue</td> </tr> <tr> <td>1</td> <td>0</td> <td>1</td> <td>Magenta</td> </tr> <tr> <td>1</td> <td>1</td> <td>0</td> <td>Cyan</td> </tr> <tr> <td>1</td> <td>1</td> <td>1</td> <td>White</td> </tr> </tbody> </table>			FB	FG	FR	Color	0	0	0	Black	0	0	1	Red	0	1	0	Green	0	1	1	Yellow	1	0	0	Blue	1	0	1	Magenta	1	1	0	Cyan	1	1	1	White	Sets the blanking color of the Border size, or the shadow size.
		FB	FG	FR	Color																																					
0	0	0	Black																																							
0	0	1	Red																																							
0	1	0	Green																																							
0	1	1	Yellow																																							
1	0	0	Blue																																							
1	0	1	Magenta																																							
1	1	0	Cyan																																							
1	1	1	White																																							
1																																										
4	FG	0																																								
		1																																								
5	FB	0																																								
		1																																								
6	TEST6	0	It should be fixed to "0".																																							
		1	Can not be used.																																							
7	TEST7	0	It should be fixed to "0".																																							
		1	Can not be used.																																							
8	TEST8	0	It should be fixed to "0".																																							
		1	Can not be used.																																							
9	BETA14	0	Matrix-outline display (12 × 18 dot)																																							
		1	Matrix-outline display (14 × 18 dot)																																							
A	HSZ10	0	<table border="1"> <thead> <tr> <th>HSZ10</th> <th>Horizontal direction size</th> </tr> </thead> <tbody> <tr> <td>0</td> <td>1T/dot</td> </tr> <tr> <td>1</td> <td>2T/dot</td> </tr> </tbody> </table>			HSZ10	Horizontal direction size	0	1T/dot	1	2T/dot	Character size setting in the horizontal direction for the first line. T : Display frequency cycle																														
		HSZ10	Horizontal direction size																																							
0	1T/dot																																									
1	2T/dot																																									
1																																										
B	TEST11	0	It should be fixed to "0".																																							
		1	Can not be used.																																							
C	HSZ20	0	<table border="1"> <thead> <tr> <th>HSZ20</th> <th>Horizontal direction size</th> </tr> </thead> <tbody> <tr> <td>0</td> <td>1T/dot</td> </tr> <tr> <td>1</td> <td>2T/dot</td> </tr> </tbody> </table>			HSZ20	Horizontal direction size	0	1T/dot	1	2T/dot																															
		HSZ20	Horizontal direction size																																							
0	1T/dot																																									
1	2T/dot																																									
1																																										
D	TEST12	0	It should be fixed to "0".			Character size setting in the horizontal direction for the 2nd line to 12th line. T : Display frequency cycle																																				
		1	Can not be used.																																							
E	MODE0 (Note 3)	0	<table border="1"> <thead> <tr> <th>MODE1</th> <th>MODE0</th> <th>Display mode</th> </tr> </thead> <tbody> <tr> <td>0</td> <td>0</td> <td>Standard.(Note4)</td> </tr> <tr> <td>0</td> <td>1</td> <td>AND</td> </tr> <tr> <td>1</td> <td>0</td> <td>EXOR</td> </tr> <tr> <td>1</td> <td>1</td> <td>OR</td> </tr> </tbody> </table>			MODE1	MODE0	Display mode	0	0	Standard.(Note4)	0	1	AND	1	0	EXOR	1	1	OR	Sets the display mode for when 2 pages are displayed at the same time. See "DISPLAY FORM 2". MODE1(address128 <sub>16</sub> ) .																					
		MODE1	MODE0	Display mode																																						
0	0	Standard.(Note4)																																								
0	1	AND																																								
1	0	EXOR																																								
1	1	OR																																								
1																																										

Notes 1. The mark 0 around the status value means the reset status by the "L" level is input to AC pin.

2. The page in which data is written is controlled by the DAF bit. When set to "0", data is written into page 0, whereas when set to "1", data is written into page 1.

3. Registers marked with (Note 3) are found only in page 0, therefore the register value does not change when the DAF bit is set to "1".

4. 2 way settings are available by POPUP (address 126<sub>16</sub>).

SCREEN CHARACTER and PATTERN DISPLAY CONTROLLERS

(9) Address 128<sub>16</sub>

DA	Register	Contents		Remarks																	
		Status	Function																		
0	BCOL	0	Blanking of BLK0, BLK1	Sets all raster blanking																	
		1	All raster blanking																		
1	B/F (Note 3)	0	Synchronize with the leading edge of horizontal synchronization.	Synchronize with the front porch or back porch of the horizontal synchronazation signal.																	
		1	Synchronize with the trailing edge of horizontal synchronization.																		
2	VMASK (Note 3)	0	Do not mask by VERT input signal	Set mask at phase comparison operating.																	
		1	Mask by VERT input signal																		
3	POLV (Note 3)	0	VERT pin is negative polarity	Set VERT pin polarity.																	
		1	VERT pin is positive polarity																		
4	POLH (Note 3)	0	HOR pin is negative polarity	Set HOR pin polarity.																	
		1	HOR pin is positive polarity																		
5	BLK0	0	<table border="1"> <thead> <tr> <th>BLINK1</th> <th>BLINK0</th> <th>Blanking mode</th> </tr> </thead> <tbody> <tr> <td>0</td> <td>0</td> <td>Matrix-outline size</td> </tr> <tr> <td>0</td> <td>1</td> <td>Character size</td> </tr> <tr> <td>1</td> <td>0</td> <td>Border size</td> </tr> <tr> <td>1</td> <td>1</td> <td>Matrix-outline size</td> </tr> </tbody> </table>	BLINK1	BLINK0	Blanking mode	0	0	Matrix-outline size	0	1	Character size	1	0	Border size	1	1	Matrix-outline size	Set blanking mode. See "DISPLAY SHAPE 2".		
		BLINK1		BLINK0	Blanking mode																
0	0	Matrix-outline size																			
0	1	Character size																			
1	0	Border size																			
1	1	Matrix-outline size																			
1	(When DSPn (address 124 <sub>16</sub> ) = "0")																				
6	BLK1	0	Border display of character	See "DISPLAY FORM1 (2)".																	
		1			Shadow display of character																
8	RAMERS	0	RAM not erased	There is no need to reset because there is no register for this bit.																	
		1	RAM erased																		
9	STOP	0	Oscillation of clock for display	It is a test bit (TEST13) in the page 1 register, therefore fix it to "0".																	
		1	Stop the oscillation of clock for display																		
A	DSPON	0	Display OFF																		
		1	Display ON																		
B	BLINK0	0	<table border="1"> <thead> <tr> <th colspan="2">BLINK</th> <th>Duty</th> </tr> </thead> <tbody> <tr> <td>1</td> <td>0</td> <td rowspan="2">Blinking OFF</td> </tr> <tr> <td>0</td> <td>0</td> </tr> <tr> <td>0</td> <td>1</td> <td>25%</td> </tr> <tr> <td>1</td> <td>0</td> <td>50%</td> </tr> <tr> <td>1</td> <td>1</td> <td>75%</td> </tr> </tbody> </table>	BLINK		Duty	1	0	Blinking OFF	0	0	0	1	25%	1	0	50%	1	1	75%	Set blinking duty ratio.
		BLINK		Duty																	
1	0	Blinking OFF																			
0	0																				
0	1	25%																			
1	0	50%																			
1	1	75%																			
1																					
C	BLINK1	0	Divided into 64 of vertical synchronous signal	Set blinking frequency.																	
		1			Divided into 32 of vertical synchronous signal																
D	BLINK2	0	For setting, see MODE0 (address 127 <sub>16</sub> ).	Sets the display mode for when 2 pages are displayed at the same time.																	
		1																			
E	MODE1 (Note 3)	0																			
		1																			

Notes 1. The mark ○ around the status value means the reset status by the "L" level is input to AC pin.

2. The page in which data is written is controlled by the DAF bit. When set to "0", data is written into page 0, whereas when set to "1", data is written into page 1.
3. Registers marked with (Note 3) are found only in page 0, therefore the register value does not change when the DAF bit is set to "1".



**REGISTER SUPPLEMENTARY DESCRIPTION**

(1) Setting external clock input and display frequency mode

Setting external clock input and display frequency mode (by use of EXCK0 (120<sub>16</sub>), EXCK1 (123<sub>16</sub>) and DIV10 to DIV0 (120<sub>16</sub>), as explained here following.

(a) When (EXCK1, EXCK0) = (0, 0) .....External synchronous 1 (External clock display) ... Fosc = 20 to 70 MHz

Input from the TCK pin a constant-period continuous external clock that synchronizes with the horizontal synchronous signal. And input from HOR pin a constant period continuous horizontal synchronous signal.  
Never stop inputting the clock while displaying.  
Do not have to set a display frequency because the clock just as it is entered from outside is used as the display clock.

(b) When (EXCK1, EXCK0) = (0, 1) .....Internal synchronous... Fosc = 20 to 90 MHz

Clock input from the TCK pin is unnecessary. The multiply clock of the internally generated horizontal synchronous signal is used as the display clock.  
The display frequency is set by setting the multiply value of the horizontal synchronous frequency (of the display frequency) in DIV10 to DIV0 (address 120<sub>16</sub>). Also, set the display frequency range. (See the next page.)  
Display frequency is calculated using the below expression.

$$\text{Display frequency} = \text{Horizontal synchronous frequency} \times \text{Multiply value}$$

(c) When (EXCK1, EXCK0) = (1, 0) ..... Setting disabled

(d) When (EXCK1, EXCK0) = (1, 1) .....External synchronous 2 (Internal oscillation clock display) ... Fosc = 20 to 90 MHz

Input from the TCK pin a constant-period continuous external clock that synchronizes with the horizontal synchronous signal. And input from HOR pin a constant-period continuous horizontal synchronous signal.

Never stop inputting the clock while displaying.  
An internal clock which is in sync with the external input clock is used as the display clock.

Because the display frequency equals the external clock frequency, set N1 (division value) that satisfies the below expressions to DIV10 to DIV0 (address 120<sub>16</sub>) for make the display frequency is equal to the external clock frequency.

$$N1 = \text{external clock frequency} / \text{horizontal synchronous frequency}$$

$$N1 = \sum_{n=0}^{10} 2^n \text{DIV}_n$$

Also, set the display frequency range. (See the next page.)

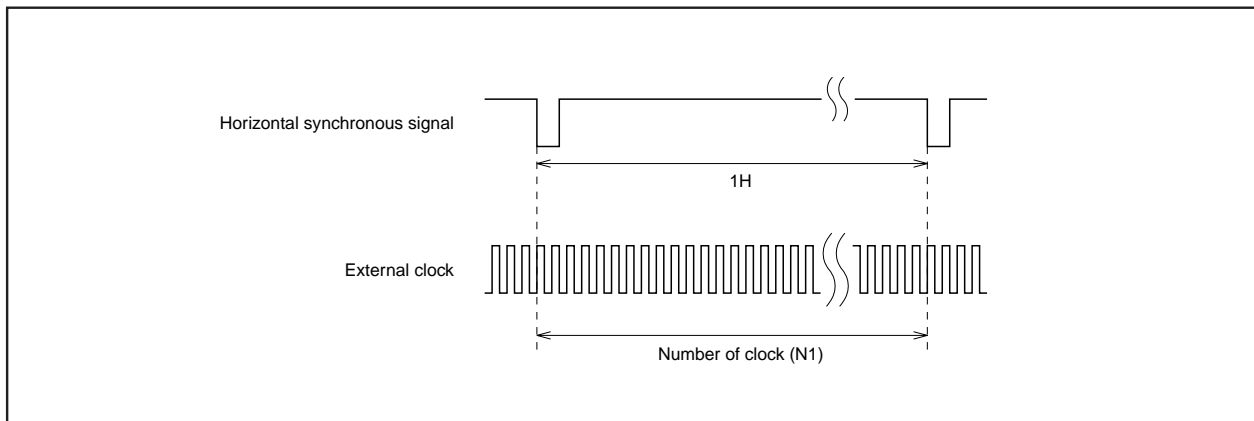

Fig. 4 Example of external clock input

(2) To set display frequency range

Whenever setting display frequency (when EXCK1 = "0", EXCK0 = "1", or EXCK1 = "1", EXCK0 = "1"), always set the display frequency range in accordance with the display frequency. This range is set from DIVS0, DIVS1 (address 120<sub>16</sub>), RSEL0 address 121<sub>16</sub>) and RSEL1 (address 122<sub>16</sub>). Frequency ranges are given here below.

RSEL1	RSEL0	DIVS1	DIVS0	Display frequency range (MHz)
1	1	0	0	87.0 to 90.0
1	0	0	0	67.0 to 87.0
0	1	0	0	54.0 to 67.0
1	0	0	1	47.0 to 54.0
0	0	0	0	40.0 to 47.0
1	0	1	0	34.0 to 40.0
0	0	0	1	30.0 to 34.0
0	1	1	0	26.0 to 30.0
1	0	1	1	23.0 to 26.0
0	0	1	0	20.0 to 23.0

(3) Notes on setting display frequency

To change external clock (display) frequency or horizontal synchronization frequency, always use the following procedures.

To set EXCK1 = "0", EXCK0 = "1"

- (a) Turn the display OFF. ... DSPON (address 128<sub>16</sub>) = "0"
- (b) Set the display frequency. ... Set from DIV10 to DIV0, DIVS0, DIVS1 (address 120<sub>16</sub>), RSEL0 (address 121<sub>16</sub>) and RSEL1 (address 122<sub>16</sub>).
- (c) Wait 20 ms while the horizontal synchronization signal is being input.
- (d) Turn the display ON. ... DSPON (address 128<sub>16</sub>) = "1"

To set EXCK1 = "1", EXCK0 = "1"

- (a) Turn the display OFF. ... DSPON (address 128<sub>16</sub>) = "0"
- (b) Set the display frequency. ... Set from DIV10 to DIV0, DIVS0, DIVS1 (address 120<sub>16</sub>), RSEL0 (address 121<sub>16</sub>) and RSEL1 (address 122<sub>16</sub>).
- (c) Wait 20 ms while the horizontal synchronization signal and external clock are being input.
- (d) Turn the display ON. ... DSPON (address 128<sub>16</sub>) = "1"

SCREEN CHARACTER and PATTERN DISPLAY CONTROLLERS

**DISPLAY FORM 1**

M35071-XXXSP/FP has the following four display forms.

(1) Blanking mode

Character size

: Blanking same as the character size.

Border size

: Blanking the background as a size from character.

Matrix-outline size

: Blanking the background 12 × 18 dot.

All blanking size

: When set register BCOL to "1", all raster area is blanking.

The display mode and blanking mode can be set line-by-line, as follows, from registers BCOL, BLK1, BLK0 (address 128<sub>16</sub>), DSP0 to DSP11 (address 124<sub>16</sub>).

BCOL	BLK1	BLK0	Line of DSPn = "0"		Line of DSPn = "1"	
			Display mode	Blanking mode	Display mode	Blanking mode
0	0	0	All matrix-outline border display	All matrix-outline size	All matrix-outline display	All matrix-outline size
	0	1	Character display	Character size	Border display	Border size
	1	0	Border display	Border size	All matrix-outline display	All matrix-outlinesize
	1	1	All matrix-outline display	All matrix-outline size	Character display	Character size
1	0	0	All matrix-outline border display	All blanking size	All matrix-outline display	All blanking size
	0	1	Character display		Border display	
	1	0	Border display		All matrix-outline display	
	1	1	All matrix-outline display		Character display	

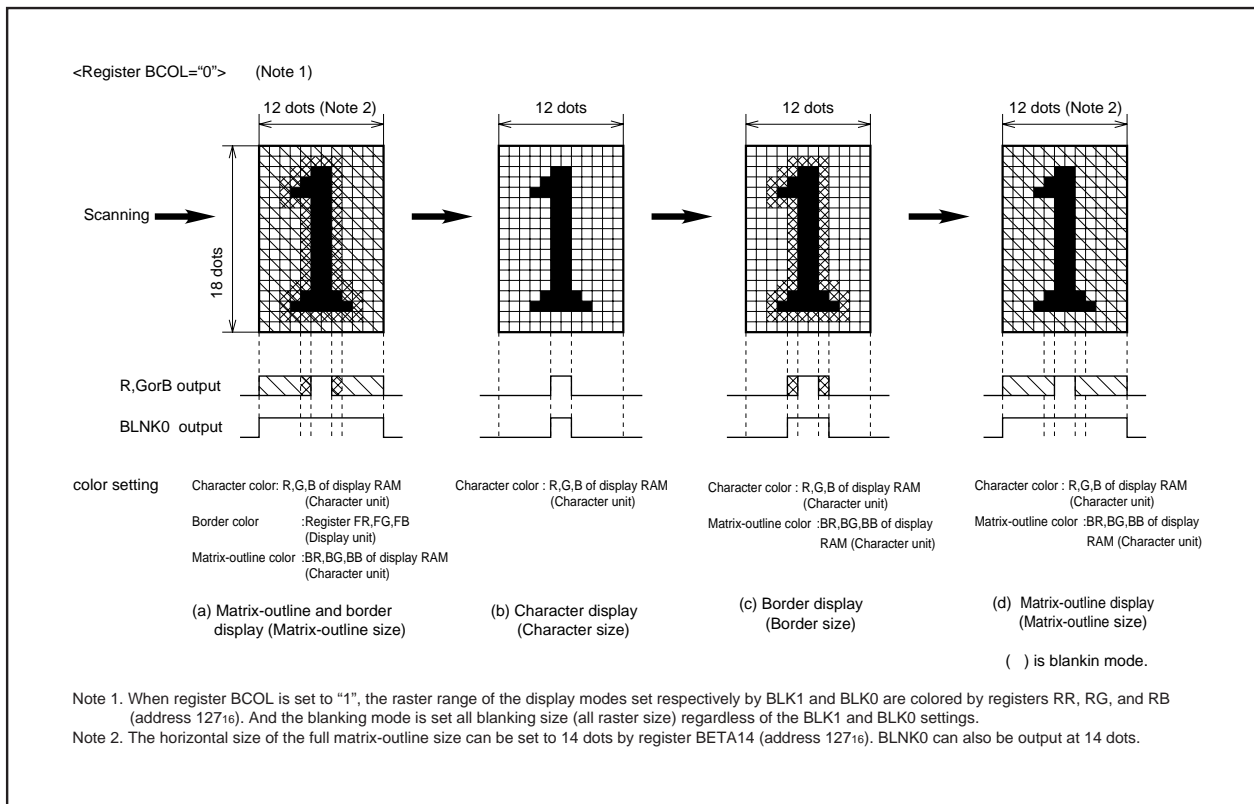

Fig. 5 Display form

## (2) Shadow display

When border display mode, if set SYAD (address 128<sub>16</sub>) = "0" to "1", it change to shadow display mode.

Border and shadow display are shown below.

Set shadow display color by BR, BG or BB of display RAM or by register FR, FG and FB (address 127<sub>16</sub>).

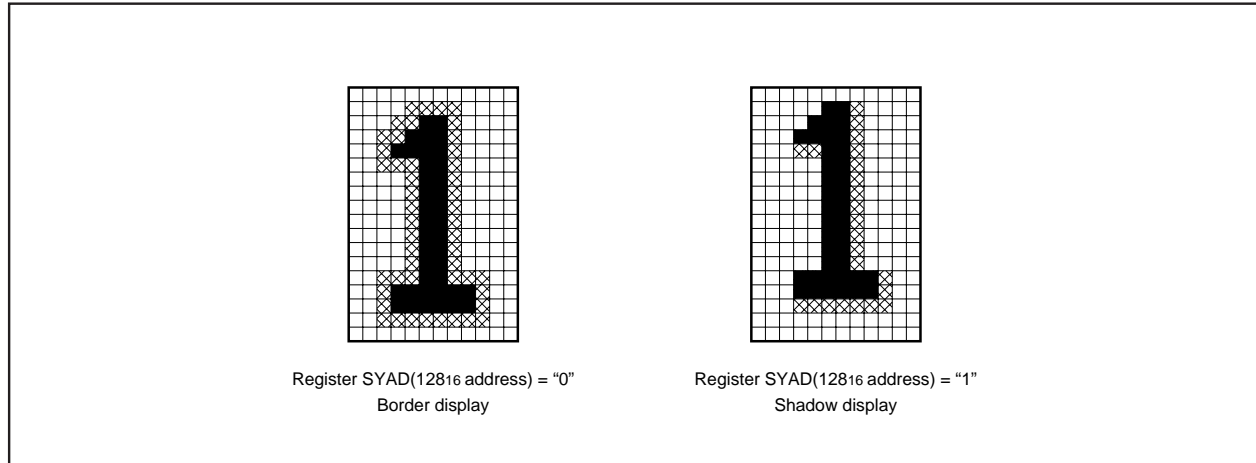

Fig. 6 Border and shadow display

## DISPLAY FORM 2

This IC can display both page 0 and page 1 at the same time.

Page 0: Set the DAF bit in each addresses to "0".

Page 1: Set the DAF bit in each addresses to "1".

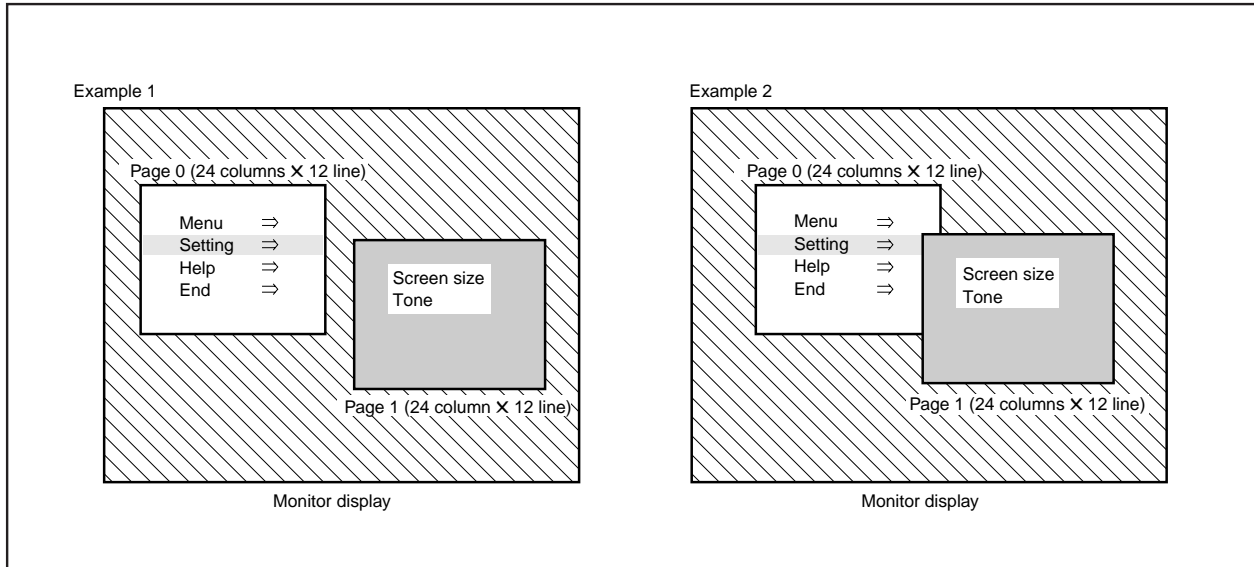

Fig. 7 Example of 2 pages display

Example 1: Display position, display size, color, etc., can be freely set for each page, and the 2 pages can be displayed on top of each other or side-by-side.

Example 2: When the display range of the 2 pages overlap on the monitor screen, they can be displayed in the 5 below ways using registers MODE0 (address 127<sub>16</sub>), MODE1 (address 128<sub>16</sub>) and POPUP (address 126<sub>16</sub>). (The POPUP register is effective only when MODE0 = "0" and MODE1 = "0".)

MODE1	MODE0	POPUP	Display mode
0	0	0	Standard (Page 1 priority)
		1	Standard (Page 0 priority)
0	1	—	AND
1	0	—	EXOR
1	1	—	OR

- (1) Standard (page 1 priority) ... Page 1 has priority in overlapping areas. Page 0 is not displayed in those areas.
- (2) Standard (page 0 priority) ... Page 0 has priority in overlapping areas. Page 1 is not displayed in those areas.
- (3) AND ..... In overlapping areas, the RGB output of the 2 pages is AND processed and output.
- (4) EXOR ..... In overlapping areas, the RGB output of the 2 pages is EXOR processed and output.
- (5) OR ..... In overlapping areas, the RGB output of the 2 pages is OR processed and output.

## CHARACTER FONT

Images are composed on a 12 × 18 dot matrix, and characters can be linked vertically and horizontally with other characters to allow the display the continuous symbols.

Character code FF<sub>16</sub> is fixed as a blank without background. Therefore, cannot register a character font in this code.

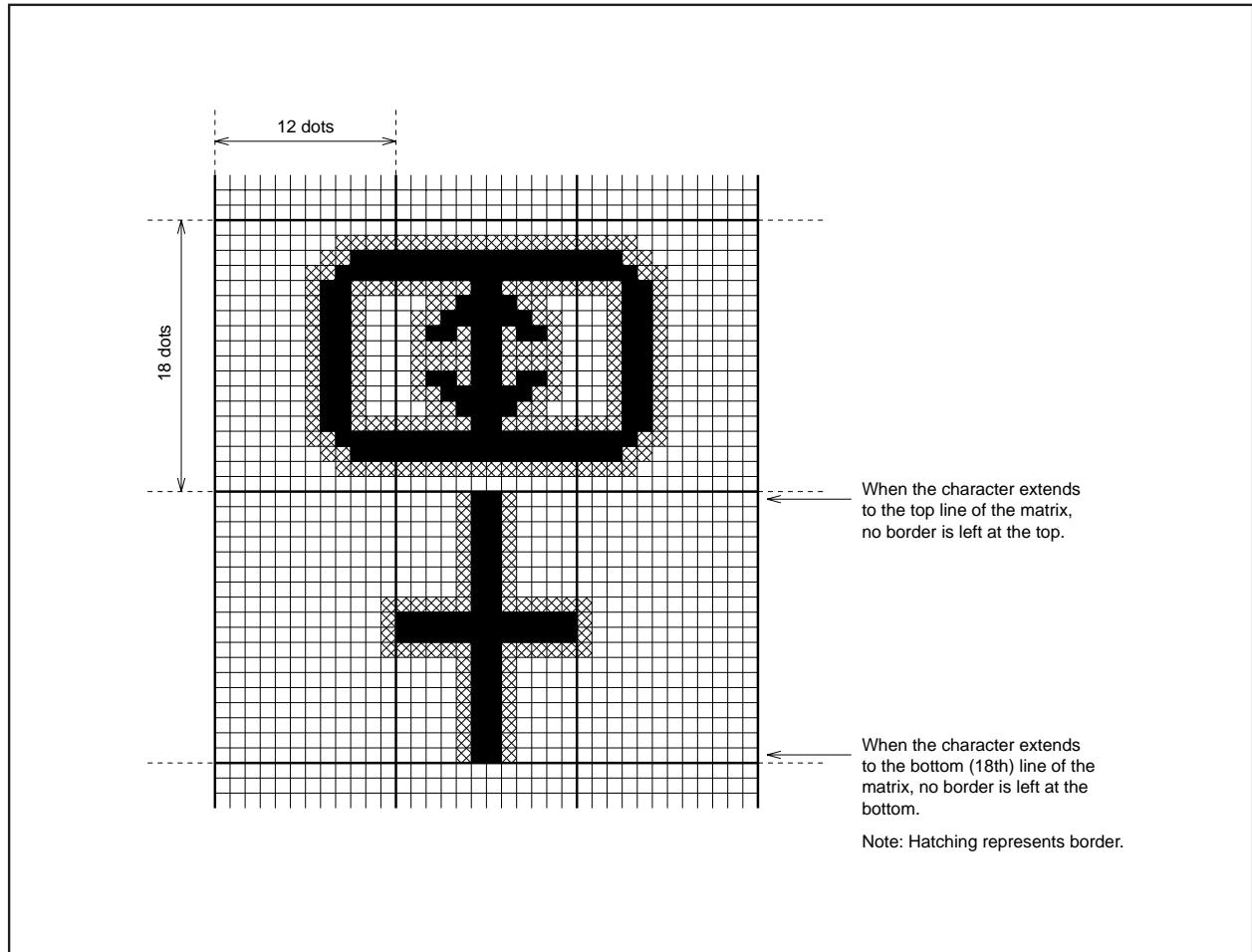

Fig. 8 Example of border display

**DATA INPUT EXAMPLE**

Data of display RAM and display control registers can be set by the I<sup>2</sup>C-BUS serial input function. Example of data setting is shown in Figure 9 (at EXCK0 = "1", EXCK1 = "0" setting).

Data input example (M35071-XXXSP/FP)																	
Address/data	DAF (Note1)	DAE	DAD	DAC	DAB	DAA	DA9	DA8	DA7	DA6	DA5	DA4	DA3	DA2	DA1	DA0	Remarks
200m sec hold																	
System set up (Note 4)																	
Address 120 <sub>16</sub>	0	0	0	0	0	0	0	1	0	0	1	0	0	0	0	0	Address setting
Data 120 <sub>16</sub>	0	1	0	DIVS1	DIVS0	DIV10	DIV9	DIV8	DIV7	DIV6	DIV5	DIV4	DIV3	DIV2	DIV1	DIV0	Frequency value setting (Note2)
Data 121 <sub>16</sub>	0	RSEL0	PTD7	PTD6	1	PTD4	1	PTD2	1	1	1	0	1	0	1	1	Output setting
Data 122 <sub>16</sub>	0	RSEL1	0	0	0	HP10	HP9	HP8	HP7	HP6	HP5	HP4	HP3	HP2	HP1	HP0	Horizontal display location setting
Data 123 <sub>16</sub>	0	0	0	0	0	VP9	VP8	VP7	VP6	VP5	VP4	VP3	VP2	VP1	VP0	Vertical display location setting	
Data 124 <sub>16</sub>	0	1	0	0	0	0	0	0	0	0	0	0	0	0	0	0	Display form setting
Data 125 <sub>16</sub>	0	0	0	0	0	0	0	0	0	0	0	0	0	0	0	0	Character size setting
Data 126 <sub>16</sub>	0	0	0	0	0	0	0	0	0	0	0	0	0	0	0	0	Character size setting
Data 127 <sub>16</sub>	0	0	0	0	0	0	0	0	0	0	0	0	0	0	0	0	Color, character size setting
Data 128 <sub>16</sub>	0	0	0	0	0	0	0	0	0	0	0	POLH	POLV	0	0	0	Page 0 display OFF
Address 122 <sub>16</sub>	0	0	0	0	0	0	0	1	0	0	1	0	0	0	1	0	Address setting
Data 122 <sub>16</sub>	1	0	0	0	0	HP10	HP9	HP8	HP7	HP6	HP5	HP4	HP3	HP2	HP1	HP0	Horizontal display location setting
Data 123 <sub>16</sub>	1	0	0	0	0	0	VP9	VP8	VP7	VP6	VP5	VP4	VP3	VP2	VP1	VP0	Vertical display location setting
Data 124 <sub>16</sub>	1	0	0	0	0	0	0	0	0	0	0	0	0	0	0	0	Display form setting
Data 125 <sub>16</sub>	1	0	0	0	0	0	0	0	0	0	0	0	0	0	0	0	Character size setting
Data 126 <sub>16</sub>	1	0	0	0	0	0	0	0	0	0	0	0	0	0	0	0	Character size setting
Data 127 <sub>16</sub>	1	0	0	0	0	0	0	0	0	0	0	0	0	0	0	0	Color, character size setting
Data 128 <sub>16</sub>	1	0	0	0	0	0	0	0	0	0	0	0	0	0	0	0	Page 1 display OFF
200m sec hold																	
Be stable / Waiting time																	
Data 000 <sub>16</sub>	0	BB	BG	BR	BLINK	B	G	R	C7	C6	C5	C4	C3	C2	C1	C0	Character setting
⋮	⋮	Background coloring			Blink-ing	Character color			Character code								
Data 11F <sub>16</sub>	0	BB	BG	BR	BLINK	B	G	R	C7	C6	C5	C4	C3	C2	C1	C0	
Address 000 <sub>16</sub>	0	0	0	0	0	0	0	0	0	0	0	0	0	0	0	0	Character setting
Data 000 <sub>16</sub>	1	BB	BG	BR	BLINK	B	G	R	0	C6	C5	C4	C3	C2	C1	C0	
⋮	⋮	Background coloring			Blink-ing	Character color			⋮	Character code							
Data 11F <sub>16</sub>	1	BB	BG	BR	BLINK	B	0	R	0	C6	C5	C4	C3	C2	C1	C0	
Address 128 <sub>16</sub>	0	0	0	0	0	0	0	1	0	0	1	0	1	0	0	0	Address setting
Data 128 <sub>16</sub>	1	0	0	0	0	1	0	0	0	1	1	0	0	0	0	0	Page 1 display ON Display form setting (Note 3)
Address 128 <sub>16</sub>	0	0	0	0	0	0	0	1	0	0	1	0	1	0	0	0	Address setting
Data 128 <sub>16</sub>	0	0	0	0	0	1	0	0	0	1	1	POLH	POLV	0	0	0	Page 0 display ON Display form setting (Note 3)

Notes 1 : The page in which data is written is controlled by the address. To write data into page 0, set "0". To write data into page 1, set "1".  
 2 : Input a continuous clock of constant period from the TCK pin. Also, input a horizontal synchronous signal into the HOR pin and a vertical synchronous signal into the VERT pin.  
 3 : Matrix-outline display in this data.  
 4 : Secure the waiting time of 200ms after releasing AC, and set data from setting the display frequency (setting of the register).

Fig 9. Example of data setting

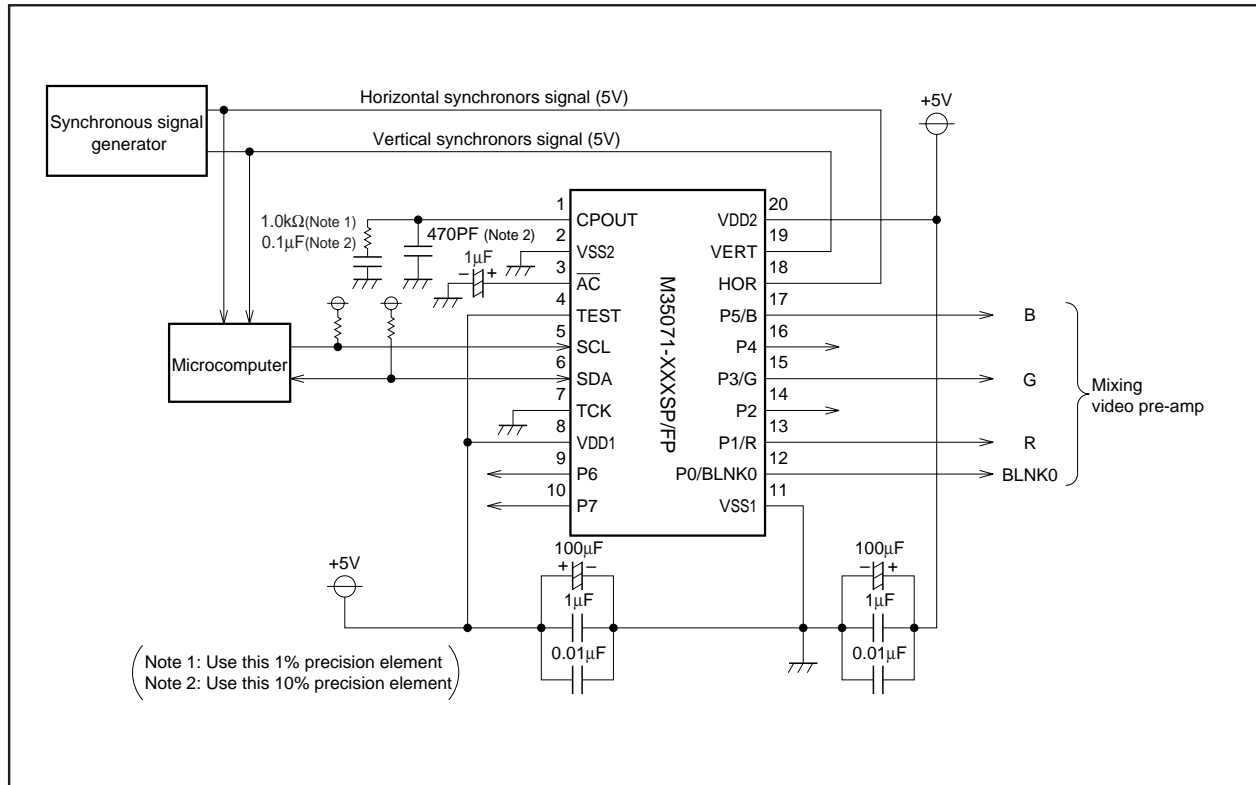
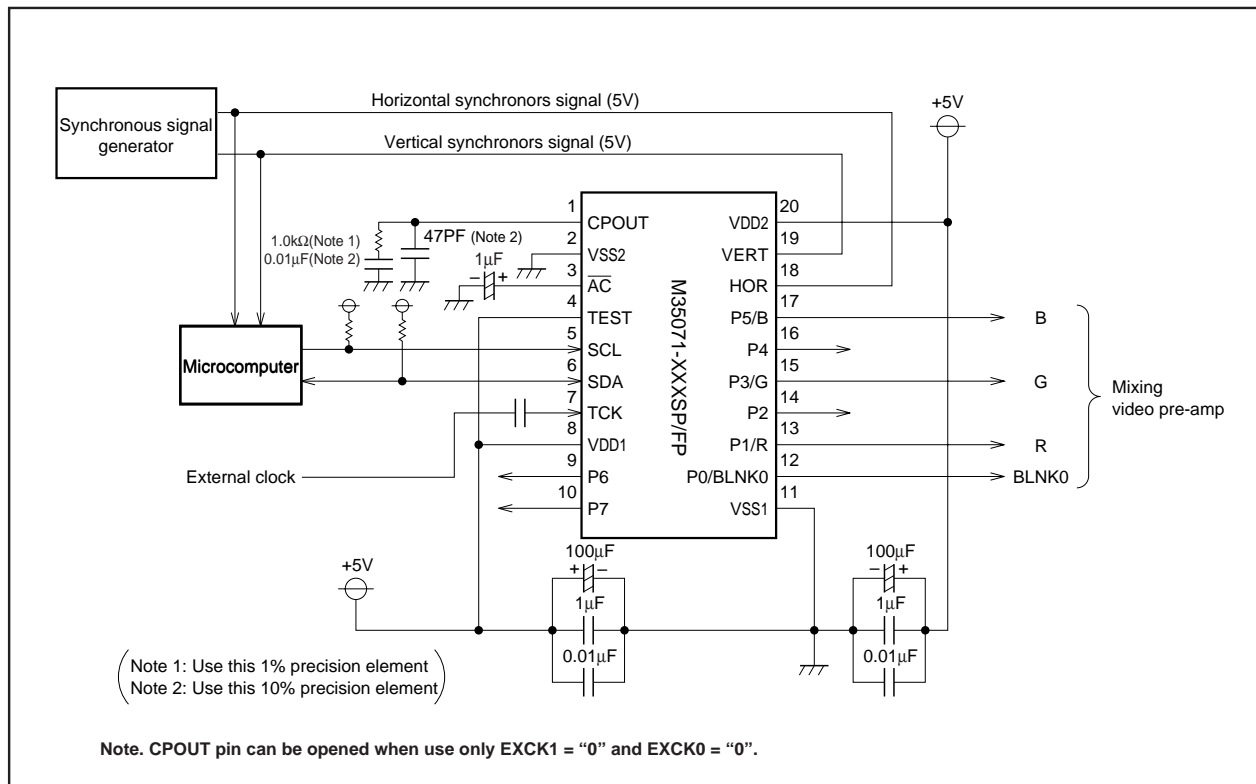

Fig. 10 Example of the M35071-XXXSP/FP peripheral circuit (Internal synchronous. At EXCK1 = "0", EXCK0 = "1")



Note. CPOUT pin can be opened when use only EXCK1 = "0" and EXCK0 = "0".

Fig. 11 Example of the M35071-XXXSP/FP peripheral circuit (External synchronous. At EXCK1 = "1", EXCK0 = "1")



**DATA INPUT**

(1) I<sup>2</sup>C-Bus communication function

This IC has a built-in data transmission interface which utilizes 2 unidirectional buses. In communications, this IC functions as a slave reception device.

The IC is synchronized with the serial clock (SCL) sent from the master device and receives the data (SDA). Communications are controlled from the start/stop states. Also, always input the control byte after attaining the start state.

The below chart shows the start/stop state and control byte configuration.

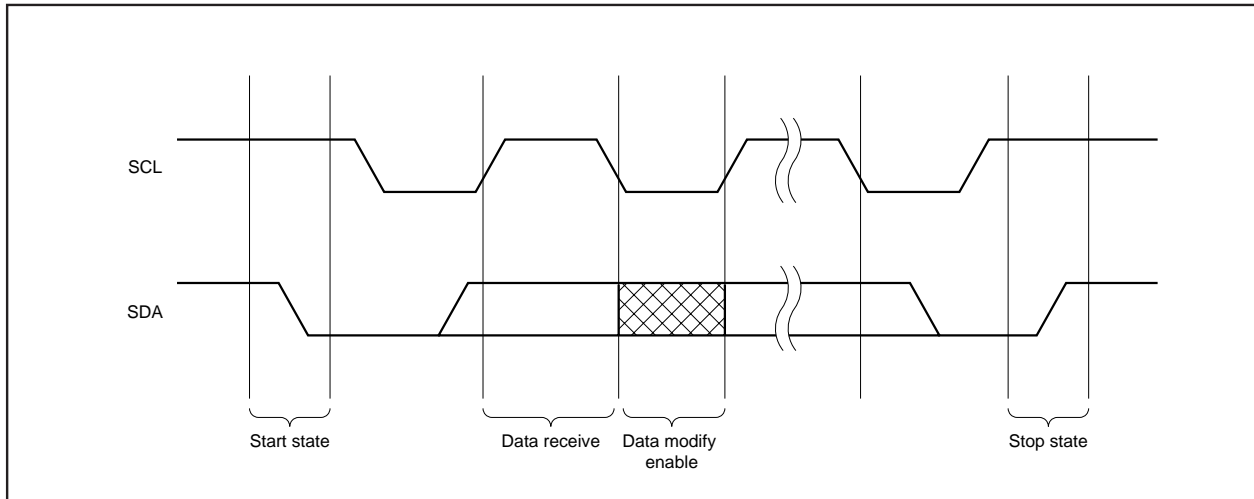

**Fig. 12 Start state / Stop state**

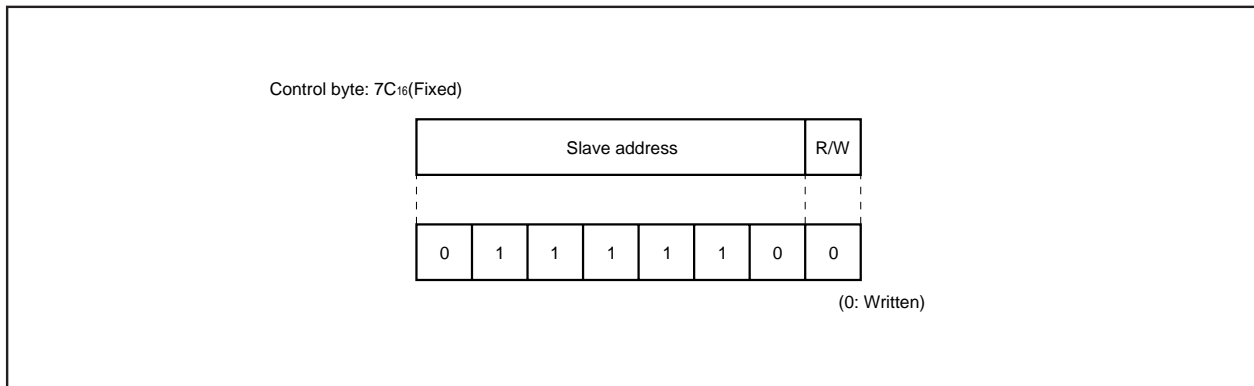

**Fig. 13 Control byte configuration**

## (2) Data input (Sequence)

- (a) Addresses are consists of 16 bits.
- (b) Data is consists of 16 bits.
- (c) Addresses and data are communicated in 8-bit units. Input the lower 8 bits before the upper 8 bits. Make input from the MSB side.
- (d) After the start state has been attained and the control byte (7CH) received, the next 16 bits (2 bytes) are for inputting the address. Addresses are increased in increments for every 16 bits (2 bytes) of data input thereafter. As a result, it is not necessary to input the address from the second data.

Note: During external synchronous, stop the external clock input from the TCK pin while inputting data.

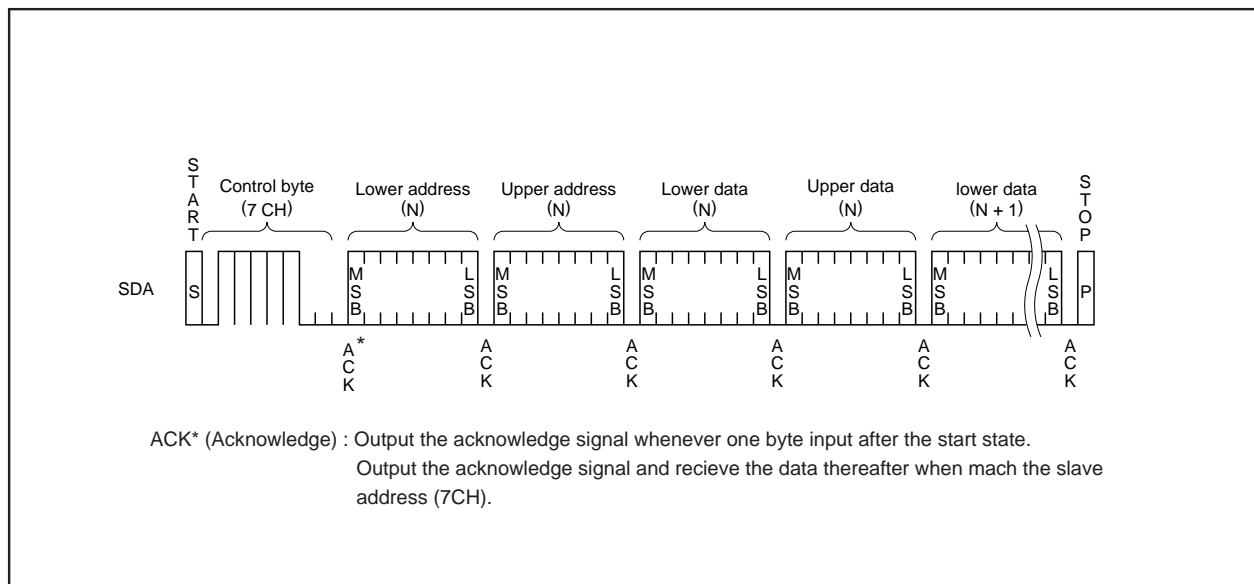

Fig. 14 Data input sequence

**TIMING REQUIREMENTS**

Data input

Symbol	Parameter	Limits				Unit	Remarks
		Typ. mode		High-speed mode			
		Min.	Max.	Min.	Max.		
fCLK	Clock frequency	0	100	0	400	KHz	
tHIGH	HIGH period of Clock	4000	-	600	-	ns	
tLOW	LOW period of Clock	4700	-	1300	-	ns	
tR	SDA & SCL rise time	-	1000	20+(Note) 0.1Cb	300	ns	
tF	SDA & SCL fall time	-	300	20+(Note) 0.1Cb	300	ns	
tHD : STA	Hold time at START status	4000	-	600	-	ns	
tsu : STA	Set up time at START status	4700	-	600	-	ns	Only at START state repeating generation
tHD : DAT	Data input hold time	0	-	0	-	ns	
tsu : DAT	Data input setup time	250	-	100	-	ns	
tsu : STO	Set up time at STOP state	4000	-	600	-	ns	
tBUF	Bus release time	4700	-	1300	-	ns	Time must be released bus before next transmission
tSP	Input filter / spike suppress (SDA & SCL pin)	N/A	N/A	0	50	ns	

Note. Cb = total capacitance of 1 bus line.

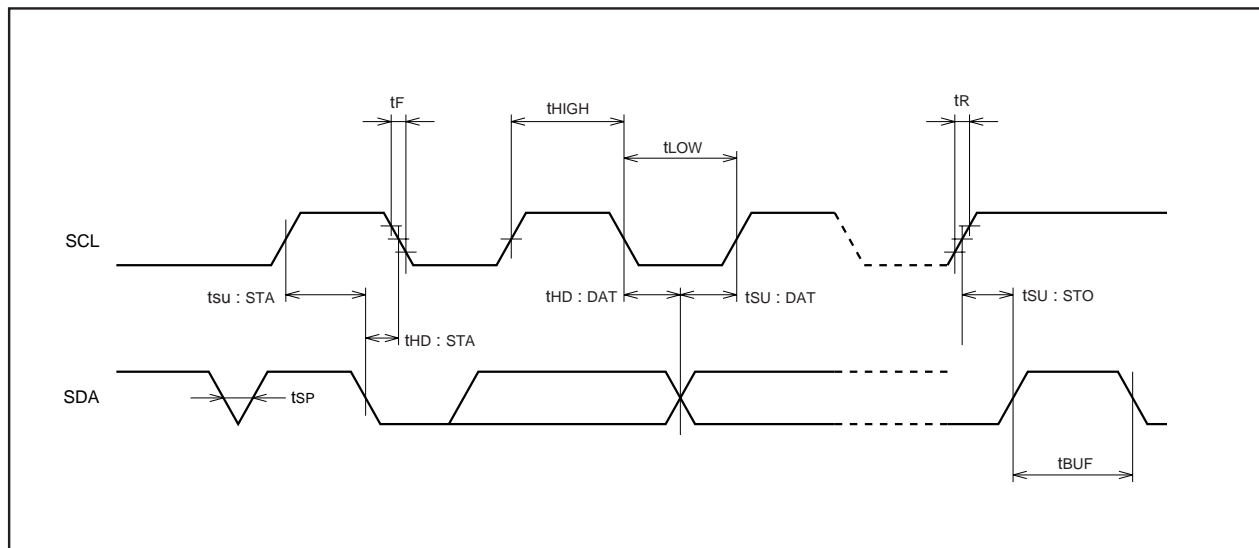

Fig. 15 Data input timing

SCREEN CHARACTER and PATTERN DISPLAY CONTROLLERS

**ABSOLUTE MAXIMUM RATINGS** ( $V_{DD} = 5.00V$ ,  $T_a = -20$  to  $+85^\circ C$ , unless otherwise noted)

Symbol	Parameter	Conditions	Ratings	Unit
$V_{DD}$	Supply voltage	With respect to $V_{SS}$ .	-0.3 to +6.0	V
$V_I$	Input voltage		$V_{SS} - 0.3 \leq V_I \leq V_{DD} + 0.3$	V
$V_O$	Output voltage		$V_{SS} \leq V_O \leq V_{DD}$	V
$P_d$	Power dissipation	$T_a = +25^\circ C$	+300	mW
$T_{opr}$	Operating temperature		-20 to +85	$^\circ C$
$T_{stg}$	Storage temperature		-40 to +125	$^\circ C$

**RECOMMENDED OPERATING CONDITIONS** ( $V_{DD} = 5.00V$ ,  $T_a = -20$  to  $+85^\circ C$ , unless otherwise noted)

Symbol	Parameter		Limits			Unit
			Min.	Typ.	Max.	
$V_{DD}$	Supply voltage		4.75	5.0	5.25	V
$V_{IH}$	"H" level input voltage	$\overline{AC}$ HOR, VERT	$0.8V_{DD}$	$V_{DD}$	$V_{DD}$	V
		SCL, SDA	$0.7V_{DD}$	$V_{DD}$	$V_{DD}$	V
$V_{IL}$	"L" level input voltage	$\overline{AC}$ HOR, VERT	0	0	$0.2V_{DD}$	V
		SCL, SDA	0	0	$0.3V_{DD}$	V
$F_{OSC}$	Oscillating frequency for display		20.0	—	90.0	MHz
H.sync	Horizontal synchronous signal input frequency		15.0	—	130.0	kHz

**ELECTRICAL CHARACTERISTICS** ( $V_{DD} = 5.00V$ ,  $T_a = 25^\circ C$ , unless otherwise noted)

Symbol	Parameter		Test conditions	Limits			Unit
				Min.	Typ.	Max.	
$V_{DD}$	Supply voltage		$T_a = -20$ to $+85^\circ C$	4.75	5.0	5.25	V
$I_{DD}$	Supply current		$V_{DD} = 5.00V$	—	40	60	mA
$V_{OH}$	"H" level output voltage	P0 to P7 (Note1)	$V_{DD} = 4.75V$ , $I_{OH} = -0.4mA$	3.5	—	—	V
		CPOUT	$V_{DD} = 4.75V$ , $I_{OH} = -0.05mA$				
$V_{OL}$	"L" level output voltage	P0 to P7 (Note2)	$V_{DD} = 4.75V$ , $I_{OL} = 0.4mA$	—	—	0.4	V
		CPOUT	$V_{DD} = 4.75V$ , $I_{OL} = 0.05mA$				
		SDA	$V_{DD} = 4.75V$ , $I_{OL} = 3.0mA$				
$R_I$	Pull-up resistance $\overline{AC}$		$V_{DD} = 5.00V$	10	30	100	$k\Omega$
$V_{TCK}$	External clock input width		$4.75V \leq V_{DD} \leq 5.25V$	$0.6V_{DD}$	—	$0.9V_{DD}$	V

Notes 1. The current from the IC must not exceed -0.4 mA/port at any of the port pins (P0 to P7).

2. The current flowing into the IC must not exceed 0.4 mA/port at any of port pins (P0 to P7).

**NOTE FOR SUPPLYING POWER**

(1)Timing of power supplying to  $\overline{AC}$  pin

The internal circuit of M35071-XXXSP/FP is reset when the level of the auto clear input pin  $\overline{AC}$  is "L". This pin in hysteresis input with the pull-up resistor.

The timing about power supplying of  $\overline{AC}$  pin is shown in Figure 16.

After supplying the power ( $V_{DD}$  and  $V_{SS}$ ) to M35071-XXXSP/FP and the supply voltage becomes more than  $0.8 \times V_{DD}$ , it needs to keep  $V_{IL}$  time;  $t_w$  of the  $\overline{AC}$  pin for more than 1ms.

Start inputting from microcomputer after  $\overline{AC}$  pin supply voltage becomes more than  $0.8 \times V_{DD}$  and keeping 200ms wait time.

(2)Timing of power supplying to  $V_{DD1}$  and  $V_{DD2}$ .

Supply power to  $V_{DD1}$  and  $V_{DD2}$  at the same time.

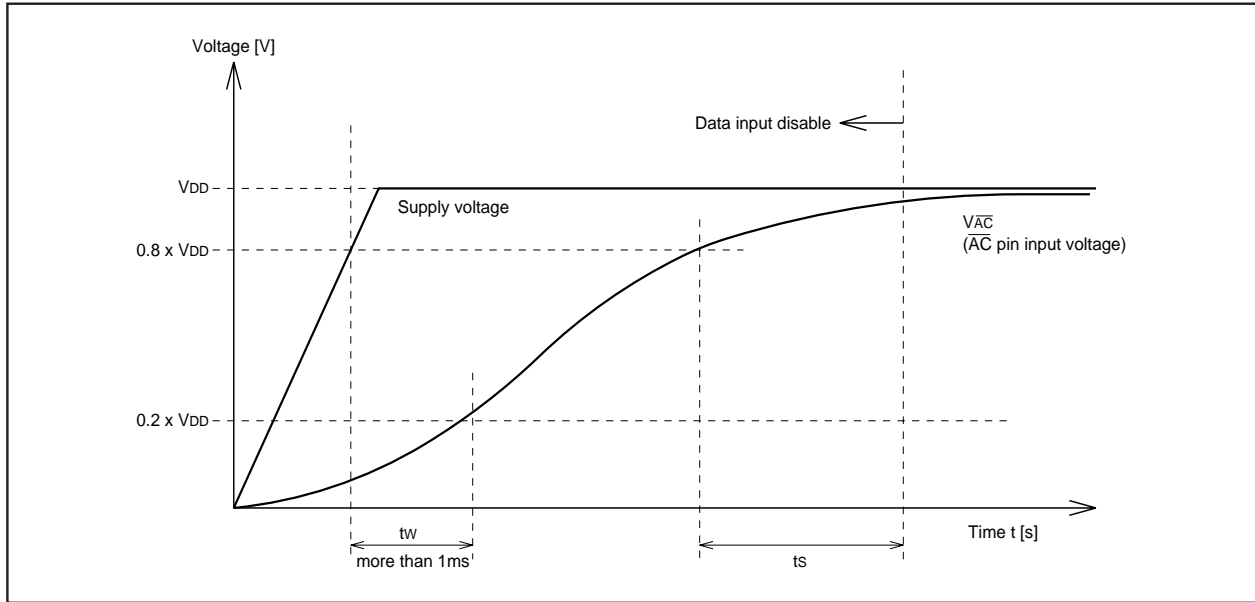

Fig. 16 Timing of power supplying to  $\overline{AC}$  pin

**PRECAUTION FOR USE**

Notes on noise and latch-up

In order to avoid noise and latch-up, connect a bypass capacitor ( $\approx 0.1\mu F$ ) directly between the  $V_{DD1}$  pin and  $V_{SS1}$  pin, and the  $V_{DD2}$  pin and  $V_{SS2}$  pin using a heavy wire.

Note for waveform timing of the horizontal signals to the HOR pin

Set horizontal synchronous signal edge\* waveform timing to under 5ns and input to HOR pin.

Set only the side which set by  $B/\overline{F}$  register waveform timing under 5ns and input to HOR pin.

\*: Set front porch edge or back porch edge by  $B/\overline{F}$  register.

**DATA REQUIRED FOR MASK ROM ORDERING**

Please send the following data for mask orders.

- (1) M35071-XXXSP/FP mask ROM order confirmation form
- (2) 20P4B mask specification form
- (3) 20P2Q-A mask specification form
- (4) ROM data (EPROM 3 sets)
- (5) Floppy disks containing the character font generating program + character data

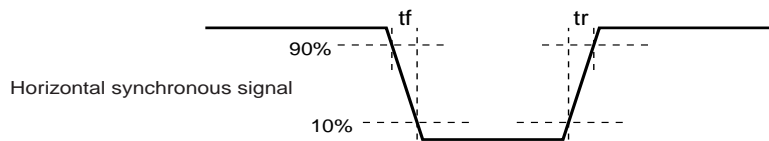

**STANDARD ROM TYPE : M35071-002SP/FP**

M35071-002SP/FP is a standard ROM type of M35071-XXXSP/FP.  
The character patterns for 0 page are fixed to the contents of Figure 17 to 20, the character patterns for page 1 are fixed to the contents of Figure 21 and 22.

SCREEN CHARACTER and PATTERN DISPLAY CONTROLLERS

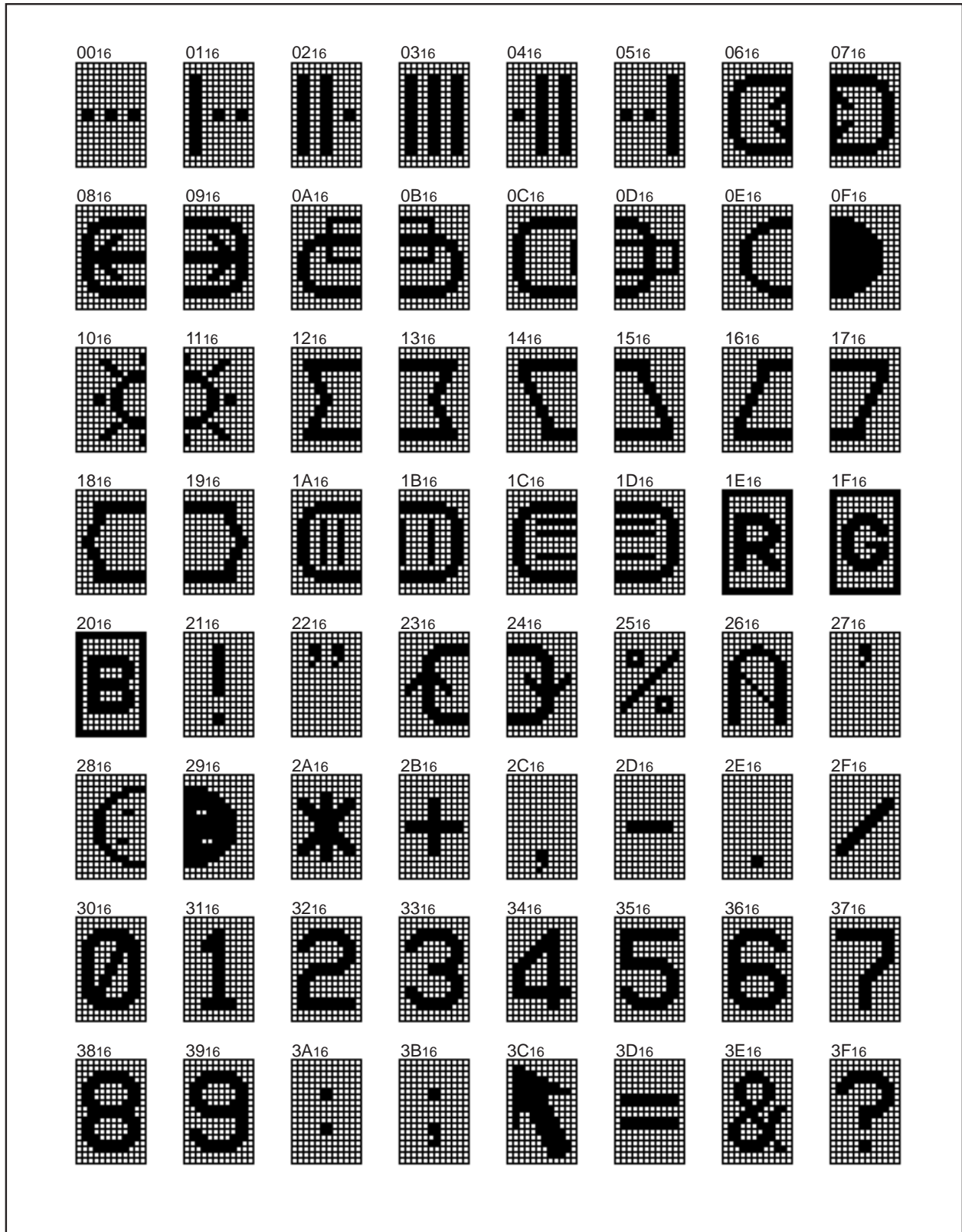

Fig. 17 M35071-002SP/FP character pattern for page 0 (1)

SCREEN CHARACTER and PATTERN DISPLAY CONTROLLERS

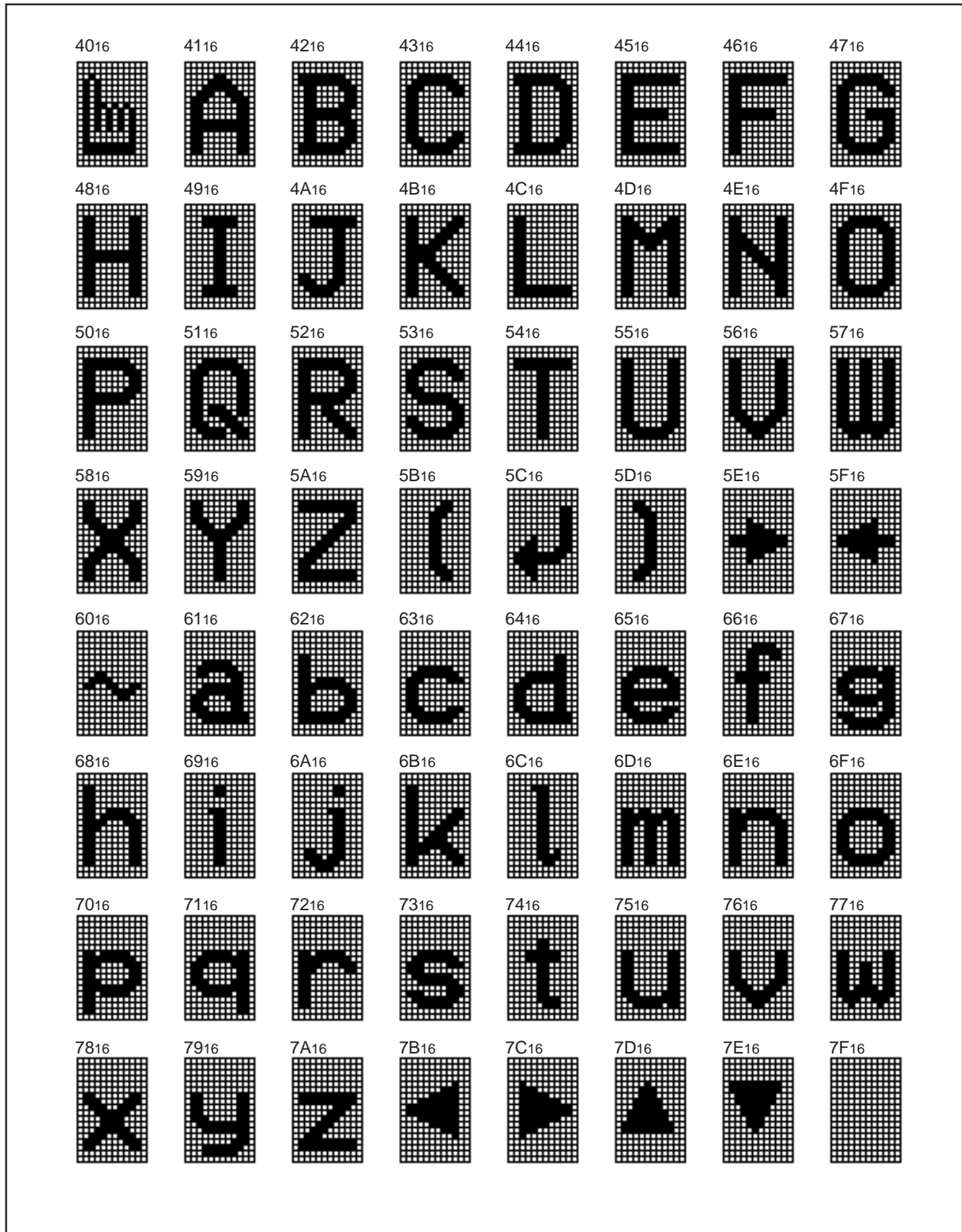

Fig. 18 M35071-002SP/FP character pattern for page 0 (2)



SCREEN CHARACTER and PATTERN DISPLAY CONTROLLERS

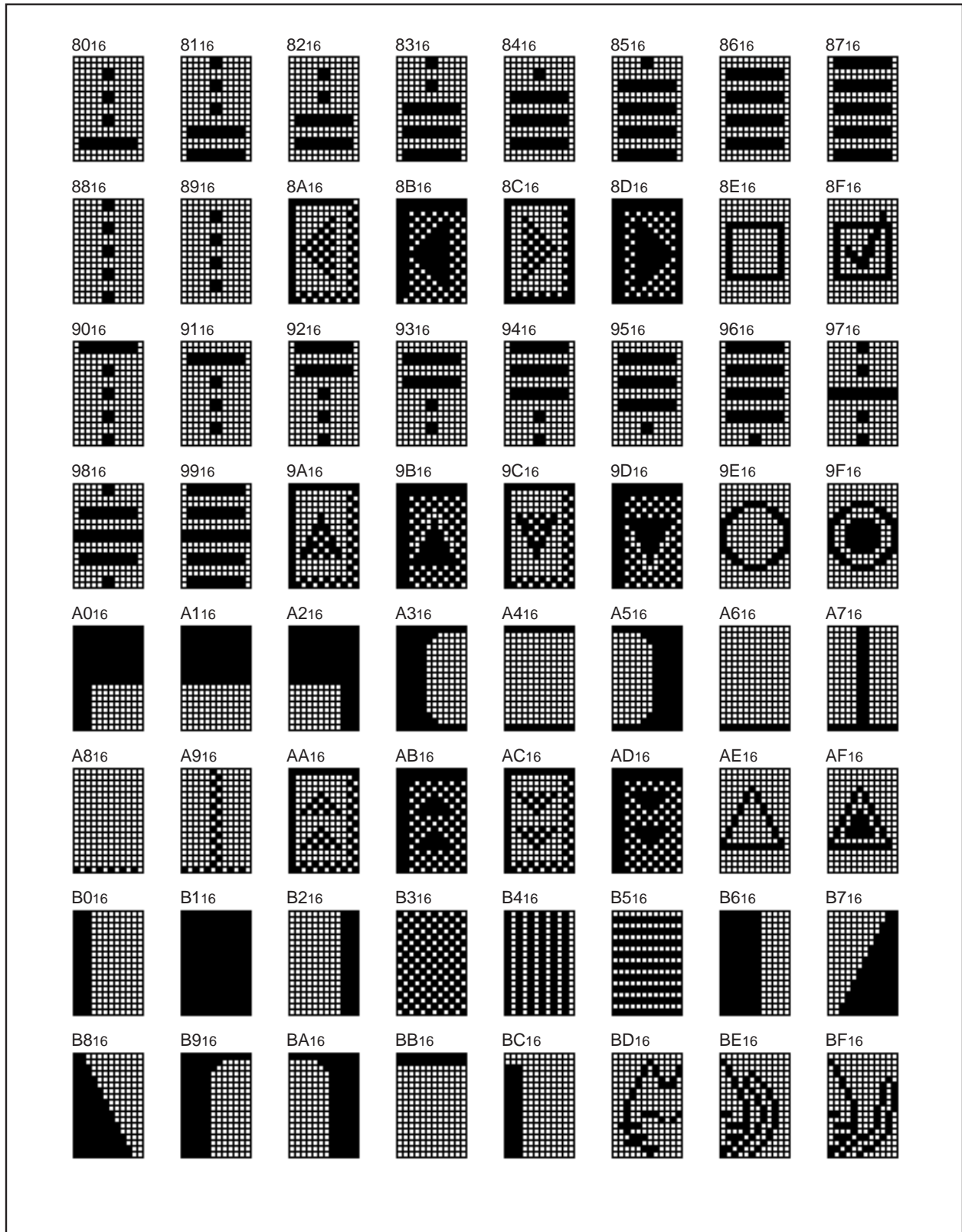

Fig. 19 M35071-002SP/FP character pattern for page 0 (3)

SCREEN CHARACTER and PATTERN DISPLAY CONTROLLERS



Fig. 20 M35071-002SP/FP character pattern for page 0 (4)

SCREEN CHARACTER and PATTERN DISPLAY CONTROLLERS

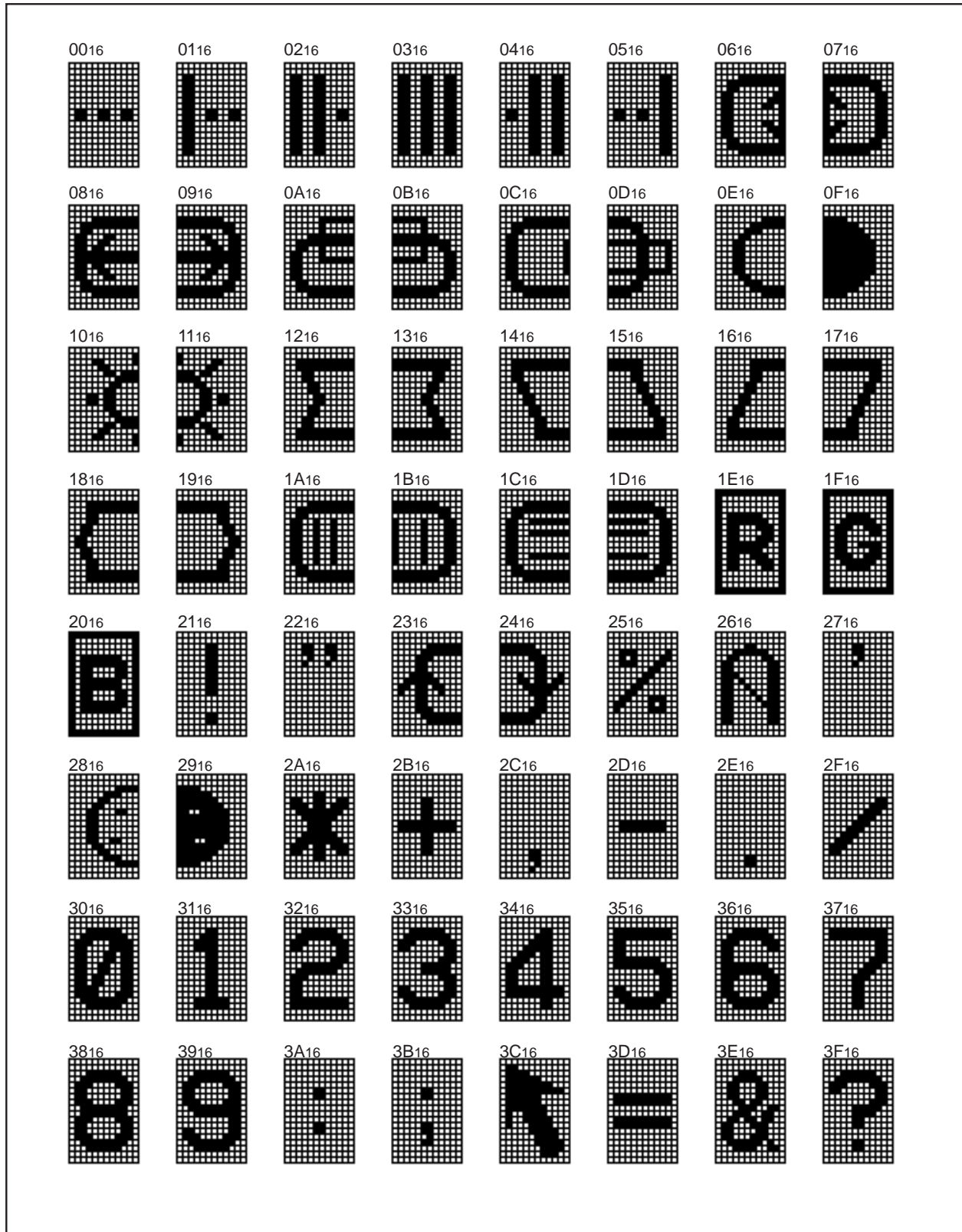

Fig. 21 M35071-002SP/FP character pattern for page 1 (1)

SCREEN CHARACTER and PATTERN DISPLAY CONTROLLERS

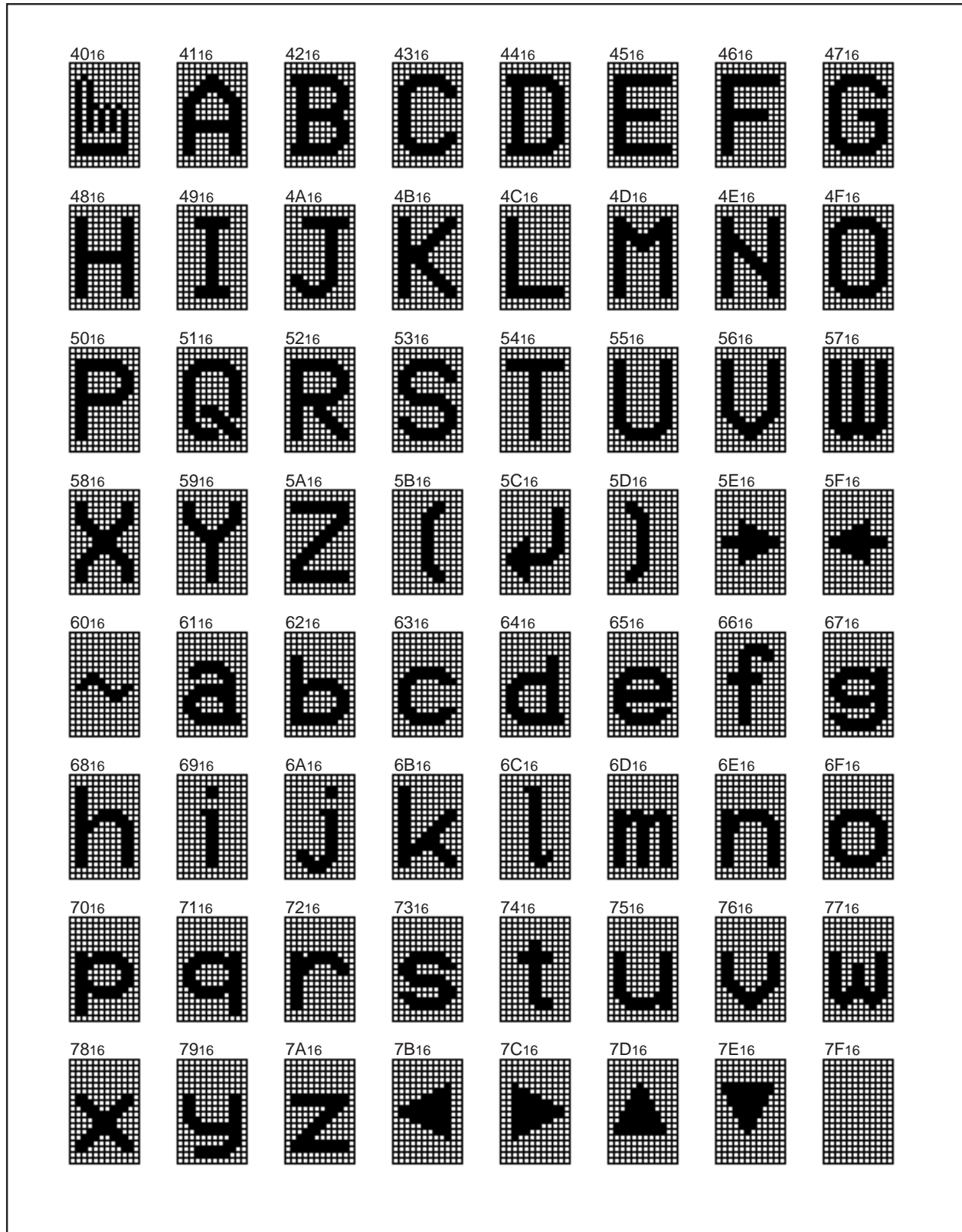

Fig. 22 M35071-002SP/FP character pattern for page 1 (2)

**MASK ROM ORDER CONFIRMATION FORM**

GZZ-SH00-71B<77A0>

Mask ROM number	
-----------------	--

**MASK ROM ORDER CONFIRMATION FORM  
SCREEN DISPLAY IC M35071-XXXSP/FP  
MITSUBISHI ELECTRIC**

Receipt	Data :	
	Section head signature	Supervisor signature

Note : Please fill in all items marked \*, .

* Customer	Company name	TEL ( )	Issuance signature	Approval	Verification	Framing
	Data issued	Date :				

* Program version name	M071R .V
------------------------	----------

\*Remarks

- Return the Character Font Preparation Program after use.
- Three EPROMs are required. Specify the type of EPROMs submitted. (All the three EPROMs must be same types. Check in the appropriate box.)

27512

(1) The font data prepared by the Character Font Preparation Program is saved as a binary type object file (addresses 0000h to FFFFh) and a hex type object file . Three sets of these EPROMs are required.

(2) Attach the erase protect seals on three EPROMs. Each seal bears the type name (M35071), and ROM No. (-...SP/FP).

- Write the checksum code (hexadecimal notation) for entire EPROM areas.

Checksum 

--	--	--	--

- Select the marking type (Check  in the appropriate box).

Special Mark .....Fill in the Mark Specification Form (20P4B for M35071-XXXSP, 20P2Q-A for M35071-XXXFP) and attach to the Mask ROM Order Confirmation Form.

Standard Mark .....No writing is required.

- Select the package type (Check  in the appropriate box).

..... SDIP type (M35071-XXXSP)

..... SSOP type (M35071-XXXFP)

\*● Comments

GZZ-SH00-71B<77A0>

Mask ROM number	
-----------------	--

1.(Page 0) Test patterns

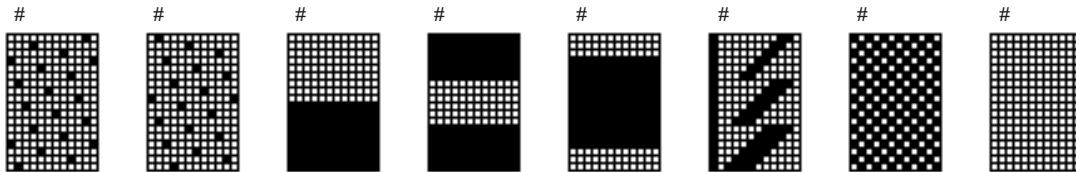

2.(Page 0) Character patterns  
(See the next page)

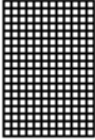
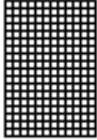
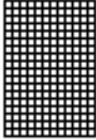
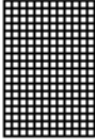
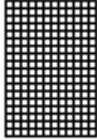
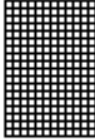
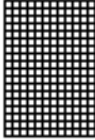
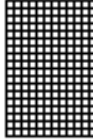
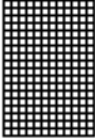
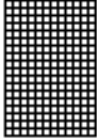
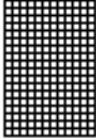
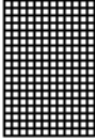
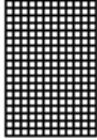
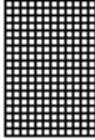
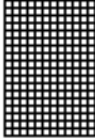
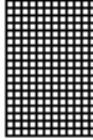
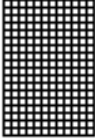
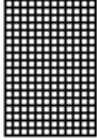
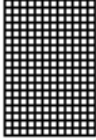
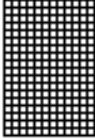
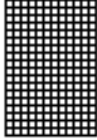
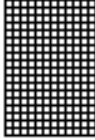
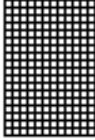
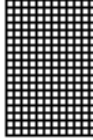
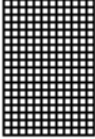
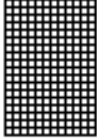
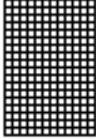
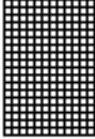
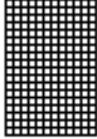
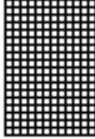
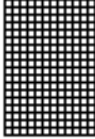
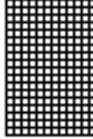
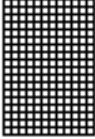
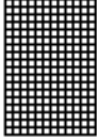
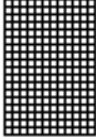
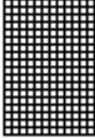
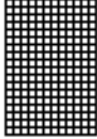
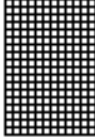
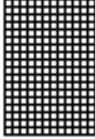
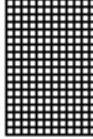
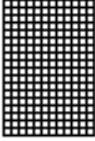
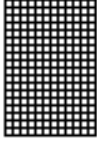
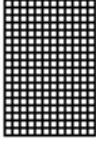
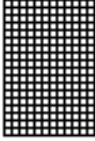
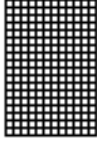
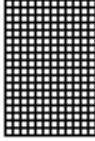
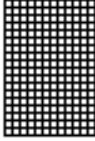
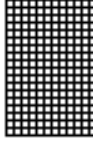
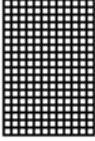
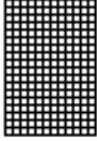
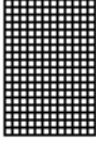
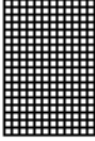
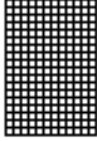
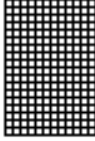
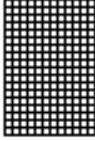
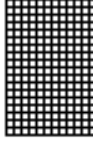
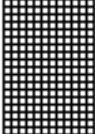
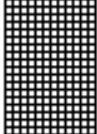
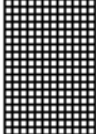
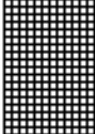
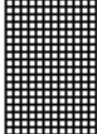
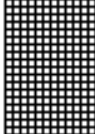
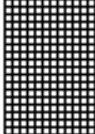
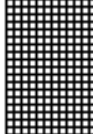

SCREEN CHARACTER and PATTERN DISPLAY CONTROLLERS

00 <sub>16</sub> 	01 <sub>16</sub> 	02 <sub>16</sub> 	03 <sub>16</sub> 	04 <sub>16</sub> 	05 <sub>16</sub> 	06 <sub>16</sub> 	07 <sub>16</sub> 
08 <sub>16</sub> 	09 <sub>16</sub> 	0A <sub>16</sub> 	0B <sub>16</sub> 	0C <sub>16</sub> 	0D <sub>16</sub> 	0E <sub>16</sub> 	0F <sub>16</sub> 
10 <sub>16</sub> 	11 <sub>16</sub> 	12 <sub>16</sub> 	13 <sub>16</sub> 	14 <sub>16</sub> 	15 <sub>16</sub> 	16 <sub>16</sub> 	17 <sub>16</sub> 
18 <sub>16</sub> 	19 <sub>16</sub> 	1A <sub>16</sub> 	1B <sub>16</sub> 	1C <sub>16</sub> 	1D <sub>16</sub> 	1E <sub>16</sub> 	1F <sub>16</sub> 
20 <sub>16</sub> 	21 <sub>16</sub> 	22 <sub>16</sub> 	23 <sub>16</sub> 	24 <sub>16</sub> 	25 <sub>16</sub> 	26 <sub>16</sub> 	27 <sub>16</sub> 
28 <sub>16</sub> 	29 <sub>16</sub> 	2A <sub>16</sub> 	2B <sub>16</sub> 	2C <sub>16</sub> 	2D <sub>16</sub> 	2E <sub>16</sub> 	2F <sub>16</sub> 
30 <sub>16</sub> 	31 <sub>16</sub> 	32 <sub>16</sub> 	33 <sub>16</sub> 	34 <sub>16</sub> 	35 <sub>16</sub> 	36 <sub>16</sub> 	37 <sub>16</sub> 
38 <sub>16</sub> 	39 <sub>16</sub> 	3A <sub>16</sub> 	3B <sub>16</sub> 	3C <sub>16</sub> 	3D <sub>16</sub> 	3E <sub>16</sub> 	3F <sub>16</sub> 

SCREEN CHARACTER and PATTERN DISPLAY CONTROLLERS

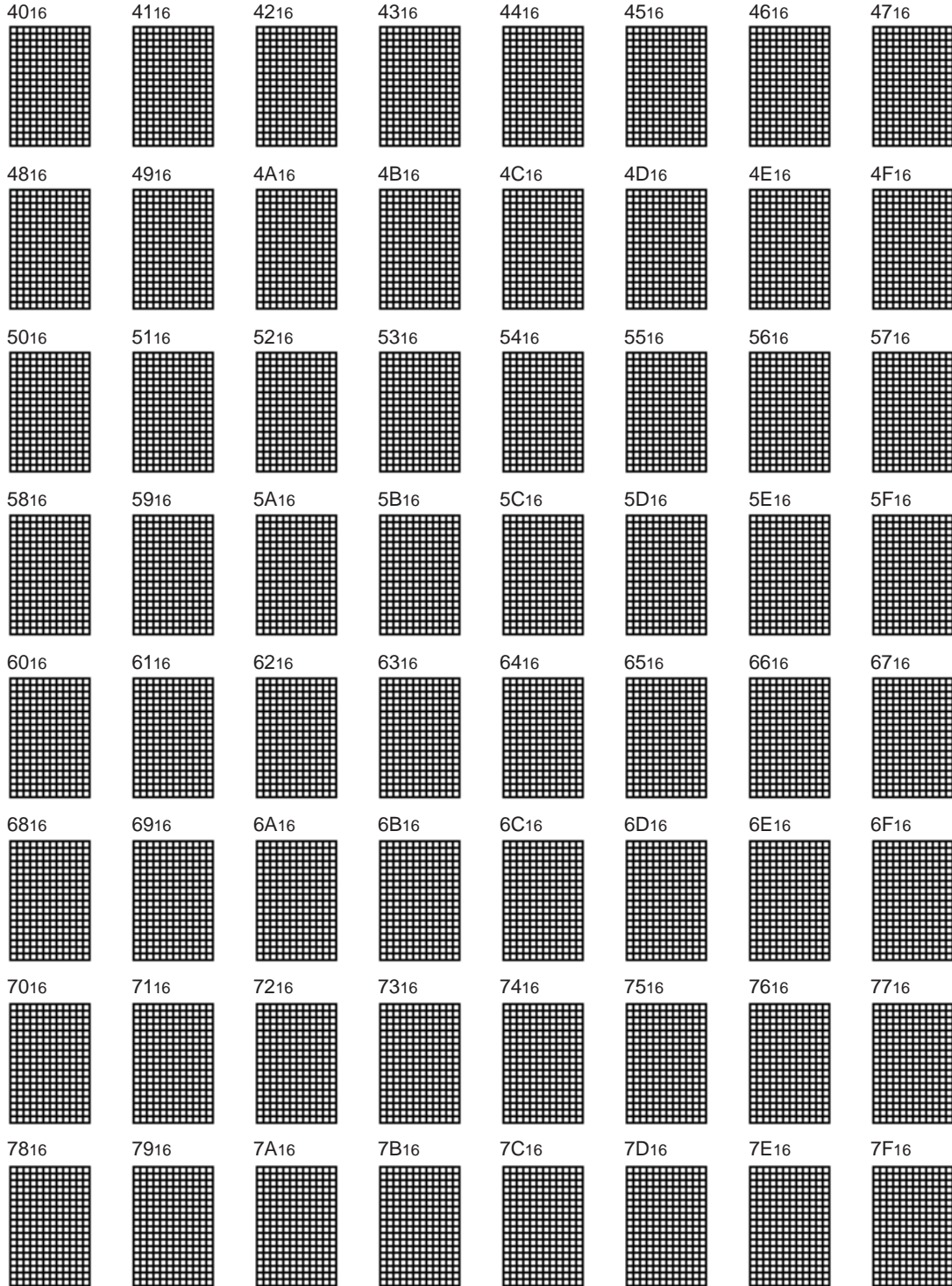



SCREEN CHARACTER and PATTERN DISPLAY CONTROLLERS

8016	8116	8216	8316	8416	8516	8616	8716
8816	8916	8A16	8B16	8C16	8D16	8E16	8F16
9016	9116	9216	9316	9416	9516	9616	9716
9816	9916	9A16	9B16	9C16	9D16	9E16	9F16
A016	A116	A216	A316	A416	A516	A616	A716
A816	A916	AA16	AB16	AC16	AD16	AE16	AF16
B016	B116	B216	B316	B416	B516	B616	B716
B816	B916	BA16	BB16	BC16	BD16	BE16	BF16

SCREEN CHARACTER and PATTERN DISPLAY CONTROLLERS

C016	C116	C216	C316	C416	C516	C616	C716
C816	C916	CA16	CB16	CC16	CD16	CE16	CF16
D016	D116	D216	D316	D416	D516	D616	D716
D816	D916	DA16	DB16	DC16	DD16	DE16	DF16
E016	E116	E216	E316	E416	E516	E616	E716
E816	E916	EA16	EB16	EC16	ED16	EE16	EF16
F016	F116	F216	F316	F416	F516	F616	F716
F816	F916	FA16	FB16	FC16	FD16	FE16	FF16 blank

3.(Page 1) Test patterns

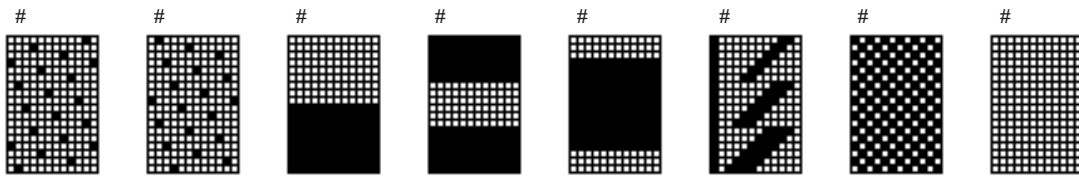

2.(Page 1) Character patterns

FF16 blank

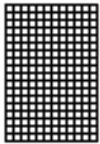

(See the next page)

SCREEN CHARACTER and PATTERN DISPLAY CONTROLLERS

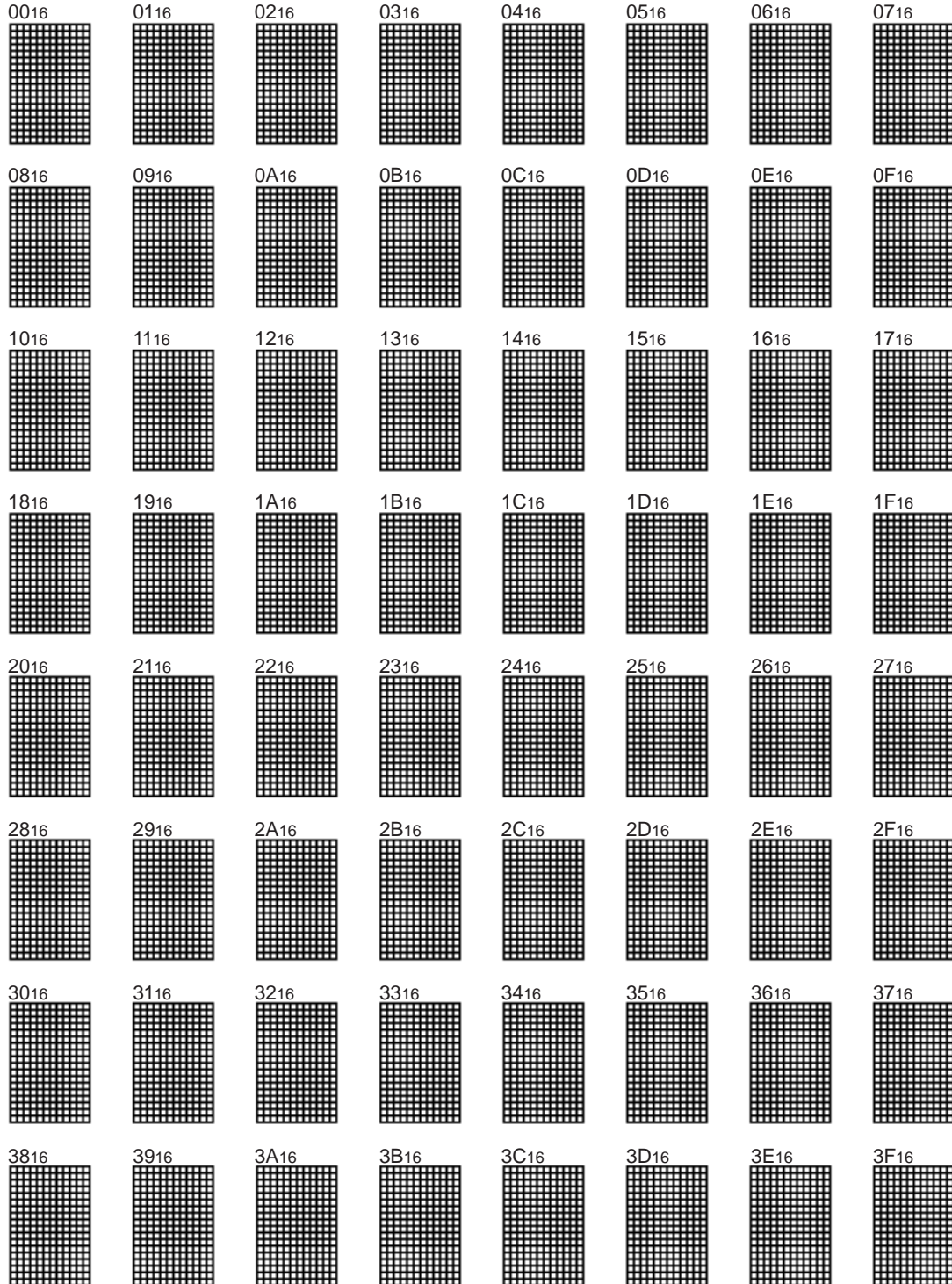

SCREEN CHARACTER and PATTERN DISPLAY CONTROLLERS

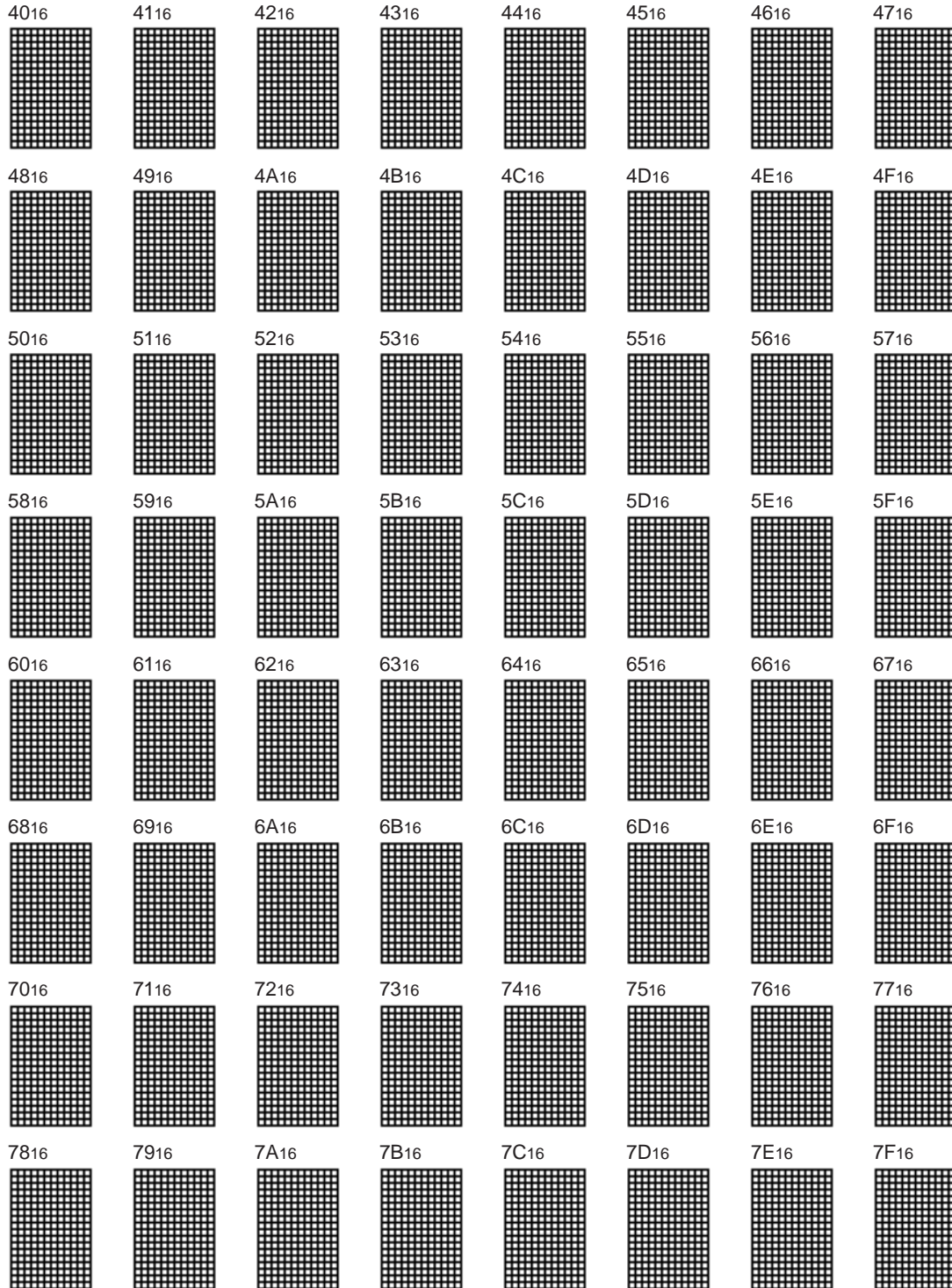

20P4B (20-PIN DIP) MARK SPECIFICATION FORM

Mitsubishi IC catalog name

Please choose one of the marking types below (A, B, C), and enter the Mitsubishi catalog name and the special mark (if needed).

A. Standard Mitsubishi Mark

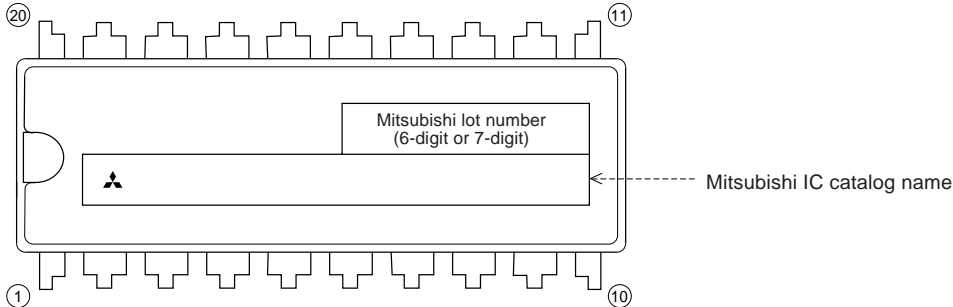

B. Customer's Parts Number + Mitsubishi catalog name

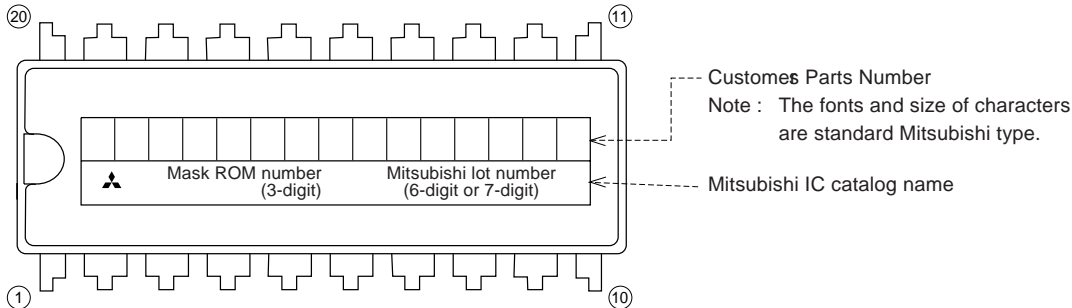

Note1 : The mark field should be written right aligned.

2 : The fonts and size of characters are standard Mitsubishi type.

3 : Customer's Parts Number can be up to 15 characters : Only 0 ~ 9, A ~ Z, +, -, /, (, ), &, @, . (periods), and , (commas) are usable.

4 : If the Mitsubishi logo is not required, check the box on the right.

Mitsubishi logo is not required

C. Special Mark Required

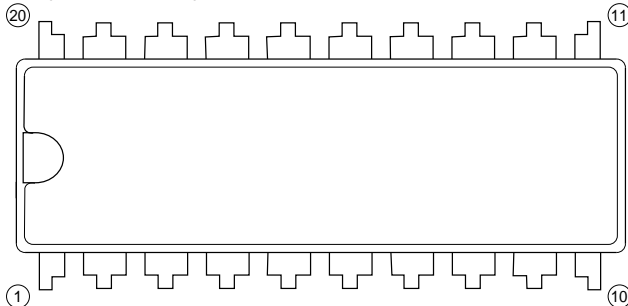

Note1 : If the Special Mark is to be Printed, indicate the desired layout of the mark in the upper figure. The layout will be duplicated as close as possible. Mitsubishi lot number (6-digit or 7-digit) and Mask ROM number (3-digit) are always marked.

2 : If the customer's trade mark logo must be used in the Special Mark, check the box on the right. Please submit a clean original of the logo. For the new special character fonts a clean font original (ideally logo drawing) must be submitted.

Special logo required



20P2Q-A (20-PIN SSOP) MARK SPECIFICATION FORM

Mitsubishi IC catalog name

Please choose one of the marking types below (A, B, C), and enter the Mitsubishi IC catalog name and the special mark (if needed).

A. Standard Mitsubishi Mark

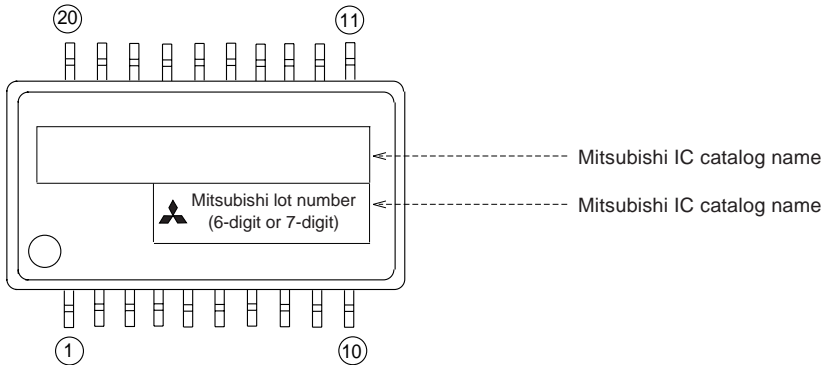

B. Customer's Parts Number + Mitsubishi IC Catalog Name

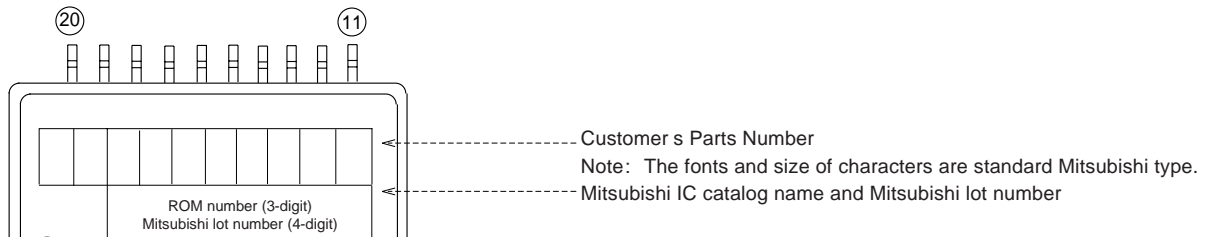

- Notes 1 : The mark field should be written right aligned.  
 2 : The fonts and size of characters are standard Mitsubishi type.  
 3 : Customer's Parts Number can be up to 10 characters: Only 0 to 9, A to Z, +, -, /, (, ), &, ', . (period), and , (comma) are usable.  
 4 : If the Mitsubishi logo is not required, check the box below.

Mitsubishi logo is not required

C. Special Mark Required

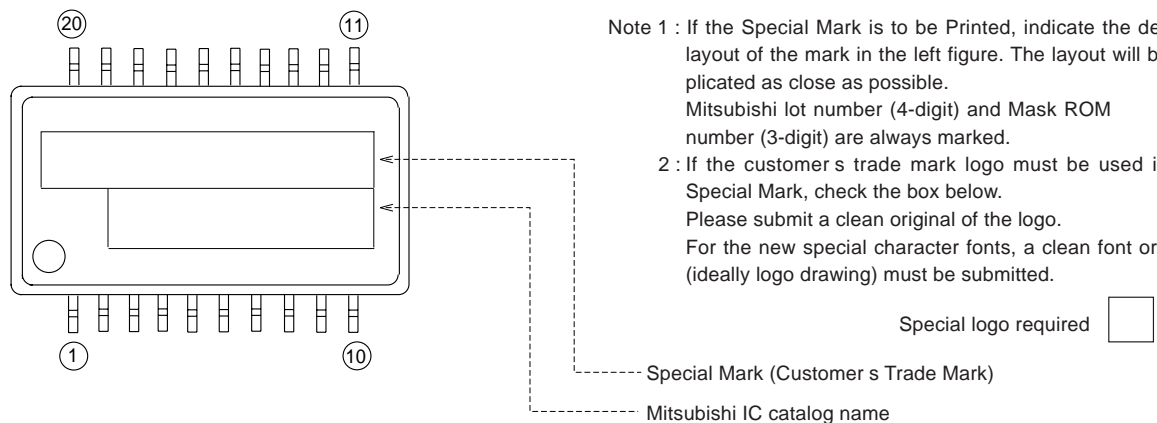

- Note 1 : If the Special Mark is to be Printed, indicate the desired layout of the mark in the left figure. The layout will be duplicated as close as possible.  
 Mitsubishi lot number (4-digit) and Mask ROM number (3-digit) are always marked.  
 2 : If the customer's trade mark logo must be used in the Special Mark, check the box below.  
 Please submit a clean original of the logo.  
 For the new special character fonts, a clean font original (ideally logo drawing) must be submitted.

Special logo required

PACKAGE OUTLINE

20P4B

Plastic 20pin 300mil SDIP

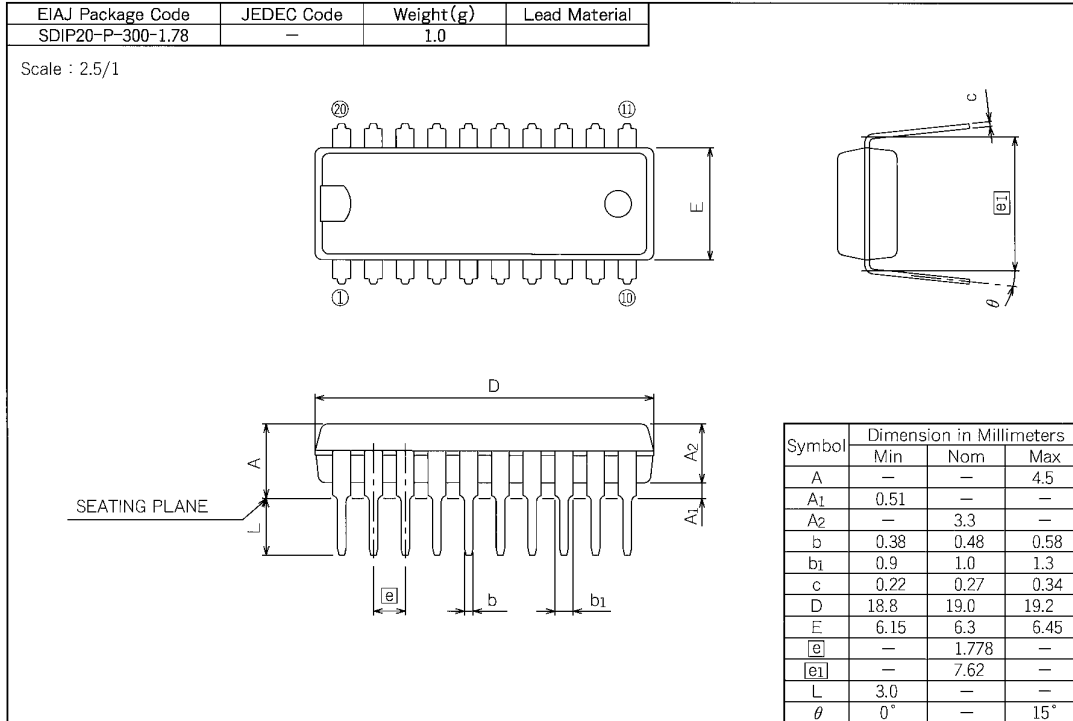

20P2Q-A

Plastic 20pin 300mil SSOP

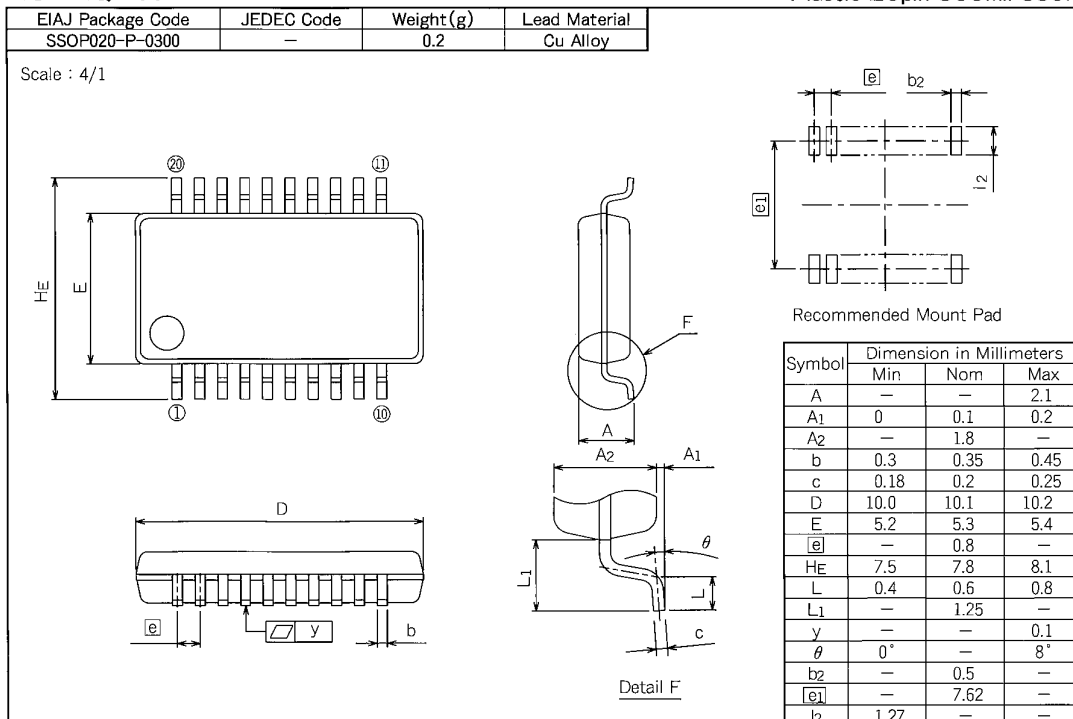





**Keep safety first in your circuit designs!**

- Mitsubishi Electric Corporation puts the maximum effort into making semiconductor products better and more reliable, but there is always the possibility that trouble may occur with them. Trouble with semiconductors may lead to personal injury, fire or property damage. Remember to give due consideration to safety when making your circuit designs, with appropriate measures such as (i) placement of substitute, auxiliary circuits, (ii) use of non-flammable material or (iii) prevention against any malfunction or mishap.

**Notes regarding these materials**

- These materials are intended as a reference to assist our customers in the selection of the Mitsubishi semiconductor product best suited to the customer's application; they do not convey any license under any intellectual property rights, or any other rights, belonging to Mitsubishi Electric Corporation or a third party.
- Mitsubishi Electric Corporation assumes no responsibility for any damage, or infringement of any third-party's rights, originating in the use of any product data, diagrams, charts, programs, algorithms, or circuit application examples contained in these materials.
- All information contained in these materials, including product data, diagrams, charts, programs and algorithms represents information on products at the time of publication of these materials, and are subject to change by Mitsubishi Electric Corporation without notice due to product improvements or other reasons. It is therefore recommended that customers contact Mitsubishi Electric Corporation or an authorized Mitsubishi Semiconductor product distributor for the latest product information before purchasing a product listed herein.
- The information described here may contain technical inaccuracies or typographical errors. Mitsubishi Electric Corporation assumes no responsibility for any damage, liability, or other loss rising from these inaccuracies or errors. Please also pay attention to information published by Mitsubishi Electric Corporation by various means, including the Mitsubishi Semiconductor home page (<http://www.mitsubishichips.com>).
- When using any or all of the information contained in these materials, including product data, diagrams, charts, programs, and algorithms, please be sure to evaluate all information as a total system before making a final decision on the applicability of the information and products. Mitsubishi Electric Corporation assumes no responsibility for any damage, liability or other loss resulting from the information contained herein.
- Mitsubishi Electric Corporation semiconductors are not designed or manufactured for use in a device or system that is used under circumstances in which human life is potentially at stake. Please contact Mitsubishi Electric Corporation or an authorized Mitsubishi Semiconductor product distributor when considering the use of a product contained herein for any specific purposes, such as apparatus or systems for transportation, vehicular, medical, aerospace, nuclear, or undersea repeater use.
- The prior written approval of Mitsubishi Electric Corporation is necessary to reprint or reproduce in whole or in part these materials.
- If these products or technologies are subject to the Japanese export control restrictions, they must be exported under a license from the Japanese government and cannot be imported into a country other than the approved destination.
- Any diversion or reexport contrary to the export control laws and regulations of Japan and/or the country of destination is prohibited.
- Please contact Mitsubishi Electric Corporation or an authorized Mitsubishi Semiconductor product distributor for further details on these materials or the products contained therein.

## REVISION DESCRIPTION LIST

M35071-XXXSP/FP DATA SHEET

Rev. No.	Revision Description	Rev. date
1.0	First Edition	980402
1.1	P47 20P2Q-A (20-PIN SSOP) MARK SPECIFICATION FORM B: Note 4 added	000707