

Single 8-Channel/Differential 4-Channel CMOS Analog Multiplexers

June 1994

Features

- This Circuit is Processed in Accordance to MIL-STD-883 and is Fully Conformant Under the Provisions of Paragraph 1.2.1.
- ON-Resistance 100Ω Maximum (+25°C)
- Low Power Consumption ($P_D < 11\text{mW}$)
- Fast Switching Action
 - $t_{\text{TRANS}} < 250\text{ns}$
 - $t_{\text{ON/OFF(EN)}} < 150\text{ns}$
- Low Charge Injection
- Upgrade from DG508A/DG509A
- TTL, CMOS Compatible
- Single or Split Supply Operation

Applications

- Data Acquisition Systems
- Audio Switching Systems
- Automatic Testers
- Hi-Rel Systems
- Sample and Hold Circuits
- Communication Systems
- Analog Selector Switch

Description

The DG408/883 Single 8-Channel and DG409/883 Differential 4-Channel monolithic CMOS analog multiplexers are drop-in replacements for the popular DG508A and DG509A series devices. They each include an array of eight analog switches, a TTL/CMOS compatible digital decode circuit for channel selection, a voltage reference for logic thresholds and an ENABLE input for device selection when several multiplexers are present.

The DG408/883 and DG409/883 feature lower signal ON resistance ($< 100\Omega$) and faster switch transition time ($t_{\text{TRANS}} < 250\text{ns}$) compared to the DG508A or DG509A. Charge injection has been reduced, simplifying sample and hold applications. The improvements in the DG408/883 series are made possible by using a high-voltage silicon-gate process. An epitaxial layer prevents the latch-up associated with older CMOS technologies. Power supplies may be single-ended from +5V to +34V, or split from $\pm 5\text{V}$ to $\pm 20\text{V}$.

The analog switches are bilateral, equally matched for AC or bidirectional signals. The ON resistance variation with analog signals is quite low over a $\pm 5\text{V}$ analog input range.

Ordering Information

PART NUMBER	TEMPERATURE RANGE	PACKAGE
DG408AK/883	-55°C to +125°C	16 Lead CerDIP
DG409AK/883	-55°C to +125°C	16 Lead CerDIP

Pinouts

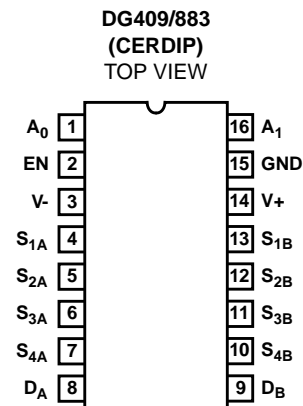
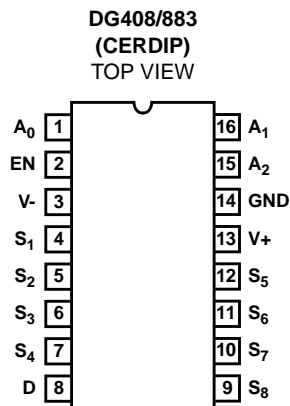

Functional Block Diagrams

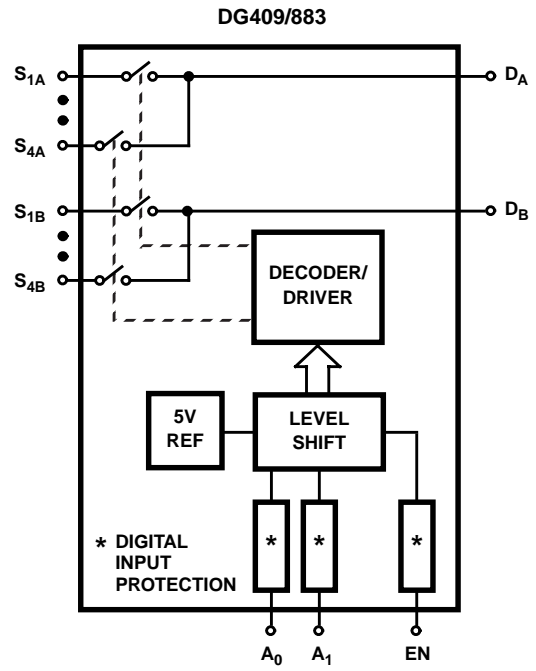
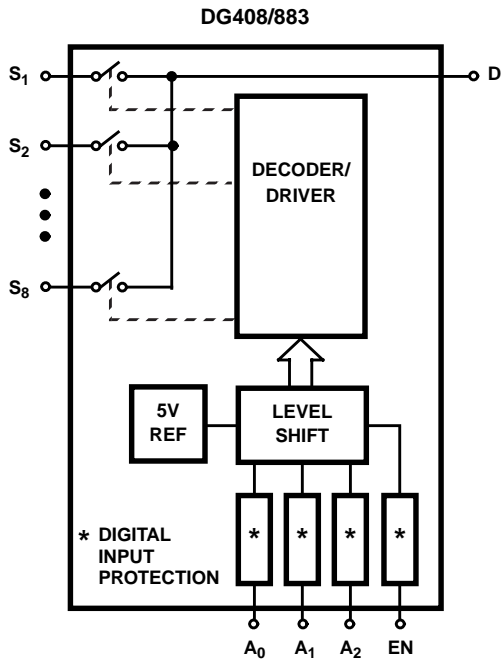

Pin Description - (DG408/883)

PIN	SYMBOL	DESCRIPTION
1	A ₀	Logic Decode Input (Bit 0, LSB)
2	EN	Enable Input
3	V-	Negative Power Supply Terminal
4	S ₁	Source (Input) for Channel 1
5	S ₂	Source (Input) for Channel 2
6	S ₃	Source (Input) for Channel 3
7	S ₄	Source (Input) for Channel 4
8	D	Drain (Output)
9	S ₈	Source (Input) for Channel 8
10	S ₇	Source (Input) for Channel 7
11	S ₆	Source (Input) for Channel 6
12	S ₅	Source (Input) for Channel 5
13	V+	Positive Power Supply Terminal (Substrate)
14	GND	Ground Terminal (Logic Common)
15	A ₂	Logic Decode Input (Bit 2, MSB)
16	A ₁	Logic Decode Input (Bit 1)

Pin Description - (DG409/883)

PIN	SYMBOL	DESCRIPTION
1	A ₀	Logic Decode Input (Bit 0, LSB)
2	EN	Enable Input
3	V-	NegActive Power Supply Terminal
4	S _{1A}	Source (Input) for Channel 1A
5	S _{2A}	Source (Input) for Channel 2A
6	S _{3A}	Source (Input) for Channel 3A
7	S _{4A}	Source (Input) for Channel 4A
8	D _A	Drain A (Output A)
9	D _B	Drain B (Output B)
10	S _{4B}	Source (Input) for Channel 4B
11	S _{3B}	Source (Input) for Channel 3B
12	S _{2B}	Source (Input) for Channel 2B
13	S _{1B}	Source (Input) for Channel 1B
14	V+	Positive Power Supply Terminal
15	GND	Ground Terminal (Logic Common)
16	A ₁	Logic Decode Input (Bit 1, MSB))

TRUTH TABLE DG408/883

A ₂	A ₁	A ₀	EN	ON SWITCH
X	X	X	0	NONE
0	0	0	1	1
0	0	1	1	2
0	1	0	1	3
0	1	1	1	4
1	0	0	1	5
1	0	1	1	6
1	1	0	1	7
1	1	1	1	8

TRUTH TABLE DG409/883

A ₁	A ₀	EN	ON SWITCH
X	X	0	NONE
0	0	1	1
0	1	1	2
1	0	1	3
1	1	1	4

NOTES:

1. V_{AH} Logic "1" ≥2.4V.
2. V_{AL} Logic "0" ≤0.8V.

Specifications DG408/883, DG409/883

Absolute Maximum Ratings

V+ to V-+44.0V
GND to V- 25V
Digital Inputs (Note 1) (V-) -2V to (V+) + 2V or 20mA, Whichever Occurs First
Current (Any Terminal, Except S or D)30mA
Continuous Current, S or D20mA
Peak Current, S or D (Pulsed 1ms, 10% Duty Cycle)40mA
Storage Temperature Range -65°C to +125°C
Lead Temperature (Soldering, 10s) +300°C

Thermal Information

Thermal Resistance	θ_{JA}	θ_{JC}
CerDIP Package	70°C/W	20°C/W
Operating Temperature	-55°C to +125°C	
Junction Temperature	+175°C	

CAUTION: Stresses above those listed in "Absolute Maximum Ratings" may cause permanent damage to the device. This is a stress only rating and operation of the device at these or any other conditions above those indicated in the operational sections of this specification is not implied.

TABLE 1. DC ELECTRICAL PERFORMANCE CHARACTERISTICS

Device Tested at: $-55^{\circ}\text{C} \leq T_A \leq +125^{\circ}\text{C}$, $V_+ = +15\text{V}$, $V_- = -15\text{V}$, Unless Otherwise Specified

PARAMETERS	SYMBOL	CONDITIONS	GROUP A SUBGROUP	TEMPERATURE	LIMITS		UNITS
					MIN	MAX	
Drain-Source ON Resistance	$r_{DS(ON)}$	$V_D = \pm 10\text{V}$, $V_{AL} = 0.8\text{V}$, $V_{AH} = 2.4\text{V}$, $I_S = -10\text{mA}$, Sequence Each Switch On	1, 3	+25°C, -55°C	-	100	Ω
			2	+125°C	-	125	Ω
Difference In Drain-Source ON Resistance Between Channels	$\Delta r_{DS(ON)}$	$V_D = \pm 10\text{V}$, $V_{AL} = 0.8\text{V}$, $V_{AH} = 2.4\text{V}$, $I_S = -10\text{mA}$, (Note 2)	1	+25°C	-	15	Ω
Source OFF Leakage Current	$I_{S(OFF)}$	$V_S = \pm 10\text{V}$, $V_D = \mp 10\text{V}$, $V_{EN} = 0\text{V}$	1	+25°C	-0.5	+0.5	nA
			2	+125°C	-50	+50	nA
Drain OFF Leakage Current DG408/883 DG409/883	$I_{D(OFF)}$	$V_S = \pm 10\text{V}$, $V_D = \mp 10\text{V}$, $V_{EN} = 0\text{V}$	1	+25°C	-1	+1	nA
			2	+125°C	-200	+200	nA
			1	+25°C	-1	+1	nA
			2	+125°C	-100	+100	nA
Drain ON Leakage Current DG408/883 DG409/883	$I_{D(ON)}$	$V_S = V_D = \pm 10\text{V}$, $V_{AL} = 0.8\text{V}$, $V_{AH} = 2.4\text{V}$, $V_{EN} = 2.4\text{V}$, Sequence Each Switch On	1	+25°C	-1	+1	nA
			2	+125°C	-200	+200	nA
			1	+25°C	-1	+1	nA
			2	+125°C	-150	+150	nA
Logic Input Current, Input Voltage High	I_{AH}	$V_{EN} = 0.8\text{V}$, $V_A = 2.4\text{V}$	1, 2, 3	+25°C, +125°C, -55°C	-10	+10	μA
		$V_{EN} = 0.8\text{V}$, $V_A = 15\text{V}$			-10	+10	μA
Logic Input Current, Input Voltage Low	I_{AL}	$V_{EN} = 0\text{V}$, $V_A = 0\text{V}$	1, 2, 3	+25°C, +125°C, -55°C	-10	+10	μA
		$V_{EN} = 2.4\text{V}$, $V_A = 0\text{V}$			-10	+10	μA
Positive Supply Current Standby	$I_{+(SB)}$	$V_{EN} = 0\text{V}$, $V_A = 0\text{V}$	1, 2, 3	+25°C, +125°C, -55°C	-	75	μA

Specifications DG408/883, DG409/883

TABLE 1. DC ELECTRICAL PERFORMANCE CHARACTERISTICS (Continued)

Device Tested at: $-55^{\circ}\text{C} \leq T_A \leq +125^{\circ}\text{C}$, $V_+ = +15\text{V}$, $V_- = -15\text{V}$, Unless Otherwise Specified

PARAMETERS	SYMBOL	CONDITIONS	GROUP A SUBGROUP	TEMPERATURE	LIMITS		UNITS
					MIN	MAX	
Negative Supply Current Standby	$I_{(SB)}$	$V_{EN} = 0\text{V}$, $V_A = 0\text{V}$	1, 2, 3	$+25^{\circ}\text{C}$, $+125^{\circ}\text{C}$, -55°C	-75	-	μA
Positive Supply Current	I_+	$V_{EN} = 2.4\text{V}$, $V_A = 0\text{V}$	1, 3	$+25^{\circ}\text{C}$, -55°C	-	0.5	mA
			2	$+125^{\circ}\text{C}$	-	2	mA
Negative Supply Current	I_-	$V_{EN} = 2.4\text{V}$, $V_A = 0\text{V}$	1, 2, 3	$+25^{\circ}\text{C}$, $+125^{\circ}\text{C}$, -55°C	-0.5	-	mA

TABLE 2. AC ELECTRICAL PERFORMANCE CHARACTERISTICS

Device Tested at: $-55^{\circ}\text{C} \leq T_A \leq +125^{\circ}\text{C}$, $V_+ = +15\text{V}$, $V_- = -15\text{V}$, Unless Otherwise Specified

PARAMETERS	SYMBOL	CONDITIONS	GROUP A SUBGROUP	TEMPERATURE	LIMITS		UNITS
					MIN	MAX	
Switching Time of Multiplexer	t_{TRANS}		9, 10, 11	$+25^{\circ}\text{C}$, $+125^{\circ}\text{C}$, -55°C	-	250	ns
Enable Turn ON Time	$t_{\text{ON(EN)}}$		9, 11	$+25^{\circ}\text{C}$, -55°C	-	150	ns
			10	$+125^{\circ}\text{C}$	-	225	ns
Enable Turn OFF Time	$t_{\text{OFF(EN)}}$		9, 10, 11	$+25^{\circ}\text{C}$, $+125^{\circ}\text{C}$, -55°C	-	150	ns
Break-Before-Make Interval	t_{OPEN}		9	$+25^{\circ}\text{C}$	10	-	ns

TABLE 3. ELECTRICAL PERFORMANCE CHARACTERISTICS

Table 3 Intentionally Left Blank.

TABLE 4. ELECTRICAL TEST REQUIREMENTS

MIL-STD-883 TEST REQUIREMENTS	SUBGROUPS (SEE TABLES 1 AND 2)
Interim Electrical Parameters (Pre Burn-In)	1
Final Electrical Test Parameters	1 (Note 3), 2, 3, 9, 10, 11
Group A Test Requirements	1, 2, 3, 9, 10, 11
Groups C and D Endpoints	1

NOTES:

1. Signals on S_X , D_X , or IN_X exceeding V_+ or V_- will be clamped by internal diodes. Limit forward diode current to maximum current ratings.
2. $\Delta r_{\text{DS(ON)}} = r_{\text{DS(ON)}} \text{ MAX} - r_{\text{DS(ON)}} \text{ MIN}$.
3. PDA applies to Subgroup 1 only.

Die Characteristics

DIE DIMENSIONS:

1800 μm x 3320 μm x 485 \pm 25 μm

METALLIZATION:

Type: SiAl

Thickness: 12k \AA \pm 1k \AA

GLASSIVATION:

Type: Nitride

Thickness: 8k \AA \pm 1k \AA

WORST CASE CURRENT DENSITY:

9.1 x 10⁴ A/cm²

Metallization Mask Layout

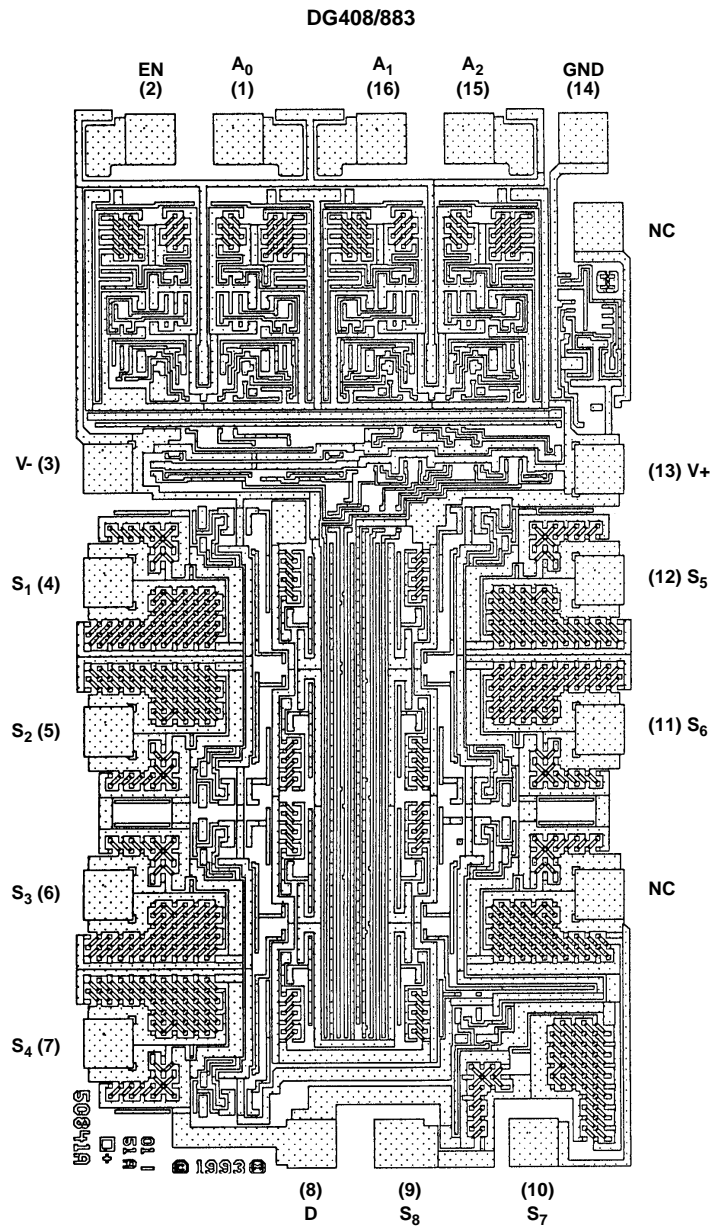

Die Characteristics

DIE DIMENSIONS:

1800 μm x 3320 μm x 485 \pm 25 μm

METALLIZATION:

Type: SiAl

Thickness: 12k \AA \pm 1k \AA

GLASSIVATION:

Type: Nitride

Thickness: 8k \AA \pm 1k \AA

WORST CASE CURRENT DENSITY:

9.1 x 10⁴ A/cm²

Metallization Mask Layout

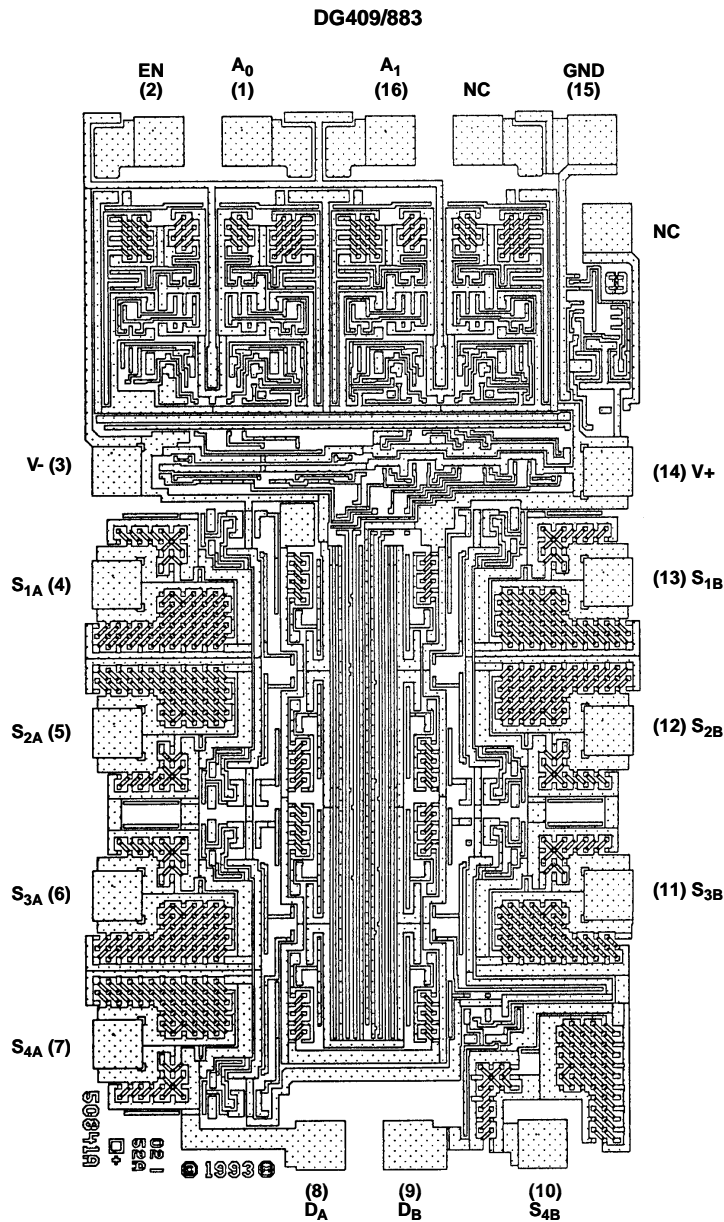

Test Circuits

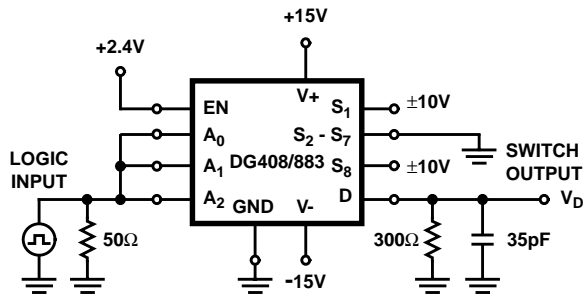

FIGURE 1A.

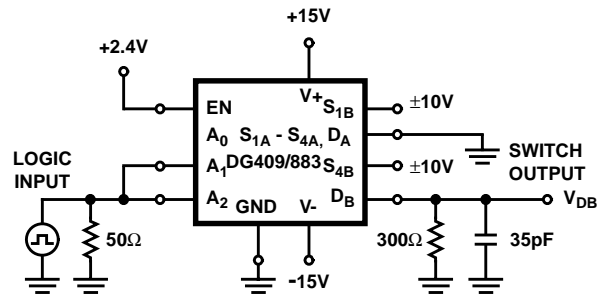

FIGURE 1B.

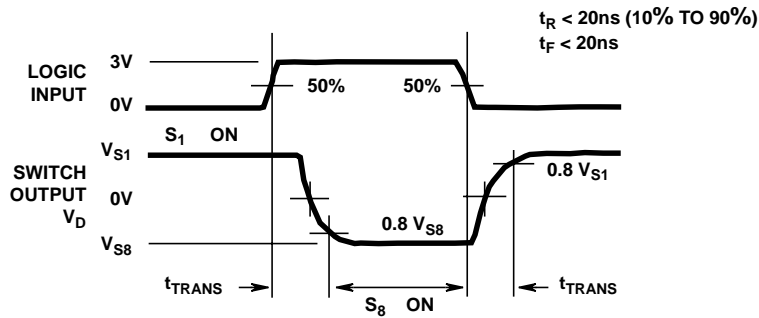

FIGURE 1C.

FIGURE 1. TRANSITION TIME

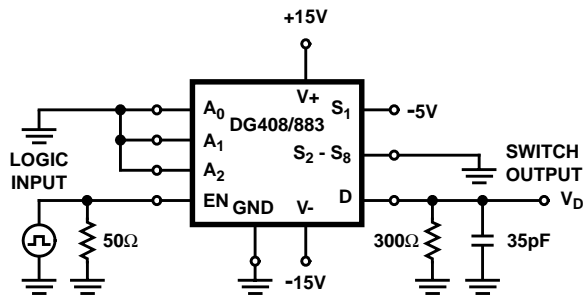

FIGURE 2A.

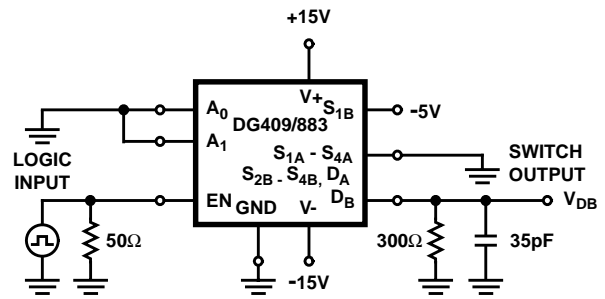

FIGURE 2B.

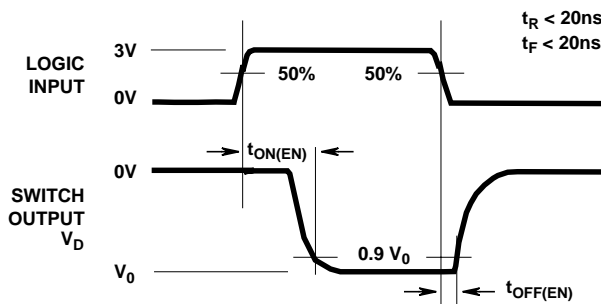

FIGURE 2C.

FIGURE 2. $t_{ON(EN)}$, $t_{OFF(EN)}$

Test Circuits (Continued)

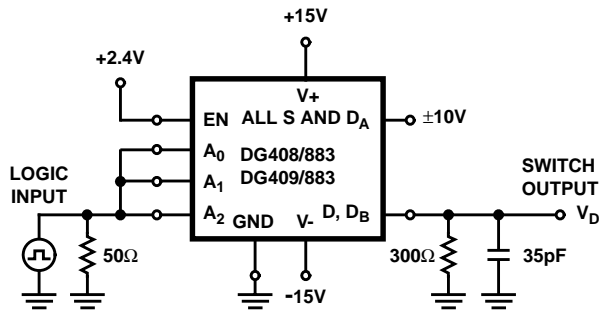

FIGURE 3A.

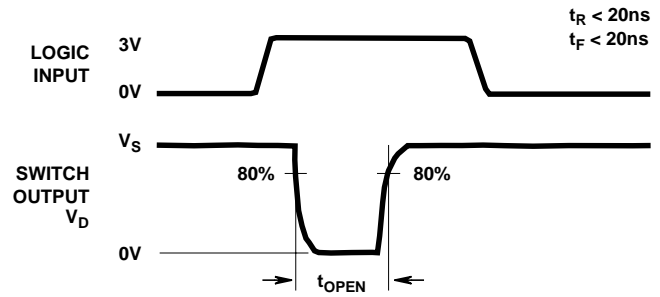
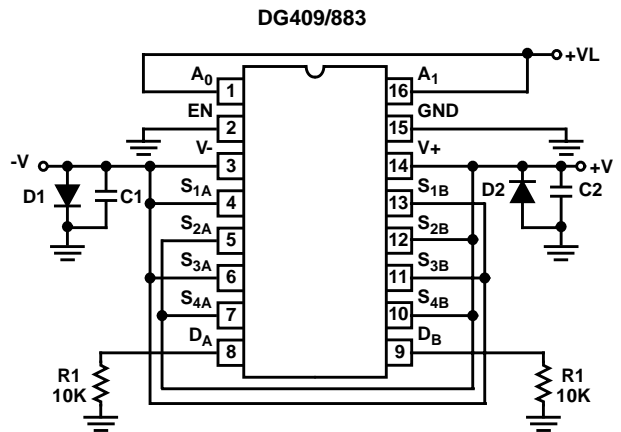
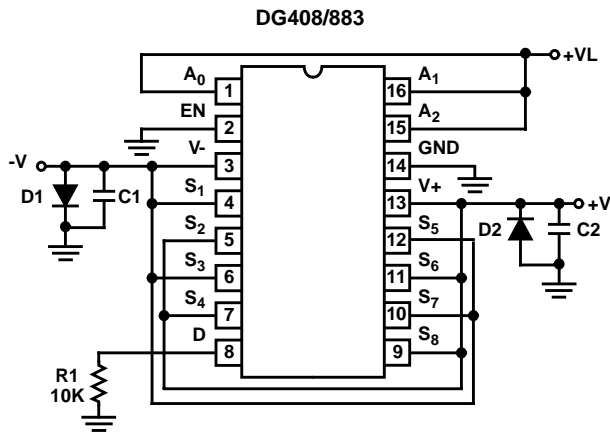

FIGURE 3B.

FIGURE 3. BREAK-BEFORE-MAKE INTERVAL

Burn-In Circuits



Ceramic Dual-In-Line Frit Seal Packages (CerDIP)

**F16.3 MIL-STD-1835 GDIP1-T16 (D-2, CONFIGURATION A)
16 LEAD CERAMIC DUAL-IN-LINE FRIT SEAL PACKAGE**

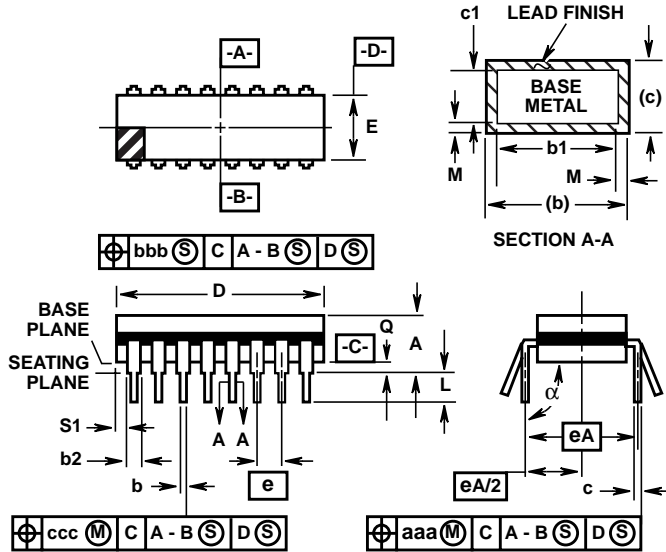

SYMBOL	INCHES		MILLIMETERS		NOTES
	MIN	MAX	MIN	MAX	
A	-	0.200	-	5.08	-
b	0.014	0.026	0.36	0.66	2
b1	0.014	0.023	0.36	0.58	3
b2	0.045	0.065	1.14	1.65	-
b3	0.023	0.045	0.58	1.14	4
c	0.008	0.018	0.20	0.46	2
c1	0.008	0.015	0.20	0.38	3
D	-	0.840	-	21.34	5
E	0.220	0.310	5.59	7.87	5
e	0.100 BSC		2.54 BSC		-
eA	0.300 BSC		7.62 BSC		-
eA/2	0.150 BSC		3.81 BSC		-
L	0.125	0.200	3.18	5.08	-
Q	0.015	0.060	0.38	1.52	6
S1	0.005	-	0.13	-	7
α	90°	105°	90°	105°	-
aaa	-	0.015	-	0.38	-
bbb	-	0.030	-	0.76	-
ccc	-	0.010	-	0.25	-
M	-	0.0015	-	0.038	2, 3
N	16		16		8

NOTES:

1. Index area: A notch or a pin one identification mark shall be located adjacent to pin one and shall be located within the shaded area shown. The manufacturer's identification shall not be used as a pin one identification mark.
2. The maximum limits of lead dimensions b and c or M shall be measured at the centroid of the finished lead surfaces, when solder dip or tin plate lead finish is applied.
3. Dimensions b1 and c1 apply to lead base metal only. Dimension M applies to lead plating and finish thickness.
4. Corner leads (1, N, N/2, and N/2+1) may be configured with a partial lead paddle. For this configuration dimension b3 replaces dimension b2.
5. This dimension allows for off-center lid, meniscus, and glass overrun.
6. Dimension Q shall be measured from the seating plane to the base plane.
7. Measure dimension S1 at all four corners.
8. N is the maximum number of terminal positions.
9. Dimensioning and tolerancing per ANSI Y14.5M - 1982.
10. Controlling dimension: INCH.

Rev. 0 4/94

DESIGN INFORMATION

August 1999

Single 8-Channel/Differential 4-Channel CMOS Analog Multiplexers

The information contained in this section has been developed through characterization by Intersil Semiconductor and is for use as application and design information only. No guarantee is implied.

Typical Performance Curves

INPUT LOGIC CURRENT vs LOGIC INPUT VOLTAGE

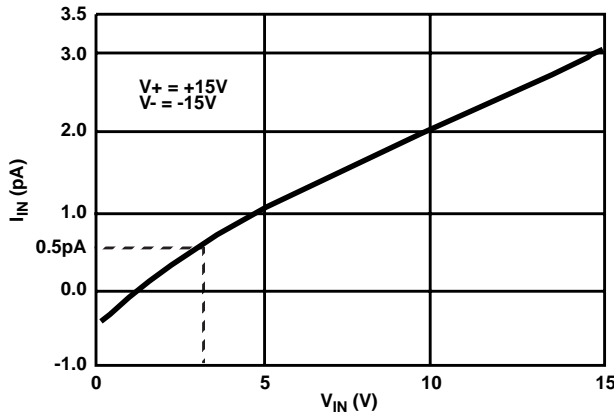

SOURCE/DRAIN CAPACITANCE vs ANALOG VOLTAGE
(SINGLE 12V SUPPLY)

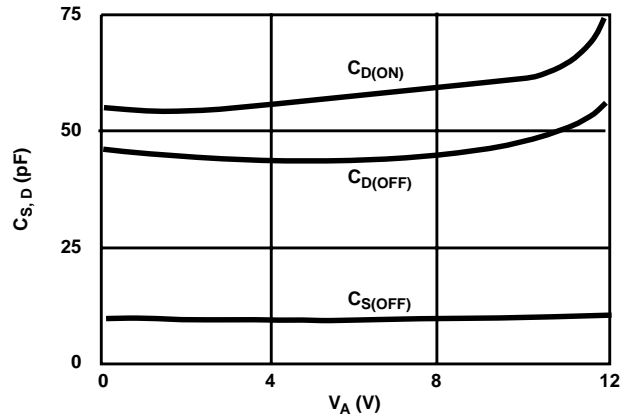

SOURCE/DRAIN CAPACITANCE vs ANALOG VOLTAGE

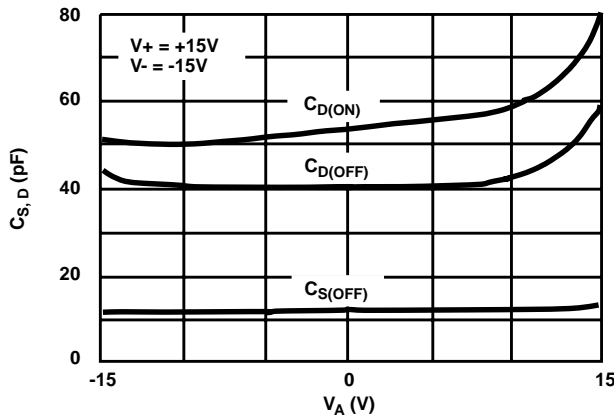

LOGIC INPUT CURRENT vs TEMPERATURE

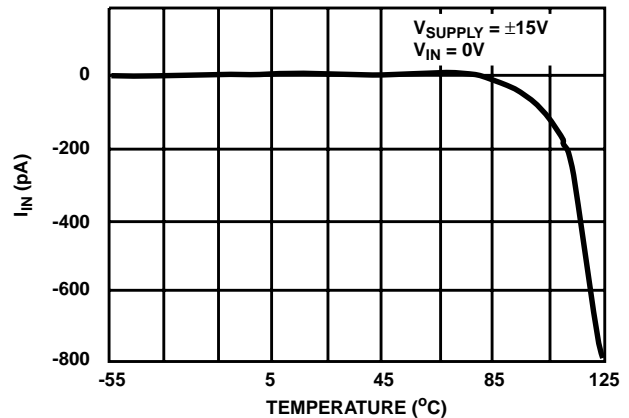

DRAIN LEAKAGE CURRENT vs SOURCE/DRAIN VOLTAGE
(SINGLE 12V SUPPLY)

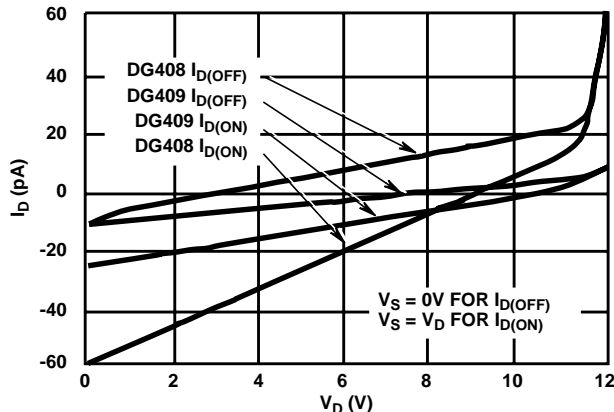

DRAIN LEAKAGE CURRENT vs SOURCE/DRAIN VOLTAGE

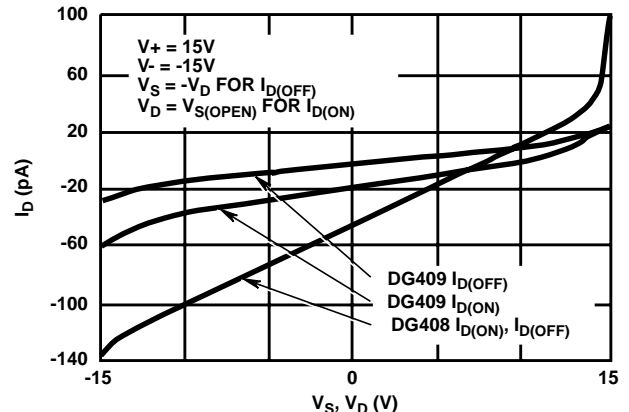

DESIGN INFORMATION (Continued)

The information contained in this section has been developed through characterization by Intersil Semiconductor and is for use as application and design information only. No guarantee is implied.

Typical Performance Curves (Continued)

SOURCE LEAKAGE CURRENT vs SOURCE VOLTAGE

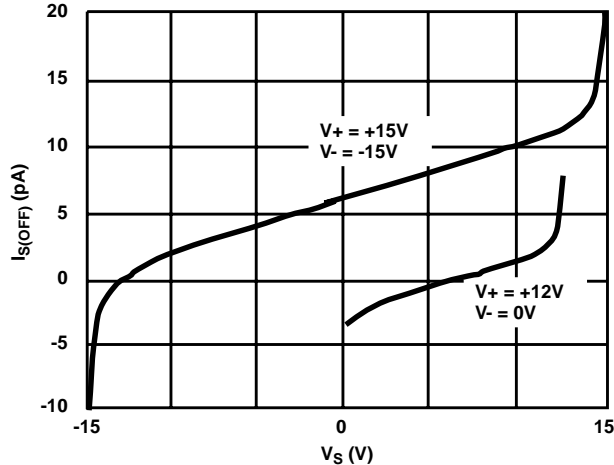

INPUT SWITCHING THRESHOLD vs SUPPLY VOLTAGE

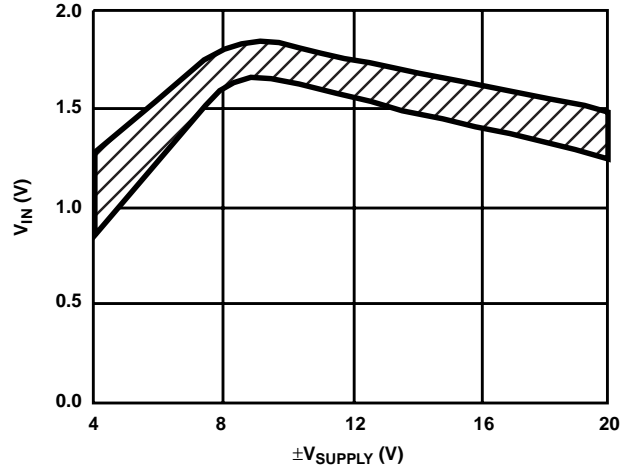

NEGATIVE SUPPLY CURRENT vs SWITCHING FREQUENCY

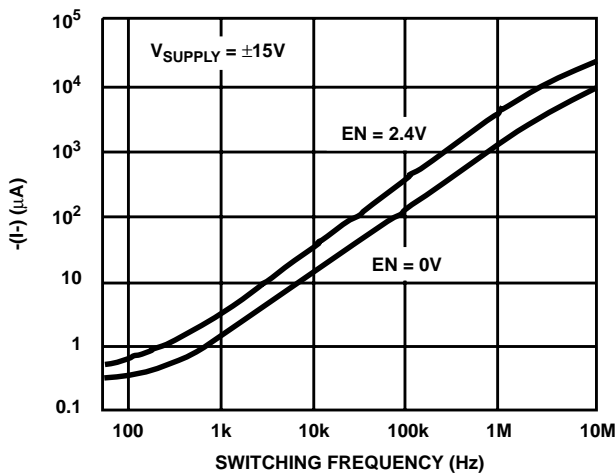

POSITIVE SUPPLY CURRENT vs SWITCHING FREQUENCY

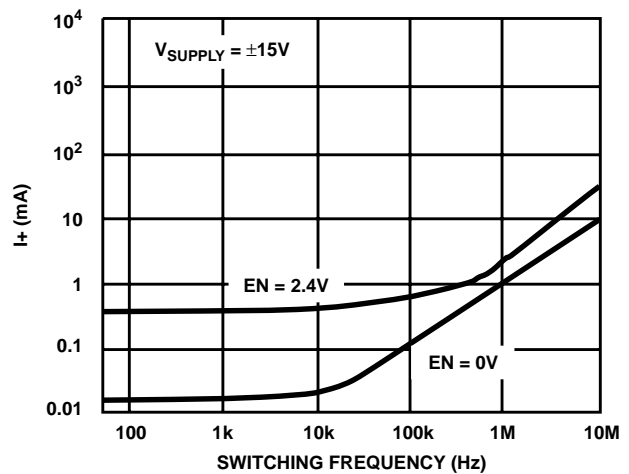

I_SUPPLY vs TEMPERATURE (LOG SCALE)

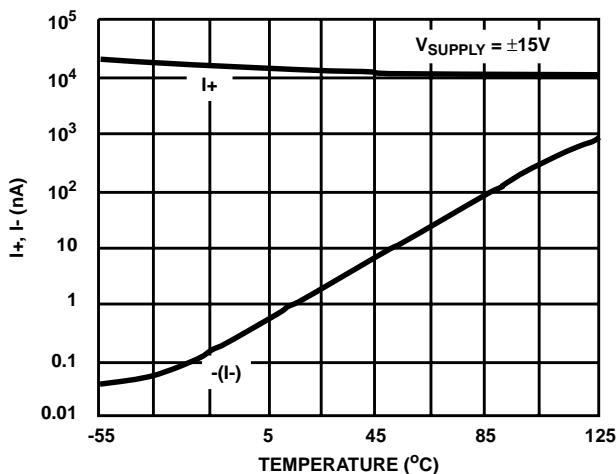

NEGATIVE SUPPLY CURRENT vs TEMPERATURE

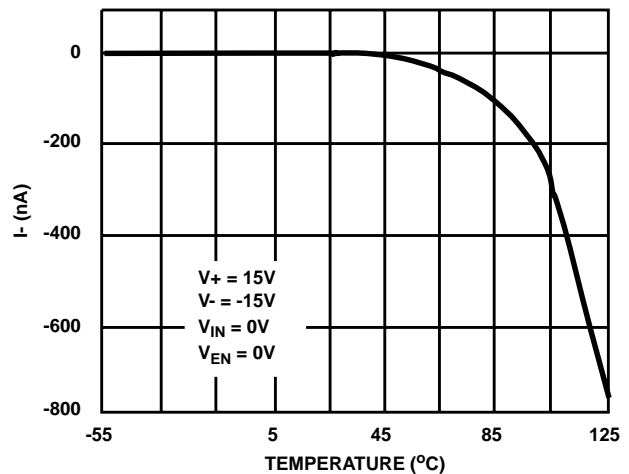

DESIGN INFORMATION (Continued)

The information contained in this section has been developed through characterization by Intersil Semiconductor and is for use as application and design information only. No guarantee is implied.

Typical Performance Curves (Continued)

POSITIVE SUPPLY CURRENT vs TEMPERATURE (DG408)

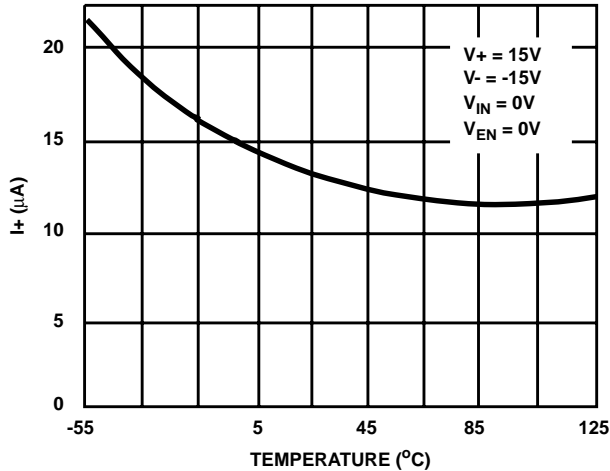

CHARGE INJECTION vs ANALOG VOLTAGE V_S (DG408, DG409)

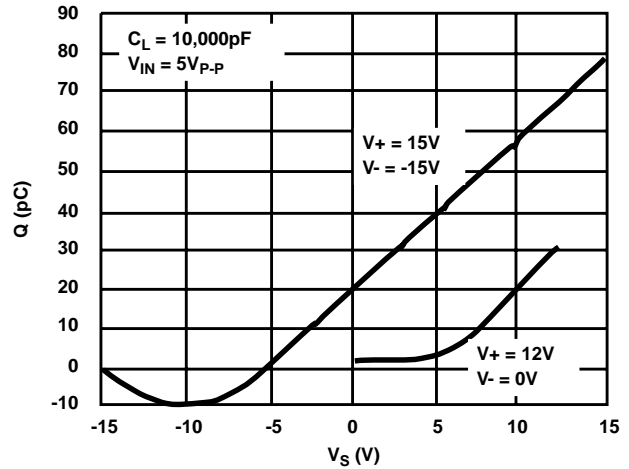

$r_{DS(ON)}$ vs V_D AND SUPPLY

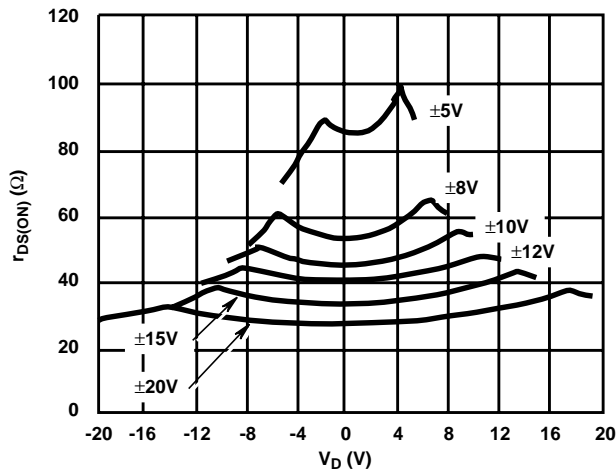

$r_{DS(ON)}$ vs V_D (SINGLE SUPPLY)

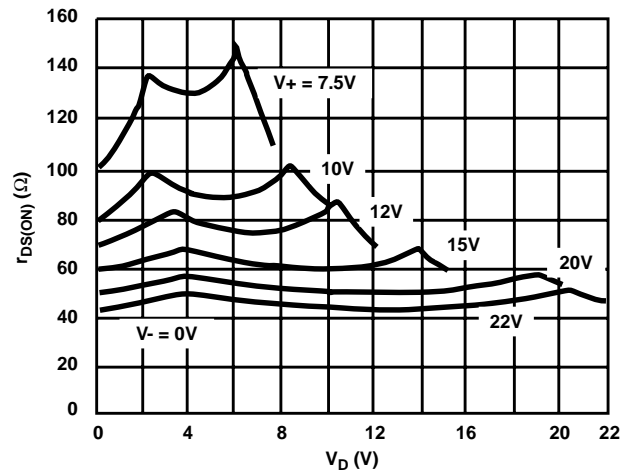

$r_{DS(ON)}$ vs V_S AND TEMPERATURE

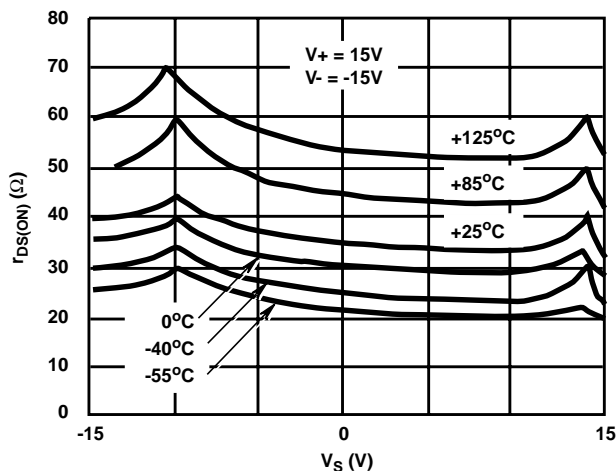

$r_{DS(ON)}$ vs V_S AND TEMPERATURE (SINGLE SUPPLY)

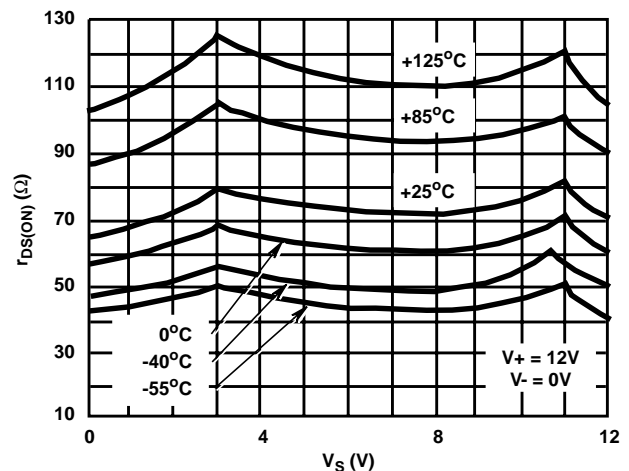

DESIGN INFORMATION (Continued)

The information contained in this section has been developed through characterization by Intersil Semiconductor and is for use as application and design information only. No guarantee is implied.

Typical Performance Curves (Continued)

OFF ISOLATION AND CROSSTALK vs FREQUENCY

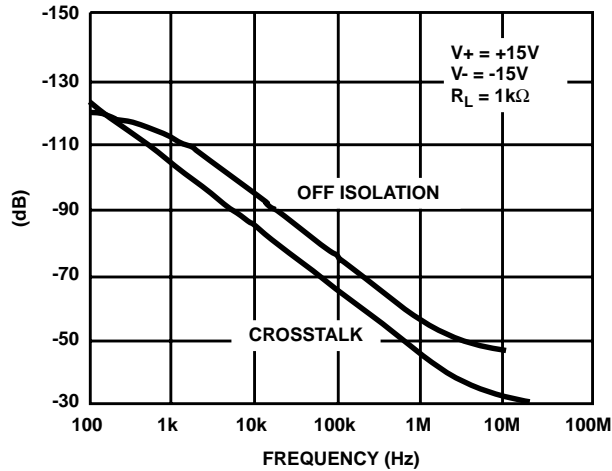

SWITCHING TIME vs SINGLE SUPPLY

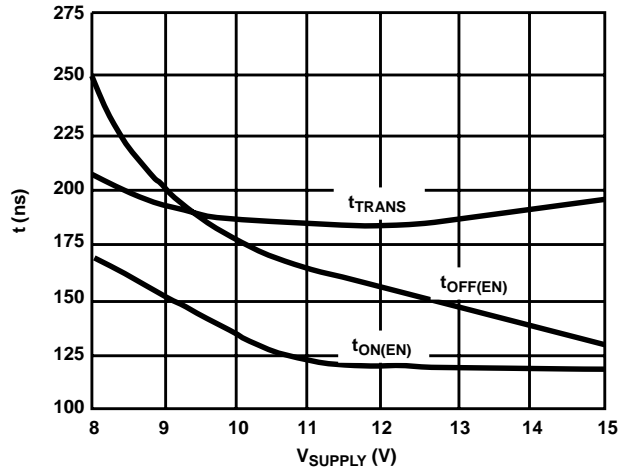

SWITCHING TIME vs BIPOLAR SUPPLY

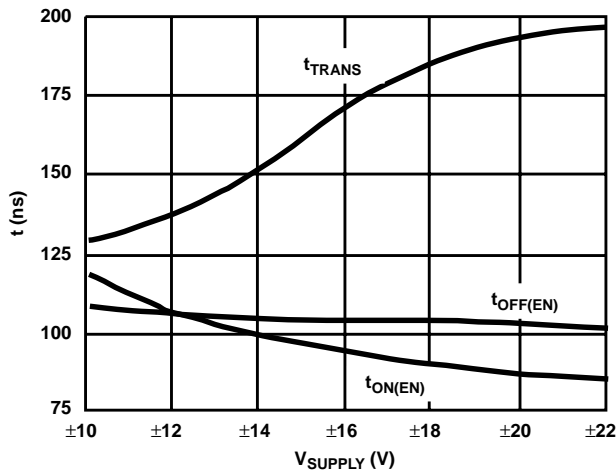

SWITCHING TIME vs V_{IN} (SINGLE SUPPLY)

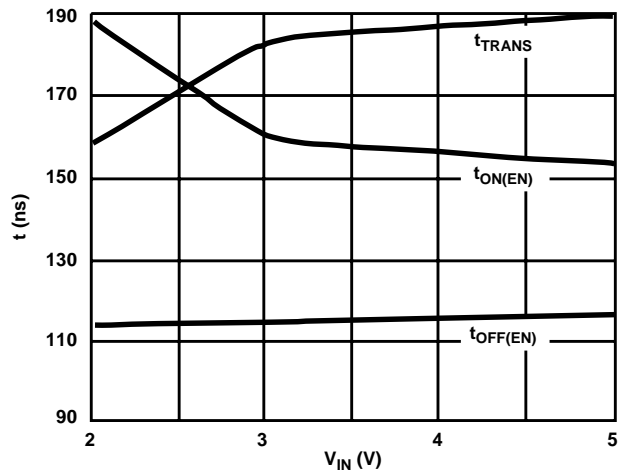

SWITCHING TIME vs V_{IN} (BIPOLAR SUPPLY)

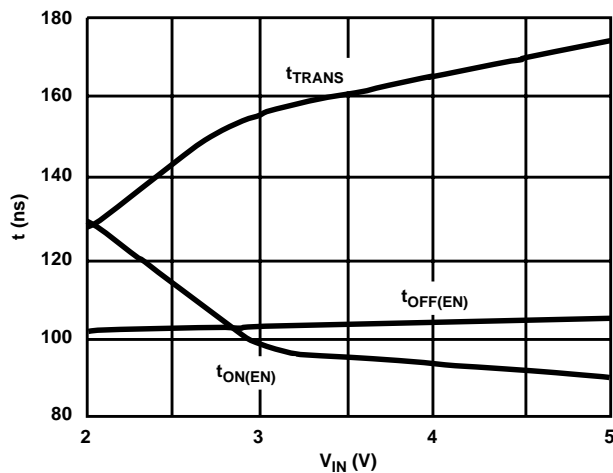

INSERTION LOSS vs FREQUENCY

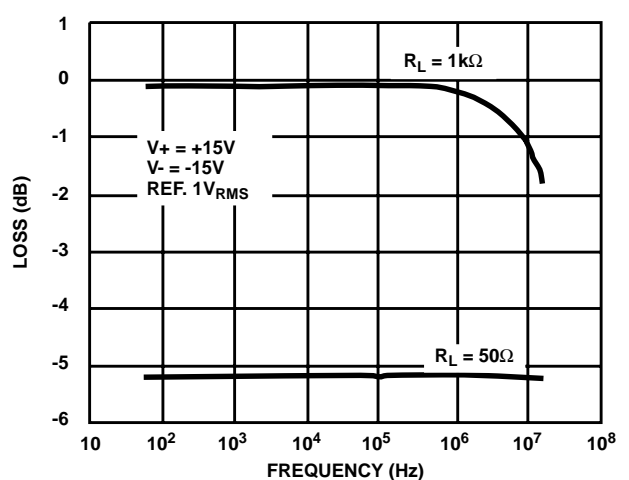

All Intersil semiconductor products are manufactured, assembled and tested under **ISO9000** quality systems certification.

Intersil products are sold by description only. Intersil Corporation reserves the right to make changes in circuit design and/or specifications at any time without notice. Accordingly, the reader is cautioned to verify that data sheets are current before placing orders. Information furnished by Intersil is believed to be accurate and reliable. However, no responsibility is assumed by Intersil or its subsidiaries for its use; nor for any infringements of patents or other rights of third parties which may result from its use. No license is granted by implication or otherwise under any patent or patent rights of Intersil or its subsidiaries.

For information regarding Intersil Corporation and its products, see web site <http://www.intersil.com>

Sales Office Headquarters

NORTH AMERICA

Intersil Corporation
P. O. Box 883, Mail Stop 53-204
Melbourne, FL 32902
TEL: (407) 724-7000
FAX: (407) 724-7240

EUROPE

Intersil SA
Mercure Center
100, Rue de la Fusee
1130 Brussels, Belgium
TEL: (32) 2.724.2111
FAX: (32) 2.724.22.05

ASIA

Intersil (Taiwan) Ltd.
Taiwan Limited
7F-6, No. 101 Fu Hsing North Road
Taipei, Taiwan
Republic of China
TEL: (886) 2 2716 9310
FAX: (886) 2 2715 3029