

## POSITIVE FIXED VOLTAGE REGULATOR

### DESCRIPTION

The SG7800A/SG7800 series of positive regulators offer self contained, fixed-voltage capability with up to 1.5A of load current and input voltage up to 50V (SG7800A series only). These units feature a unique on-chip trimming system to set the output voltages to within  $\pm 1.5\%$  of nominal on the SG7800A series,  $\pm 2.0\%$  on the SG7800 series. The SG7800A versions also offer much improved line and load regulation characteristics. Utilizing an improved Bandgap reference design, problems have been eliminated that are normally associated with the Zener diode references, such as drift in output voltage and large changes in the line and load regulation.

All protective features of thermal shutdown, current limiting, and safe-area control have been designed into these units and since these regulators require only a small output capacitor for satisfactory performance, ease of application is assured.

Although designed as fixed-voltage regulators, the output voltage can be increased through the use of a simple voltage divider. The low quiescent drain current of the device insures good regulation when this method is used.

Product is available in hermetically sealed TO-257, TO-3, TO39 and LCC packages.

### FEATURES

- Output voltage set internally to  $\pm 1.5\%$  on SG7800A
- Input voltage range to 50V max. on SG7800A
- Two volt input-output differential
- Excellent line and load regulation
- Foldback current limiting
- Thermal overload protection
- Voltages available: 5V, 12V, 15V
- Available in surface mount package

### HIGH RELIABILITY FEATURES - SG7800A/7800

- ◆ Available to MIL-STD - 883
- ◆ MIL-M38510/10702BXA - JAN7805T
- ◆ MIL-M38510/10703BXA - JAN7812T
- ◆ MIL-M38510/10704BXA - JAN7815T
- ◆ MIL-M38510/10706BYA - JAN7805K
- ◆ MIL-M38510/10707BYA - JAN7812K
- ◆ MIL-M38510/10708BYA - JAN7815K
- ◆ Radiation data available
- ◆ LMI level "S" processing available

### SCHEMATIC DIAGRAM

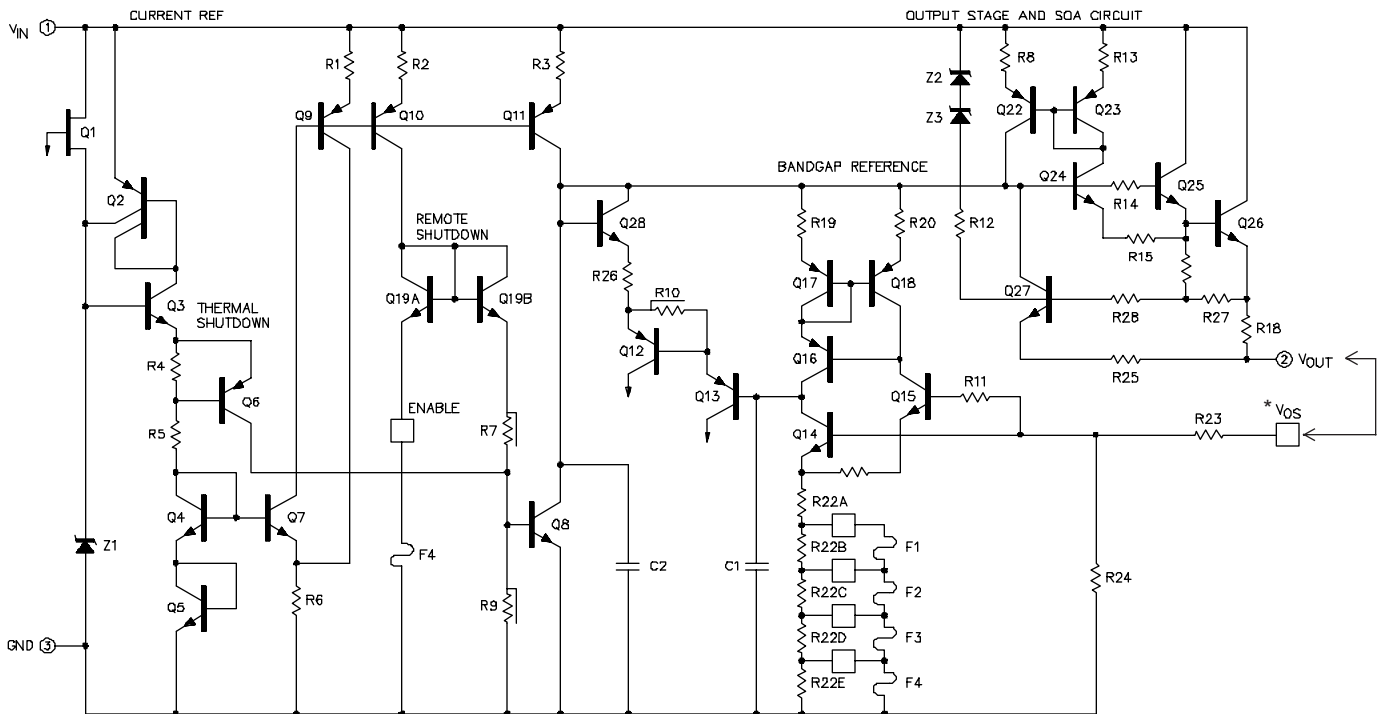

\* For normal operation the ( $V_{OS}$ ) sense pin must be externally connected to the load.

## ABSOLUTE MAXIMUM RATINGS (Note 1)

| Device Output Voltage | Input Voltage | Input Voltage (transient) (Note 3) | Input Voltage Differential (Output shorted to ground) |
|-----------------------|---------------|------------------------------------|---|
| 5V                    | 35V           | 50V                                | 35V   |
| 12V                   | 35V           | 50V                                | 35V   |
| 15V                   | 35V           | 50V                                | 35V   |

Operating Junction Temperature  
 Hermetic (K, T, IG & L - Packages) ..... 150°C

Storage Temperature Range ..... -65°C to 150°C  
 Lead Temperature (Soldering, 10 Seconds) ..... 300°C

Note 1. Values beyond which damage may occur.

## THERMAL DATA

K Package:

Thermal Resistance-Junction to Case,  $\theta_{JC}$  ..... 3.0°C/W  
 Thermal Resistance-Junction to Ambient,  $\theta_{JA}$  ..... 35°C/W

T Package:

Thermal Resistance-Junction to Case,  $\theta_{JC}$  ..... 15°C/W  
 Thermal Resistance-Junction to Ambient,  $\theta_{JA}$  ..... 120°C/W

IG Package:

Thermal Resistance-Junction to Case,  $\theta_{JC}$  ..... 3.5°C/W  
 Thermal Resistance-Junction to Ambient,  $\theta_{JA}$  ..... 42°C/W

L Package:

Thermal Resistance-Junction to Case,  $\theta_{JC}$  ..... 35°C/W  
 Thermal Resistance-Junction to Ambient,  $\theta_{JA}$  ..... 120°C/W

Note A. Junction Temperature Calculation:  $T_J = T_A + (P_D \times \theta_{JA})$ .

Note B. The above numbers for  $\theta_{JC}$  are maximums for the limiting thermal resistance of the package in a standard mounting configuration. The  $\theta_{JA}$  numbers are meant to be guidelines for the thermal performance of the device/pc-board system. All of the above assume no ambient airflow.

## RECOMMENDED OPERATING CONDITIONS (Note 2)

Operating Junction Temperature Range:  
 SG7800A/SG7800 ..... -55°C to 150°C

Note 2. Range over which the device is functional.

## CHARACTERISTIC CURVES

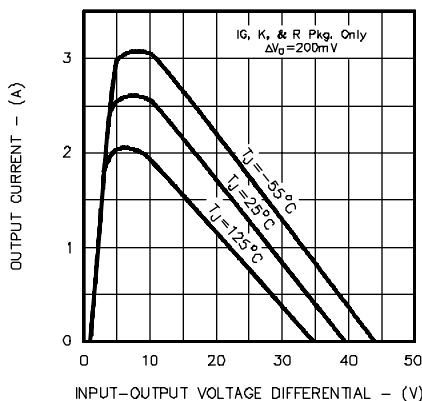

FIGURE 1.  
 PEAK OUTPUT CURRENT  
 VS. INPUT - OUTPUT DIFFERENTIAL

Note 3. Operation at high input voltages is dependent upon load current. When load current is less than 5mA, output will rise out of regulation as input-output differential increases beyond 30V. Note also from Figure 1, that maximum load current is reduced at high voltages. The 50V input rating of the SG140A series refers to ability to withstand high line or transient conditions without damage. Since the regulator's maximum current capability is reduced, the output may fall out of regulation at high input voltages under nominal loading.

## CHARACTERISTIC CURVES (continued)

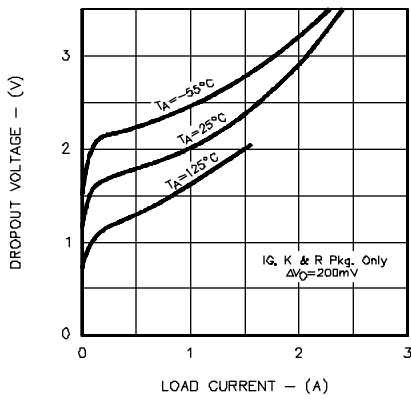

FIGURE 2. MINIMUM INPUT - OUTPUT VOLTAGE VS. LOAD CURRENT

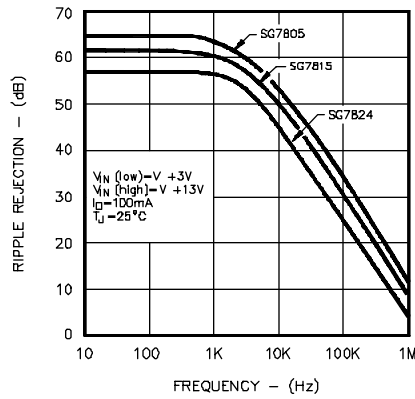

FIGURE 3. RIPPLE REJECTION VS. FREQUENCY

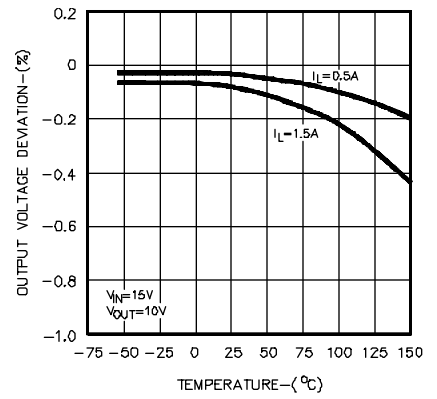
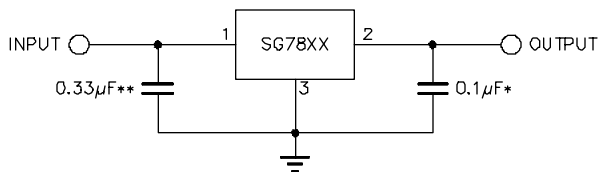

FIGURE 4. TEMPERATURE COEFFICIENT OF OUTPUT VOLTAGE

## APPLICATIONS



- \* INCREASING VALUE OF OUTPUT CAPACITOR IMPROVES SYSTEM TRANSIENT RESPONSE
- \*\* REQUIRED ONLY IF REGULATOR IS LOCATED AN APPRECIABLE DISTANCE FROM POWER SUPPLY FILTER

FIGURE 5 - FIXED OUTPUT REGULATOR

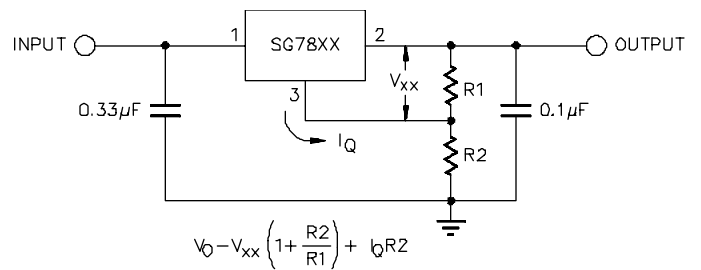

FIGURE 6 - CIRCUIT FOR INCREASING OUTPUT VOLTAGE

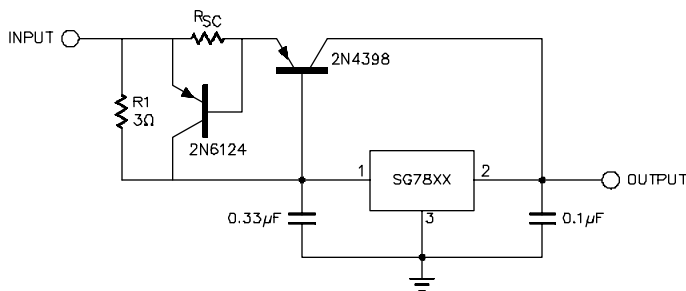

FIGURE 7 - HIGH OUTPUT CURRENT, SHORT CIRCUIT PROTECTED

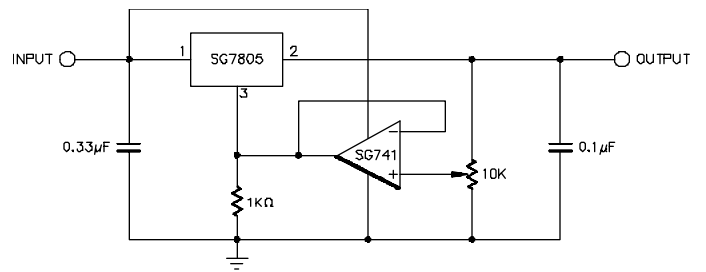

FIGURE 8 - ADJUSTABLE OUTPUT REGULATOR, 7V TO 30V

**ELECTRICAL SPECIFICATIONS** (Note 1)

(Unless otherwise specified, these specifications apply over the operating ambient temperatures for SG7805A/SG7805 with  $-55^{\circ}\text{C} \leq T_A \leq 150^{\circ}\text{C}$ ,  $V_{IN} = 10\text{V}$ ,  $I_O = 500\text{mA}$  for the K and IG -Power Packages-,  $I_O = 100\text{mA}$  for the T and L packages,  $C_{IN} = 0.33\mu\text{F}$ , and  $C_{OUT} = 0.1\mu\text{F}$ . Low duty cycle pulse testing techniques are used which maintains junction and case temperatures equal to the ambient temperature.)

**SG7805A/SG7805**

| Parameter                      | Test Conditions  | SG7805A |      |      | SG7805 |      |      | Units              |
|--------------------------------|--|---------|------|------|--------|------|------|--------------------|
|                                |  | Min.    | Typ. | Max. | Min.   | Typ. | Max. |                    |
| Output Voltage                 | $T_J = 25^{\circ}\text{C}$   | 4.92    | 5.00 | 5.08 | 4.80   | 5.00 | 5.20 | V                  |
| Line Regulation (Note 1)       | $V_{IN} = 7.5\text{V to } 20\text{V}$ , $T_J = 25^{\circ}\text{C}$   |         | 5    | 25   |        | 5    | 50   | mV                 |
|                                | $V_{IN} = 8\text{V to } 12\text{V}$ , $T_J = 25^{\circ}\text{C}$   |         | 2    | 12   |        | 2    | 25   | mV                 |
| Load Regulation (Note 1)       | Power Pkgs: $I_O = 5\text{mA to } 1.5\text{A}$ , $T_J = 25^{\circ}\text{C}$  |         | 15   | 50   |        | 15   | 50   | mV                 |
|                                | $I_O = 250\text{mA to } 750\text{mA}$ , $T_J = 25^{\circ}\text{C}$   |         | 5    | 25   |        | 5    | 25   | mV                 |
|                                | T - Pkg: $I_O = 5\text{mA to } 500\text{mA}$ , $T_J = 25^{\circ}\text{C}$  |         | 5    | 25   |        | 20   | 25   | mV                 |
| Total Output Voltage Tolerance | $V_{IN} = 8\text{V to } 20\text{V}$<br>Power Pkgs: $I_O = 5\text{mA to } 1.0\text{A}$ , $P \leq 20\text{W}$<br>T - Pkg: $I_O = 5\text{mA to } 500\text{mA}$ , $P \leq 2\text{W}$ | 4.85    | 5.00 | 5.15 | 4.65   | 5.00 | 5.35 | V                  |
| Quiescent Current              | Over Temperature Range<br>$T_J = 25^{\circ}\text{C}$   |         |      | 7    |        |      | 7    | mA                 |
|                                |  |         | 4    | 6    |        | 4    | 6    | mA                 |
| Quiescent Current Change       | With Line: $V_{IN} = 8\text{V to } 25\text{V}$<br>With Load: $I_O = 5\text{mA to } 1.0\text{A}$ (Power Pkgs.)<br>$I_O = 5\text{mA to } 500\text{mA}$ (T)                         |         |      | 0.8  |        |      | 0.8  | mA                 |
|                                |  |         |      | 0.5  |        |      | 0.5  | mA                 |
|                                |  |         |      | 0.5  |        |      | 0.5  | mA                 |
| Dropout Voltage                | $\Delta V_O = 100\text{mV}$ , $T_J = 25^{\circ}\text{C}$<br>Power Pkgs: $I_O = 1.0\text{A}$ , T - Pkg: $I_O = 500\text{mA}$  |         | 2    | 2.5  |        | 2    | 2.5  | V                  |
| Peak Output Current            | Power Pkgs: $V_{IN} = 10\text{V}$ , $T_J = 25^{\circ}\text{C}$<br>T - Pkg: $V_{IN} = 10\text{V}$ , $T_J = 25^{\circ}\text{C}$  | 1.5     | 2.0  | 3.3  | 1.5    | 2.0  | 3.3  | A                  |
|                                |  | 0.5     | 1.0  | 2.0  | 0.5    | 1.0  | 2.0  | A                  |
| Short Circuit Current          | Power Pkgs: $V_{IN} = 35\text{V}$ , $T_J = 25^{\circ}\text{C}$<br>T - Pkg: $V_{IN} = 35\text{V}$ , $T_J = 25^{\circ}\text{C}$  |         |      | 1.2  |        |      | 1.2  | A                  |
|                                |  |         |      | 0.7  |        |      | 0.7  | A                  |
| Ripple Rejection               | $\Delta V_{IN} = 10\text{V}$ , $f = 120\text{Hz}$ , $T_J = 25^{\circ}\text{C}$   | 68      |      |      | 68     |      |      | dB                 |
| Output Noise Voltage (rms)     | $f = 10\text{Hz to } 100\text{kHz}$ (Note 2)   |         |      | 40   |        |      | 40   | $\mu\text{V/V}$    |
| Long Term Stability            | 1000hrs. at $T_J = 125^{\circ}\text{C}$  |         | 20   |      |        | 20   |      | mV                 |
| Thermal Shutdown               | $I_O = 5\text{mA}$   |         | 175  |      |        | 175  |      | $^{\circ}\text{C}$ |

Note 1. All regulation tests are made at constant junction temperature with low duty cycle testing.  
2. This test is guaranteed but is not tested in production.

**ELECTRICAL SPECIFICATIONS** (Note 1)

(Unless otherwise specified, these specifications apply over the operating ambient temperatures for SG7812A/SG7812 with  $-55^{\circ}\text{C} \leq T_A \leq 150^{\circ}\text{C}$ ,  $V_{IN} = 19\text{V}$ ,  $I_O = 500\text{mA}$  for the K and IG -Power Packages-,  $I_O = 100\text{mA}$  for the T and L packages,  $C_{IN} = 0.33\mu\text{F}$ , and  $C_{OUT} = 0.1\mu\text{F}$ . Low duty cycle pulse testing techniques are used which maintains junction and case temperatures equal to the ambient temperature.)

**SG7812A/SG7812**

| Parameter                      | Test Conditions  | SG7812A |      |      | SG7812 |      |      | Units              |
|--------------------------------|--|---------|------|------|--------|------|------|--------------------|
|                                |  | Min.    | Typ. | Max. | Min.   | Typ. | Max. |                    |
| Output Voltage                 | $T_J = 25^{\circ}\text{C}$   | 11.8    | 12.0 | 12.2 | 11.5   | 12.0 | 12.5 | V                  |
| Line Regulation (Note 1)       | $V_{IN} = 14.5\text{V to }30\text{V}$ , $T_J = 25^{\circ}\text{C}$   |         | 12   | 60   |        | 12   | 120  | mV                 |
|                                | $V_{IN} = 16\text{V to }22\text{V}$ , $T_J = 25^{\circ}\text{C}$   |         | 6    | 30   |        | 6    | 60   | mV                 |
| Load Regulation (Note 1)       | Power Pkgs: $I_O = 5\text{mA to }1.5\text{A}$ , $T_J = 25^{\circ}\text{C}$   |         | 28   | 80   |        | 28   | 120  | mV                 |
|                                | $I_O = 250\text{mA to }750\text{mA}$ , $T_J = 25^{\circ}\text{C}$  |         | 10   | 40   |        | 10   | 60   | mV                 |
|                                | T - Pkg: $I_O = 5\text{mA to }500\text{mA}$ , $T_J = 25^{\circ}\text{C}$   |         | 10   | 40   |        | 10   | 60   | mV                 |
| Total Output Voltage Tolerance | $V_{IN} = 15.5\text{V to }27\text{V}$<br>Power Pkgs: $I_O = 5\text{mA to }1.0\text{A}$ , $P \leq 20\text{W}$<br>T - Pkg: $I_O = 5\text{mA to }500\text{mA}$ , $P \leq 2\text{W}$ | 11.7    | 12.0 | 12.3 | 11.4   | 12.0 | 12.6 | V                  |
| Quiescent Current              | Over Temperature Range<br>$T_J = 25^{\circ}\text{C}$   |         |      | 7    |        |      | 7    | mA                 |
|                                |  |         | 4    | 6    |        | 4    | 6    | mA                 |
| Quiescent Current Change       | With Line: $V_{IN} = 15\text{V to }30\text{V}$<br>With Load: $I_O = 5\text{mA to }1.0\text{A}$ (Power Pkgs.)<br>$I_O = 5\text{mA to }500\text{mA}$ (T)                           |         |      | 0.8  |        |      | 0.8  | mA                 |
|                                |  |         |      | 0.5  |        |      | 0.5  | mA                 |
|                                |  |         |      | 0.5  |        |      | 0.5  | mA                 |
| Dropout Voltage                | $\Delta V_O = 100\text{mV}$ , $T_J = 25^{\circ}\text{C}$<br>Power Pkgs: $I_O = 1.0\text{A}$ , T - Pkg: $I_O = 500\text{mA}$  |         | 2    | 2.5  |        | 2    | 2.5  | V                  |
| Peak Output Current            | Power Pkgs: $T_J = 25^{\circ}\text{C}$<br>T - Pkg: $T_J = 25^{\circ}\text{C}$  | 1.5     | 2.0  | 3.3  | 1.5    | 2.0  | 3.3  | A                  |
|                                |  | 0.5     | 1.0  | 1.7  | 0.5    | 1.0  | 1.7  | A                  |
| Short Circuit Current          | Power Pkgs: $V_{IN} = 35\text{V}$ , $T_J = 25^{\circ}\text{C}$<br>T - Pkg: $V_{IN} = 35\text{V}$ , $T_J = 25^{\circ}\text{C}$  |         |      | 1.2  |        |      | 1.2  | A                  |
|                                |  |         |      | 0.7  |        |      | 0.7  | A                  |
| Ripple Rejection               | $\Delta V_{IN} = 10\text{V}$ , $f = 120\text{Hz}$ , $T_J = 25^{\circ}\text{C}$   | 61      |      |      | 61     |      |      | dB                 |
| Output Noise Voltage (rms)     | $f = 10\text{Hz to }100\text{KHz}$ (Note 2)  |         |      | 40   |        |      | 40   | $\mu\text{V/V}$    |
| Long Term Stability            | 1000hrs. at $T_J = 125^{\circ}\text{C}$  |         | 48   |      |        | 48   |      | mV                 |
| Thermal Shutdown               | $I_O = 5\text{mA}$   |         | 175  |      |        | 175  |      | $^{\circ}\text{C}$ |

Note 1. All regulation tests are made at constant junction temperature with low duty cycle testing.  
2. This test is guaranteed but is not tested in production.

**ELECTRICAL SPECIFICATIONS** (Note 1)

(Unless otherwise specified, these specifications apply over the operating ambient temperatures for SG7815A/SG7815 with  $-55^{\circ}\text{C} \leq T_A \leq 150^{\circ}\text{C}$ ,  $V_{\text{IN}} = 23\text{V}$ ,  $I_{\text{O}} = 500\text{mA}$  for the K and IG -Power Packages-,  $I_{\text{O}} = 100\text{mA}$  for the T and L packages,  $C_{\text{IN}} = 0.33\mu\text{F}$ , and  $C_{\text{OUT}} = 0.1\mu\text{F}$ . Low duty cycle pulse testing techniques are used which maintains junction and case temperatures equal to the ambient temperature.)

**SG7815A/SG7815**

| Parameter                      | Test Conditions   | SG7815A |      |      | SG7815 |      |      | Units                  |
|--------------------------------|---|---------|------|------|--------|------|------|------------------------|
|                                |   | Min.    | Typ. | Max. | Min.   | Typ. | Max. |                        |
| Output Voltage                 | $T_J = 25^{\circ}\text{C}$  | 14.8    | 15.0 | 15.2 | 14.4   | 15.0 | 15.6 | V                      |
| Line Regulation (Note 1)       | $V_{\text{IN}} = 17.5\text{V}$ to $30\text{V}$ , $T_J = 25^{\circ}\text{C}$   |         | 15   | 75   |        | 15   | 150  | mV                     |
|                                | $V_{\text{IN}} = 20\text{V}$ to $26\text{V}$ , $T_J = 25^{\circ}\text{C}$   |         | 8    | 40   |        | 8    | 75   | mV                     |
| Load Regulation (Note 1)       | Power Pkgs: $I_{\text{O}} = 5\text{mA}$ to $1.5\text{A}$ , $T_J = 25^{\circ}\text{C}$   |         | 30   | 100  |        | 30   | 150  | mV                     |
|                                | $I_{\text{O}} = 250\text{mA}$ to $750\text{mA}$ , $T_J = 25^{\circ}\text{C}$  |         | 12   | 50   |        | 12   | 75   | mV                     |
|                                | T - Pkg: $I_{\text{O}} = 5\text{mA}$ to $500\text{mA}$ , $T_J = 25^{\circ}\text{C}$   |         | 12   | 50   |        | 12   | 75   | mV                     |
| Total Output Voltage Tolerance | $V_{\text{IN}} = 18.5\text{V}$ to $30\text{V}$<br>Power Pkgs: $I_{\text{O}} = 5\text{mA}$ to $1.0\text{A}$ , $P \leq 20\text{W}$<br>T - Pkg: $I_{\text{O}} = 5\text{mA}$ to $500\text{mA}$ , $P \leq 2\text{W}$ | 14.6    | 15.0 | 15.4 | 14.3   | 15.0 | 15.7 | V                      |
| Quiescent Current              | Over Temperature Range<br>$T_J = 25^{\circ}\text{C}$  |         |      | 7    |        |      | 7    | mA                     |
|                                | $T_J = 25^{\circ}\text{C}$  |         | 4    | 6    |        | 4    | 6    | mA                     |
| Quiescent Current Change       | With Line: $V_{\text{IN}} = 18.5\text{V}$ to $30\text{V}$<br>With Load: $I_{\text{O}} = 5\text{mA}$ to $1.0\text{A}$ (Power Pkgs.)<br>$I_{\text{O}} = 5\text{mA}$ to $500\text{mA}$ (T)                         |         |      | 0.8  |        |      | 0.8  | mA                     |
|                                |   |         |      | 0.5  |        |      | 0.5  | mA                     |
|                                |   |         |      | 0.5  |        |      | 0.5  | mA                     |
| Dropout Voltage                | $\Delta V_{\text{O}} = 100\text{mV}$ , $T_J = 25^{\circ}\text{C}$<br>Power Pkgs: $I_{\text{O}} = 1.0\text{A}$ , T - Pkg: $I_{\text{O}} = 500\text{mA}$  |         | 2    | 2.5  |        | 2    | 2.5  | V                      |
| Peak Output Current            | Power Pkgs: $T_J = 25^{\circ}\text{C}$<br>T - Pkg: $T_J = 25^{\circ}\text{C}$   | 1.5     | 2.2  | 3.3  | 1.5    | 2.2  | 3.3  | A                      |
|                                |   | 0.5     | 0.9  | 1.7  | 0.5    | 0.9  | 1.7  | A                      |
| Short Circuit Current          | Power Pkgs: $V_{\text{IN}} = 35\text{V}$ , $T_J = 25^{\circ}\text{C}$<br>T - Pkg: $V_{\text{IN}} = 35\text{V}$ , $T_J = 25^{\circ}\text{C}$   |         |      | 1.2  |        |      | 1.2  | A                      |
|                                |   |         |      | 0.7  |        |      | 0.7  | A                      |
| Ripple Rejection               | $\Delta V_{\text{IN}} = 10\text{V}$ , $f = 120\text{Hz}$ , $T_J = 25^{\circ}\text{C}$   | 60      |      |      | 60     |      |      | dB                     |
| Output Noise Voltage (rms)     | $f = 10\text{Hz}$ to $100\text{kHz}$ (Note 2)   |         |      | 40   |        |      | 40   | $\mu\text{V}/\text{V}$ |
| Long Term Stability            | 1000hrs. at $T_J = 125^{\circ}\text{C}$   |         | 60   |      |        | 60   |      | mV                     |
| Thermal Shutdown               | $I_{\text{O}} = 5\text{mA}$   |         | 175  |      |        | 175  |      | $^{\circ}\text{C}$     |

Note 1. All regulation tests are made at constant junction temperature with low duty cycle testing.

2. This test is guaranteed but is not tested in production.

## CONNECTION DIAGRAMS & ORDERING INFORMATION (See Notes Below)

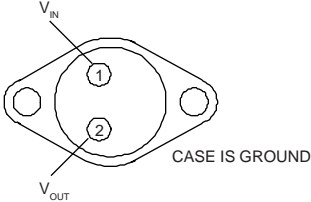
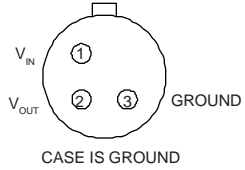
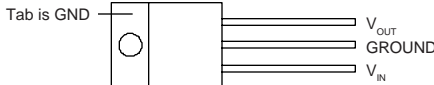
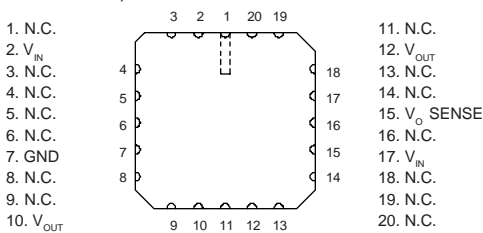
| Package  | Part No.   | Ambient Temperature Range  | Connection Diagram  |
|--|--|--|---|
| 3-TERMINAL TO-3 METAL CAN K-PACKAGE            | SG78XXAK/883B<br>SG7805AK/DESC<br>SG7812AK/DESC<br>SG7815AK/DESC<br>SG78XXAK<br>SG78XXK/883B<br>JAN7805K<br>JAN7812K<br>JAN7815K<br>SG78XXK<br>SG78XXK | -55°C to 125°C<br>-55°C to 125°C<br>-55°C to 125°C<br>-55°C to 125°C<br>-55°C to 125°C<br>-55°C to 125°C<br>-55°C to 125°C<br>-55°C to 125°C<br>-55°C to 125°C<br>-55°C to 125°C<br>0°C to 125°C |                        |
| 3-PIN TO-39 METAL CAN T-PACKAGE                | SG78XXAT/883B<br>SG7805AT/DESC<br>SG7812AT/DESC<br>SG7815AT/DESC<br>SG78XXAT<br>SG78XXT/883B<br>JAN7805T<br>JAN7812T<br>JAN7815T<br>SG78XXT            | -55°C to 125°C<br>-55°C to 125°C<br>-55°C to 125°C<br>-55°C to 125°C<br>-55°C to 125°C<br>-55°C to 125°C<br>-55°C to 125°C<br>-55°C to 125°C<br>-55°C to 125°C<br>-55°C to 125°C                 |                        |
| 3-PIN HERMETIC TO-257 IG-PACKAGE (Isolated)    | SG78XXAIG/883B<br>SG7805AIG/DESC<br>SG7812AIG/DESC<br>SG7815AIG/DESC<br>SG78XXAIG<br>SG78XXIG/883B<br>SG78XXIG   | -55°C to 125°C<br>-55°C to 125°C<br>-55°C to 125°C<br>-55°C to 125°C<br>-55°C to 125°C<br>-55°C to 125°C<br>-55°C to 125°C   |                       |
| 20-PIN CERAMIC LEADLESS CHIP CARRIER L-PACKAGE | SG7805AL/DESC<br>SG7812AL/DESC<br>SG7815AL/DESC<br>SG78XXL/883B  | -55°C to 125°C<br>-55°C to 125°C<br>-55°C to 125°C<br>-55°C to 125°C   | (See Notes 5 & 6)<br> |

- Note 1. Contact factory for JAN and DESC product availability.  
 2. All parts are viewed from the top.  
 3. "XX" to be replaced by output voltage of specific fixed regulator.  
 4. Some products will be available in hermetic flat pack (F). Consult factory for price and availability.  
 5. Both inputs and outputs must be externally connected together at the device terminals.  
 6. For normal operation, the  $V_o$  SENSE pin must be externally connected to the load.