

XC6203 Series

(Large Current) Positive Voltage Regulators



- ◆ CMOS Low Power Consumption (16 μ A max)
- ◆ Dropout Voltage : 150mV @ 100mA,
300mV @ 200mA
- ◆ Maximum Output Current
: more than 400mA (3.3V)
- ◆ Highly Accurate : $\pm 2\%$
- ◆ SOT-89 / SOT-223 / TO-92 Package

General Description

The XC6203E series are highly precise, low power consumption, positive voltage regulators manufactured using CMOS and laser trimming technologies.

The series provides large currents with a significantly small dropout voltage.

The XC6203E consists of a driver transistor, a precision reference voltage and an error amplifier. Output voltage is selectable in 0.1V steps between a voltage of 1.8V and 6.0V.

SOT-89 (500mW), SOT-223 (1200mW) and TO-92 (300mW) package.

Applications

- Battery Powered Equipment
- Reference Voltage Sources
- Cameras, Video Cameras
- CD-ROMs, DVDs
- Palmtops
- Portable Audio Video Equipment

Features

- Maximum Output Current : 400mA
- Maximum Operating Voltage : 8V
- Output Voltage Range : 1.8V ~ 6.0V
(selectable in 0.1V steps)
- Highly Accurate : $\pm 2\%$
- Low Power Consumption : TYP 8.0 μ A
- Output Voltage Temperature Characteristics : TYP ± 100 ppm/ $^{\circ}$ C
- Operational Temperature Range : -40° C ~ 85° C
- Ultra Small Packages : SOT-89, SOT223, TO-92

3

Typical Application Circuit

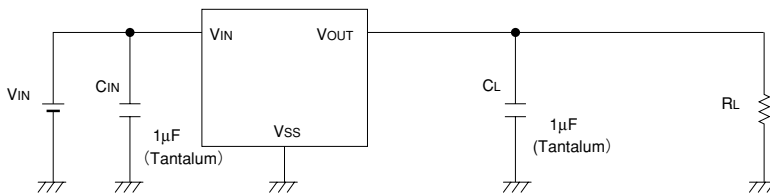

Typical Performance Characteristic

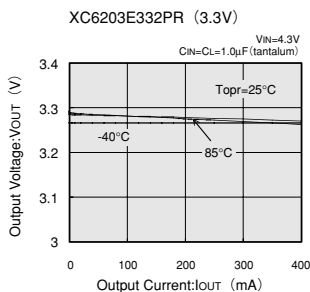

XC6203 Series

Pin Configuration

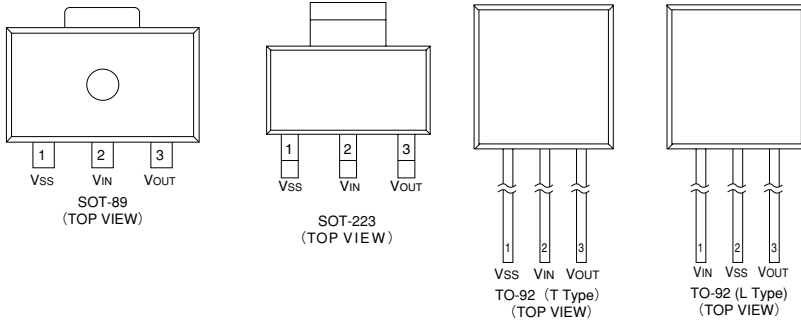

3

Pin Assignment

PIN NUMBER		PIN NAME	FUNCTION
SOT-89/SOT223/TO-92 (T)	TO-92 (L)		
1	2	Vss	Ground
2	1	VIN	Power Input
3	3	VOUT	Output

Product Classification

Ordering Information

XC6203 ①②③④⑤⑥

DESIGNATOR	SYMBOL	DESCRIPTION	DESIGNATOR	SYMBOL	DESCRIPTION
①	Type of Regulator		⑤	Package Type	
	P	Current limiter circuit built-in		P	SOT-89
	E	No current limiter circuit built-in		F	SOT-223
				T	TO-92 (Standard)
②③④	18~60 & A	e.g. 252 : 2.5V, Accuracy $\pm 2\%$ 28A : 2.85V, Accuracy $\pm 2\%$ "A" indicates voltage of 50mV steps	⑥	L	TO-92 (Custom pin configuration)
				Device Orientation	
				R	Embossed Tape (Standard Feed)
				L	Embossed Tape (Reverse Feed)
				H	Paper Type (TO-92)
			B	Bag (TO-92)	

Note*: Output Voltage in 50mV steps is applied only for 2.85V type.
Accuracy of $\pm 1\%$ is available as custom-designed products.

■ Packaging Information

● SOT-89

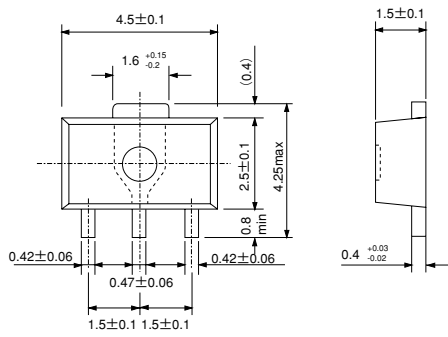

3

● SOT-223

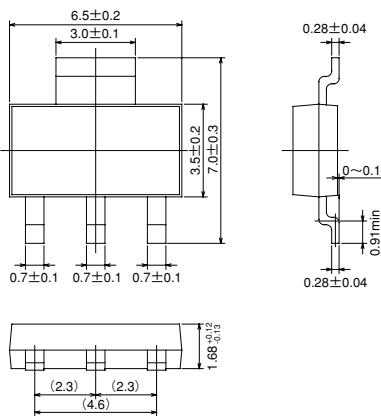

XC6203 Series

●TO-92

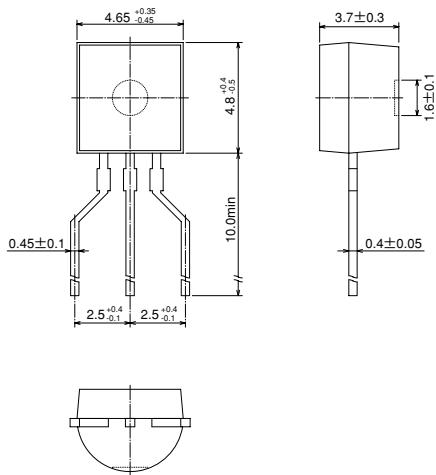

3

■ Marking

● SOT-89, SOT-223

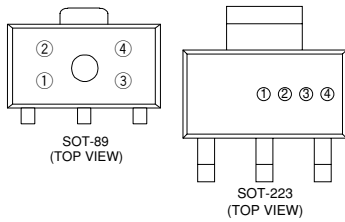

① Represents the product name

DESIGNATOR	PRODUCT NAME
3	XC6203 * * * * *

② Represents the type of regulator

DESIGNATOR			PRODUCT NAME
VOLTAGE=0.1~3.0V	VOLTAGE=3.1~6.0V	VOLTAGE=2.85V	
5	6	7	XC6203P * * * * *
2	3	4	XC6203E * * * * *

③ Represents the output voltage

DESIGNATOR	OUTPUT VOLTAGE (V)			DESIGNATOR	OUTPUT VOLTAGE (V)		
	—	—	—		—	—	—
0	—	3.1	—	F	—	4.6	—
1	—	3.2	—	H	—	4.7	—
2	—	3.3	—	K	1.8	4.8	—
3	—	3.4	—	L	1.9	4.9	—
4	—	3.5	—	M	2.0	5.0	—
5	—	3.6	—	N	2.1	5.1	—
6	—	3.7	—	P	2.2	5.2	—
7	—	3.8	—	R	2.3	5.3	—
8	—	3.9	—	S	2.4	5.4	—
9	—	4.0	—	T	2.5	5.5	—
A	—	4.1	—	U	2.6	5.6	—
B	—	4.2	—	V	2.7	5.7	—
C	—	4.3	—	X	2.8	5.8	2.85
D	—	4.4	—	Y	2.9	5.9	—
E	—	4.5	—	Z	3.0	6.0	—

④ Denotes the production lot number
0 to 9, A to Z repeated (G, I, J, O, Q, W excepted)

XC6203 Series

●TO-92

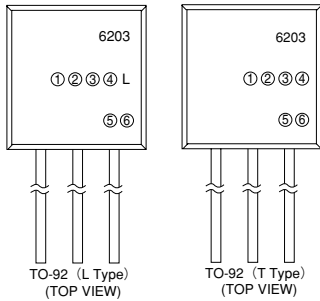

① Represents the type of regulator

DESIGNATOR	PRODUCT NAME
P	XC6203P*****
E	XC6203E*****

②③④ Represents the output voltage

DESIGNATOR			VOLTAGE (V)	VOLTAGE ACCURACY (%)	PRODUCT NAME
②	③	④			
3	3	2	3.3	±2	XC6203*33***
5	0	2	5.0	±2	XC6203*50***
2	8	A	2.85	±2	XC6203*28A**

⑤ Represents a least significant digit of the produced year

DESIGNATOR	PRODUCED YEAR
0	2000
1	2001

⑥ Denotes the production lot number
0 to 9, A to Z repeated (G, I, J, O, Q, W excepted)

Note: Character inversion is not used

■Block Diagram

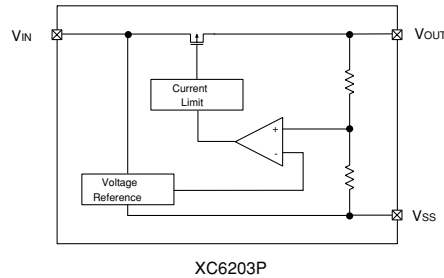
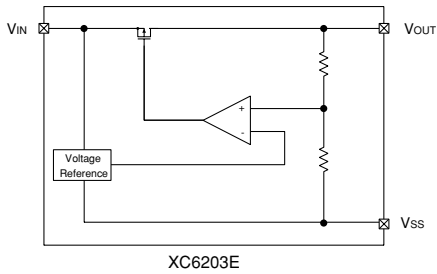

■Absolute Maximum Ratings

Ta=25°C

PARAMETER	SYMBOL	RATINGS	UNITS
Input Voltage	VIN	12	V
Output Current	IOUT	500	mA
Output Voltage	VOUT	VSS-0.3~VIN+0.3	V
Power Dissipation	SOT-89	500	mW
	SOT-223	1,200 (NOTE)	
	TO-92	300	
Operating Ambient Temperature	Topr	-40~+85	°C
Storage Temperature	Tstg	-40~+125	°C

Note: Circuits board mounting : Double-sided board

■ Electrical Characteristics

XC6203X182 $V_{OUT}(T)=1.8V$ (Note 1) Ta=25°C

PARAMETER	SYMBOL	CONDITIONS	MIN	TYP	MAX	UNITS
Output Voltage	$V_{OUT}(E)$ (Note2)	$V_{IN}=2.8V$ $I_{OUT}=40mA$	1.764	1.800	1.836	V
Maximum Output Current	I_{OUTmax}	$V_{IN}=2.8V$ $V_{OUT} \geq V_{OUT}(E) \times 0.90$	400			mA
Load Regulation	ΔV_{OUT}	$V_{IN}=2.8V$ $1mA \leq I_{OUT} \leq 200mA$		40	100	mV
Dropout Voltage (Note3)	V_{drl1}	$I_{OUT}=100mA$		200	300	mV
	V_{drl2}	$I_{OUT}=200mA$		400	600	
Supply Current	ISS	$V_{IN}=2.8V$		8.0	16.0	μA
Line Regulation	$\frac{\Delta V_{OUT}}{\Delta V_{IN} \cdot \Delta V_{OUT}}$	$I_{OUT}=40mA$ $2.8V \leq V_{IN} \leq 8.0V$		0.2	0.3	%/V
Input Voltage	V_{IN}				8	V
Output Voltage	$\frac{\Delta V_{OUT}}{\Delta T_{opr} \cdot V_{OUT}}$	$I_{OUT}=40mA$ $-40^{\circ}C \leq T_{opr} \leq 85^{\circ}C$		± 100		ppm /°C
Short Circuit Current (XC6203P Series Only)	I_{lim}	$V_{IN}=2.8V$ $V_{OUT}=0V$		60		mA

3

XC6203X252 $V_{OUT}(T)=2.5V$ (Note 1) Ta=25°C

PARAMETER	SYMBOL	CONDITIONS	MIN	TYP	MAX	UNITS
Output Voltage	$V_{OUT}(E)$ (Note2)	$V_{IN}=3.5V$ $I_{OUT}=40mA$	2.450	2.500	2.550	V
Maximum Output Current	I_{OUTmax}	$V_{IN}=3.5V$ $V_{OUT} > V_{OUT}(E) \times 0.93$	400			mA
Load Regulation	ΔV_{OUT}	$V_{IN}=3.5V$ $1mA \leq I_{OUT} \leq 200mA$		40	100	mV
Dropout Voltage (Note3)	V_{drl1}	$I_{OUT}=100mA$		170	250	mV
	V_{drl2}	$I_{OUT}=200mA$		320	500	
Supply Current	ISS	$V_{IN}=3.5V$		8.0	16.0	μA
Line Regulation	$\frac{\Delta V_{OUT}}{\Delta V_{IN} \cdot \Delta V_{OUT}}$	$I_{OUT}=40mA$ $3.5V \leq V_{IN} \leq 8.0V$		0.2	0.3	%/V
Input Voltage	V_{IN}				8	V
Output Voltage	$\frac{\Delta V_{OUT}}{\Delta T_{opr} \cdot V_{OUT}}$	$I_{OUT}=40mA$ $-40^{\circ}C \leq T_{opr} \leq 85^{\circ}C$		± 100		ppm /°C
Short Circuit Current (XC6203P Series Only)	I_{lim}	$V_{IN}=3.5V$ $V_{OUT}=0V$		60		mA

XC6203 Series

XC6203X302 $V_{OUT}(T)=3.0V$ (Note 1) $T_a=25^\circ C$

PARAMETER	SYMBOL	CONDITIONS	MIN	TYP	MAX	UNITS
Output Voltage	$V_{OUT}(E)$ (Note2)	$V_{IN}=4V$ $I_{OUT}=40mA$	2.940	3.000	3.060	V
Maximum Output Current	I_{OUTmax}	$V_{IN}=4V$ $V_{OUT} \geq V_{OUT}(E) \times 0.96$	400			mA
Load Regulation	ΔV_{OUT}	$V_{IN}=4V$ $1mA \leq I_{OUT} \leq 200mA$		40	100	mV
Dropout Voltage (Note3)	V_{dif1}	$I_{OUT}=100mA$		150	220	mV
	V_{dif2}	$I_{OUT}=200mA$		300	420	
Supply Current	I_{SS}	$V_{IN}=4V$		8.0	16.0	μA
Line Regulation	$\frac{\Delta V_{OUT}}{\Delta V_{IN} \cdot V_{OUT}}$	$I_{OUT}=40mA$ $4V \leq V_{IN} \leq 8.0V$		0.2	0.3	%/V
Input Voltage	V_{IN}				8	V
Output Voltage	$\frac{\Delta V_{OUT}}{\Delta T_{opr} \cdot V_{OUT}}$	$I_{OUT}=40mA$ $-40^\circ C \leq T_{opr} \leq 85^\circ C$		± 100		ppm /°C
Short Circuit Current (XC6203P Series Only)	I_{lim}	$V_{IN}=4V$ $V_{OUT}=0V$		60		mA

XC6203X332 $V_{OUT}(T)=3.3V$ (Note 1) $T_a=25^\circ C$

PARAMETER	SYMBOL	CONDITIONS	MIN	TYP	MAX	UNITS
Output Voltage	$V_{OUT}(E)$ (Note2)	$V_{IN}=4.3V$ $I_{OUT}=40mA$	3.234	3.300	3.366	V
Maximum Output Current	I_{OUTmax}	$V_{IN}=4.3V$ $V_{OUT} \geq V_{OUT}(E) \times 0.96$	400			mA
Load Regulation	ΔV_{OUT}	$V_{IN}=4.3V$ $1mA \leq I_{OUT} \leq 200mA$		40	100	mV
Dropout Voltage (Note3)	V_{dif1}	$I_{OUT}=100mA$		150	220	mV
	V_{dif2}	$I_{OUT}=200mA$		300	420	
Supply Current	I_{SS}	$V_{IN}=4.3V$		8.0	16.0	μA
Line Regulation	$\frac{\Delta V_{OUT}}{\Delta V_{IN} \cdot V_{OUT}}$	$I_{OUT}=40mA$ $4.3V \leq V_{IN} \leq 8.0V$		0.2	0.3	%/V
Input Voltage	V_{IN}				8	V
Output Voltage	$\frac{\Delta V_{OUT}}{\Delta T_{opr} \cdot V_{OUT}}$	$I_{OUT}=40mA$ $-40^\circ C \leq T_{opr} \leq 85^\circ C$		± 100		ppm /°C
Short Circuit Current (XC6203P Series Only)	I_{lim}	$V_{IN}=4.3V$ $V_{OUT}=0V$		60		mA

XC6203X502 $V_{OUT}(T)=5.0V$ (Note 1) $T_a=25^\circ C$

PARAMETER	SYMBOL	CONDITIONS	MIN	TYP	MAX	UNITS
Output Voltage	$V_{OUT}(E)$ (Note2)	$V_{IN}=6.0V$ $I_{OUT}=40mA$	4.900	5.000	5.100	V
Maximum Output Current	I_{OUTmax}	$V_{IN}=6.0V$ $V_{OUT} \geq V_{OUT}(E) \times 0.96$	400			mA
Load Regulation	ΔV_{OUT}	$V_{IN}=6.0V$ $1mA \leq I_{OUT} \leq 200mA$		40	100	mV
Dropout Voltage (Note3)	V_{drl1}	$I_{OUT}=100mA$		100	180	mV
	V_{drl2}	$I_{OUT}=200mA$		200	320	
Supply Current	I_{SS}	$V_{IN}=6.0V$		10.0	20.0	μA
Line Regulation	$\frac{\Delta V_{OUT}}{\Delta V_{IN} \cdot V_{OUT}}$	$I_{OUT}=40mA$ $6.0V \leq V_{IN} \leq 8.0V$		0.2	0.3	%V
Input Voltage	V_{IN}				8	V
Output Voltage Temperature Characteristics	$\frac{\Delta V_{OUT}}{\Delta T_{opr} \cdot V_{OUT}}$	$I_{OUT}=40mA$ $-40^\circ C \leq T_{opr} \leq 85^\circ C$		± 100		ppm $^\circ C$
Short Circuit Current (XC6203P Series Only)	I_{lim}	$V_{IN}=6.0V$ $V_{OUT}=0V$		60		mA

- Note : 1. $V_{OUT}(T)$ = Specified Output Voltage.
 2. $V_{OUT}(E)$ = Effective Output Voltage (i.e. the output voltage when " $V_{OUT}(T)+1.0V$ " is provided at the V_{IN} pin while maintaining a certain I_{OUT} value).
 3. $V_{drl} = V_{IN1} - V_{OUT1}$
 4. V_{OUT1} = A voltage equal to 98% of the output voltage when " $V_{OUT}(T)+1.0V$ " is input.e
 5. V_{IN1} = The input voltage when V_{OUT1} is output following a gradual decrease in the input voltage.

■ Typical Application Circuit

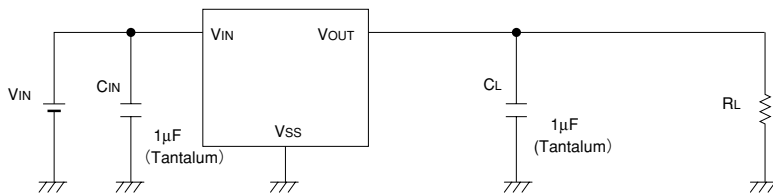

3

XC6203 Series

Typical Performance Characteristics

●XC6203E182PR

(1) OUTPUT VOLTAGE vs. OUTPUT CURRENT

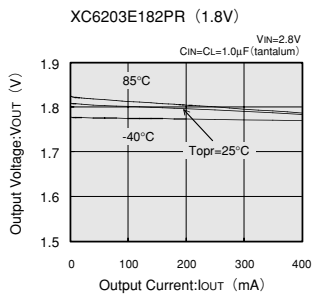

(2) OUTPUT VOLTAGE vs. INPUT VOLTAGE

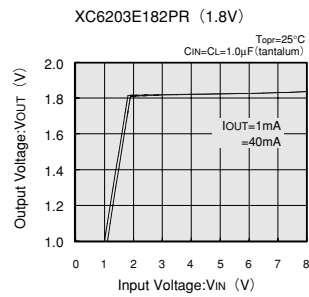

(3) DROPOUT VOLTAGE vs. OUTPUT CURRENT

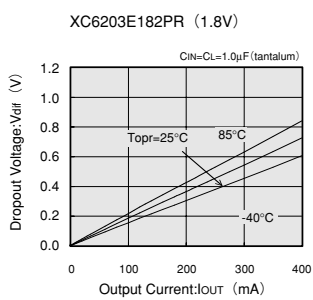

(4) SUPPLY CURRENT vs. INPUT VOLTAGE

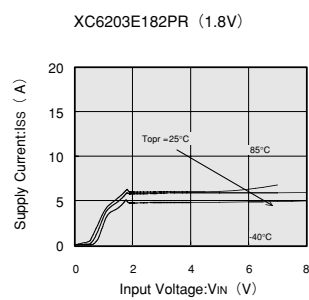

(5) OUTPUT VOLTAGE vs. AMBIENT TEMPERATURE

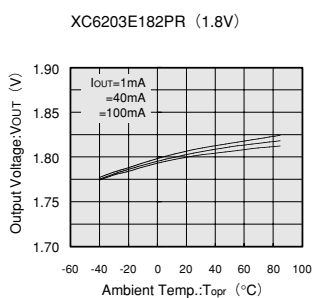

(6) SUPPLY CURRENT vs. AMBIENT TEMPERATURE

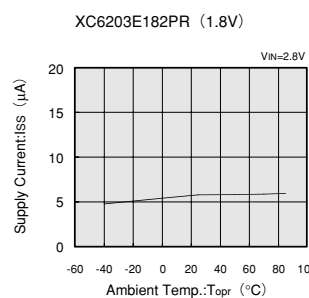

(7) INPUT TRANSIENT RESPONSE

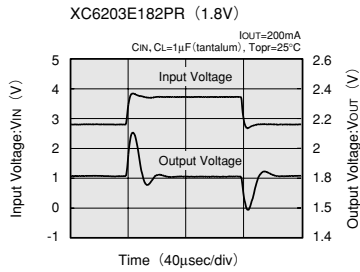

3

(8) LOAD TRANSIENT RESPONSE

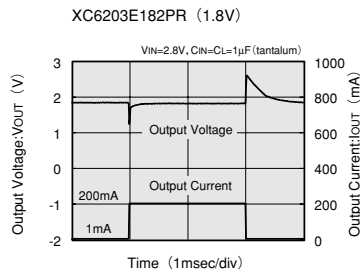
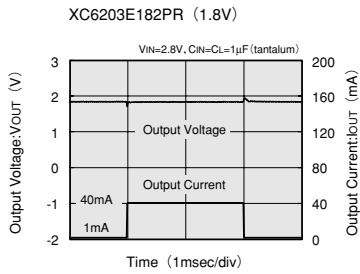

(9) RIPPLE REJECTION RATE

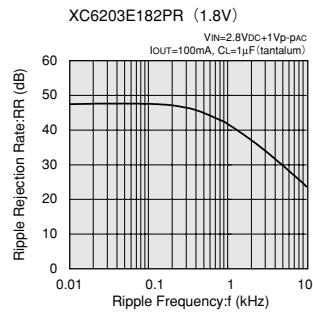
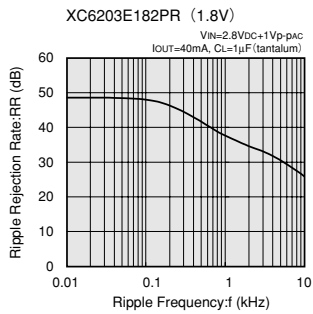

XC6203 Series

●XC6203E252PR

(1) OUTPUT VOLTAGE vs. OUTPUT CURRENT

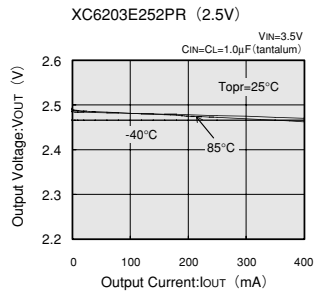

(2) OUTPUT VOLTAGE vs. INPUT VOLTAGE

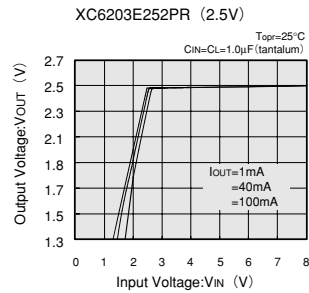

(3) DROPOUT VOLTAGE vs. OUTPUT CURRENT

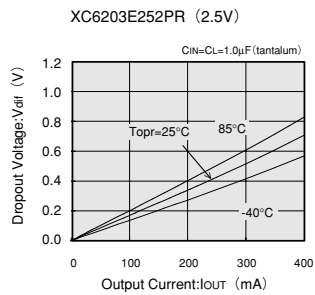

(4) SUPPLY CURRENT vs. INPUT VOLTAGE

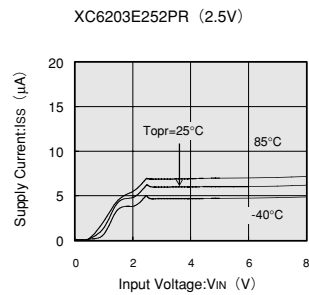

(5) OUTPUT VOLTAGE vs. AMBIENT TEMPERATURE

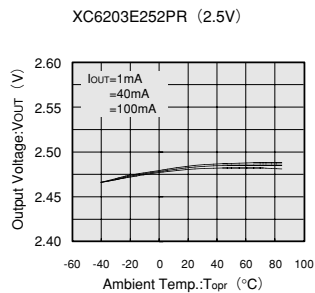

(6) SUPPLY CURRENT vs. AMBIENT TEMPERATURE

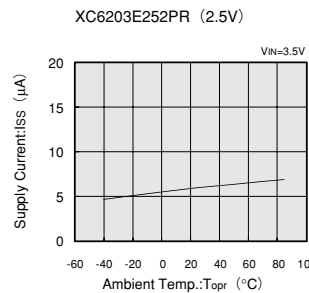

(7) INPUT TRANSIENT RESPONSE

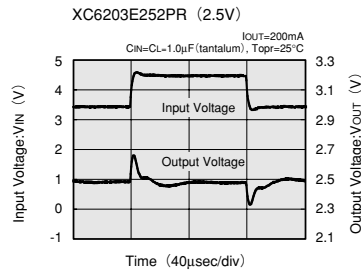
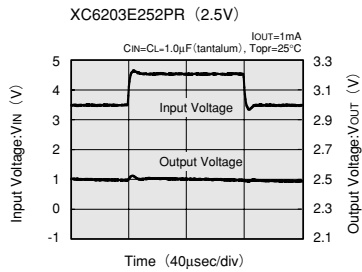

3

(8) LOAD TRANSIENT RESPONSE

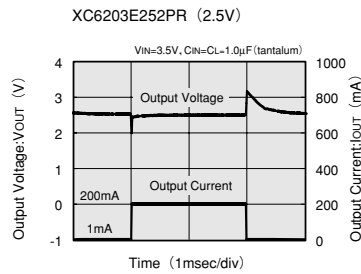
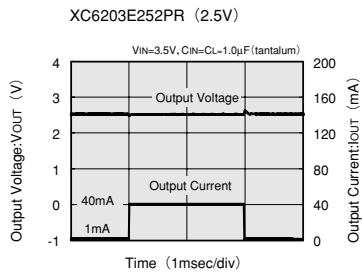

(9) RIPPLE REJECTION RATE

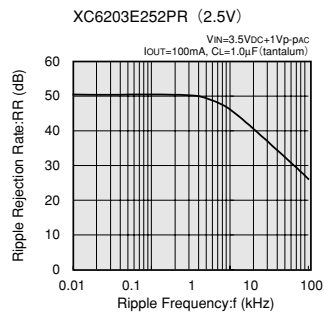
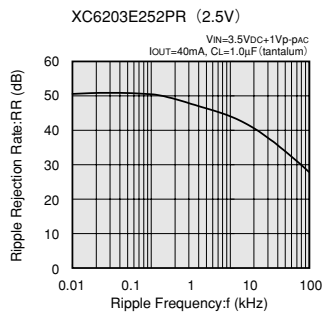

XC6203 Series

●XC6203E332PR

(1) OUTPUT VOLTAGE vs. OUTPUT CURRENT

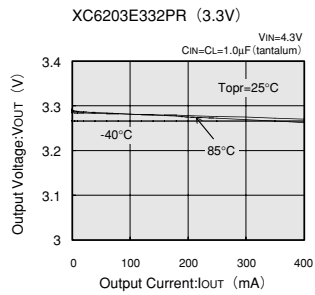

(2) OUTPUT VOLTAGE vs. INPUT VOLTAGE

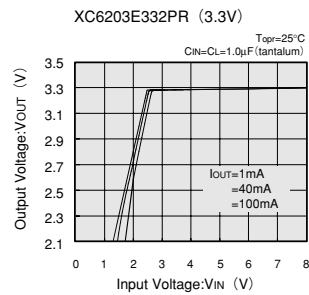

(3) DROPOUT VOLTAGE vs. OUTPUT CURRENT

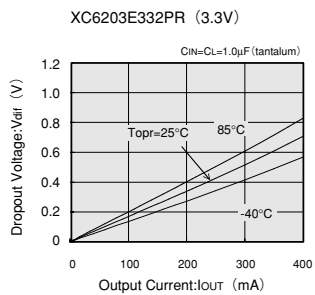

(4) SUPPLY CURRENT vs. INPUT VOLTAGE

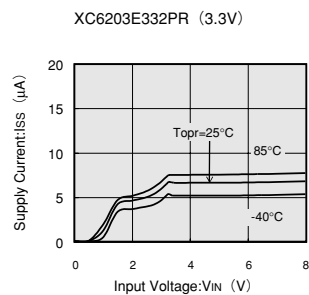

(5) OUTPUT VOLTAGE vs. AMBIENT TEMPERATURE

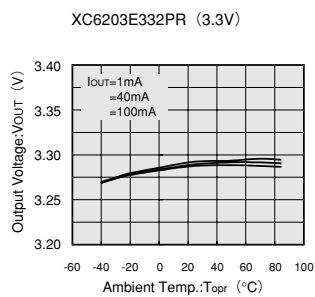

(6) SUPPLY CURRENT vs. AMBIENT TEMPERATURE

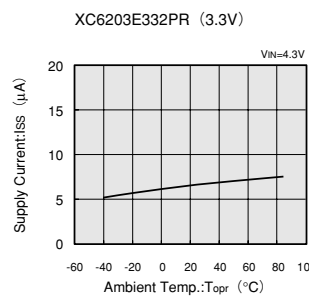

(7) INPUT TRANSIENT RESPONSE

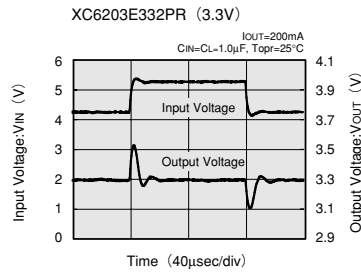
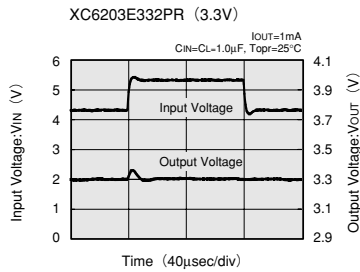

3

(8) LOAD TRANSIENT RESPONSE

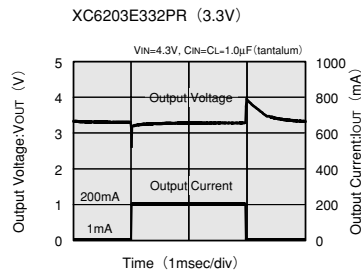
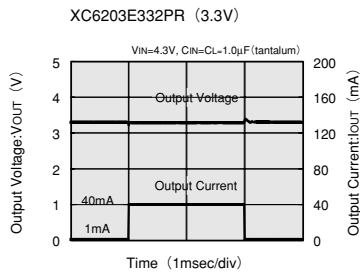

(9) RIPPLE REJECTION RATE

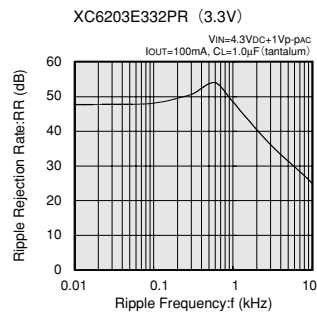
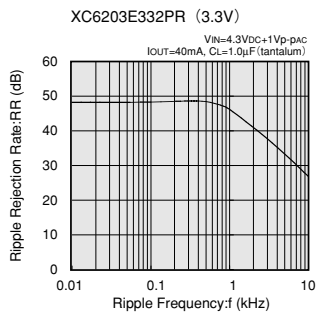

XC6203 Series

●XC6203E502PR

(1) OUTPUT VOLTAGE vs. OUTPUT CURRENT

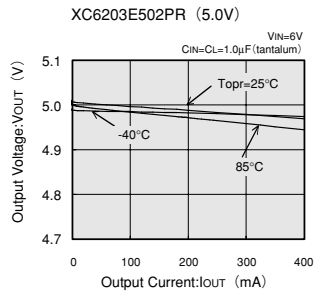

(2) OUTPUT VOLTAGE vs. INPUT VOLTAGE

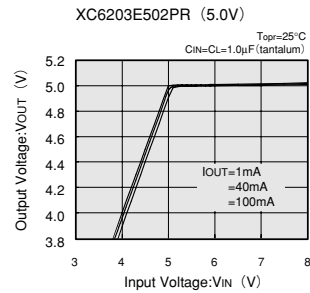

(3) DROPOUT VOLTAGE vs. OUTPUT CURRENT

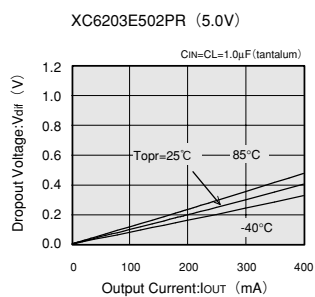

(4) SUPPLY CURRENT vs. INPUT VOLTAGE

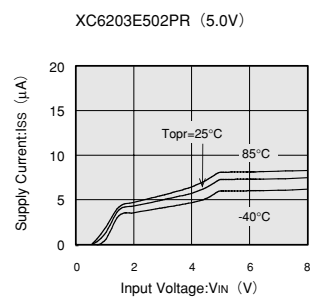

(5) OUTPUT VOLTAGE vs. AMBIENT TEMPERATURE

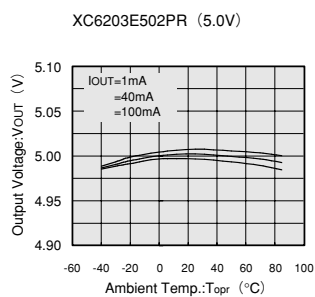

(6) SUPPLY CURRENT vs. AMBIENT TEMPERATURE

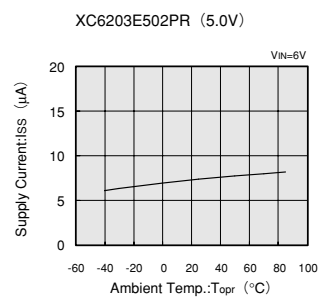

(7) INPUT TRANSIENT RESPONSE

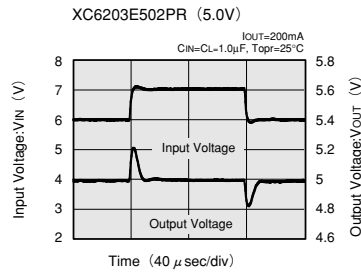
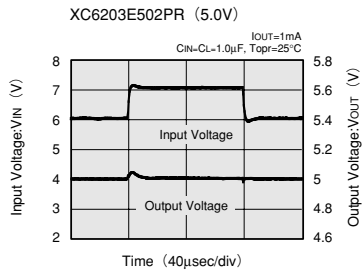

3

(8) LOAD TRANSIENT RESPONSE

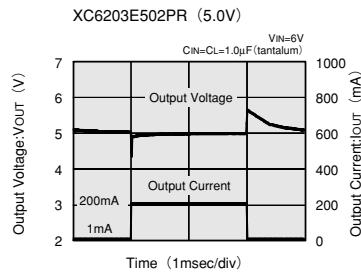
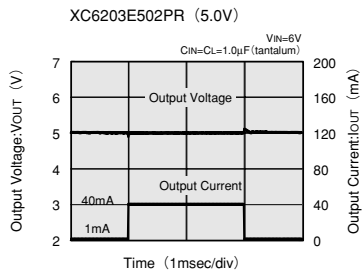

(9) RIPPLE REJECTION RATE

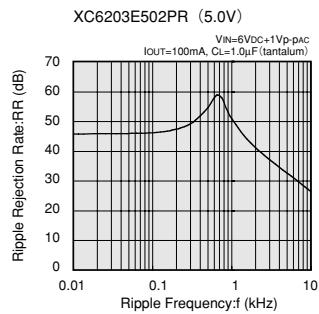
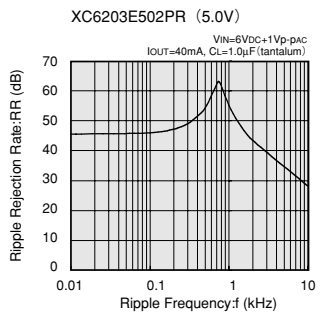

XC6203 Series

(10) OUTPUT VOLTAGE vs. OUTPUT CURRENT

