

JFW050H, JFW075H, JFW100H, JFW150H Power Modules: dc-dc Converters; 36 to 75 Vdc Input, 24 Vdc Output; 50 W to 150 W

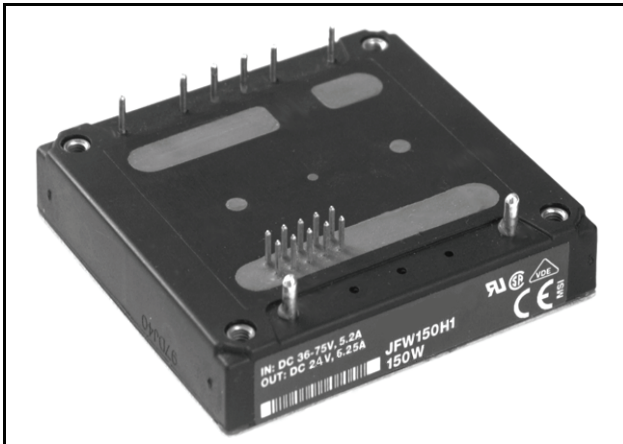

The JFW-Series Power Modules use advanced, surface-mount technology and deliver high-quality, efficient, compact dc-dc conversion.

Applications

- Redundant and/or distributed power architectures
- Workstations
- Computer equipment
- Communications equipment

Options

- Heat sinks available for extended operation
- Choice of primary remote on/off logic configuration
- Delayed current-limit shutdown

Description

The JFW-Series Power Modules are dc-dc converters that operate over an input voltage range of 36 Vdc to 75 Vdc and provide a precisely regulated dc output. The output is fully isolated from the input, allowing versatile polarity configurations and grounding connections. The modules have maximum power ratings from 50 W to 150 W at typical full-load efficiencies of 89%.

The sealed modules have metal baseplates for excellent thermal performance. Threaded-through holes are provided for easy mounting or adding a heat sink for high-temperature applications. Listed above are the enhanced features for convenience and flexibility in

redundant and/or distributed power applications.

Features

- Small size: 61.0 mm x 57.9 mm x 12.7 mm (2.40 in. x 2.28 in. x 0.50 in.)
- High power density
- High efficiency: 89% typical
- Low output noise
- Constant frequency
- Metal baseplate
- 2:1 input voltage range
- Anti-rollback circuit
- Overcurrent protection
- Current-limit set-point adjustment
- Primary and secondary remote on/off
- Remote sense
- Adjustable output voltage: 60% to 110% of $V_{O, nom}$
- Output overvoltage protection
- Overvoltage set-point adjustment
- Synchronization
- Forced load sharing (parallelable)
- Parallelable with FW300H1
- Output current monitor
- Overtemperature protection
- Power good signal
- Thermal warning signal
- Case ground pin
- ISO* 9001 Certified manufacturing facilities
- UL†1950 Recognized, CSA‡ C22.2 No. 950-95 Certified, and VDE§ 0805 (EN60950, IEC950) Licensed
- CE mark meets 73/23/EEC and 93/68/EEC directives**

* ISO is a registered trademark of the International Organization for Standardization.

† UL is a registered trademark of Underwriters Laboratories, Inc.

‡ CSA is a registered trademark of Canadian Standards Assn.

§ VDE is a trademark of Verband Deutscher Elektrotechniker e.V.

** This product is intended for integration into end-use equipment.

Absolute Maximum Ratings

Stresses in excess of the absolute maximum ratings can cause permanent damage to the device. These are absolute stress ratings only. Functional operation of the device is not implied at these or any other conditions in excess of those given in the operations sections of the data sheet. Exposure to absolute maximum ratings for extended periods can adversely affect device reliability.

Parameter	Symbol	Min	Max	Unit
Input Voltage: Continuous: JFW050H, JFW075H JFW100H, JFW150H Transient (100 ms; JFW100H, JFW150H only)	V_i V_i $V_{i, trans}$	— — —	75 80 100	Vdc Vdc V
I/O Isolation Voltage (for 1 minute)	—	—	1500	Vdc
Operating Case Temperature (See Thermal Considerations section.)	T_c	-40	100	°C
Storage Temperature	T_{stg}	-55	125	°C

Electrical Specifications

Unless otherwise indicated, specifications apply over all operating input voltage, resistive load, and temperature conditions.

Table 1. Input Specifications

Parameter	Symbol	Min	Typ	Max	Unit
Operating Input Voltage	V_i	36	48	75	Vdc
Maximum Input Current ($V_i = 0$ V to 75 V; $I_o = I_{o, max}$; see Figures 1—4.): JFW050H JFW075H JFW100H JFW150H	$I_{i, max}$ $I_{i, max}$ $I_{i, max}$ $I_{i, max}$	— — — —	— — — —	2.2 3.3 4.4 6.8	A A A A
Maximum Input Current ($V_i = 36$ V to 75 V; $I_o = I_{o, max}$; see Figures 1—4.): JFW050H JFW075H JFW100H JFW150H	$I_{i, max}$ $I_{i, max}$ $I_{i, max}$ $I_{i, max}$	— — — —	— — — —	1.7 2.55 3.4 5.2	A A A A
Inrush Transient	i^2t	—	—	1.0	A ² s
Input Reflected-ripple Current, Peak-to-peak (5 Hz to 20 MHz, 12 μ H source impedance; see Figure 17.)	I_i	—	5	—	mAp-p
Input Ripple Rejection (120 Hz)	—	—	60	—	dB

Fusing Considerations

CAUTION: This power module is not internally fused. An input line fuse must always be used.

This encapsulated power module can be used in a wide variety of applications, ranging from simple stand-alone operation to an integrated part of a sophisticated power architecture. To preserve maximum flexibility, internal fusing is not included; however, to achieve maximum safety and system protection, always use an input line fuse. The safety agencies require a normal-blow fuse with a maximum rating of 20 A (see Safety Considerations section). Based on the information provided in this data sheet on inrush energy and maximum dc input current, the same type of fuse with a lower rating can be used. Refer to the fuse manufacturer's data for further information.

Electrical Specifications (continued)

Table 2. Output Specifications

Parameter	Device	Symbol	Min	Typ	Max	Unit
Output Voltage Set Point ($V_I = 48\text{ V}$; $I_O = I_{O, \max}$; $T_C = 25\text{ }^\circ\text{C}$)	All	$V_{O, \text{set}}$	23.55	24.0	24.45	Vdc
Output Voltage (Over all operating input voltage, static resistive load, and temperature conditions until end of life; see Figure 19.)	All	V_O	23.28	—	24.72	Vdc
Output Regulation:						
Line ($V_I = 36\text{ V to } 75\text{ V}$)	All	—	—	0.01	0.1	% V_O
Load ($I_O = I_{O, \min}$ to $I_{O, \max}$)	All	—	—	0.05	0.2	% V_O
Temperature ($T_C = -40\text{ }^\circ\text{C to } +100\text{ }^\circ\text{C}$)	All	—	—	100	300	mV
Output Ripple and Noise Voltage (See Figure 18.):						
RMS	All	—	—	—	150	mVrms
Peak-to-peak (5 Hz to 20 MHz)	All	—	—	—	400	mVp-p
External Load Capacitance	All	—	0	—	*	μF
Output Current (At $I_O < I_{O, \min}$, the module may exceed output ripple specifications.)	JFW050H JFW075H JFW100H JFW150H	I_O	0.3 0.3 0.3 0.3	— — — —	2.1 3.1 4.2 6.2	A A A A
Output Current-limit Inception (untrimmed; $V_O = 90\%$ of $V_{O, \text{nom}}$)	JFW050H JFW075H JFW100H JFW150H	$I_{O, \text{cli}}$	— — — —	2.4 3.6 4.8 7.3	2.7 [†] 4.0 [†] 5.5 [†] 8.1 [†]	A A A A
Output Short-circuit Current ($V_O = 250\text{ mV}$)	All	—	—	170	—	% $I_{O, \max}$
Efficiency ($V_I = 48\text{ V}$; $I_O = I_{O, \max}$; $T_C = 70\text{ }^\circ\text{C}$; see Figures 9—12 and 19.)	JFW050H JFW075H JFW100H JFW150H	η	— — — —	87 88 89 89	— — — —	% % % %
Switching frequency	All	—	—	500	—	kHz
Dynamic Response ($\Delta I_O / \Delta t = 1\text{ A}/10\text{ } \mu\text{s}$, $V_I = 48\text{ V}$, $T_C = 25\text{ }^\circ\text{C}$; tested with a $10\text{ } \mu\text{F}$ aluminum and a $1.0\text{ } \mu\text{F}$ ceramic capacitor across the load; see Figures 14 and 15.):						
Load Change from $I_O = 50\%$ to 75% of $I_{O, \max}$:						
Peak Deviation	All	—	—	3	—	% $V_{O, \text{set}}$
Settling Time ($V_O < 10\%$ of peak deviation)	All	—	—	300	—	μs
Load Change from $I_O = 50\%$ to 25% of $I_{O, \max}$:						
Peak Deviation	All	—	—	3	—	% $V_{O, \text{set}}$
Settling Time ($V_O < 10\%$ of peak deviation)	All	—	—	300	—	μs

* Consult your sales representative or the factory.

† These are manufacturing test limits. In some situations, results may differ.

Table 3. Isolation Specifications

Parameter	Min	Typ	Max	Unit
Isolation Capacitance	—	2500	—	pF
Isolation Resistance	10	—	—	M Ω

General Specifications

Parameter	Min	Typ	Max	Unit
Calculated MTBF ($I_o = 80\%$ of $I_{o, max}$; $T_c = 40\text{ }^\circ\text{C}$)		2,300,000		hr
Weight	—	—	100 (3.5)	g (oz.)

Feature Specifications

Unless otherwise indicated, specifications apply over all operating input voltage, resistive load, and temperature conditions. See Feature Descriptions and Design Considerations sections for further information.

Table 4. Feature Specifications

Parameter	Symbol	Min	Typ	Max	Unit
Remote On/Off Signal Interface ($V_i = 0\text{ V}$ to 75 V ; open collector or equivalent compatible; signal referenced to $V_i(-)$ terminal; see Figure 20 and Feature Descriptions.): JFWxxxH1 Preferred Logic: Both Primary and Secondary Referenced Remote On/Off: Logic Low—Module On Logic High—Module Off JFWxxxH Optional Logic (optional for primary referenced remote on/off only): Primary Referenced Remote On/Off: Logic Low—Module Off Logic High—Module On Secondary Referenced Remote On/Off: Logic Low—Module On Logic High—Module Off Logic Low: $I_{on/off} = 1.0\text{ mA}$ $V_{on/off} = 0.0\text{ V}$ Logic High (open collector): $I_{on/off} = 0.0\text{ }\mu\text{A}$ Leakage Current Turn-on Time ($I_o = 80\%$ of $I_{o, max}$; V_o within $\pm 1\%$ of steady state. See Figure 16.)	$V_{on/off}$ $I_{on/off}$ $V_{on/off}$ $I_{on/off}$ —	0 — — — —	— — — 20	1.2 1.0 15 50 35	V mA V μA ms
Forced Load Sharing	—	*	10	*	% I_o , rated
Output Voltage Adjustment (See Feature Descriptions.): Output Voltage Remote-sense Range Output Voltage Set-point Adjustment (trim) Range	— —	— 60	— —	0.5 110	V % $V_{o, nom}$
Output Overvoltage Protection	—	26.5*	—	33.0*	V
Overvoltage Set-Point Adjustment Range	—	50	—	100	% $V_{o, clamp, nom}$
Synchronization: Clock Amplitude Clock Pulse Width Fan-out Capture Frequency Range	— — — —	4.00 0.4 — 425	— — — —	5.00 — 1 575	V μs — kHz

* These are manufacturing test limits. In some situations, results may differ.

Feature Specifications (continued)

Table 4. Feature Specifications (continued)

Parameter	Symbol	Min	Typ	Max	Unit
Output Current Monitor ($I_o = I_{o, \max}$, $T_c = 70^\circ\text{C}$):					
JFW050H	$I_{o, \text{mon}}$	—	1.55	—	V/A
JFW075H	$I_{o, \text{mon}}$	—	1.00	—	V/A
JFW100H	$I_{o, \text{mon}}$	—	0.738	—	V/A
JFW150H	$I_{o, \text{mon}}$	—	0.50	—	V/A
Overtemperature Protection (See Figure 27.)	T_c	—	105	—	$^\circ\text{C}$
Power Good Signal (Open collector output; low level indicates power good.):					
Output Sink Current ($V_o \delta 1.5\text{ V}$)	—	—	—	50	mA
Maximum Voltage	—	—	—	36	V
High-state Internal Impedance to Ground	—	—	200	—	$k\Omega$
Thermal Warning Signal (Open collector output; low level indicates overtemperature shutdown is imminent.):					
Output Sink Current ($V_o \delta 1.5\text{ V}$)	—	—	—	6	mA
Maximum Voltage	—	—	—	36	V
High-state Internal Impedance to Ground	—	—	200	—	$k\Omega$
Current-Limit Set-Point Adjustment Range	—	10	—	100	$\%I_{o, \text{cli, nom}}$
Overcurrent Shutdown Delay (optional)	—	—	4	—	s

Solder, Cleaning, and Drying Considerations

Post solder cleaning is usually the final circuit-board assembly process prior to electrical testing. The result of inadequate circuit-board cleaning and drying can affect both the reliability of a power module and the testability of the finished circuit-board assembly. For guidance on appropriate soldering, cleaning, and drying procedures, refer to the *Board-Mounted Power Modules Soldering and Cleaning* Application Note (AP97-021EPS).

Characteristic Curves

The following figures provide typical characteristics for the power modules. The figures are applicable to both on/off configurations.

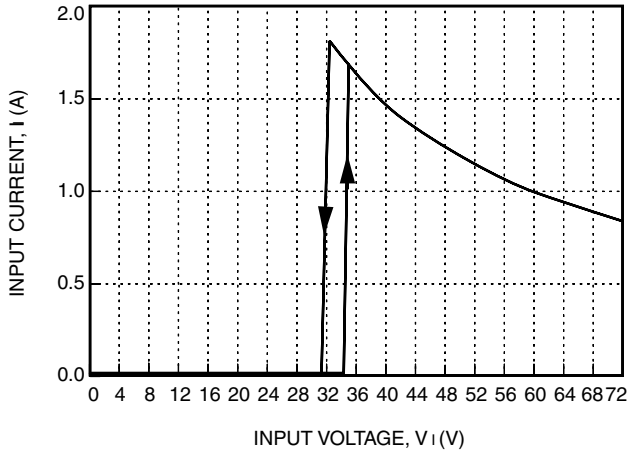

8-1159 (C)

Figure 1. Typical JFW050H Input Characteristics at Room Temperature, $I_o = I_o, \max$

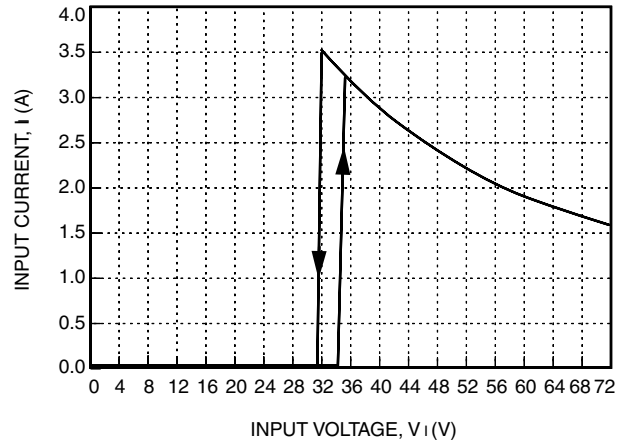

8-1160 (C)

Figure 3. Typical JFW100H Input Characteristics at Room Temperature, $I_o = I_o, \max$

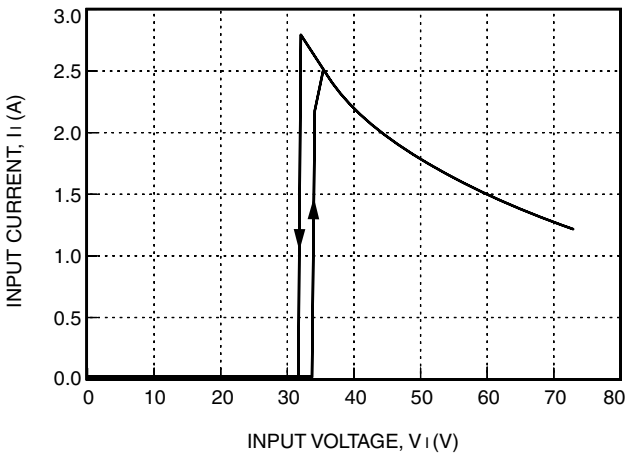

8-1131 (C)

Figure 2. Typical JFW075H Input Characteristics at Room Temperature, $I_o = I_o, \max$

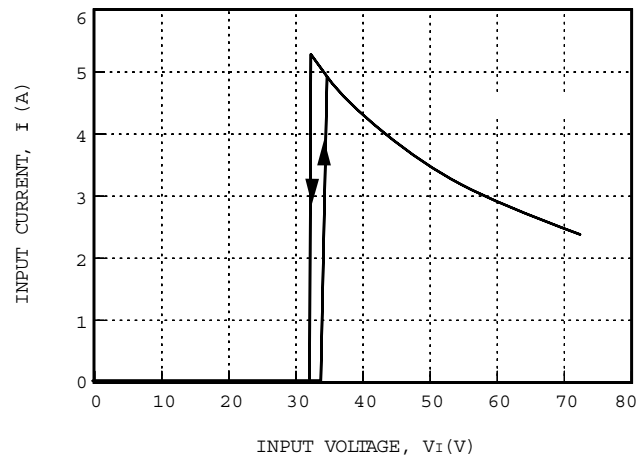

8-1142 (C)

Figure 4. Typical JFW150H Input Characteristics at Room Temperature, $I_o = I_o, \max$

Characteristic Curves (continued)

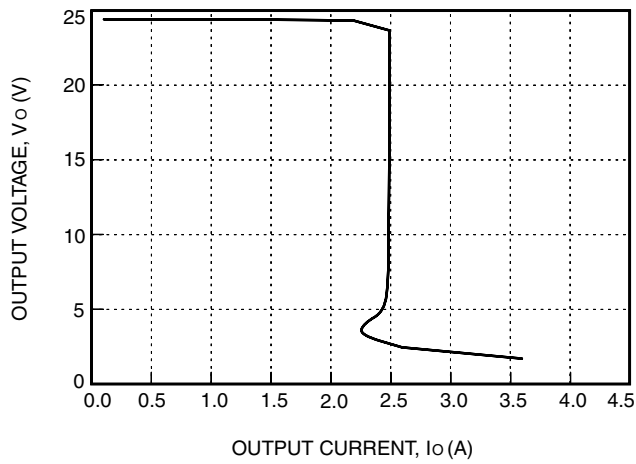

8-1286 (C)

Figure 5. Typical JFW050H Output Characteristics at Room Temperature, $V_i = 48\text{ V}$

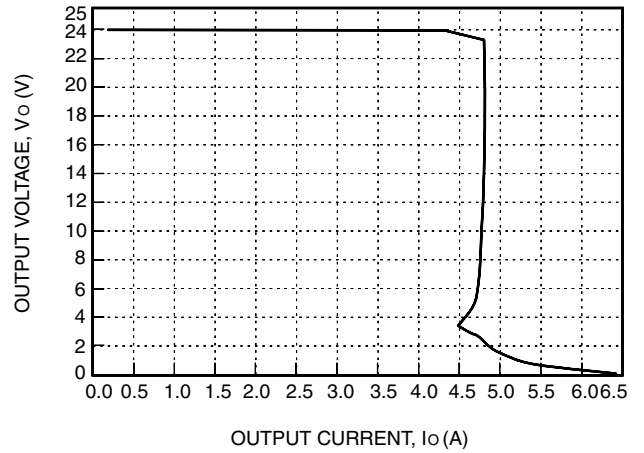

8-1288 (C)

Figure 7. Typical JFW100H Output Characteristics at Room Temperature, $V_i = 48\text{ V}$

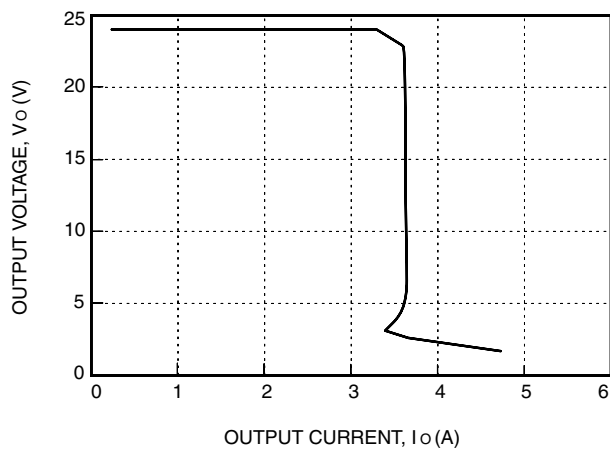

8-1287 (C)

Figure 6. Typical JFW075H Output Characteristics at Room Temperature, $V_i = 48\text{ V}$

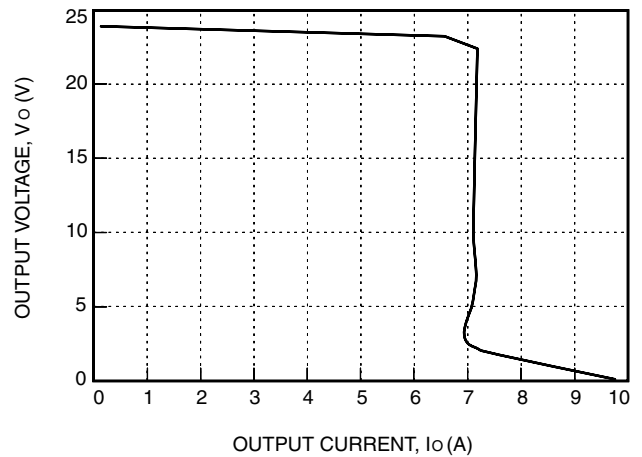

8-1289 (C)

Figure 8. Typical JFW150H Output Characteristics at Room Temperature, $V_i = 48\text{ V}$

Characteristic Curves (continued)

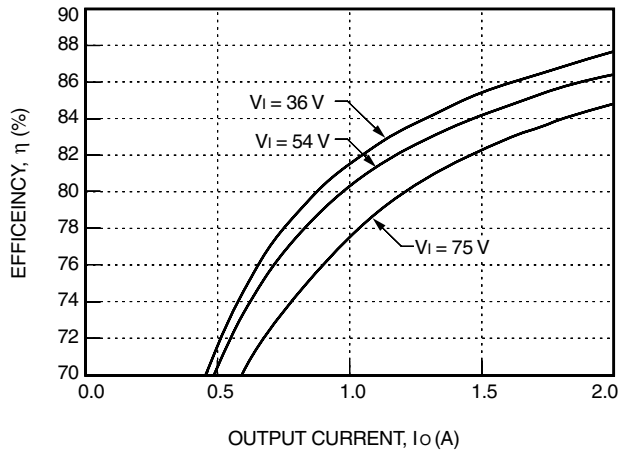

8-1290(C)

Figure 9. Typical JFW050H Converter Efficiency vs. Output Current at Room Temperature

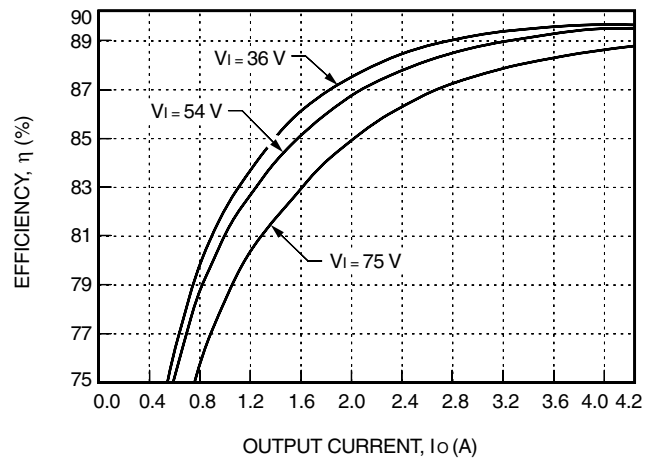

8-1292 (C)

Figure 11. Typical JFW100H Converter Efficiency vs. Output Current at Room Temperature

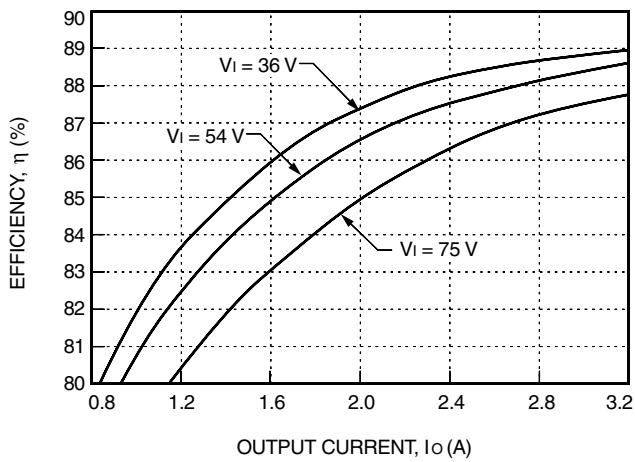

8-1291 (C)

Figure 10. Typical JFW075H Converter Efficiency vs. Output Current at Room Temperature

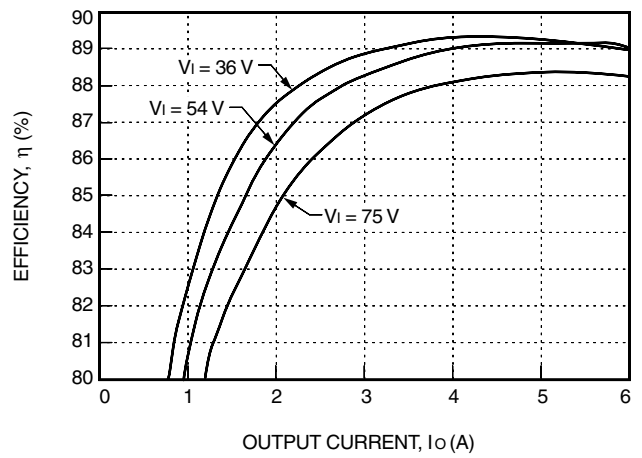

8-1293 (C)

Figure 12. Typical JFW150H Converter Efficiency vs. Output Current at Room Temperature

Characteristic Curves (continued)

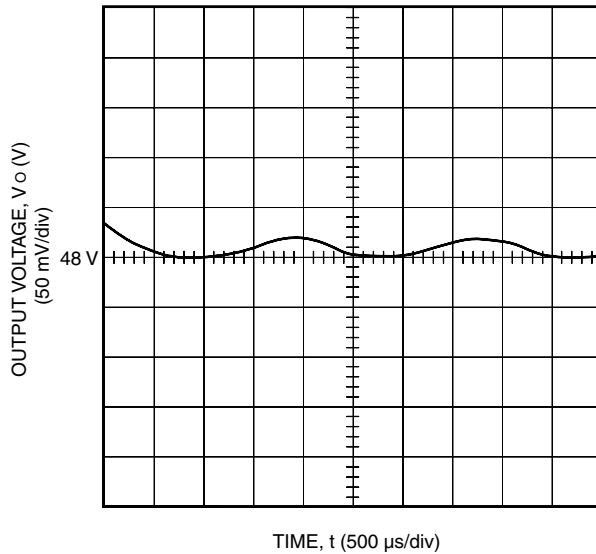

8-2008 (C)

Note: See Figure 18 for test conditions.

Figure 13. Typical JFW150H Output Ripple Voltage at Room Temperature, 48 V Input, $I_o = I_o, \text{max}$

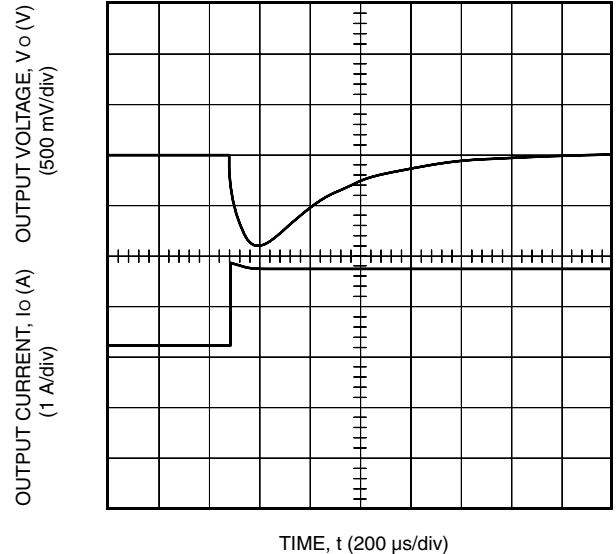

8-2010 (C)

Note: Tested with a 10 μF aluminum and a 1.0 μF ceramic capacitor across the load.

Figure 15. Typical JFW150H Transient Response to Step Increase in Load from 50% to 75% of Full Load at Room Temperature and 48 V Input (Waveform Averaged to Eliminate Ripple Component.)

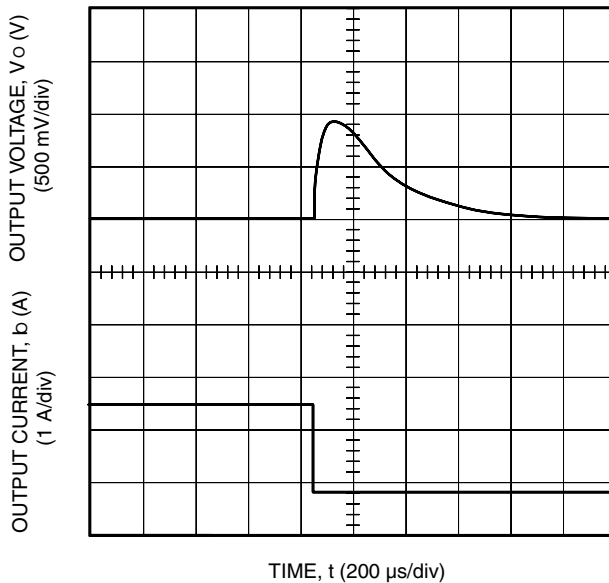

8-2009 (C)

Note: Tested with a 10 μF aluminum and a 1.0 μF ceramic capacitor across the load.

Figure 14. Typical JFW150H Transient Response to Step Decrease in Load from 50% to 25% of Full Load at Room Temperature and 48 V Input (Waveform Averaged to Eliminate Ripple Component.)

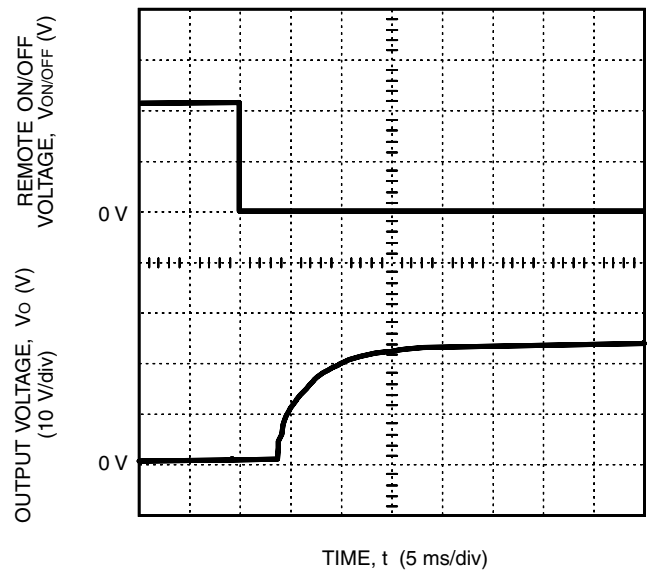

8-1266 (C).c

Note: Tested with a 10 μF aluminum and a 1.0 μF ceramic capacitor across the load.

Figure 16. Typical Start-Up from Remote On/Off JFW150H1; $I_o = I_o, \text{max}$

Test Configurations

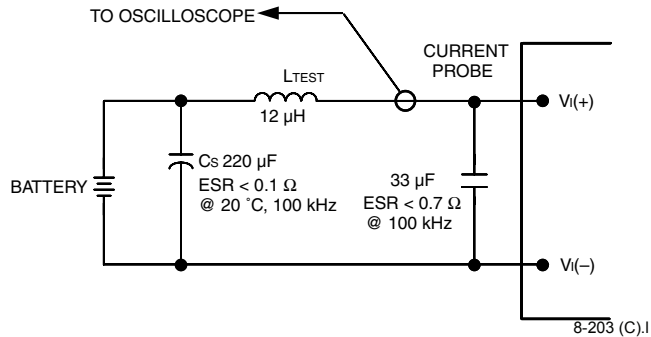

Note: Measure input reflected-ripple current with a simulated source inductance (L_{TEST}) of 12 μ H. Capacitor C_s offsets possible battery impedance. Measure current as shown above.

Figure 17. Input Reflected-Ripple Test Setup

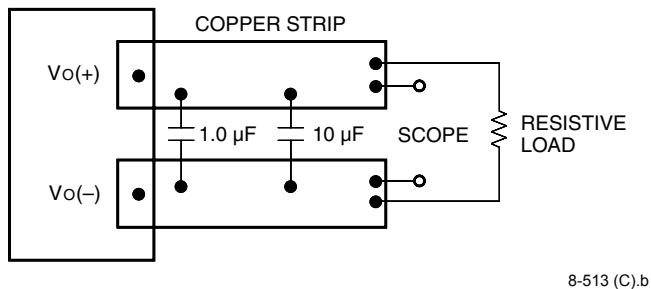

Note: Use a 1.0 μ F ceramic capacitor and a 10 μ F aluminum or tantalum capacitor. Scope measurement should be made using a BNC socket. Position the load between 51 mm and 76 mm (2 in. and 3 in.) from the module.

Figure 18. Peak-to-Peak Output Noise Measurement Test Setup

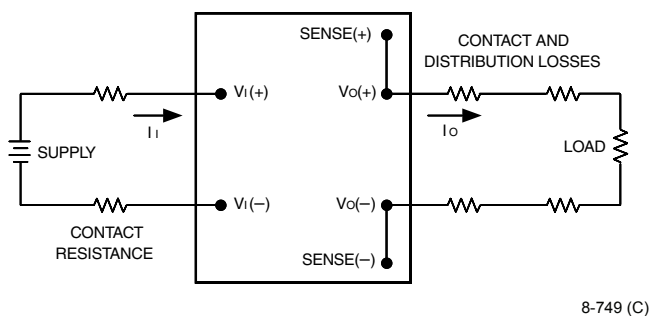

Note: All measurements are taken at the module terminals. When socketing, place Kelvin connections at module terminals to avoid measurement errors due to socket contact resistance.

$$\eta = \left(\frac{[V_o(+)] - [V_o(-)]}{[V_i(+)] - [V_i(-)]} \right) \frac{I_o}{I_i} \times 100 \quad \%$$

Figure 19. Output Voltage and Efficiency Measurement Test Setup

Design Considerations

Input Source Impedance

The power module should be connected to a low ac-impedance input source. Highly inductive source impedances can affect the stability of the power module. For the test configuration in Figure 17, a 33 μ F electrolytic capacitor (ESR < 0.7 Ω at 100 kHz) mounted close to the power module helps ensure stability of the unit. For other highly inductive source impedances, consult the factory for further application guidelines.

Safety Considerations

For safety-agency approval of the system in which the power module is used, the power module must be installed in compliance with the spacing and separation requirements of the end-use safety agency standard, i.e., UL1950, CSA C22.2 No. 950-95, and VDE 0805 (EN60950, IEC950).

If the input source is non-SELV (ELV or a hazardous voltage greater than 60 Vdc and less than or equal to 75 Vdc), for the module's output to be considered meeting the requirements of safety extra-low voltage (SELV), all of the following must be true:

- n The input source is to be provided with reinforced insulation from any hazardous voltages, including the ac mains.
- n One V_i pin and one V_o pin are to be grounded or both the input and output pins are to be kept floating.
- n The input pins of the module are not operator accessible.
- n Another SELV reliability test is conducted on the whole system, as required by the safety agencies, on the combination of supply source and the subject module to verify that under a single fault, hazardous voltages do not appear at the module's output.

Note: Do not ground either of the input pins of the module without grounding one of the output pins. This may allow a non-SELV voltage to appear between the output pin and ground.

The power module has extra-low voltage (ELV) outputs when all inputs are ELV.

The input to these units is to be provided with a maximum 20 A normal-blow fuse in the ungrounded lead.

Feature Descriptions

Overcurrent Protection

To provide protection in a fault (output overload) condition, the unit is equipped with internal current-limiting circuitry and optional delayed shutdown. At the point of current-limit inception, the unit shifts from voltage control to current control. If the output voltage is pulled very low during a severe fault, the current-limit circuit can exhibit either foldback or tailout characteristics (output current decrease or increase). The unit will operate normally once the output current is brought back into its specified range. If the module has the optional delayed current-limit shutdown, the unit will operate normally once the output current is brought back to its specified range, provided the overcurrent condition is removed before the module shuts down.

The current-limit set point can be reduced by connecting a resistor between the overcurrent trim (OCTRIM) pin and SENSE(-) pin. The resistor value is derived by the following equation:

$$R_{cl-adj} = \left(\frac{11 I_{trim} - 1.15 I_{rated}}{1.15 I_{rated} - I_{trim}} \right) k\Omega$$

Where:

R_{cl-adj} is the value of an external resistor between the OCTRIM pin and SENSE(-) pin.

I_{rated} is the output current rating of the module (not the output current-limit inception).

I_{trim} is the trimmed value of the output current-limit set point.

Remote On/Off

There are two remote on/off signals, a primary referenced signal and a secondary referenced signal. Both signals must be asserted on for the module to deliver output power. If either signal is asserted off, the module will not deliver output power. Both signals have internal pull-up circuits and are designed to interface with an open collector pull-down device. Typically, one on/off signal will be permanently enabled by hardwiring it to its return while the other on/off signal is used exclusively for control.

Primary Remote On/Off

The primary remote on/off signal (ON/OFF) is available with either positive or negative logic. Positive logic turns the module on during a logic high and off during a logic low. Negative logic remote on/off turns the module off

during a logic high and on during a logic low. Negative logic (code suffix 1) is the factory-preferred configuration.

To turn the power module on and off, the user must supply a switch to control the voltage between the primary remote on/off terminal ($V_{on/off, pri}$) and the $V_I(-)$ terminal. The switch can be an open collector or equivalent (see Figure 20). A logic low is $V_{on/off, pri} = 0$ V to 1.2 V. The maximum $I_{on/off, pri}$ during a logic low is 1 mA. The switch should maintain a logic-low voltage while sinking 1 mA.

During a logic high, the maximum $V_{on/off, pri}$ generated by the power module is 15 V. The maximum allowable leakage current of the switch at $V_{on/off, pri} = 15$ V is 50 μ A.

If not using the primary remote on/off feature, do one of the following:

- For negative logic, short the ON/OFF pin to $V_I(-)$.
- For positive logic, leave the ON/OFF pin open.

Secondary Remote On/Off

The secondary remote on/off signal (S-ON/OFF pin) is only available with negative logic. The negative logic signal turns the module off during a logic high and on during a logic low. To turn the power module on and off, the user must supply a switch to control the voltage between the S-ON/OFF pin and the SENSE(-) pin ($V_{on/off, sec}$). The switch can be an open collector or equivalent (see Figure 20). A logic low is $V_{on/off, sec} = 0$ V to 1.2 V. The maximum $I_{on/off, sec}$ during a logic low is 1 mA. The switch should maintain a logic-low voltage while sinking 1 mA.

During a logic high, the maximum $V_{on/off, sec}$ generated by the power module is 15 V. The maximum allowable leakage current of the switch at $V_{on/off, sec} = 15$ V is 50 μ A.

If not using the secondary remote on/off feature, short the S-ON/OFF pin to the SENSE(-) pin.

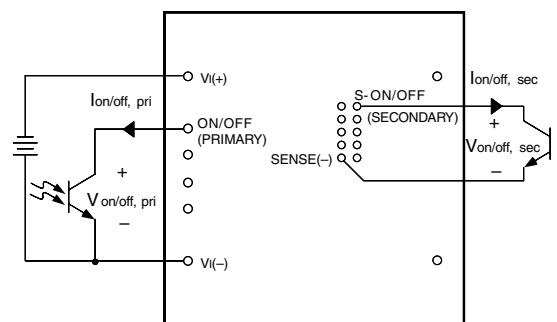

8-1398 (C)

Figure 20. Remote On/Off Implementation

Feature Descriptions (continued)

Remote Sense

Remote sense minimizes the effects of distribution losses by regulating the voltage at the remote-sense connections. The voltage between the remote-sense pins and the output terminals must not exceed the output voltage sense range given in the Feature Specifications table, i.e.:

$$[V_o(+)-V_o(-)] - [\text{SENSE}(+) - \text{SENSE}(-)] \leq 0.5 \text{ V}$$

The voltage between the $V_o(+)$ and $V_o(-)$ terminals must not exceed the output overvoltage shutdown voltage. This limit includes any increase in voltage due to remote-sense compensation and output voltage set-point adjustment (trim), see Figure 21.

For remote-sense operation with multiple paralleled units, see Forced Load Sharing (Parallel Operation) section.

If not using the remote-sense feature to regulate the output at the point of load, then connect $\text{SENSE}(+)$ to $V_o(+)$ and $\text{SENSE}(-)$ to $V_o(-)$ at the module.

Although the output voltage can be increased by both the remote sense and by the trim, the maximum increase for the output voltage is not the sum of both. The maximum increase is the larger of either the remote sense or the trim. Consult the factory if you need to increase the output voltage more than the above limitation.

The amount of power delivered by the module is defined as the voltage at the output terminals multiplied by the output current. When using remote sense and trim, the output voltage of the module can be increased, which at the same output current would increase the power output of the module. Care should be taken to ensure that the maximum output power of the module remains at or below the maximum rated power.

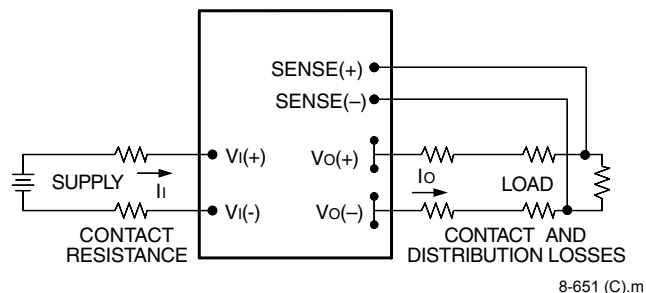

Figure 21. Effective Circuit Configuration for Single-Module Remote-Sense Operation

Output Voltage Set-Point Adjustment (Trim)

Output voltage trim ($V_o\text{TRIM}$ pin) enables the user to increase or decrease the output voltage set point of a module. This is accomplished by connecting an external resistor between the $V_o\text{TRIM}$ pin and either the $\text{SENSE}(+)$ or $\text{SENSE}(-)$ pins. The trim resistor should be positioned close to the module.

If not using the trim feature, leave the $V_o\text{TRIM}$ pin open.

With an external resistor between the $V_o\text{TRIM}$ and $\text{SENSE}(-)$ pins ($R_{\text{adj-down}}$), the output voltage set point ($V_{o, \text{adj}}$) decreases (see Figure 22).

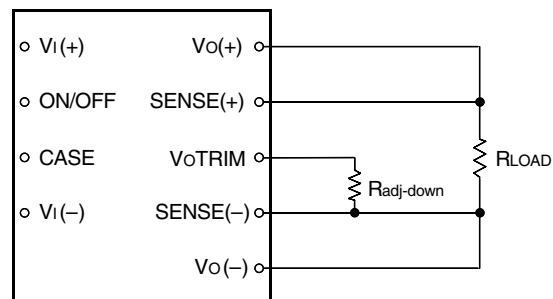

8-748 (C).e

Figure 22. Circuit Configuration to Decrease Output Voltage

The following equation determines the required external-resistor value to obtain a percentage output voltage change of $\Delta\%$.

$$R_{\text{adj-down}} = \left(\frac{100}{\Delta\%} - 2 \right) \text{ k}\Omega$$

The test results for this configuration are displayed in Figure 23. This figure applies to all output voltages.

Feature Descriptions (continued)

Output Voltage Set-Point Adjustment (Trim)

(continued)

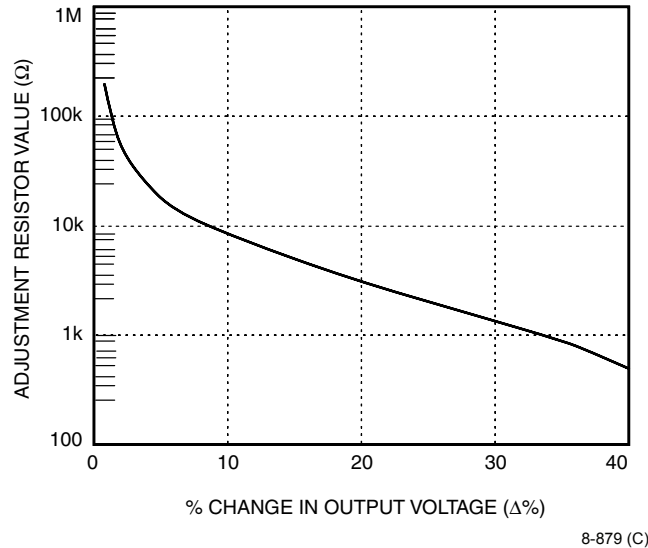

Figure 23. Resistor Selection for Decreased Output Voltage

With an external resistor connected between the VoTRIM and SENSE(+) pins (R_{adj-up}), the output voltage set point (V_{O, adj}) increases (see Figure 24).

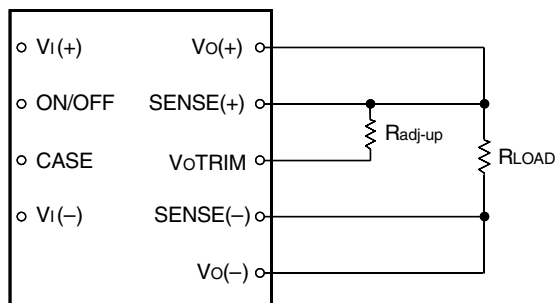

Figure 24. Circuit Configuration to Increase Output Voltage

The following equation determines the required external-resistor value to obtain a percentage output voltage change of $\gamma\%$.

$$R_{adj-up} = \left(\frac{V_o(100 + \Delta\%)}{1.225\Delta\%} - \frac{(100 + 2\Delta\%)}{\Delta\%} \right) \text{ k}\Omega$$

The test results for this configuration are displayed in Figure 25.

The voltage between the Vo(+) and Vo(-) terminals must not exceed the output overvoltage shutdown voltage.

Lineage Power

age. This limit includes any increase in voltage due to remote-sense compensation and output voltage set-point adjustment (trim).

Although the output voltage can be increased by both the remote sense and by the trim, the maximum increase for the output voltage is not the sum of both. The maximum increase is the larger of either the remote sense or the trim. Consult the factory if you need to increase the output voltage more than the above limitation.

The amount of power delivered by the module is defined as the voltage at the output terminals multiplied by the output current. When using remote sense and trim, the output voltage of the module can be increased, which at the same output current would increase the power output of the module. Care should be taken to ensure that the maximum output power of the module remains at or below the maximum rated power.

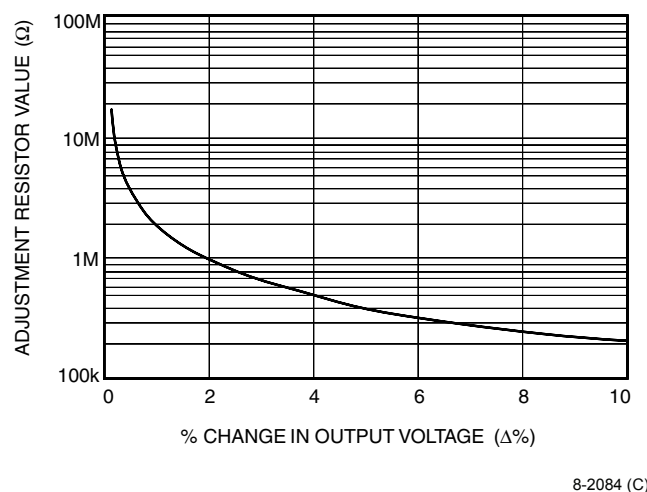

Figure 25. Resistor Selection for Increased Output Voltage

Output Overvoltage Protection

The output overvoltage shutdown consists of control circuitry, independent of the primary regulation loop, that monitors the voltage on the output terminals. The control loop of the clamp has a higher voltage set point than the primary loop (see Feature Specifications table). This provides a redundant voltage control that reduces the risk of output overvoltage and latches the converter off if an overvoltage occurs.

Recovery from latched shutdown is accomplished by cycling the dc input power off for at least 1.0 second or by toggling the primary or secondary referenced remote on/off signal for at least 1.0 second.

Feature Descriptions (continued)

Output Overvoltage Protection (continued)

The overvoltage shutdown set point can be lowered by placing a resistor between the overvoltage trim (OVTRIM) pin and SENSE(–) pin. This feature is useful if the output voltage of the converter has been trimmed down and a corresponding reduction in overvoltage trip point is desired.

The resistance required from a given overvoltage nominal set point is derived from the following equation:

$$R_{ov-adj} = \left(\frac{28.3 - 2 V_{ov-set}}{V_{ov-set} - 28.3} \right) \text{ k}\Omega$$

Where:

R_{ov-adj} is the value of an external resistor between the OVTRIM pin and SENSE(–) pin.

V_{ov-set} is the nominal adjusted set point of the overvoltage shutdown threshold.

Module Synchronization

Any module can be synchronized to any other module or to an external clock using the SYNC IN or SYNC OUT pins. The modules are not designed to operate in a master/slave configuration; that is, if one module fails, the other modules will continue to operate.

SYNC IN Pin

This pin can be connected either to an external clock or directly to the SYNC OUT pin of another JFW150x or FW300x module.

If an external clock signal is applied to the SYNC IN pin, the signal must be a 500 kHz (± 50 kHz) square wave with a 4 V_{p-p} amplitude. Operation outside this frequency band will detrimentally affect the performance of the module and must be avoided.

If the SYNC IN pin is connected to the SYNC OUT pin of another module, the connection should be as direct as possible, and the V_I(–) pins of the modules must be shorted together.

Unused SYNC IN pins should be tied to V_I(–). If the SYNC IN pin is not used, the module will operate from its own internal clock.

SYNC OUT Pin

This pin contains a clock signal referenced to the V_I(–) pin. The frequency of this signal will equal either the module's internal clock frequency or the frequency established by an external clock applied to the SYNC IN pin.

When synchronizing several modules together, the modules can be connected in a daisy-chain fashion where the SYNC OUT pin of one module is connected to the SYNC IN pin of another module. Each module in the chain will synchronize to the frequency of the first module in the chain.

To avoid loading effects, ensure that the SYNC OUT pin of any one module is connected to the SYNC IN pin of only one module. Any number of modules can be synchronized in this daisy-chain fashion.

Forced Load Sharing (Parallel Operation)

For either redundant operation or additional power requirements, the power module can be configured for parallel operation with forced load sharing (see Figure 26). For a typical redundant configuration, Schottky diodes or an equivalent should be used to protect against short-circuit conditions. Because of the remote sense, the forward-voltage drops across the Schottky diodes do not affect the set point of the voltage applied to the load. For additional power requirements, where multiple units are used to develop combined power in excess of the rated maximum, the Schottky diodes are not needed.

An internal anti-rollback circuit prevents either output voltage from falling more than 1 V below the other during light load operation.

Good layout techniques should be observed for noise immunity. To implement forced load sharing, the following connections must be made:

- The parallel pins of all units must be connected together. The paths of these connections should be as direct as possible.
- All remote-sense pins must be connected to the power bus at the same point. That is, connect all remote-sense (+) pins to the (+) side of the power bus at the same point, and connect all remote-sense (–) pins to the (–) side of the power bus at the same point. Close proximity and directness are necessary for good noise immunity.
- Add a 1000 pF capacitor across the PARALLEL pin and SENSE(–) pin of each module. Locate the capacitor as close to the module as possible.

Feature Descriptions (continued)

Forced Load Sharing (Parallel Operation)

(continued)

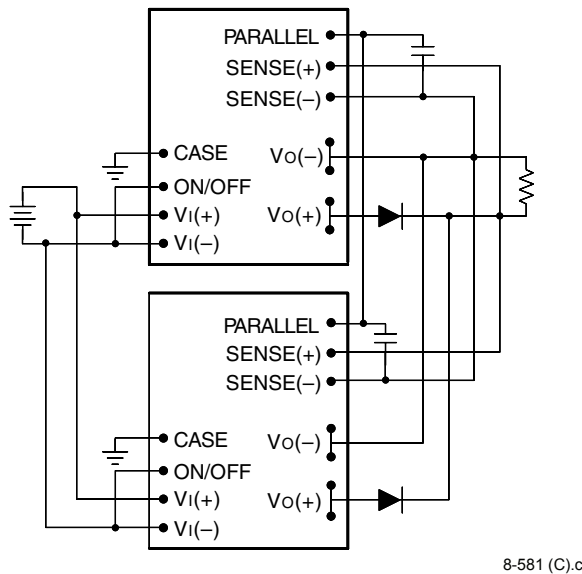

8-581 (C).c

Figure 26. Wiring Configuration for Redundant Parallel Operation

Output Current Monitor

The current monitor (CURMON) pin produces a dc voltage proportional to the dc output current of the module. The voltage is referenced to the secondary SENSE(-) pin and is typically 3.2 V at rated output current. For paralleling with FW300x modules, consult the factory for the V/A ratio. The output impedance of this pin is approximately 20 k Ω , so customer detection circuitry must have a high-impedance input.

Overtemperature Protection

These modules feature an overtemperature protection circuit to safeguard against thermal damage. The circuit shuts down and latches off the module when the maximum case temperature is exceeded. The module can be restarted by cycling the dc input power for at least 1.0 second or by toggling the primary or secondary referenced remote on/off signal for at least 1.0 second.

Power Good Signal

The power good signal (PWRGOOD pin) is an open-collector, secondary-referenced pin that is pulled low when all five of the following conditions are met:

1. The sensed output voltage is greater than half the rated nominal output voltage.
2. The overvoltage shutdown latch is not set.
3. The thermal shutdown latch is not set.
4. The unit is not in current limit.
5. Secondary internal bias is present.

There is one situation where the power good signal can be low even though the module has failed. This can occur when the module is paralleled with other modules for additional output power (i.e., the output ORing diodes would not be used). If one module power train stops delivering power (fails), the other paralleled module(s) would provide a voltage at the output pin of the failed module. The failed module would then not detect that its output power was not being delivered. However, in this situation, the current monitor pins of the paralleled modules would indicate that current is not being delivered from one module and that module had failed.

For redundant applications, the ORing diodes would keep the other module voltages from being applied to the failed module output and the power good signal would indicate a failure.

Thermal Warning Signal

The thermal warning (TEMPWARN) pin is a secondary-referenced, open collector output that shorts to SENSE(-) a few degrees before the module goes into thermal shutdown. When the module temperature cools, the thermal warning pin will open, but the unit will remain latched off until the input power or the primary or secondary referenced remote on/off is recycled for 1.0 second.

Thermal Considerations

Introduction

The JFW-Series power modules operate in a variety of thermal environments; however, sufficient cooling should be provided to help ensure reliable operation of the units. Heat-dissipating components inside the units are thermally coupled to the case. Heat is removed by conduction, convection, and radiation to the surrounding environment. Proper cooling can be verified by measuring the case temperature. Peak temperature (T_c) occurs at the position indicated in Figure 27.

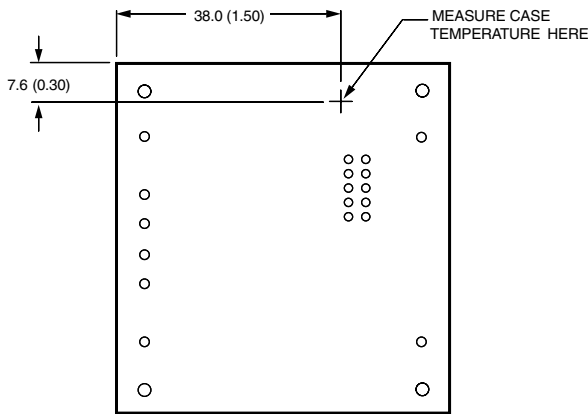

8-1397 (C).a

Note: Top view, measurements shown in millimeters and (inches).
Pin locations are for reference only.

Figure 27. Case Temperature Measurement Location

The temperature at this location should not exceed 100 °C. The output power of the module should not exceed the rated power for the module as listed in the Ordering Information table.

Although the maximum case temperature of the power modules is 100 °C, you can limit this temperature to a lower value for extremely high reliability.

For additional information regarding this module, refer to the *Thermal Management JC-, JFC-, JW-, and JFW-Series 50 W to 150 W Board-Mounted Power Modules* Technical Note (TN97-008EPS).

Heat Transfer Without Heat Sinks

Increasing airflow over the module enhances the heat transfer via convection. Figure 28 shows the maximum power that can be dissipated by the module without exceeding the maximum case temperature versus local ambient temperature (T_A) for natural convection through 4 m/s (800 ft./min.).

Note that the natural convection condition was measured at 0.05 m/s to 0.1 m/s (10 ft./min. to 20 ft./min.); however, systems in which this power module may be used typically generate a natural convection airflow rate of 0.3 m/s (60 ft./min.) due to other heat-dissipating components in the system. The use of Figure 28 is shown in the following example.

Example

What is the minimum airflow necessary for a JFW100H operating at $V_i = 54$ V, an output current of 4.2 A, and a maximum ambient temperature of 40 °C?

Solution

Given: $V_i = 54$ V
 $I_o = 4.2$ A
 $T_A = 40$ °C

Determine P_D (Use Figure 31.):

$$P_D = 12 \text{ W}$$

Determine airflow (v) (Use Figure 28.):

$$v = 1.0 \text{ m/s (200 ft./min.)}$$

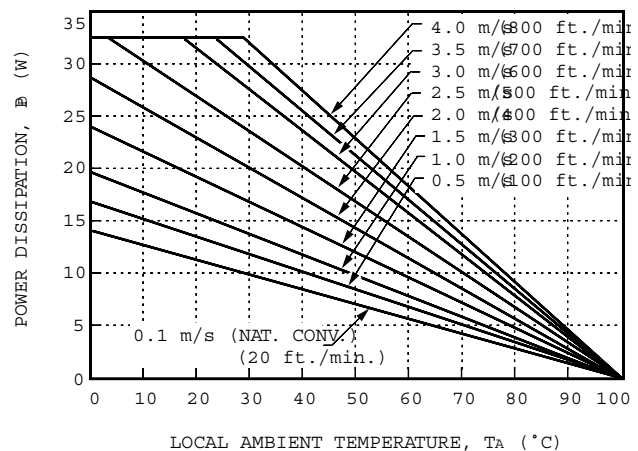

8-1150 (C).a

Figure 28. Forced Convection Power Derating with No Heat Sink; Either Orientation

Thermal Considerations (continued)

Heat Transfer Without Heat Sinks (continued)

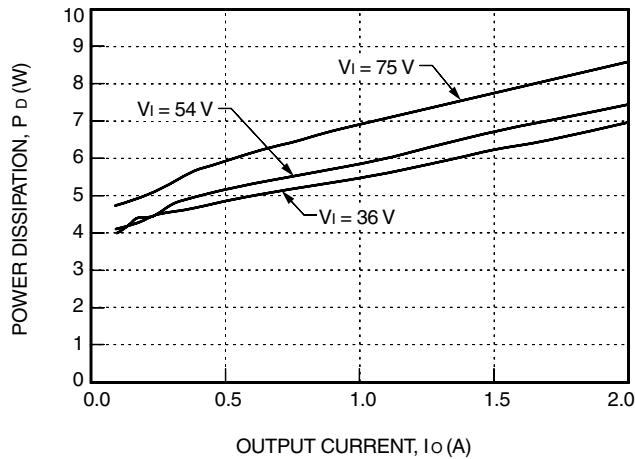

8-1295 (C).a

Figure 29. JFW050H Power Dissipation vs. Output Current at 25 °C

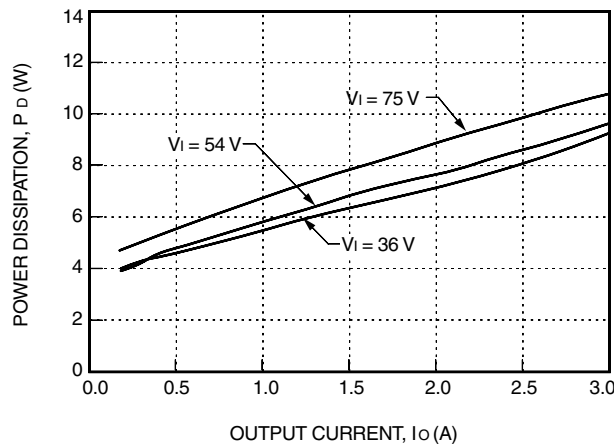

8-1296 (C).a

Figure 30. JFW075H Power Dissipation vs. Output Current at 25 °C

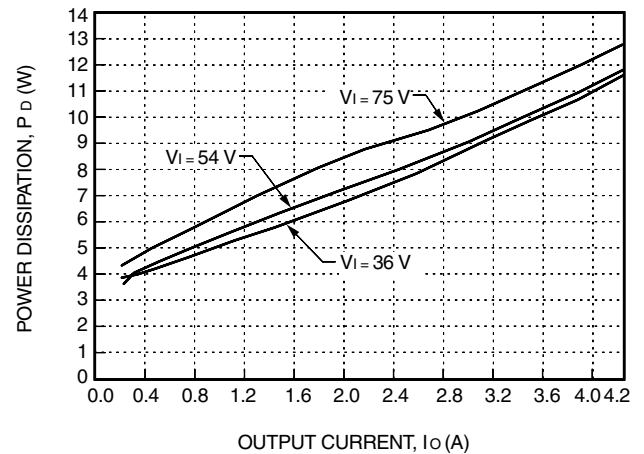

8-1297 (C).a

Figure 31. JFW100H Power Dissipation vs. Output Current at 25 °C

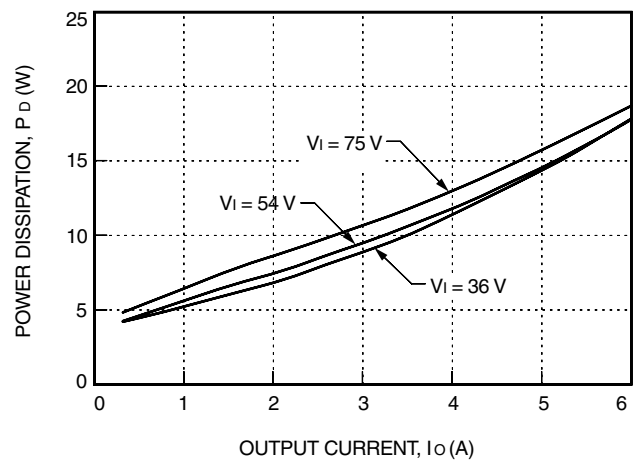

8-1298 (C).c

Figure 32. JFW150H Power Dissipation vs. Output Current at 25 °C

Heat Transfer with Heat Sinks

The power module has through-threaded, M3 x 0.5 mounting holes, which enable heat sinks or cold plates to attach to the module. The mounting torque must not exceed 0.56 N-m (5 in.-lb.). For a screw attachment from the pin side, the recommended hole size on the customer's PWB around the mounting holes is 0.130 ± 0.005 inches. If a larger hole is used, the mounting torque from the pin side must not exceed 0.25 N-m (2.2 in.-lb.).

Thermal Considerations (continued)

Heat Transfer with Heat Sinks (continued)

Thermal derating with heat sinks is expressed by using the overall thermal resistance of the module. Total module thermal resistance (θ_{ca}) is defined as the maximum case temperature rise ($\Delta T_{C, max}$) divided by the module power dissipation (P_D):

$$\theta_{ca} = \left[\frac{\Delta T_{C, max}}{P_D} \right] = \left[\frac{(T_C - T_A)}{P_D} \right]$$

The location to measure case temperature (T_C) is shown in Figure 27. Case-to-ambient thermal resistance vs. airflow for various heat sink configurations is shown in Figure 33. These curves were obtained by experimental testing of heat sinks, which are offered in the product catalog.

These measured resistances are from heat transfer from the sides and bottom of the module as well as the top side with the attached heat sink; therefore, the case-to-ambient thermal resistances shown are generally lower than the resistance of the heat sink by itself. The module used to collect the data in Figure 33 had a thermal-conductive dry pad between the case and the heat sink to minimize contact resistance. The use of Figure 33 is shown in the following example.

Example

If an 85 °C case temperature is desired, what is the minimum airflow necessary? Assume the JFW100H module is operating at nominal line and an output current of 4.2 A, maximum ambient air temperature of 40 °C, and heat sink of 1/2 inch.

Solution

- Given: $V_I = 54 V$
- $I_O = 4.2 A$
- $T_A = 40 \text{ }^\circ C$
- $T_C = 85 \text{ }^\circ C$
- Heat sink = 1/2 inch.

Determine P_D by using Figure 31:

$$P_D = 12 W$$

Then solve the following equation:

$$\theta_{ca} = \left[\frac{(T_C - T_A)}{P_D} \right]$$

$$\theta_{ca} = \left[\frac{(85 - 40)}{12} \right]$$

$$\theta_{ca} = 3.75 \text{ }^\circ C/W$$

Use Figure 33 to determine air velocity for the 1/2 inch heat sink. The minimum airflow necessary for the JFW150H module is about 0.6 m/s (125 ft./min.).

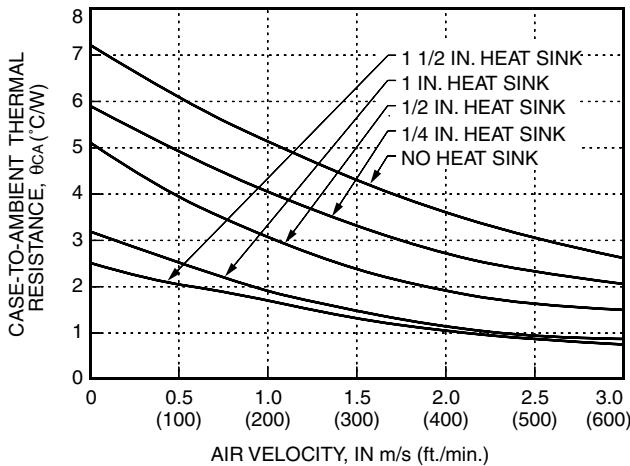

8-1153 (C).a

Figure 33. Case-to-Ambient Thermal Resistance Curves; Either Orientation

Custom Heat Sinks

A more detailed model can be used to determine the required thermal resistance of a heat sink to provide necessary cooling. The total module resistance can be separated into a resistance from case-to-sink (θ_{cs}) and sink-to-ambient (θ_{sa}) shown below (Figure 34).

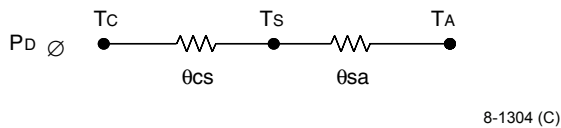

Figure 34. Resistance from Case-to-Sink and Sink-to-Ambient

For a managed interface using thermal grease or foils, a value of $\theta_{cs} = 0.1 \text{ }^\circ\text{C/W}$ to $0.3 \text{ }^\circ\text{C/W}$ is typical. The solution for heat sink resistance is:

$$\theta_{sa} = \left[\frac{(T_C - T_A)}{P_D} \right] - \theta_{cs}$$

This equation assumes that all dissipated power must be shed by the heat sink. Depending on the user-defined application environment, a more accurate model, including heat transfer from the sides and bottom of the module, can be used. This equation provides a conservative estimate for such instances.

EMC Considerations

For assistance with designing for EMC compliance, please refer to the FLTR100V10 data sheet (DS99-294EPS).

Layout Considerations

Copper paths must not be routed beneath the power module mounting inserts. For additional layout guidelines, refer to the FLTR100V10 data sheet (DS99-294EPS).

Outline Diagram

Dimensions are in millimeters and (inches).

Tolerances: $x.x \text{ mm} \pm 0.5 \text{ mm}$ ($x.xx \text{ in.} \pm 0.02 \text{ in.}$)
 $x.xx \text{ mm} \pm 0.25 \text{ mm}$ ($x.xxx \text{ in.} \pm 0.010 \text{ in.}$)

Top View

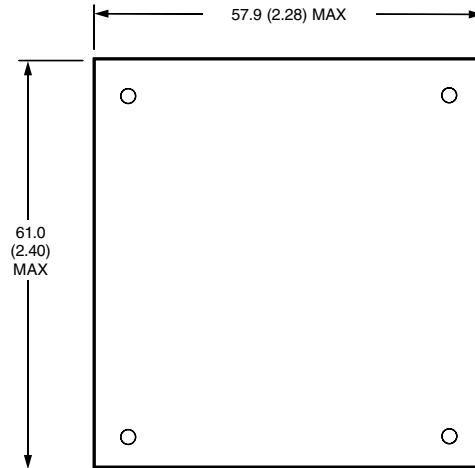

Side View

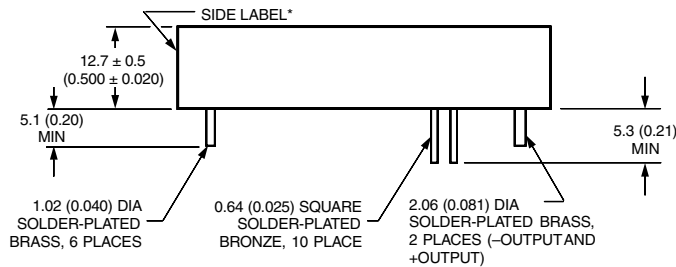

Bottom View

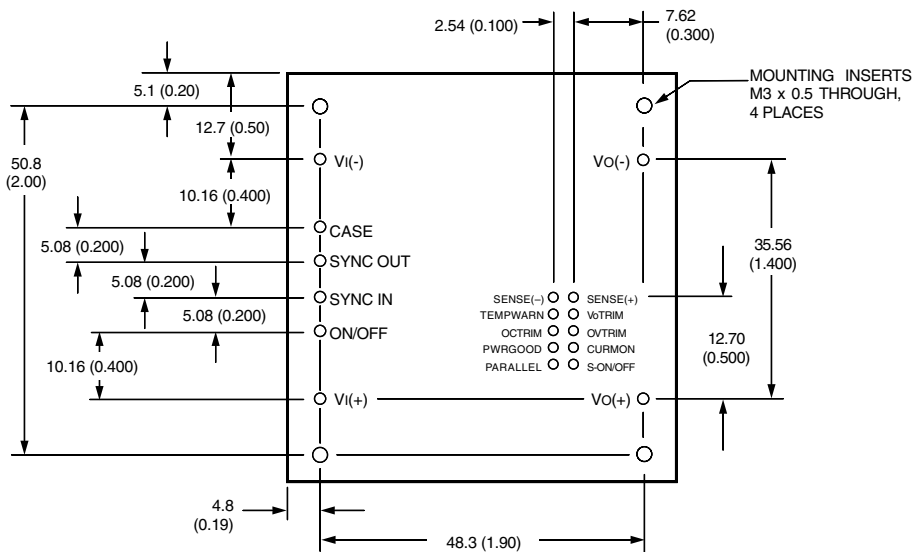

8-1397 (C).b

* Side label includes Lineage name, product designation, safety agency markings, input/output voltage and current ratings, and bar code.

Note: The control pins are on a 2.54 mm (0.100 in.) grid.

Ordering Information

Table 5. Device Codes

Input Voltage	Output Voltage	Output Power	Remote On/Off Logic	Device Code	Comcode
48 V	24.0 V	50 W	Negative	JFW050H1	108454885
48 V	24.0 V	75 W	Negative	JFW075H1	TBD
48 V	24.0 V	100 W	Negative	JFW100H1	TBD
48 V	24.0 V	150 W	Negative	JFW150H1	108243221
48 V	24.0 V	50 W	Positive	JFW050H	TBD
48 V	24.0 V	75 W	Positive	JFW075H	TBD
48 V	24.0 V	100 W	Positive	JFW100H	TBD
48 V	24.0 V	150 W	Positive	JFW150H	TBD

Optional features can be ordered using the suffixes shown in Table 4. The suffixes follow the last letter of the device code and are placed in descending order. For example, the device codes for a JFW150H module with the following options are shown below:

Positive logic	JFW150H
Negative logic	JFW150H1
Negative logic and delayed current-limit shutdown	JFW150H31

Table 6. Device Options

Option	Suffix
Delayed current-limit shutdown	3
Negative remote on/off logic	1
Positive remote on/off logic	—

Ordering Information (continued)

Table 7. Device Accessories

Accessory	Comcode
1/4 in. transverse kit (heat sink, thermal pad, and screws)	407243989
1/4 in. longitudinal kit (heat sink, thermal pad, and screws)	407243997
1/2 in. transverse kit (heat sink, thermal pad, and screws)	407244706
1/2 in. longitudinal kit (heat sink, thermal pad, and screws)	407244714
1 in. transverse kit (heat sink, thermal pad, and screws)	407244722
1 in. longitudinal kit (heat sink, thermal pad, and screws)	407244730
1 1/2 in. transverse kit (heat sink, thermal pad, and screws)	407244748
1 1/2 in. longitudinal kit (heat sink, thermal pad, and screws)	407244755

Dimensions are in millimeters and (inches).

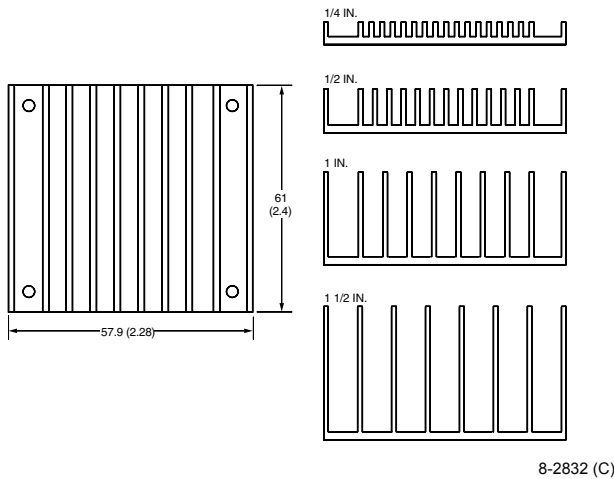

Figure 35. Longitudinal Heat Sink

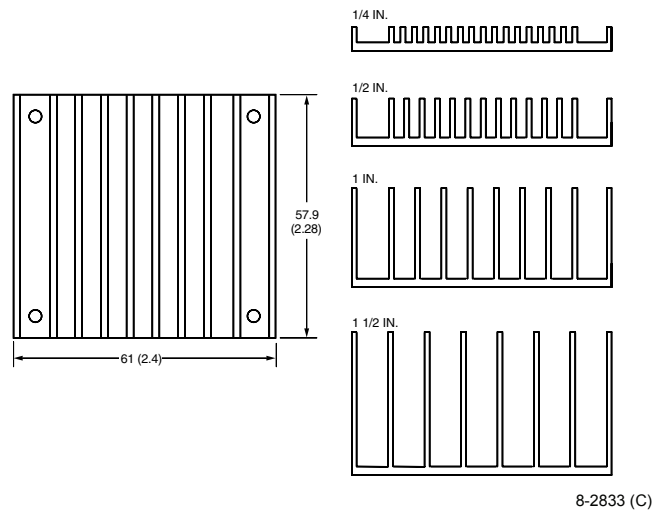

Figure 36. Transverse Heat Sink



World Wide Headquarters

Lineage Power Corporation

3000 Skyline Drive, Mesquite, TX 75149, USA

+1-800-526-7819

(Outside U.S.A.: **+1-972-284-2626**)

www.lineagepower.com

e-mail: techsupport1@lineagepower.com

Asia-Pacific Headquarters

Tel: +65 6416 4283

Europe, Middle-East and Africa Headquarters

Tel: +49 89 6089 286

India Headquarters

Tel: +91 80 28411633

Lineage Power reserves the right to make changes to the product(s) or information contained herein without notice. No liability is assumed as a result of their use or application. No rights under any patent accompany the sale of any such product(s) or information.

© 2008 Lineage Power Corporation, (Mesquite, Texas) All International Rights Reserved.

April 2008

DS99-130EPS (Replaces DS99-129EPS)