

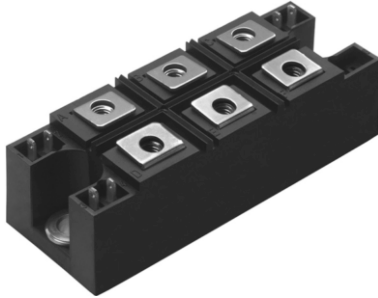

Three Phase Controlled Bridge (Power Modules), 55 A to 110 A



MTK

FEATURES

- Package fully compatible with the industry standard INT-A-PAK power modules series
- High thermal conductivity package, electrically insulated case
- Excellent power volume ratio
- 4000 V_{RMS} isolating voltage
- UL E78996 approved 
- Compliant to RoHS directive 2002/95/EC
- Designed and qualified for industrial level



RoHS
COMPLIANT

PRODUCT SUMMARY

I_o	55 A to 110 A
-------	---------------

DESCRIPTION

A range of extremely compact, encapsulated three phase controlled bridge rectifiers offering efficient and reliable operation. They are intended for use in general purpose and heavy duty applications.

MAJOR RATINGS AND CHARACTERISTICS

SYMBOL	CHARACTERISTICS	5.MT...K	9.MT...K	11.MT...K	UNITS
I_o		55	90	110	A
	T_C	85	85	85	°C
I_{FSM}	50 Hz	390	950	1130	A
	60 Hz	410	1000	1180	
I^2t	50 Hz	770	4525	6380	A ² s
	60 Hz	700	4130	5830	
$I^2\sqrt{t}$		7700	45 250	63 800	A ² √s
V_{RRM}	Range	800 to 1600			V
T_{Stg}, T_J	Range	- 40 to 125			°C

5.MT...KPbF, 9.MT...KPbF, 11.MT...KPbF Series



Vishay High Power Products Three Phase Controlled Bridge
(Power Modules), 55 A to 110 A

ELECTRICAL SPECIFICATIONS

VOLTAGE RATINGS					
TYPE NUMBER	VOLTAGE CODE	V _{RRM} , MAXIMUM REPETITIVE PEAK REVERSE VOLTAGE V	V _{RSM} , MAXIMUM NON-REPETITIVE PEAK REVERSE VOLTAGE V	V _{DRM} , MAXIMUM REPETITIVE PEAK OFF-STATE VOLTAGE, GATE OPEN CIRCUIT V	I _{RRM} /I _{DRM} , MAXIMUM AT T _J = 125 °C mA
5.MT...K	80	800	900	800	10
	100	1000	1100	1000	
	120	1200	1300	1200	
	140	1400	1500	1400	
	160	1600	1700	1600	
9.MT...K 11.MT...K	80	800	900	800	20
	100	1000	1100	1000	
	120	1200	1300	1200	
	140	1400	1500	1400	
	160	1600	1700	1600	

FORWARD CONDUCTION								
PARAMETER	SYMBOL	TEST CONDITIONS			5.MT...K	9.MT...K	11.MT...K	UNITS
Maximum DC output current at case temperature	I _O	120° rect. conduction angle			55	90	110	A
					85	85	85	°C
Maximum peak, one-cycle forward, non-repetitive on state surge current	I _{TSM}	t = 10 ms	No voltage reappplied	Initial T _J = T _J maximum	390	950	1130	A
		t = 8.3 ms			410	1000	1180	
		t = 10 ms	100 % V _{RRM} reappplied		330	800	950	
		t = 8.3 ms			345	840	1000	
Maximum I ² t for fusing	I ² t	t = 10 ms	No voltage reappplied		770	4525	6380	A ² s
		t = 8.3 ms			700	4130	5830	
		t = 10 ms	100 % V _{RRM} reappplied		540	3200	4510	
		t = 8.3 ms			500	2920	4120	
Maximum I ² √t for fusing	I ² √t	t = 0.1 ms to 10 ms, no voltage reappplied			7700	45 250	63 800	A ² √s
Low level value of threshold voltage	V _{T(TO)1}	(16.7 % × π × I _{T(AV)} < I < π × I _{T(AV)}), T _J maximum			1.17	1.09	1.04	V
High level value of threshold voltage	V _{T(TO)2}	(I > π × I _{T(AV)}), T _J maximum			1.45	1.27	1.27	
Low level value on-state slope resistance	r _{t1}	(16.7 % × π × I _{T(AV)} < I < π × I _{T(AV)}), T _J maximum			12.40	4.10	3.93	mΩ
High level value on-state slope resistance	r _{t2}	(I > π × I _{T(AV)}), T _J maximum			11.04	3.59	3.37	
Maximum on-state voltage drop	V _{TM}	I _{pk} = 150 A, T _J = 25 °C, t _p = 400 μs single junction			2.68	1.65	1.57	V
Maximum non-repetitive rate of rise of turned on current	di/dt	T _J = 25 °C, from 0.67 V _{DRM} , I _{TM} = π × I _{T(AV)} , I _g = 500 mA, t _r < 0.5 μs, t _p > 6 μs			150			A/μs
Maximum holding current	I _H	T _J = 25 °C, anode supply = 6 V, resistive load, gate open circuit			200			mA
Maximum latching current	I _L	T _J = 25 °C, anode supply = 6 V, resistive load			400			



5.MT...KPbF, 9.MT...KPbF, 11.MT...KPbF Series

Three Phase Controlled Bridge Vishay High Power Products
(Power Modules), 55 A to 110 A

BLOCKING						
PARAMETER	SYMBOL	TEST CONDITIONS	5.MT...K	9.MT...K	11.MT...K	UNITS
RMS isolation voltage	V_{ISOL}	$T_J = 25\text{ °C}$ all terminal shorted, $f = 50\text{ Hz}$, $t = 1\text{ s}$	4000			V
Maximum critical rate of rise of off-state voltage	dV/dt ⁽¹⁾	$T_J = T_J$ maximum, linear to $0.67 V_{DRM}$, gate open circuit	500			V/ μ s

Note

(1) Available with $dV/dt = 1000\text{ V}/\mu\text{s}$, to complete code add S90 i. e. 113MT160KBS90

TRIGGERING						
PARAMETER	SYMBOL	TEST CONDITIONS	5.MT...K	9.MT...K	11.MT...K	UNITS
Maximum peak gate power	P_{GM}	$T_J = T_J$ maximum	10			W
Maximum average gate power	$P_{G(AV)}$		2.5			
Maximum peak gate current	I_{GM}		2.5			A
Maximum peak negative gate voltage	$-V_{GT}$		10			V
Maximum required DC gate voltage to trigger	V_{GT}	$T_J = -40\text{ °C}$	4.0			
		$T_J = 25\text{ °C}$	2.5			
		$T_J = 125\text{ °C}$	1.7			
Maximum required DC gate current to trigger	I_{GT}	$T_J = -40\text{ °C}$	270			mA
		$T_J = 25\text{ °C}$	150			
		$T_J = 125\text{ °C}$	80			
Maximum gate voltage that will not trigger	V_{GD}	$T_J = T_J$ maximum, rated V_{DRM} applied	0.25			V
Maximum gate current that will not trigger	I_{GD}		6			mA

THERMAL AND MECHANICAL SPECIFICATIONS						
PARAMETER	SYMBOL	TEST CONDITIONS	5.MT...K	9.MT...K	11.MT...K	UNITS
Maximum junction operating and storage temperature range	T_J, T_{Stg}		- 40 to 125			°C
Maximum thermal resistance, junction to case	R_{thJC}	DC operation per module	0.18	0.14	0.12	K/W
		DC operation per junction	1.07	0.86	0.70	
		120 °C rect. conduction angle per module	0.19	0.15	0.12	
		120 °C rect. conduction angle per junction	1.17	0.91	0.74	
Maximum thermal resistance, case to heatsink per module	R_{thCS}	Mounting surface smooth, flat and grased	0.03			
Mounting torque $\pm 10\%$	to heatsink to terminal	A mounting compound is recommended and the torque should be rechecked after a period of 3 hours to allow for the spread of the compound. Lubricated threads.	4 to 6			Nm
			3 to 4			
Approximate weight				225		

5.MT...KPbF, 9.MT...KPbF, 11.MT...KPbF Series



Vishay High Power Products Three Phase Controlled Bridge (Power Modules), 55 A to 110 A

ΔR CONDUCTION PER JUNCTION											
DEVICES	SINUSOIDAL CONDUCTION AT T _J MAXIMUM					RECTANGULAR CONDUCTION AT T _J MAXIMUM					UNITS
	180°	120°	90°	60°	30°	180°	120°	90°	60°	30°	
5.MT...K	0.072	0.085	0.108	0.152	0.233	0.055	0.091	0.117	0.157	0.236	K/W
9.MT...K	0.033	0.039	0.051	0.069	0.099	0.027	0.044	0.055	0.071	0.100	
11.MT...K	0.027	0.033	0.042	0.057	0.081	0.023	0.037	0.046	0.059	0.082	

Note

- Table shows the increment of thermal resistance R_{thJC} when devices operate at different conduction angles than DC

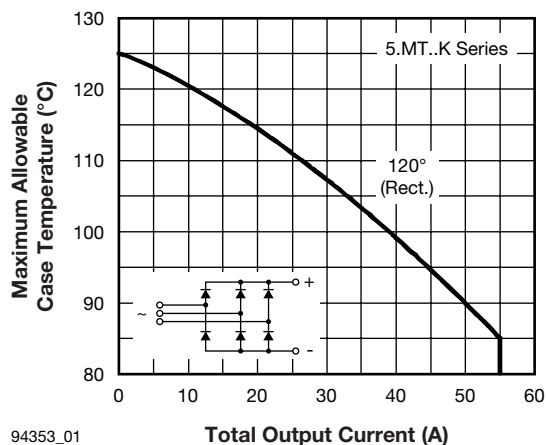

Fig. 1 - Current Ratings Characteristic

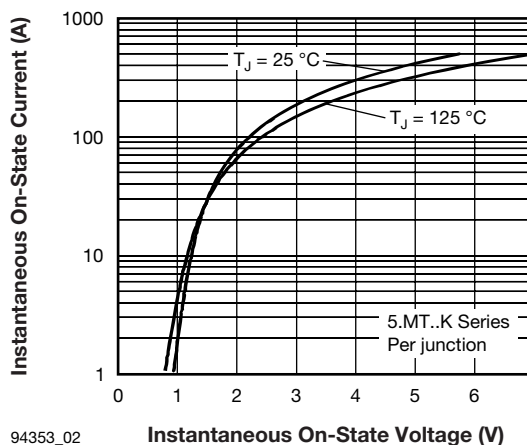

Fig. 2 - Forward Voltage Drop Characteristics

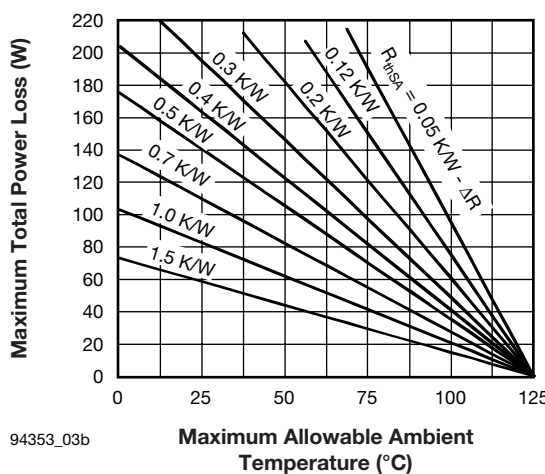
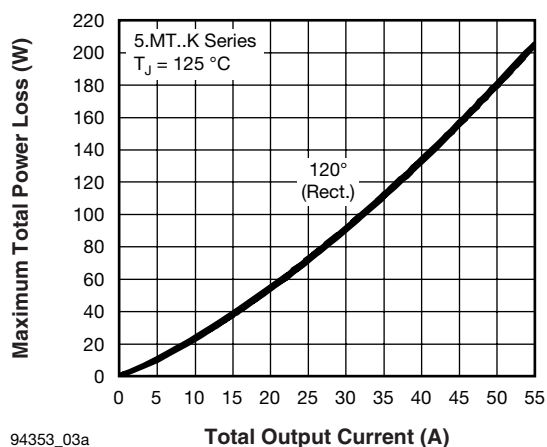
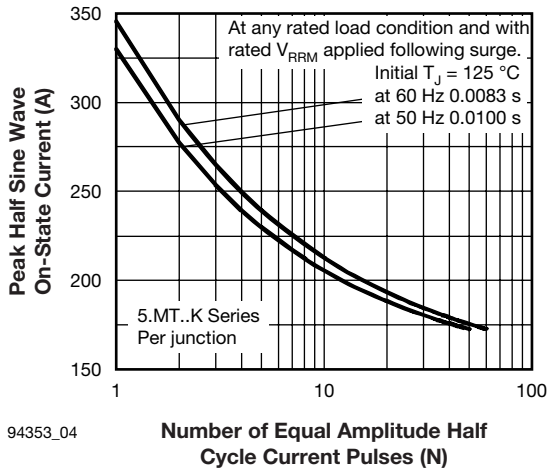

Fig. 3 - Total Power Loss Characteristics



5.MT...KPbF, 9.MT...KPbF, 11.MT...KPbF Series

Three Phase Controlled Bridge Vishay High Power Products
(Power Modules), 55 A to 110 A



94353_04

Fig. 4 - Maximum Non-Repetitive Surge Current

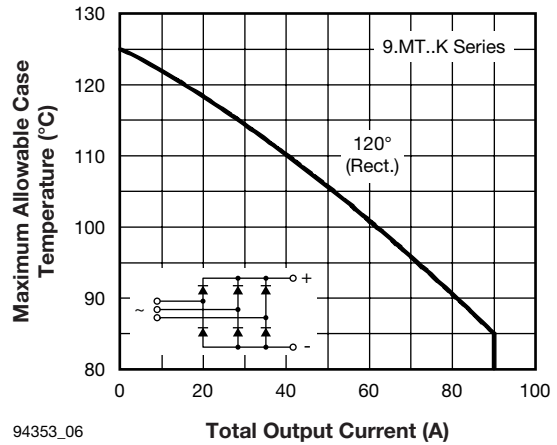

94353_06

Fig. 6 - Current Ratings Characteristic

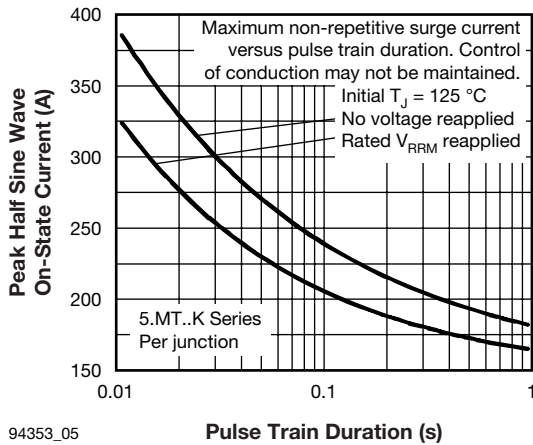

94353_05

Fig. 5 - Maximum Non-Repetitive Surge Current

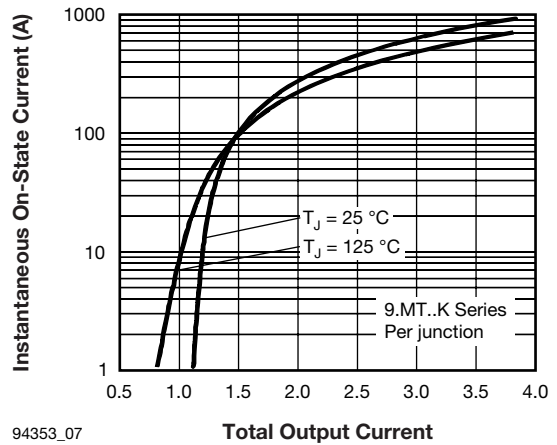

94353_07

Fig. 7 - Forward Voltage Drop Characteristics

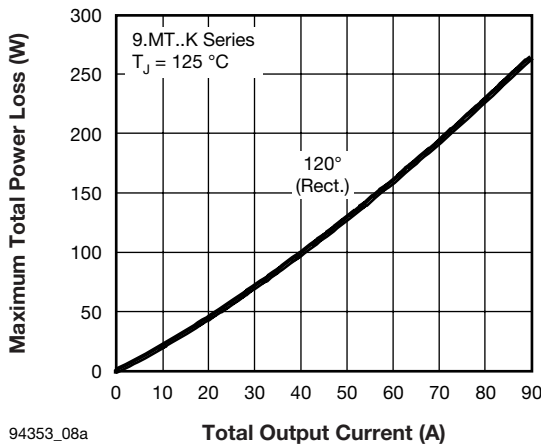

94353_08a

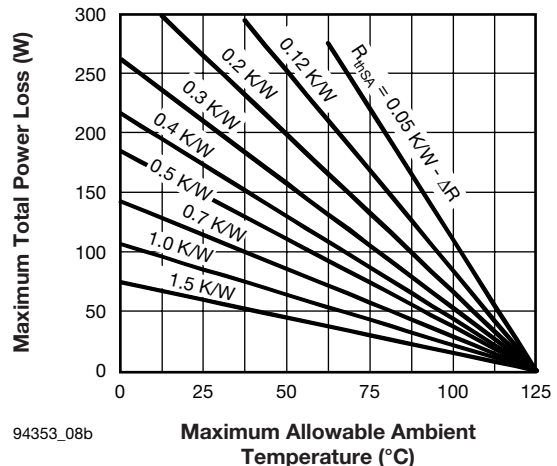

94353_08b

Fig. 8 - Total Power Loss Characteristics

5.MT...KPbF, 9.MT...KPbF, 11.MT...KPbF Series



Vishay High Power Products Three Phase Controlled Bridge (Power Modules), 55 A to 110 A

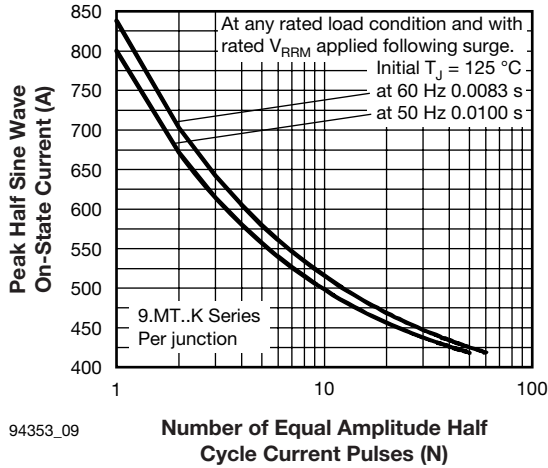

Fig. 9 - Maximum Non-Repetitive Surge Current

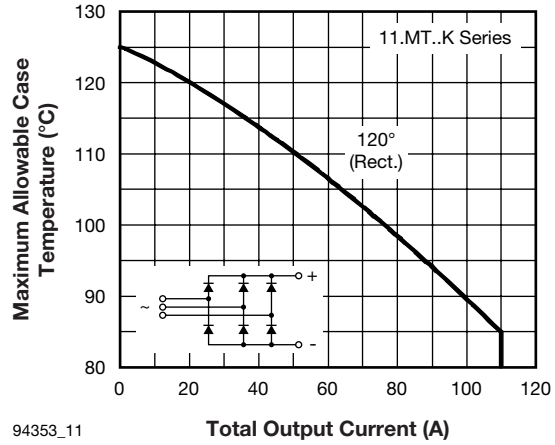

Fig. 11 - Current Ratings Characteristic

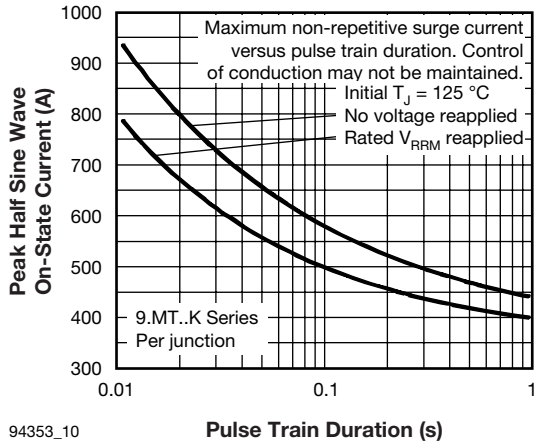

Fig. 10 - Maximum Non-Repetitive Surge Current

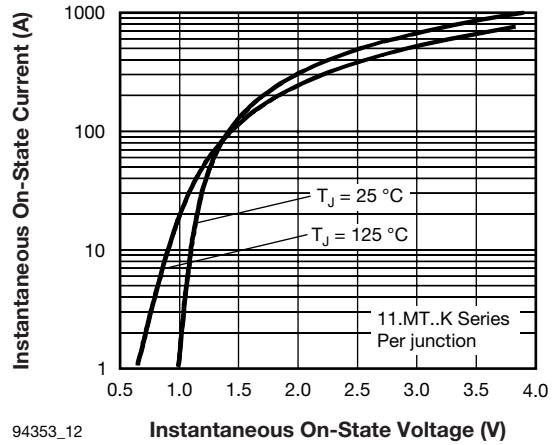

Fig. 12 - Forward Voltage Drop Characteristics

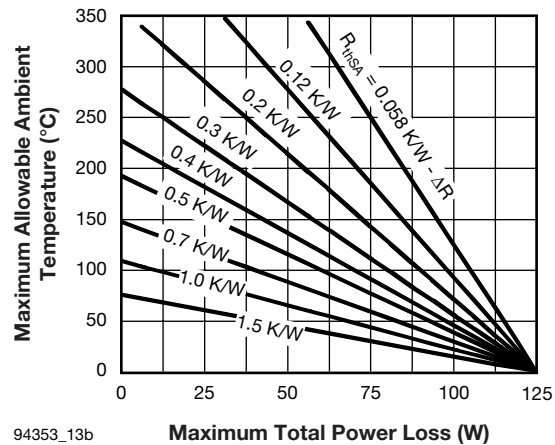
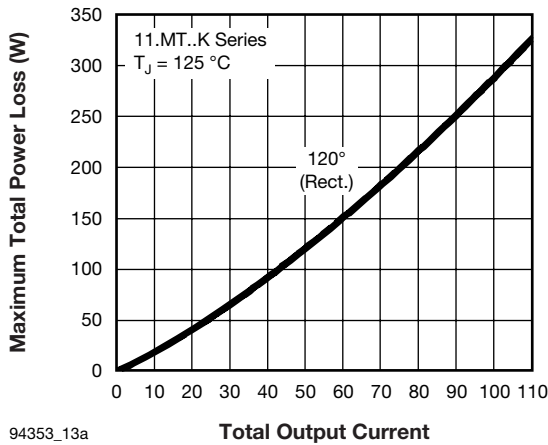

Fig. 13 - Total Power Loss Characteristics



5.MT...KPbF, 9.MT...KPbF, 11.MT...KPbF Series

Three Phase Controlled Bridge Vishay High Power Products
(Power Modules), 55 A to 110 A

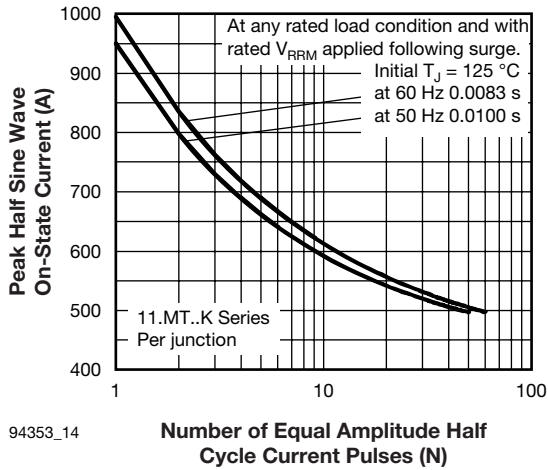

Fig. 14 - Maximum Non-Repetitive Surge Current

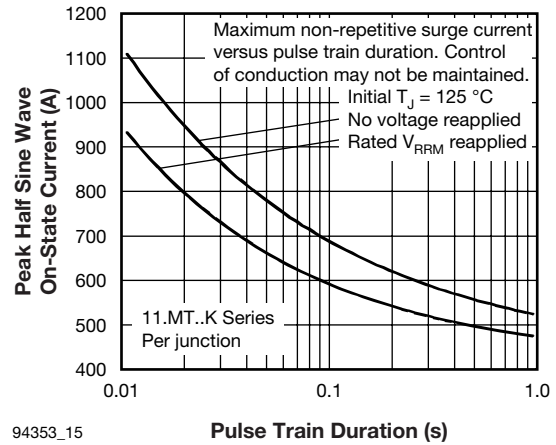

Fig. 15 - Maximum Non-Repetitive Surge Current

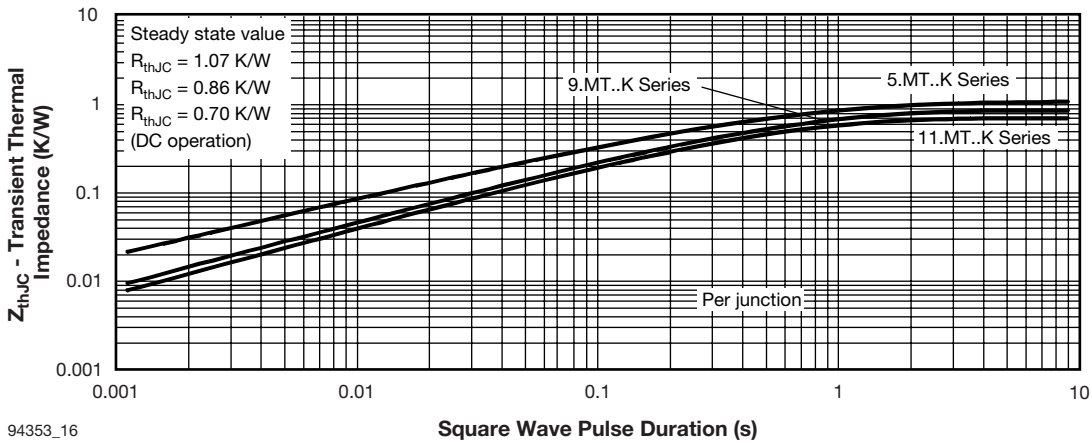

Fig. 16 - Thermal Impedance Z_{thJC} Characteristics

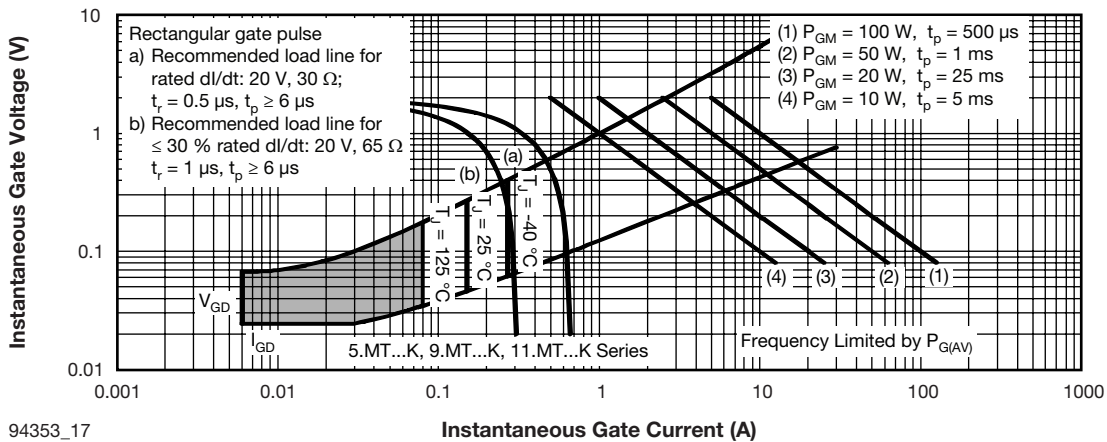

Fig. 17 - Gate Characteristics

5.MT...KPbF, 9.MT...KPbF, 11.MT...KPbF Series



Vishay High Power Products Three Phase Controlled Bridge
(Power Modules), 55 A to 110 A

ORDERING INFORMATION TABLE

Device code	11	3	MT	160	K	S90	PbF
	①	②	③	④	⑤	⑥	

- 1** - Current rating code:
 - 5 = 55 A (average)
 - 9 = 90 A (average)
 - 11 = 110 A (average)
- 2** - Circuit configuration code:
 - 1 = Negative half-controlled bridge
 - 2 = Positive half-controlled bridge
 - 3 = Full-controlled bridge
- 3** - Essential part number
- 4** - Voltage code x 10 = V_{RRM} (see Voltage Ratings table)
- 5** - Critical dV/dt:
 - None = 500 V/ μ s (standard value)
 - S90 = 1000 V/ μ s (special selection)
- 6** - PbF = Lead (Pb)-free

Note

- To order the optional hardware go to www.vishay.com/doc?95172

CIRCUIT CONFIGURATION

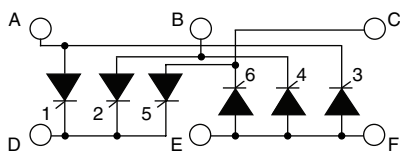

Full-controlled bridge
(5.MT...K, 9.MT...K, 11.MT...K)

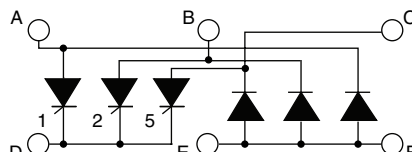

Positive half-controlled bridge
(5.MT...K, 9.MT...K, 11.MT...K)

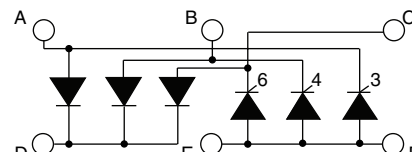

Negative half-controlled bridge
(5.MT...K, 9.MT...K, 11.MT...K)

LINKS TO RELATED DOCUMENTS

Dimensions	www.vishay.com/doc?95004
------------	--



Disclaimer

All product specifications and data are subject to change without notice.

Vishay Intertechnology, Inc., its affiliates, agents, and employees, and all persons acting on its or their behalf (collectively, "Vishay"), disclaim any and all liability for any errors, inaccuracies or incompleteness contained herein or in any other disclosure relating to any product.

Vishay disclaims any and all liability arising out of the use or application of any product described herein or of any information provided herein to the maximum extent permitted by law. The product specifications do not expand or otherwise modify Vishay's terms and conditions of purchase, including but not limited to the warranty expressed therein, which apply to these products.

No license, express or implied, by estoppel or otherwise, to any intellectual property rights is granted by this document or by any conduct of Vishay.

The products shown herein are not designed for use in medical, life-saving, or life-sustaining applications unless otherwise expressly indicated. Customers using or selling Vishay products not expressly indicated for use in such applications do so entirely at their own risk and agree to fully indemnify Vishay for any damages arising or resulting from such use or sale. Please contact authorized Vishay personnel to obtain written terms and conditions regarding products designed for such applications.

Product names and markings noted herein may be trademarks of their respective owners.