

AC16DGM to AC16FGM

16 A MOLD TRIAC

PACKAGE DIMENSIONS in millimeters

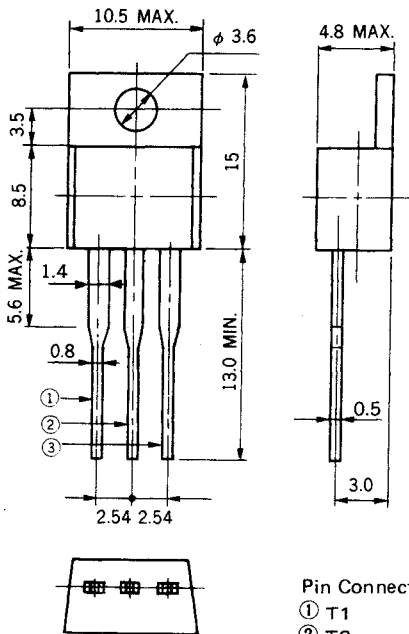

The AC16DGM to AC16FGM are all diffused mold type TRIAC granted RMS On-state current 16 Amps, with rated voltages up to 600 Volts.

FEATURES

- 150 A Surge Current
- TO-220AB mold package
- Low cost

APPLICATIONS

Motor speed control,
Lamp dimmer, Temperature controllers,
Various solid state switches, etc.

MAXIMUM RATINGS

ITEM	SYMBOL	AC16DGM	AC16EGM	AC16FGM	UNIT	NOTE
Repetitive Peak-off Voltage	V_{DRM}	400	500	600	V	
Non-Repetitive Peak-off Voltage	V_{DSM}	500	600	700	V	
RMS On-state Current	$I_{T(RMS)}$	16 ($T_c = 100^\circ C$)			A	See Fig. 11, 12
Surge On-state Current	I_{TSM}	150 (50 Hz Non-repetitive)			A	See Fig. 2
Fusing Current	$\int i_T^2 dt$	100			A ² S	
Peak Gate Power Dissipation	P_{GM}	5			W	
Average Gate Power Dissipation	$P_{G(AV)}$	0.5			W	
Peak Gate Current	I_{GM}	±3			A	
Junction Temperature	T_j	-40 to +125			°C	
Storage Temperature	T_{stg}	-40 to +125			°C	

ELECTRICAL CHARACTERISTICS (T_j = 25 °C)

ITEM	SYMBOL	TEST CONDITIONS	MIN.	TYP.	MAX.	UNIT	NOTE	
Peak Off-State Current	I _{DRM}	V _{DM} = V _{DRM}	T _j = 25 °C	-	-	0.1	mA	-
			T = 125 °C	-	-	2		
On-State Voltage	V _{TM}	I _{TM} = 25 A	-	-	1.4	V	See Fig. 1	
Critical Rate of Rise of Off-state Voltage	dv/dt	T _j = 125 °C V _{DM} = $\frac{2}{3}$ V _{DRM}	-	100	-	V/μs	-	
DC Gate Trigger Current	I _{GT}	V _{DM} = 12 V R _L = 30 Ω	T ₂ +, G+	-	-	30	mA	See Fig. 3, 4, 5, 7
			T ₂ -, G+	-	-	80		
			T ₂ -, G-	-	-	30		
			T ₂ +, G-	-	-	30		
DC Gate Trigger Voltage	V _{GT}	V _{DM} = 12 V R _L = 30 Ω	T ₂ +, G+	-	-	1.5	V	See Fig. 3, 4, 6, 8
			T ₂ -, G+	-	-	2.0		
			T ₂ -, G-	-	-	1.5		
			T ₂ +, G-	-	-	1.5		
Gate Non-Trigger Voltage	V _{GD}	T _j = 125 °C V _{DM} = $\frac{1}{2}$ V _{DRM}	0.3	-	-	V	-	
DC Holding Current	I _H	V _D = 24 V	-	30	-	mA		
Critical Rate of Rise of Commutating Off-State Voltage	(dv/dt) _c	T _j = 125 °C, I _{TM} = 22 A (di _T /dt) _c = -8 A/ms V _D = 400 V	10	-	-	V/μs		
Thermal Resistance	R _{th(j-c)}	Junction-to-Case	-	-	1.5	°C/W	See Fig. 13	

Trigger Mode & Test Circuit

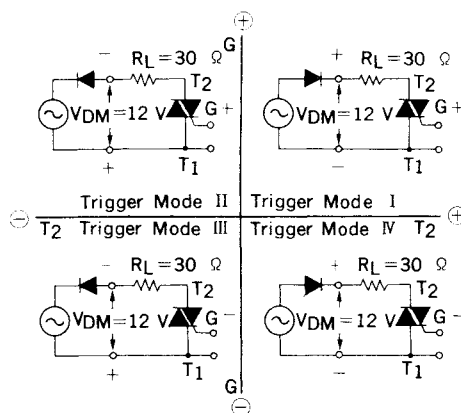

Fig. 1 $i_T - v_T$ CHARACTERISTIC

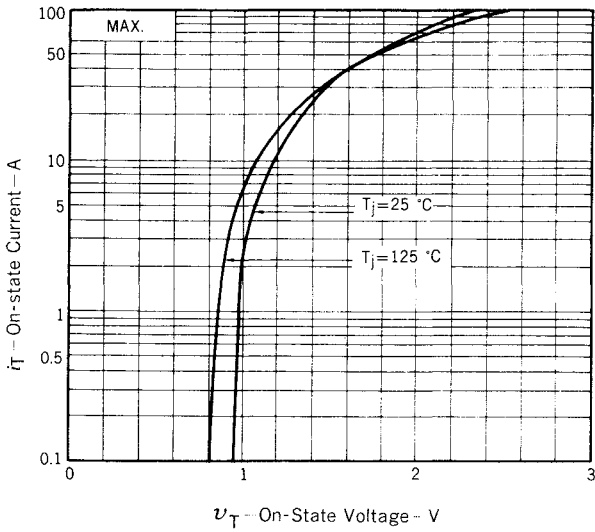

Fig. 2 I_{TSM} RATING

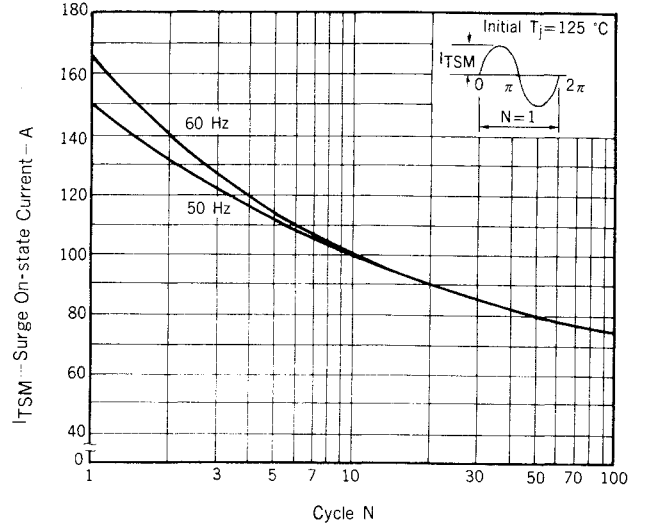

Fig. 3 $V_G - I_G$ RATING

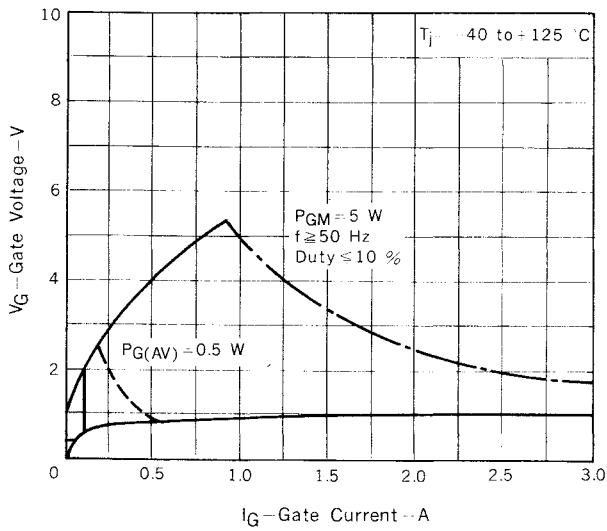

Fig. 4 $V_{GT} - I_{GT}$ CHARACTERISTIC

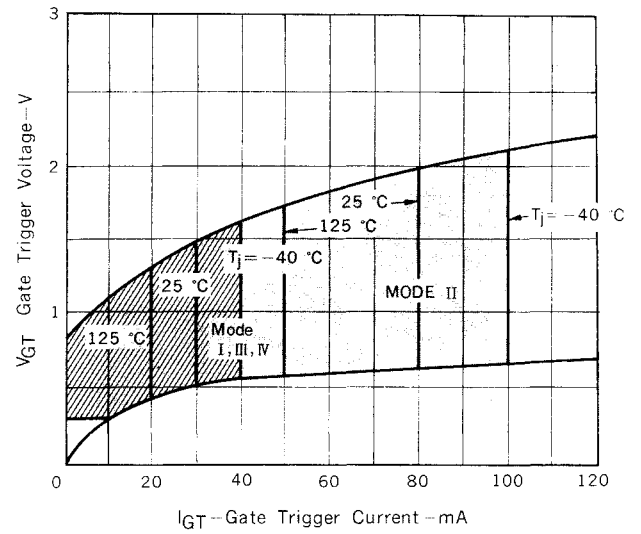

Fig. 5 $I_{GT} - T_a$ TYPICAL DISTRIBUTION

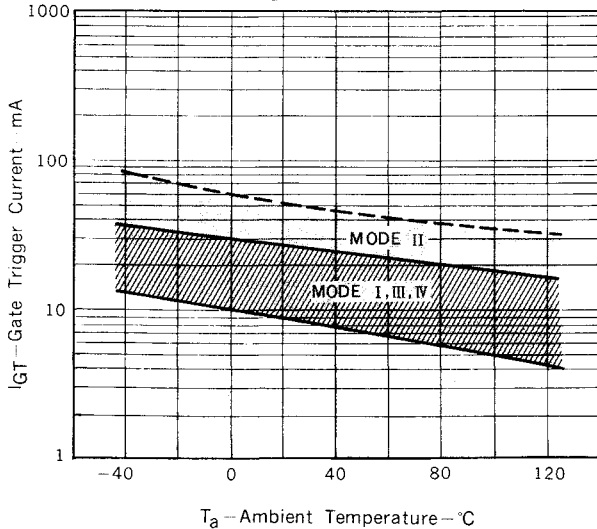

Fig. 6 $V_{GT} - T_a$ TYPICAL DISTRIBUTION

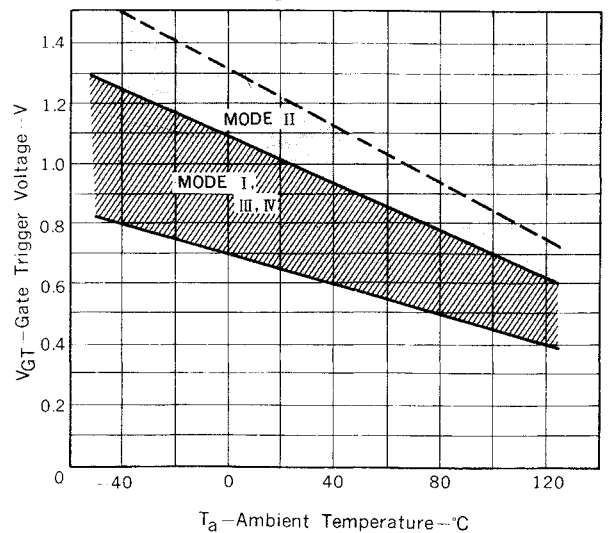

Fig. 7 $i_{GT} - \tau$ TYPICAL DISTRIBUTION

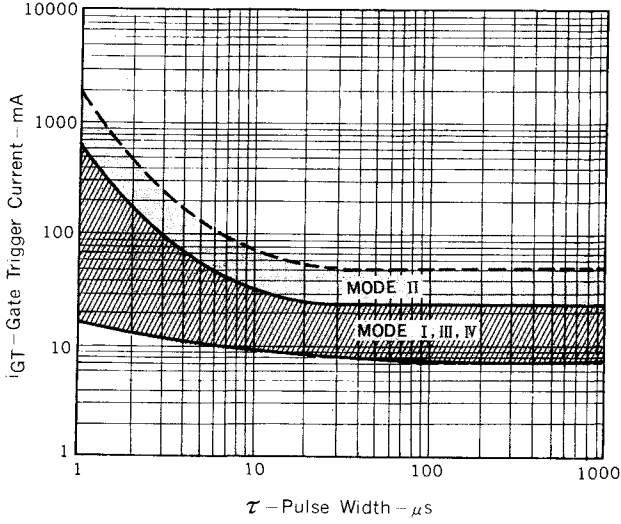

Fig. 8 $v_{GT} - \tau$ TYPICAL DISTRIBUTION

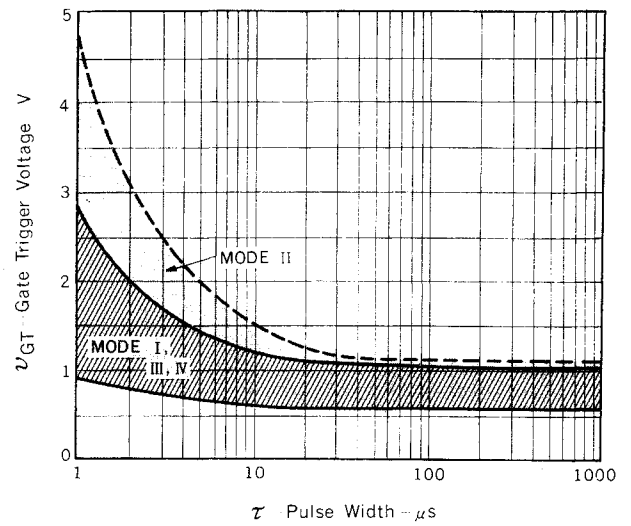

Fig. 9 $I_H - T_a$ CHARACTERISTIC

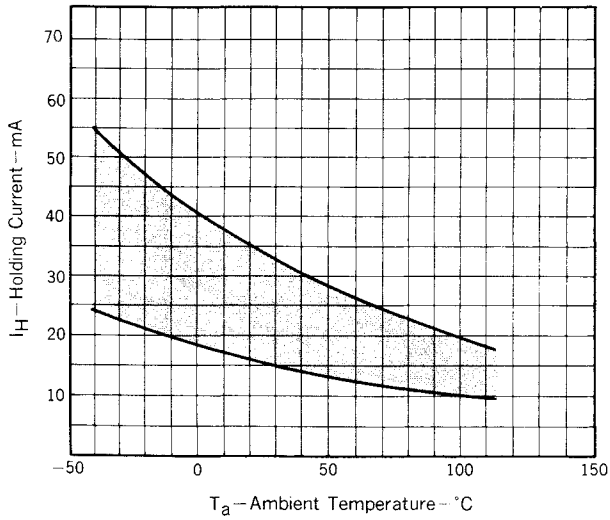

Fig. 10 $P_{T(AV)} - I_{T(RMS)}$ CHARACTERISTIC

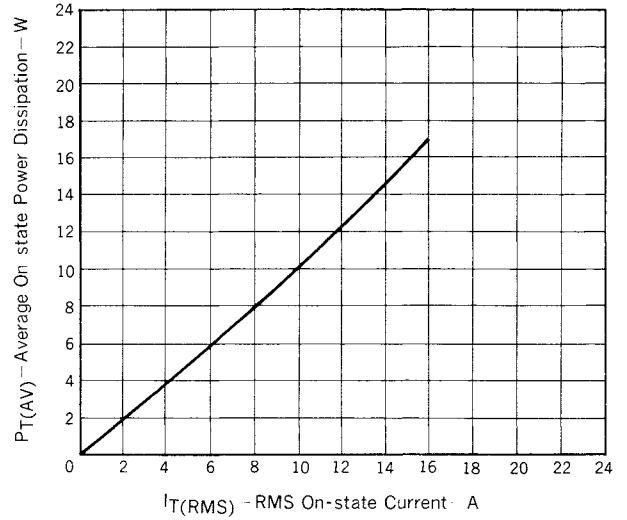

Fig. 11 $T_c - I_{T(RMS)}$ RATING

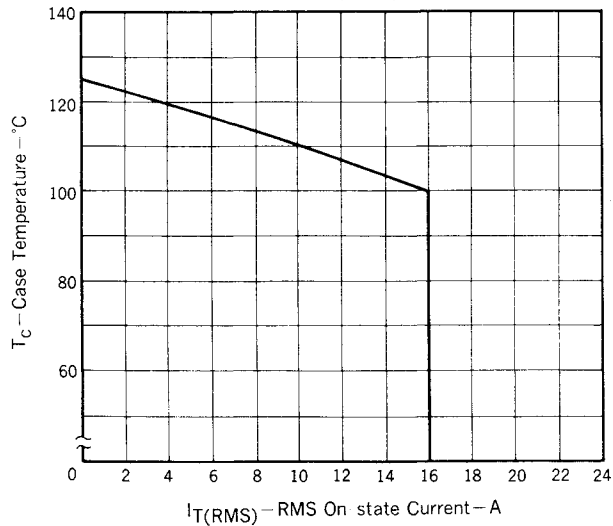

Fig. 12 $T_a - I_{T(RMS)}$ RATING

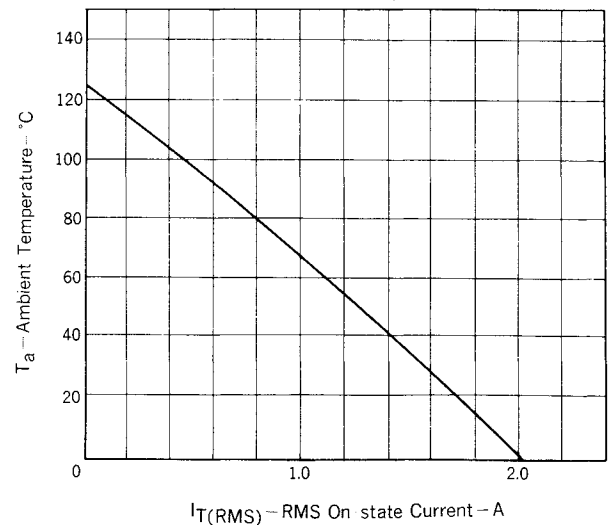
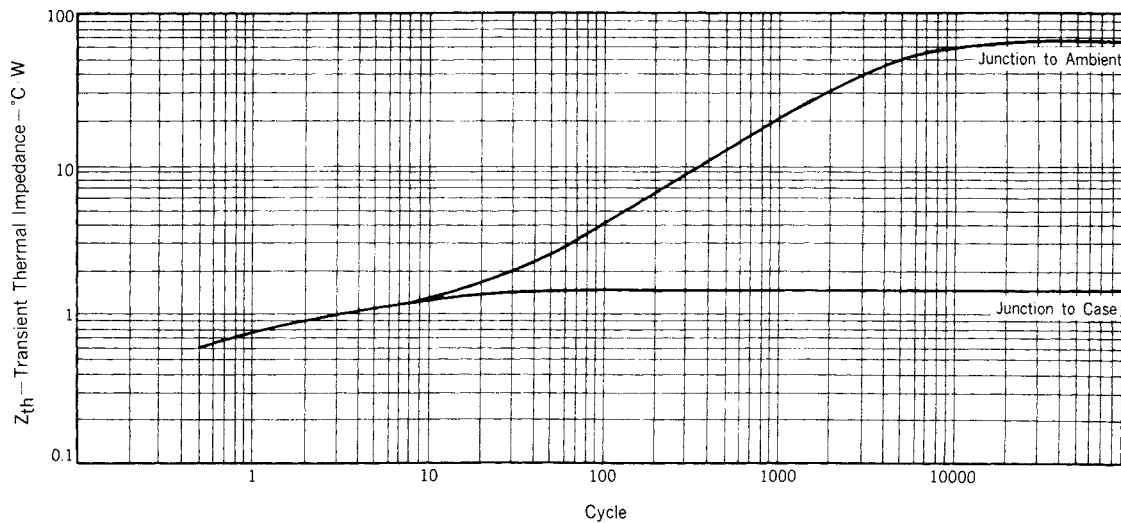

Fig. 13 Z_{th} CHARACTERISTIC



NEC Corporation

INTERNATIONAL ELECTRON DEVICES DIV.
SUMITOMO MITA Building, 37-8,
Shiba Gochome, Minato-ku, Tokyo 108, Japan
Tel: Tokyo 456-3111
Telex Address: NECTOK J22686
Cable Address: NEC TOKYO

SC-1036
OCT.-1-85M
Printed in Japan