

2FI100F(2x100A)

FAST RECOVERY DIODE MODULE

300V,600V / 100A
2 in one-package

FAST RECOVERY DIODE MODULE

■ Features

- Short Reverse Recovery Time
- Variety of Connection Menu
- Insulated Type

■ Applications

- Arc-Welders
- Free-Wheeling Diode
- High Speed Rectifiers

■ Outline Drawings, mm

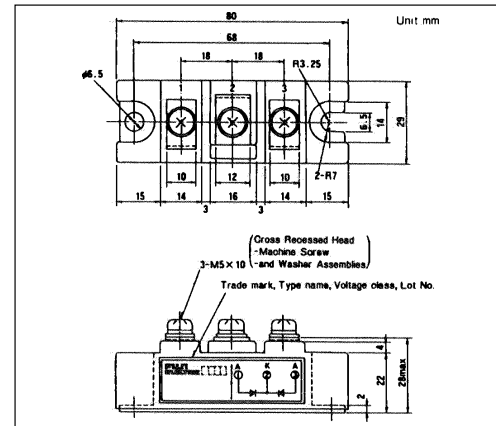

■ Inner Circuit Schematic

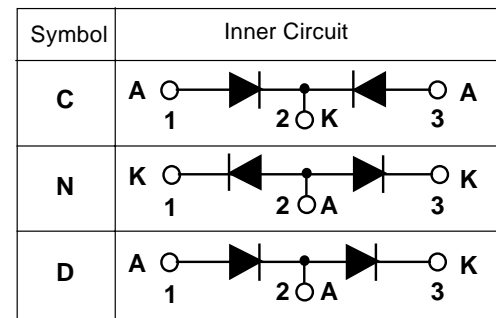

■ Maximum ratings and characteristics

● Absolute maximum ratings

Item	Symbol	Conditions	Rating		Unit
			-030	-060	
Repetitive peak reverse voltage	V_{RRM}		300	600	V
Non-repetitive peak reverse voltage	V_{RSM}		350	650	V
Average output current	$I_{F(AV)}$	50/60Hz Square wave, $T_c=70^\circ\text{C}$	2 x 100		A
Surge current	I_{FSM}	From rated load, Sine wave 10ms	1600		A
I^2t	I^2t	From rated load	10240		A^2s
Operating junction temperature	T_j		-40 to +150		$^\circ\text{C}$
Storage temperature	T_{stg}		-40 to +150		$^\circ\text{C}$
Isolation voltage	V_{is}		AC1500(1min.)		V
Screw torque		(M5)	3.5 *1		N·m

*1: Recommendable value : 2.5 to 3.0 N·m(M5)

●Electrical characteristics ($T_a=25^\circ\text{C}$ Unless otherwise specified)

Item	Symbol	Conditions	Min.	Typ.	Max.	Unit
Forward voltage drop	V_{FM}	$T_j=25^\circ\text{C}$, $I_{FM}=100\text{A}$			1.75	V
Reverse current	I_{RRM}	$T_j=150^\circ\text{C}$, $V_R=V_{RRM}$			60	mA
Reverse recovery time	t_{rr}	$T_j=25^\circ\text{C}$, $I_F=I_R=0.1\text{A}$			0.5	μs

● Thermal Characteristics

Item	Symbol	Conditions	Min.	Typ.	Max.	Unit
Thermal resistance	$R_{th(j-c)}$	Junction to case			0.22	$^\circ\text{C}/\text{W}$
	$R_{th(c-f)}$	the base to cooling fin *			0.10	$^\circ\text{C}/\text{W}$

* : With Thermal Compound

■ Characteristics

Forward Characteristics

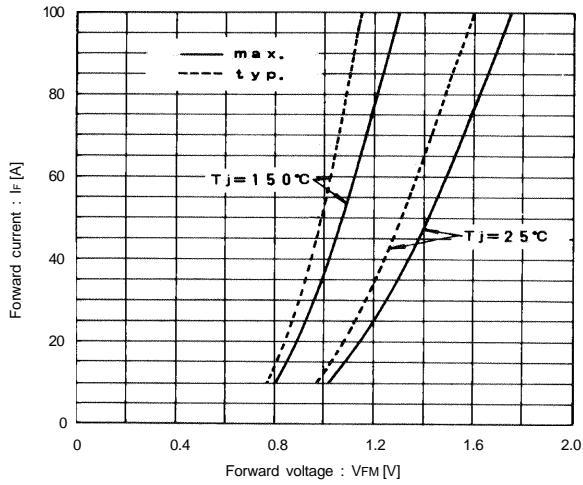

Output Current - Total Loss - Ambient Temperature

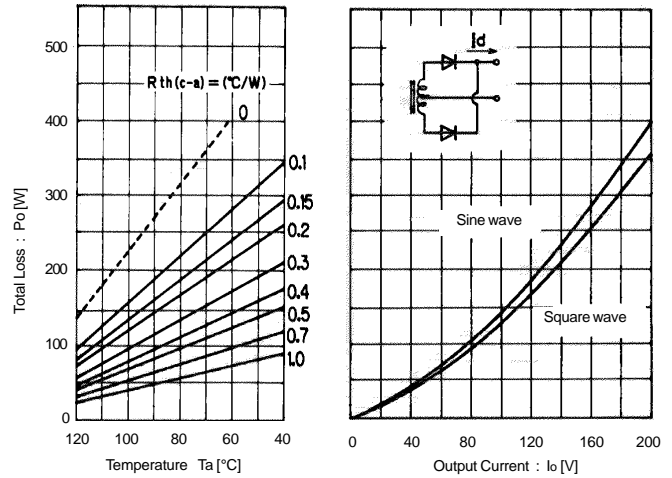

Reverse Recovery Characteristics

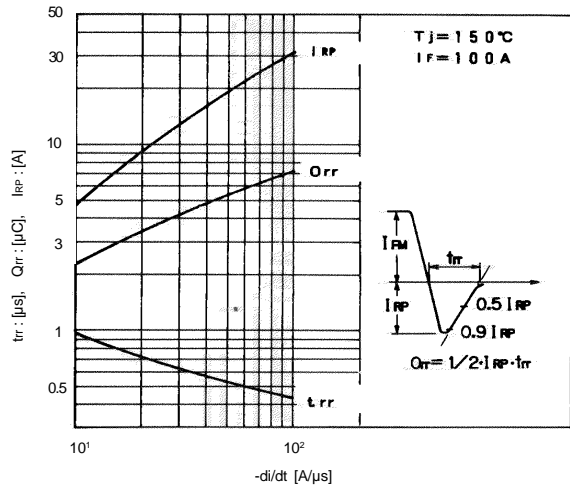

Surge Current

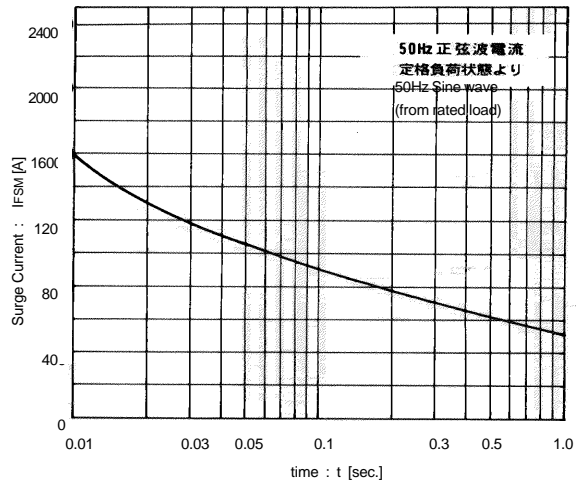

Transient Thermal Impedance

