

SKM 75GB128D



SEMITRANS[®] 2

SPT IGBT Module

SKM 75GB128D

Features

- SPT = Soft-Punch-Through technology
- $V_{CE(sat)}$ with positive temperature coefficient
- High short circuit capability, self limiting to $6 \times I_C$

Typical Applications

- AC inverter drives
- UPS
- Electronic welders at f_{sw} up to 20 kHz

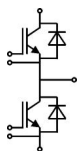

GB

Absolute Maximum Ratings		$T_c = 25^\circ\text{C}$, unless otherwise specified		
Symbol	Conditions	Values	Units	
IGBT				
V_{CES}	$T_j = 25^\circ\text{C}$	1200	V	
I_C	$T_j = 150^\circ\text{C}$	$T_c = 25^\circ\text{C}$	100	A
		$T_c = 80^\circ\text{C}$	70	A
I_{CRM}	$I_{CRM} = 2 \times I_{Cnom}$	100	A	
V_{GES}		± 20	V	
t_{psc}	$V_{CC} = 600\text{ V}; V_{GE} \leq 20\text{ V}; T_j = 125^\circ\text{C}$ $V_{CES} < 1200\text{ V}$	10	μs	
Inverse Diode				
I_F	$T_j = 150^\circ\text{C}$	$T_{case} = 25^\circ\text{C}$	75	A
		$T_{case} = 80^\circ\text{C}$	50	A
I_{FRM}	$I_{FRM} = 2 \times I_{Fnom}$	100	A	
I_{FSM}	$t_p = 10\text{ ms}; \text{sin.}$	$T_j = 150^\circ\text{C}$	550	A
Module				
$I_{t(RMS)}$		200	A	
T_{vj}		- 40...+ 150	$^\circ\text{C}$	
T_{stg}		- 40...+ 125	$^\circ\text{C}$	
V_{isol}	AC, 1 min.	4000	V	

Characteristics		$T_c = 25^\circ\text{C}$, unless otherwise specified			
Symbol	Conditions	min.	typ.	max.	Units
IGBT					
$V_{GE(th)}$	$V_{GE} = V_{CE}, I_C = 2\text{ mA}$	4,5	5,5	6,5	V
I_{CES}	$V_{GE} = 0\text{ V}, V_{CE} = V_{CES}$	$T_j = 25^\circ\text{C}$	0,1	0,3	mA
V_{CE0}		$T_j = 25^\circ\text{C}$	1	1,15	V
		$T_j = 125^\circ\text{C}$	0,9	1,05	V
r_{CE}	$V_{GE} = 15\text{ V}$	$T_j = 25^\circ\text{C}$	18	24	$\text{m}\Omega$
		$T_j = 125^\circ\text{C}$	24	30	$\text{m}\Omega$
$V_{CE(sat)}$	$I_{Cnom} = 50\text{ A}, V_{GE} = 15\text{ V}$	$T_j = 25^\circ\text{C}_{chiplev.}$	1,9	2,35	V
		$T_j = 125^\circ\text{C}_{chiplev.}$	2,1	2,55	V
C_{ies}	$V_{CE} = 25, V_{GE} = 0\text{ V}$	$f = 1\text{ MHz}$	4,5		nF
C_{oes}			0,6		nF
C_{res}			0,55		nF
Q_G	$V_{GE} = -8\text{ V} - +20\text{ V}$		600		nC
R_{Gint}	$T_j = 25^\circ\text{C}$		5		Ω
$t_{d(on)}$	$R_{Gon} = 6\ \Omega$	$V_{CC} = 600\text{ V}$ $I_C = 50\text{ A}$	160		ns
t_r			35		ns
E_{on}			6		mJ
$t_{d(off)}$	$R_{Goff} = 6\ \Omega$	$T_j = 125^\circ\text{C}$ $V_{GE} = \pm 15\text{ V}$	310		ns
t_f			65		ns
E_{off}			8		mJ
$R_{th(j-c)}$	per IGBT			0,3	K/W

SKM 75GB128D

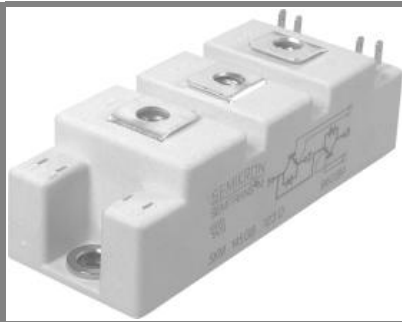

SEMITRANS[®] 2

SPT IGBT Module

SKM 75GB128D

Features

- SPT = Soft-Punch-Through technology
- $V_{CE(sat)}$ with positive temperature coefficient
- High short circuit capability, self limiting to $6 \times I_C$

Typical Applications

- AC inverter drives
- UPS
- Electronic welders at f_{sw} up to 20 kHz

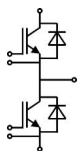

GB

Characteristics

Symbol	Conditions	min.	typ.	max.	Units	
Inverse Diode						
$V_F = V_{EC}$	$I_{Fnom} = 50 \text{ A}; V_{GE} = 0 \text{ V}$		$T_j = 25 \text{ }^\circ\text{C}_{chiplev.}$	2	2,5	V
			$T_j = 125 \text{ }^\circ\text{C}_{chiplev.}$	1,8		V
V_{F0}			$T_j = 25 \text{ }^\circ\text{C}$	1,1	1,2	V
r_F			$T_j = 25 \text{ }^\circ\text{C}$	18	26	m Ω
I_{RRM}	$I_F = 50 \text{ A}$		$T_j = 125 \text{ }^\circ\text{C}$	55		A
Q_{rr}	$di/dt = 2100 \text{ A}/\mu\text{s}$			7,3		μC
E_{rr}	$V_{GE} = -15 \text{ V}; V_{CC} = 600 \text{ V}$			2,6		mJ
$R_{th(j-c)D}$	per diode			0,6		K/W
Module						
L_{CE}				30		nH
R_{CC+EE}	res., terminal-chip		$T_{case} = 25 \text{ }^\circ\text{C}$	0,75		m Ω
			$T_{case} = 125 \text{ }^\circ\text{C}$	1		m Ω
$R_{th(c-s)}$	per module			0,05		K/W
M_s	to heat sink M6			3	5	Nm
M_t	to terminals M5			2,5	5	Nm
w				160		g

This is an electrostatic discharge sensitive device (ESDS), international standard IEC 60747-1, Chapter IX.

This technical information specifies semiconductor devices but promises no characteristics. No warranty or guarantee expressed or implied is made regarding delivery, performance or suitability.

SKM 75GB128D



SEMITRANS[®] 2

SPT IGBT Module

SKM 75GB128D

Features

- SPT = Soft-Punch-Through technology
- $V_{CE(sat)}$ with positive temperature coefficient
- High short circuit capability, self limiting to $6 \times I_C$

Typical Applications

- AC inverter drives
- UPS
- Electronic welders at f_{sw} up to 20 kHz



GB

Z_{th}		Values	Units
Symbol	Conditions		
$Z_{th(j-c)}$			
R_{θ}	$i = 1$	210	mk/W
R_{θ}	$i = 2$	70	mk/W
R_{θ}	$i = 3$	17	mk/W
R_{θ}	$i = 4$	3	mk/W
τ_{θ}	$i = 1$	0,0382	s
τ_{θ}	$i = 2$	0,0242	s
τ_{θ}	$i = 3$	0,0013	s
τ_{θ}	$i = 4$	0,0002	s
$Z_{th(j-c)D}$			
R_{θ}	$i = 1$	400	mk/W
R_{θ}	$i = 2$	160	mk/W
R_{θ}	$i = 3$	35,5	mk/W
R_{θ}	$i = 4$	4,5	mk/W
τ_{θ}	$i = 1$	0,0831	s
τ_{θ}	$i = 2$	0,0063	s
τ_{θ}	$i = 3$	0,0022	s
τ_{θ}	$i = 4$	0,08	s

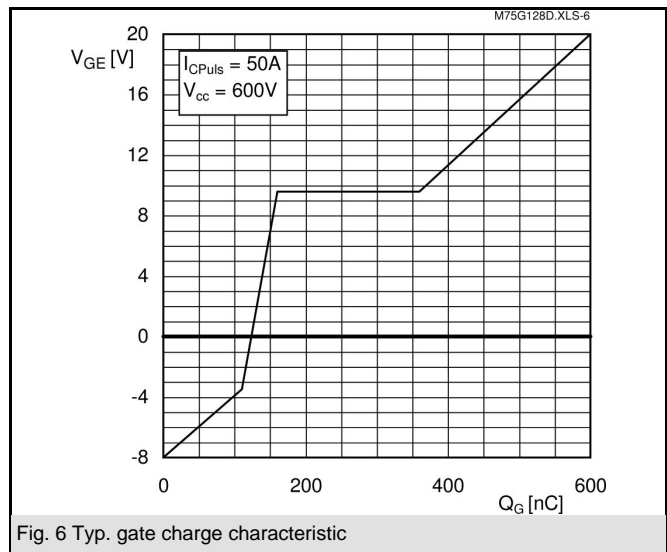
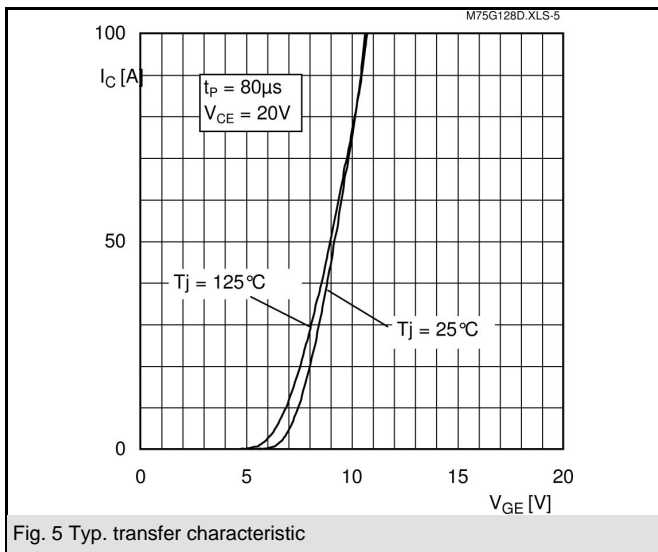
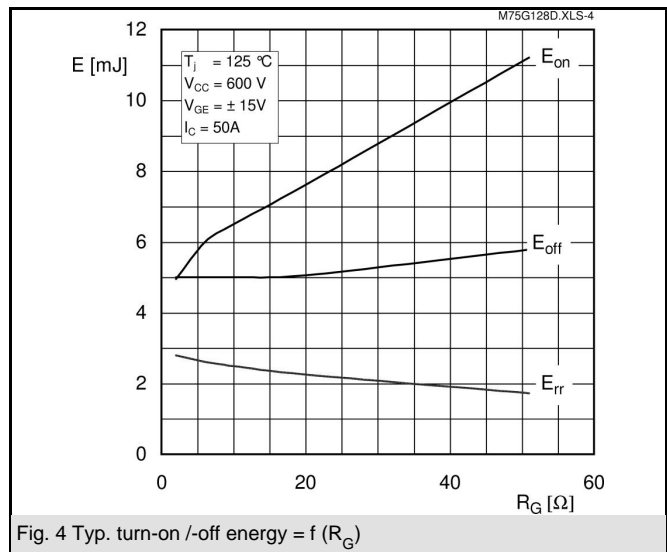
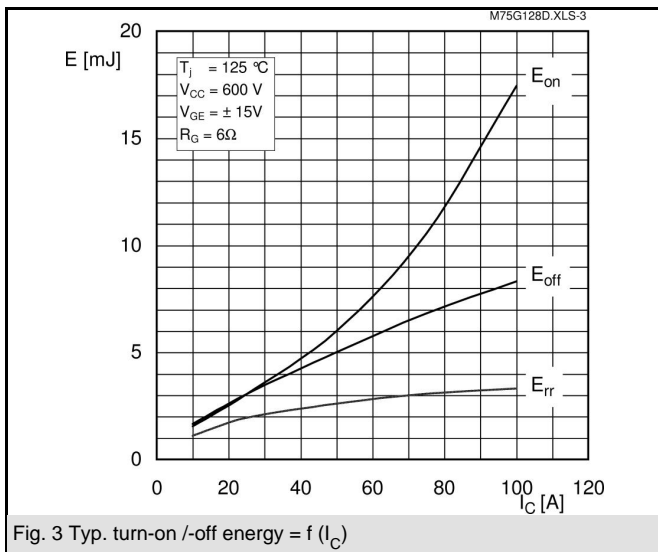
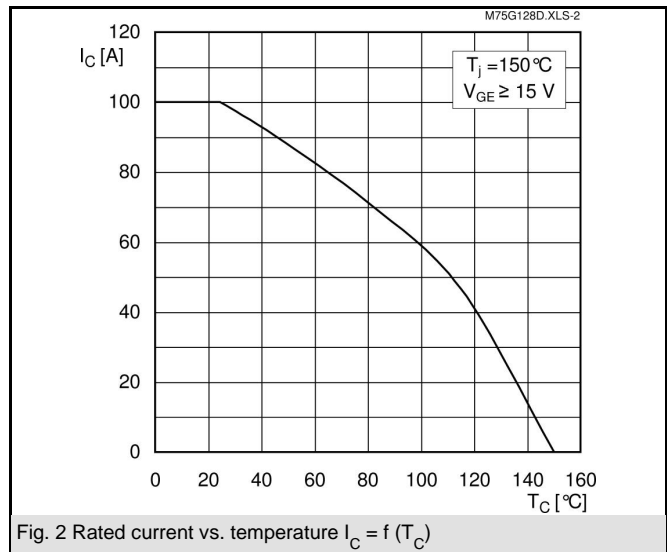
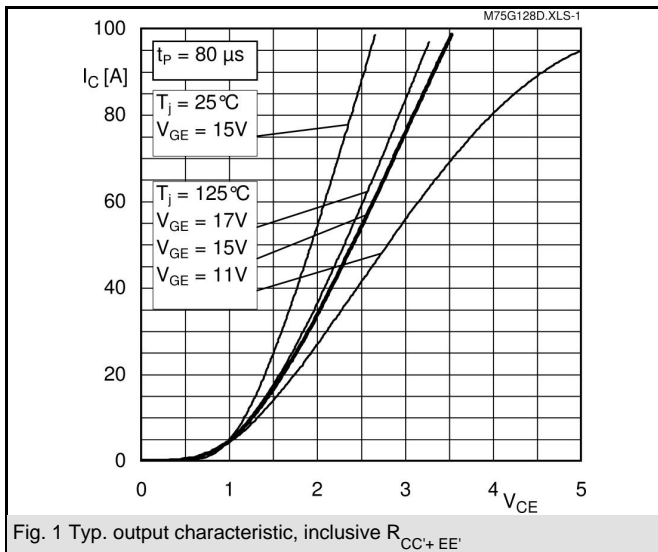

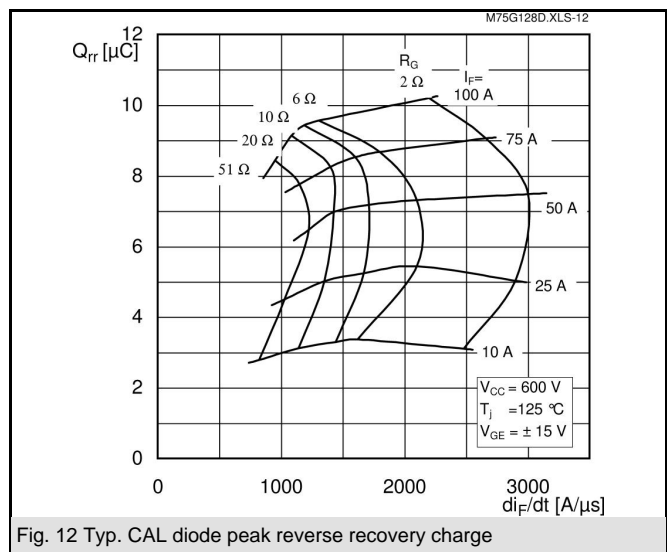
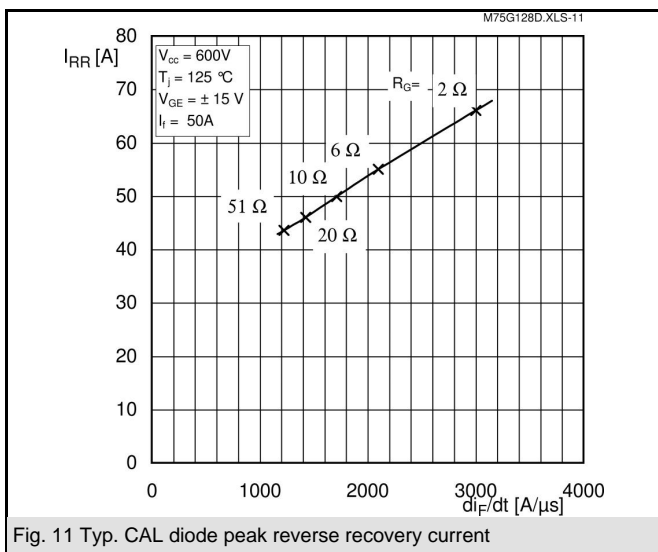
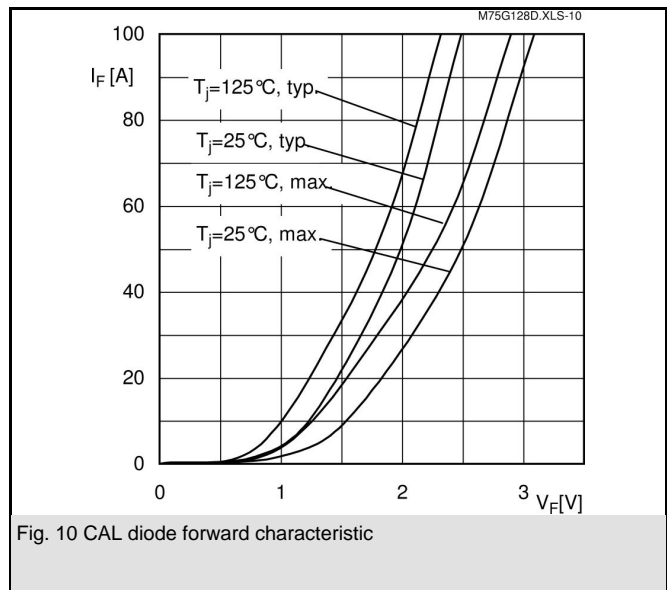
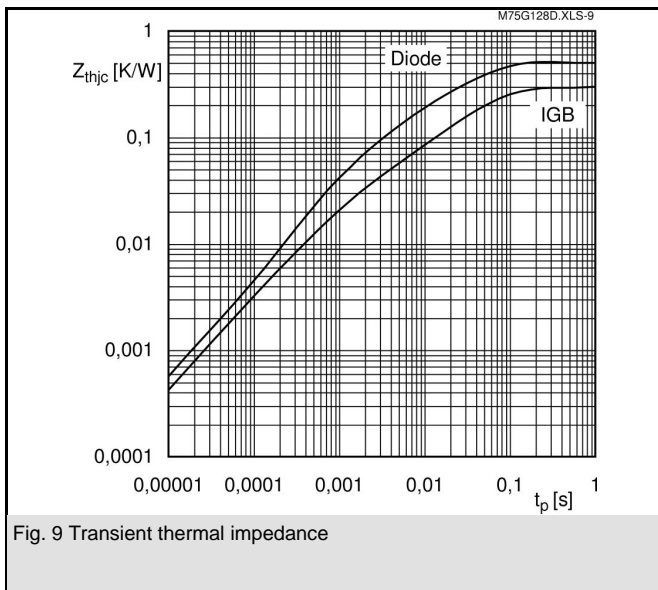
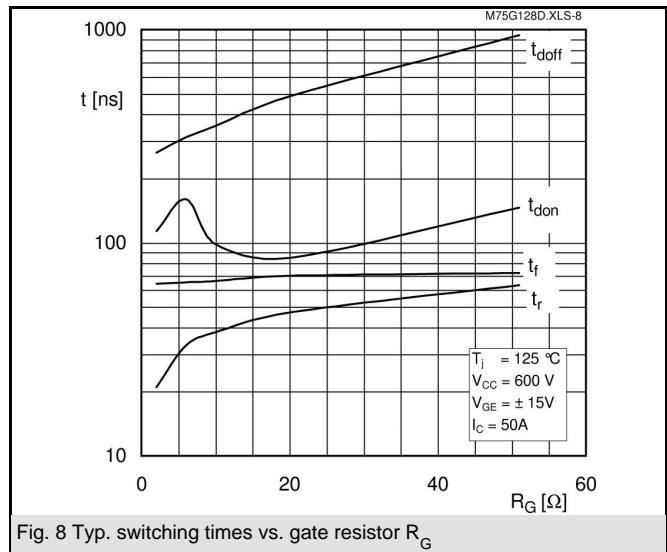
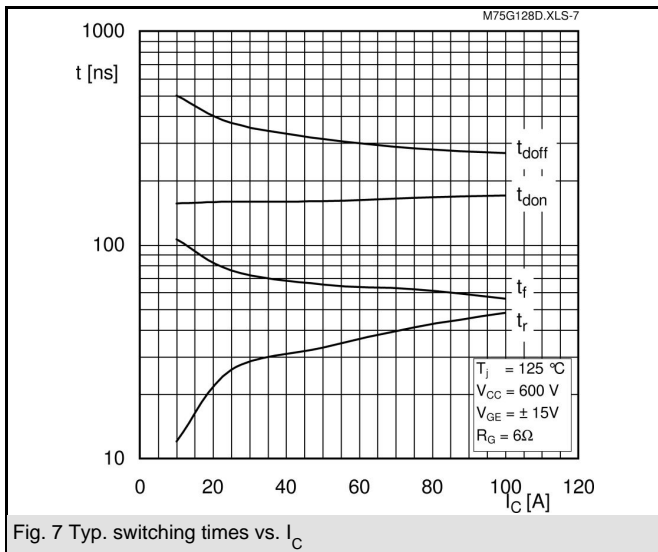

SKM 75GB128D

UL Recognized

CASED61

File no. 63 532

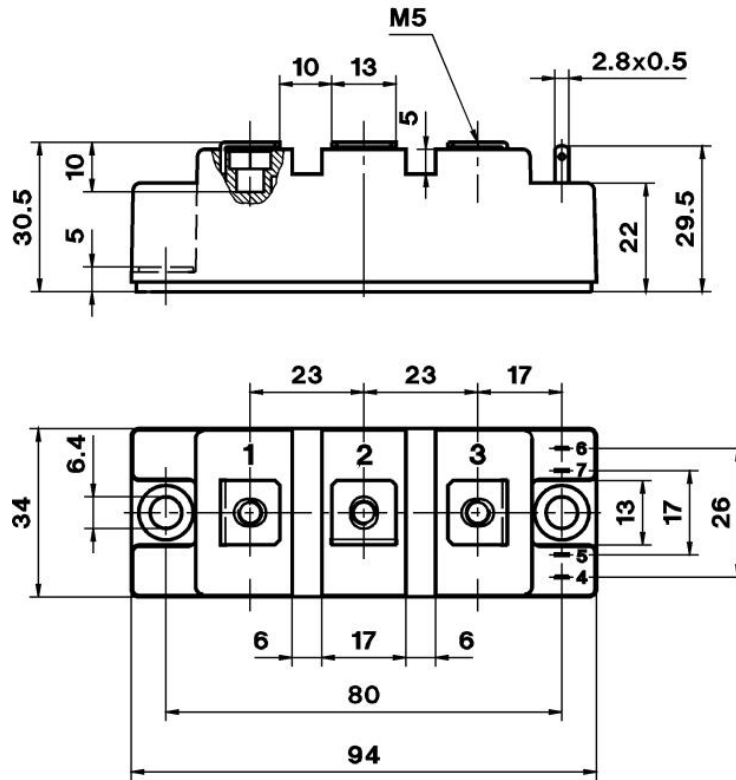

Case D 61

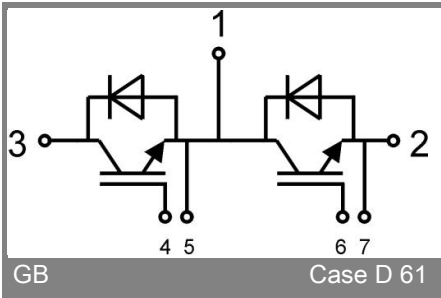

GB

Case D 61