

AEE Low Power High Efficiency

Technical Reference Notes

2.5V, 3.3V, 5V, 12V Single Output

15 watt DC-DC Converter

(Rev01)



Introduction

The AEE low power high efficiency series of DC-DC converters is one of the most cost effective options available in component power. The series uses an industry standard package size and pinout configuration, provides trim functions.

AEE low power high efficiency converters come in 24V or 48V input versions, each of which uses a 2:1 input range; 18V to 36V for the 24Vin versions, and 36V to 75V for the 48Vin versions. Outputs are isolated from input and the converters are capable of providing up to 15 watts of output power.

At start up, input current passes through an input filter designed to help meet CISPR 22 level A radiated emissions, and Bellcore GR1089 conducted emissions. A fault clearing device such as a fuse should be used in line with the input to the module.

The AEE low power high efficiency converters are pulse width modulated (PWM) and operate at a nominal fixed frequency of 300kHz (250kHz for AEE01B48). Feedback to the PWM controller uses an opto-isolator, maintaining complete isolation between primary and secondary. Caution should be taken to avoid ground loops when connecting the converters to ground.

Design Features

- ☞ 2" X 1" package
- ☞ High efficiency
- ☞ High power density
- ☞ 15 watts of output power
- ☞ 2:1 wide input of 18-36V and 36-75V
- ☞ CNT function
- ☞ Trim function
- ☞ Input under-voltage lockout
- ☞ Output short circuit protection
- ☞ Output current limiting
- ☞ Output over-voltage protection
- ☞ High input-output isolation voltage
- ☞ Wide operating case temperature range:
-40°C~ +100°C

Options

- ☞ Choice of TRIM function
- ☞ Choice of CNT function
- ☞ Choice of positive logic or negative logic for CNT function
- ☞ Choice of short pins or long pins

Typical Application

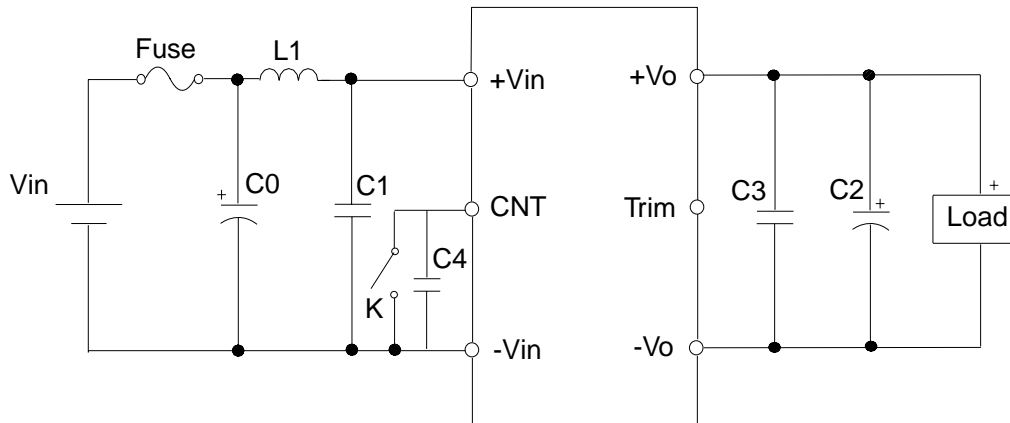

Fuse: 24Vin--2A

48Vin--1A

C0 Recommended:

24Vin--220 μ F/50V electrolytic or ceramic type capacitor

48Vin--220 μ F/100V electrolytic or ceramic type capacitor

C1 Recommended:

$\geq 47\mu$ F/100V capacitor

C2 Recommended:

100 μ F/25V electrolytic or ceramic type capacitor

C3 Recommended:

0.1 μ F/50V capacitor

C4 Recommended:

1000pF capacitor

L1 Recommended:

10--12 μ H

Block Diagram

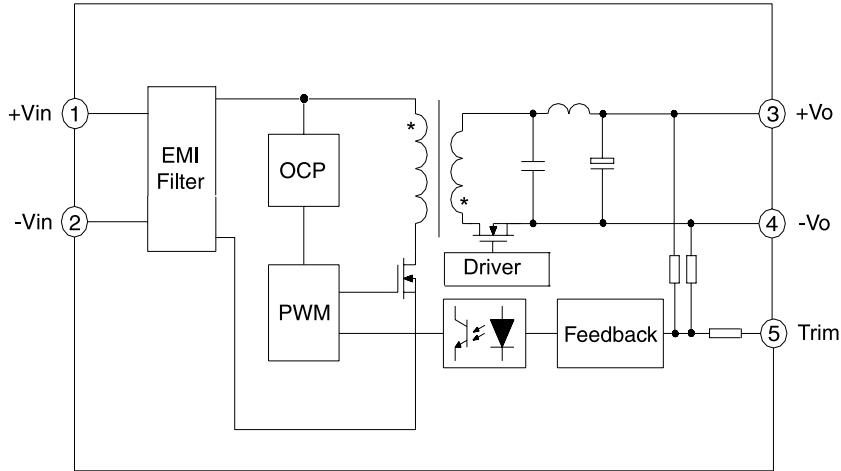

Ordering Information

Model Number	Input Voltage	Output Voltage	Output Current	Ripple (mV rms) typ	Noise (mV pp) typ	Efficiency min	Input Current (A)
AEE04F24-197	18-36V	3.3V	4.5A	15	60	83%	1.0
AEE04G48-197	36-75V	2.5V	4.5A	15	60	80%	0.5
AEE04F48-197	36-75V	3.3V	4.5A	15	60	84%	0.5
AEE04F48-17	36-75V	3.3V	4.5A	15	60	84%	0.5
AEE04F48-7	36-75V	3.3V	4.5A	15	60	84%	0.5
AEE04F48-97	36-75V	3.3V	4.5A	15	60	84%	0.5
AEE03A48-197	36-75V	5V	3A	15	60	85%	0.5
AEE03A48-7	36-75V	5V	3A	15	60	85%	0.5
AEE03A48-97	36-75V	5V	3A	15	60	85%	0.5
AEE03A48-17	36-75V	5V	3A	15	60	85%	0.5
AEE01B48-197	36-75V	12V	1.25A	15	30	85%	0.5
AEE01B48-17	36-75V	12V	1.25A	15	30	85%	0.5
AEE01B48-7	36-75V	12V	1.25A	15	30	85%	0.5
AEE01B48-97	36-75V	12V	1.25A	15	30	85%	0.5

Note: The detailed informatin about model number can refer to the "Part Number Description" at the end of the manual.

USA

TEL: 1-760-930-4600

FAX: 1-760-930-0698

Europe

44-(0)1384-842-211

44-(0)1384-843-355

Asia

852-2437-9662

852-2402-4426

www.astec.com



**AEE Low Power High Efficiency Series DC-DC Converters
18Vdc to 36Vdc & 36Vdc to 75Vdc Input, 15 Watt Output**

Absolute Maximum Rating

Characteristic	Min	Typ	Max	Units	Notes
Input Voltage(continuous) 48V _{in}	-0.3		80	Vdc	100ms non-repetitive 50ms non-repetitive
24V _{in}	-0.3		40	Vdc	
Input Voltage(peak/surge) 48V _{in}	-0.3		100	Vdc	
24V _{in}	-0.3		50	Vdc	
Case temperature*	-40		100	°C	
storage temperature	-55		125	°C	

Input Characteristics

Characteristic	Min	Typ	Max	Units	Notes
Input Voltage Range 48V _{in}	36	48	75	Vdc	With external input filter circuit
24V _{in}	18	24	36	Vdc	
Input Reflected Current		5	10	mA _{p-p}	
Turn-off Input Voltage 48V _{in}	30	33	35	Vdc	
24V _{in}	14	16	17	Vdc	
Turn-on Input Voltage 48V _{in}	31	34	36	Vdc	
24V _{in}	15	17	18	Vdc	
Turn On Time		5	20	ms	

CNT Function

Characteristic	Min	Typ	Max	Units	Notes
Logic High	3		10	Vdc	-0.8mA: -0.7V, 1.5mA: 10V
Logic Low	0		1.2	Vdc	
Control Current	-0.8		1.5	mA	

General Specifications

Characteristic	Min	Typ	Max	Units	Notes
MTBF**		1500		k Hrs	Bellcore TR332, Ta=25°C, Io=Iomax
Isolation	1500			Vdc	
Pin solder temperature			260	°C	wave solder < 10 s
Hand Soldering Time			5	s	iron temperature 425°C
Weight		30		grams	

*: The case temperature for AEE04F24-197 is between -40°C~ 95 °C.

** : The MTBF for 12V output products is 2000 kHrs.

USA

TEL: 1-760-930-4600

Europe

44-(0)1384-842-211

Asia

852-2437-9662



**AEE Low Power High Efficiency Series DC-DC Converters
18Vdc to 36Vdc & 36Vdc to 75Vdc Input, 15 Watt Output**

AEE04F24-197 Output Characteristics

Characteristic	Min	Typ	Max	Units	Notes
Power		15		W	
Output Current		4.5		A	
Output Setpoint Voltage	3.24	3.3	3.36	Vdc	Vin=24V, Io=4.5A
Line Regulation		0.02	0.2	%Vo	Vin=18-36V, Io=4.5A
Load Regulation		0.2	0.5	%Vo	Io=0-4.5A, Vin=24V
Dynamic Response					
50-75% load		2	5	%Vo	Ta=25°C, di/dt =1A/10µs
		100	200	µs	Ta=25°C, di/dt =1A/10µs
50-25% load		2	5	%Vo	Ta=25°C, di/dt =1A/10µs
		100	200	µs	Ta=25°C, di/dt =1A/10µs
Current Limit Threshold	5	5.5	7	A	
Short Circuit Current		6.5		A	
Efficiency	83	85		%	Vin=24V, Io=4.5A, Ta=25°C
Trim Range	90		110	%Vo	
Over Voltage Protection Setpoint	3.8		4.2	V	
Temperature Regulation			0.04	%Vo/°C	
Ripple (rms)		15		mV	(0 to 20MHz Bandwidth)
Noise (p-p)		60		mV	(0 to 20MHz Bandwidth)
Switching Frequency		300		kHz	

USA

TEL: 1-760-930-4600

FAX: 1-760-930-0698

Europe

44-(0)1384-842-211

44-(0)1384-843-355

Asia

852-2437-9662

852-2402-4426

www.astec.com



**AEE Low Power High Efficiency Series DC-DC Converters
18Vdc to 36Vdc & 36Vdc to 75Vdc Input, 15 Watt Output**

AEE04G48-197 Output Characteristics

Characteristic	Min	Typ	Max	Units	Notes
Power		11.25		W	
Output Current		4.5		A	
Output Setpoint Voltage	2.45	2.5	2.55	Vdc	Vin=48V, Io=4.5A
Line Regulation		0.02	0.2	%Vo	Vin=36~75V, Io=4.5A
Load Regulation		0.2	0.5	%Vo	Io=0~4.5A, Vin=48V
Dynamic Response					
50-75% load		2	5	%Vo	Ta=25°C, di/dt =1A/10µs
		100	200	µs	Ta=25°C, di/dt =1A/10µs
50-25% load		2	5	%Vo	Ta=25°C, di/dt =1A/10µs
		100	200	µs	Ta=25°C, di/dt =1A/10µs
Current Limit Threshold	5	5.5	7.5	A	
Short Circuit Current		7.5		A	
Efficiency	80	83		%	Vin=48V, Io=4.5A, Ta=25°C
Trim Range	90		110	%Vo	
Over Voltage Protection Setpoint	2.9		3.5	V	
Temperature Regulation			0.04	%Vo/°C	
Ripple (rms)		15		mV	(0 to 20MHz Bandwidth)
Noise (p-p)		60		mV	(0 to 20MHz Bandwidth)
Switching Frequency		300		kHz	

USA

TEL: 1-760-930-4600

FAX: 1-760-930-0698

Europe

44-(0)1384-842-211

44-(0)1384-843-355

Asia

852-2437-9662

852-2402-4426

www.astec.com



**AEE Low Power High Efficiency Series DC-DC Converters
18Vdc to 36Vdc & 36Vdc to 75Vdc Input, 15 Watt Output**

AEE04F48-197 Output Characteristics

Characteristic	Min	Typ	Max	Units	Notes
Power		15		W	
Output Current		4.5		A	
Output Setpoint Voltage	3.24	3.3	3.36	Vdc	Vin=48V, Io=4.5A
Line Regulation		0.02	0.2	%Vo	Vin=36~75V, Io=4.5A
Load Regulation		0.2	0.5	%Vo	Io=0~4.5A, Vin=48V
Dynamic Response					
50-75% load		2	5	%Vo	Ta=25°C, di/dt =1A/10µs
		100	200	µs	Ta=25°C, di/dt =1A/10µs
50-25% load		2	5	%Vo	Ta=25°C, di/dt =1A/10µs
		100	200	µs	Ta=25°C, di/dt =1A/10µs
Current Limit Threshold	5	5.5	7	A	
Short Circuit Current		6		A	
Efficiency	84	86		%	Vin=48V, Io=4.5A, Ta=25°C
Trim Range	90		110	%Vo	
Over Voltage Protection Setpoint	3.8		4.2	V	
Temperature Regulation			0.04	%Vo/°C	
Ripple (rms)		15		mV	(0 to 20MHz Bandwidth)
Noise (pp)		60		mV	(0 to 20MHz Bandwidth)
Switching Frequency		300		kHz	

USA

TEL: 1-760-930-4600

FAX: 1-760-930-0698

Europe

44-(0)1384-842-211

44-(0)1384-843-355

Asia

852-2437-9662

852-2402-4426

www.astes.com



**AEE Low Power High Efficiency Series DC-DC Converters
18Vdc to 36Vdc & 36Vdc to 75Vdc Input, 15 Watt Output**

AEE03A48-197I-7I-97 Output Characteristics

Characteristic	Min	Typ	Max	Units	Notes
Power		15		W	
Output Current		3		A	
Output Setpoint Voltage	4.95	5	5.05	Vdc	Vin=48V, Io=3A
Line Regulation		0.02	0.2	%Vo	Vin=36~75V, Io=3A
Load Regulation		0.2	0.5	%Vo	Io=0~3A, Vin=48V
Dynamic Response					
50-75% load		2	5	%Vo	Ta=25°C, di/dt =1A/10µs
		100	200	µs	Ta=25°C, di/dt =1A/10µs
50-25% load		2	5	%Vo	Ta=25°C, di/dt =1A/10µs
		100	200	µs	Ta=25°C, di/dt =1A/10µs
Current Limit Threshold	3.8	4.4	5	A	
Short Circuit Current		6		A	
Efficiency	85	87		%	Vin=48V, Io=3A, Ta=25°C
Trim Range	90		110	%Vo	
Over Voltage Protection Setpoint	5.8		6.5	V	
Temperature Regulation			0.04	%Vo/°C	
Ripple (rms)		15		mV	(0 to 20MHz Bandwidth)
Noise (pp)		60		mV	(0 to 20MHz Bandwidth)
Switching Frequency		300		kHz	

USA

TEL: 1-760-930-4600

FAX: 1-760-930-0698

Europe

44-(0)1384-842-211

44-(0)1384-843-355

Asia

852-2437-9662

852-2402-4426

www.astes.com



**AEE Low Power High Efficiency Series DC-DC Converters
18Vdc to 36Vdc & 36Vdc to 75Vdc Input, 15 Watt Output**

AEE01B48-197 Output Characteristics

Characteristic	Min	Typ	Max	Units	Notes
Power		15		W	
Output Current		1.25		A	
Output Setpoint Voltage	11.88	12	12.12	Vdc	Vin=48V, Io=1.25A
Line Regulation		0.02	0.2	%Vo	Vin=36~75V, Io=1.25A
Load Regulation		0.2	0.5	%Vo	Io=0~1.25A, Vin=48V
Dynamic Response					
50-75% load		1	5	%Vo	Ta=25°C, di/dt =1A/50µs
		100	200	µs	Ta=25°C, di/dt =1A/50µs
50-25% load		1	5	%Vo	Ta=25°C, di/dt =1A/50µs
		100	200	µs	Ta=25°C, di/dt =1A/50µs
Current Limit Threshold	1.4	1.6	2.0	A	
Short Circuit Current		3		A	
Efficiency	85	87		%	Vin=48V, Io=1.25A, Ta=25°C
Trim Range	90		110	%Vo	
Over Voltage Protection Setpoint	13.8		15	V	
Temperature Regulation			0.04	%Vo/°C	
Ripple (rms)		10		mV	(0 to 20MHz Bandwidth)
Noise (pp)		30		mV	(0 to 20MHz Bandwidth)
Switching Frequency		250		kHz	

USA

TEL: 1-760-930-4600

FAX: 1-760-930-0698

Europe

44-(0)1384-842-211

44-(0)1384-843-355

Asia

852-2437-9662

852-2402-4426

www.astes.com



Characteristic Curves (at 25 °C)

Typical Efficiency AEE04F24-197

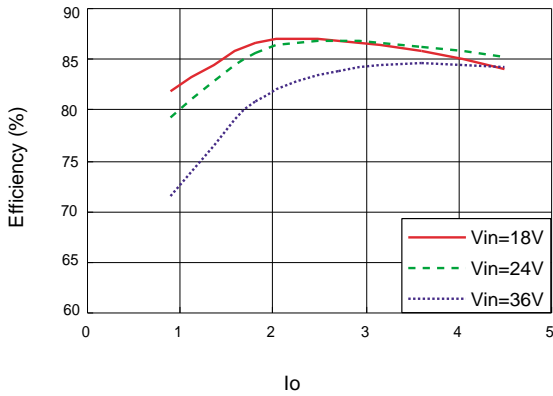

Typical Efficiency AEE04G48-197

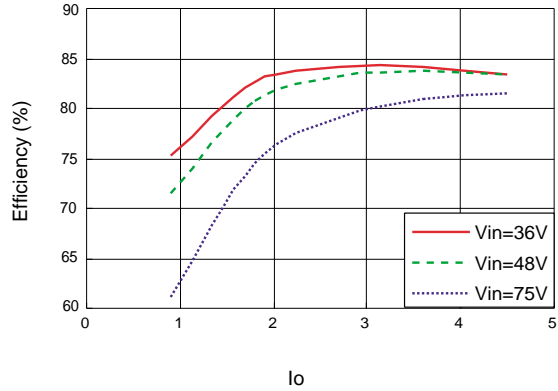

Typical Efficiency AEE04F48-197

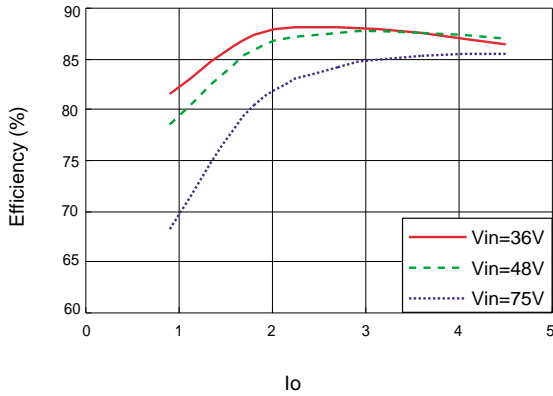

Typical Efficiency AEE03A48-197/-8/-97

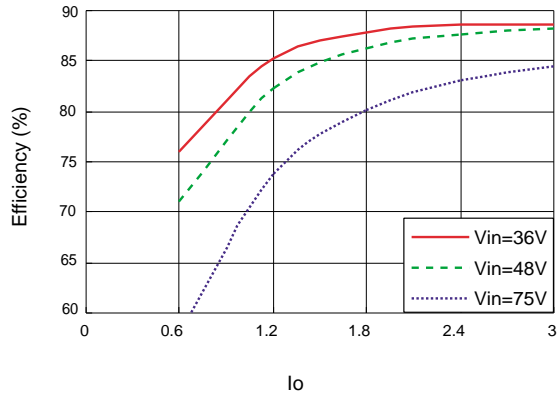

Typical Efficiency AEE01B48-197

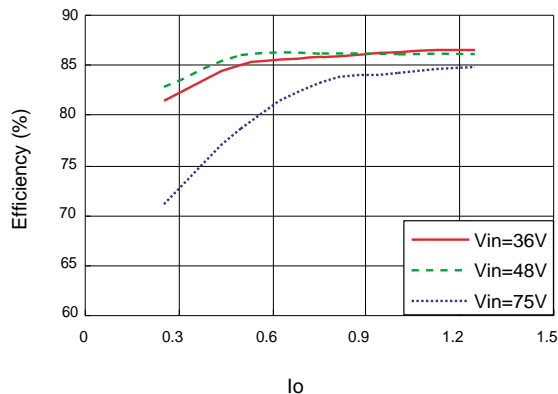

Characteristic Curves (at 25 °C)

**Typical Output Overcurrent Characteristics
AEE04F24-197**

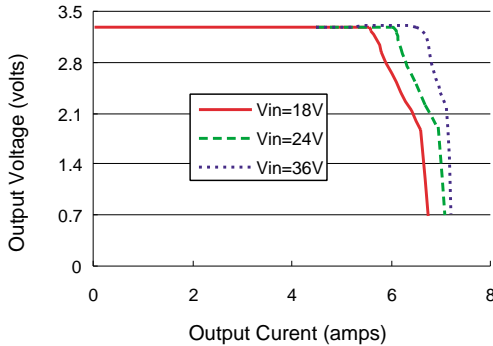

**Typical Output Overcurrent Characteristics
AEE04G48-197**

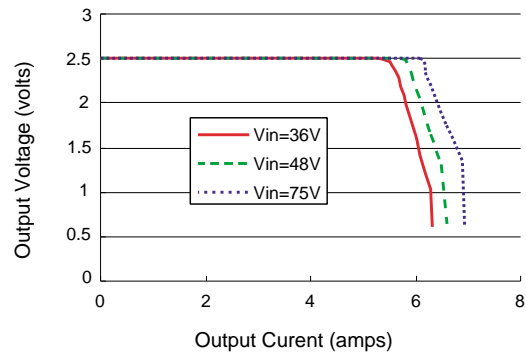

**Typical Output Overcurrent Characteristics
AEE04F48-197**

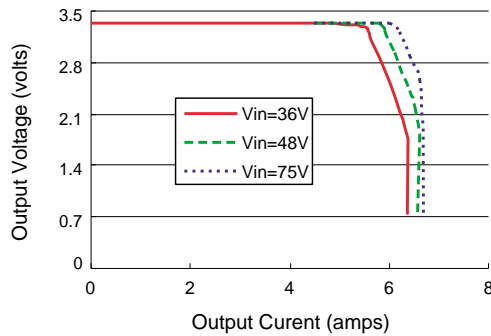

**Typical Output Overcurrent Characteristics
AEE03A48-197/-7/-97**

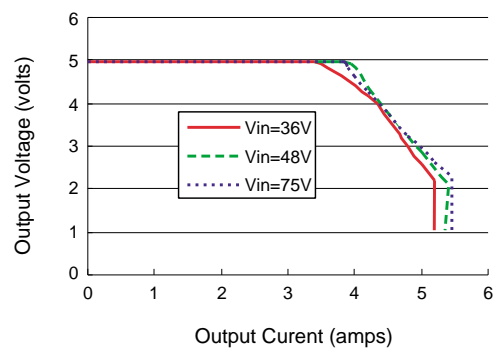

**Typical Output Overcurrent Characteristics
AEE01B48-197**

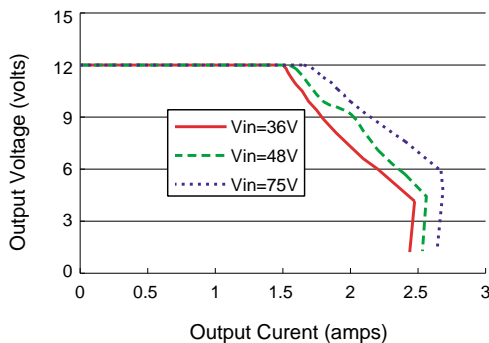

Characteristic Curves (at 25 °C)

Typical Input Current Characteristics
AEE04F24-197

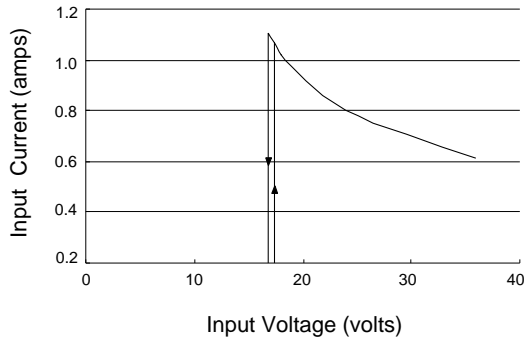

Typical Input Current Characteristics
AEE04F48-197

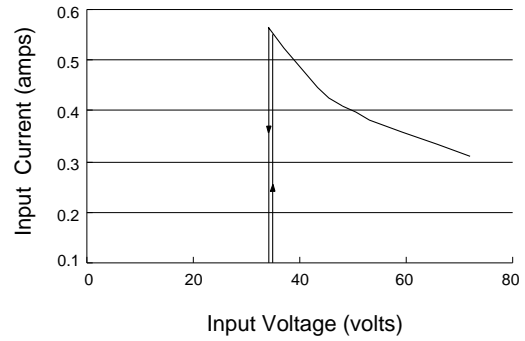

Transient response (rated input voltage, step load, at 25 °C)

**Typical Transient Response to Step Load
 Change from 50%-25%*I*_{omax}
 AEE04F24-197**

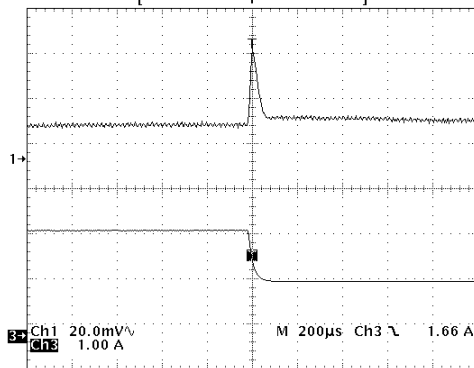

**Typical Transient Response to Step Load
 Change from 50%-25%*I*_{omax}
 AEE04G48-197**

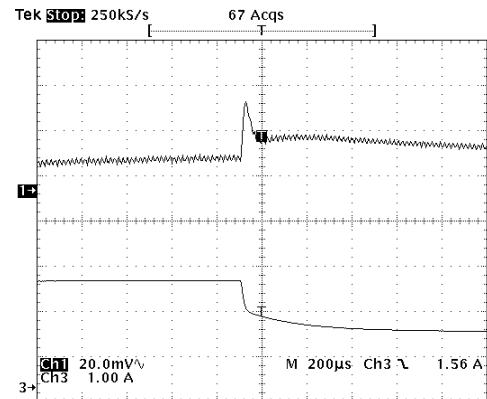

**Typical Transient Response to Step Load
 Change from 50%-25%*I*_{omax}
 AEE04F48-197**

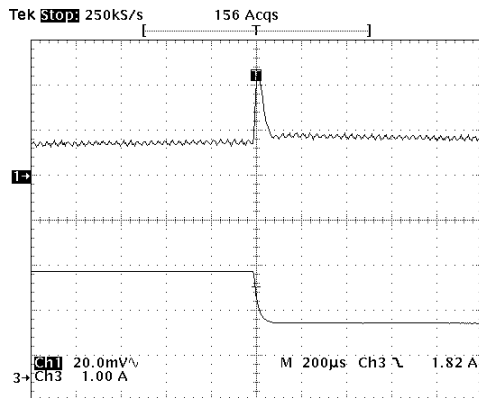

**Typical Transient Response to Step Load
 Change from 50%-25%*I*_{omax}
 AEE03A48-197/-71-97**

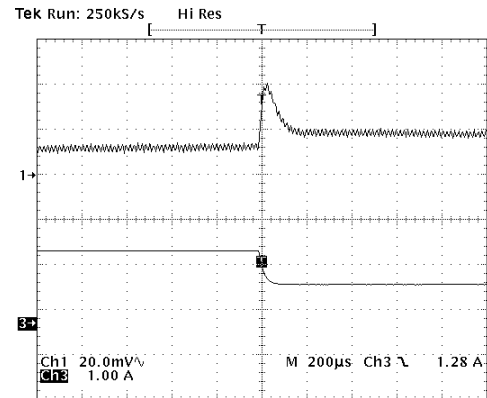

Transient response (rated input voltage, step load, at 25 °C)

**Typical Transient Response to Step Load
Change from 50%-75%I_{omax}
AEE04F24-197**

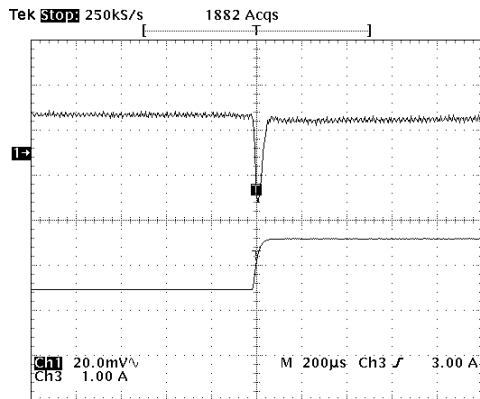

**Typical Transient Response to Step Load
Change from 50%-75%I_{omax}
AEE04G48-197**

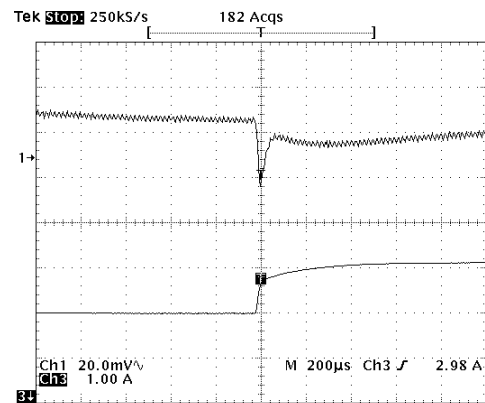

**Typical Transient Response to Step Load
Change from 50%-75%I_{omax}
AEE04F48-197**

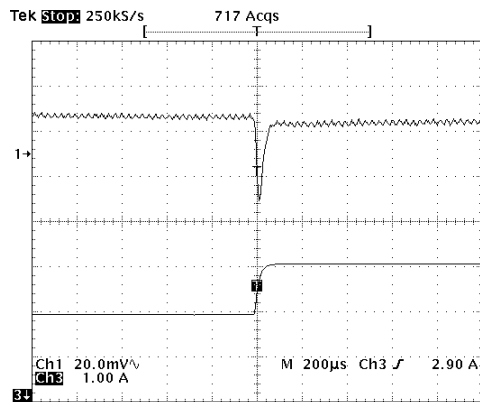

**Typical Transient Response to Step Load
Change from 50%-75%I_{omax}
AEE03A48-197/-7/-97**

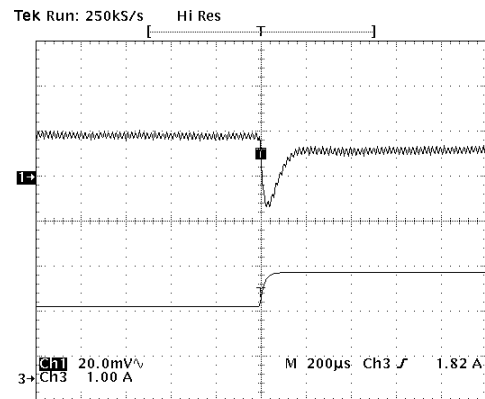

Characteristic Curves *(rated input voltage, full load, at 25 °C)*

Typical Start-Up from Power On
AEE04F24-197

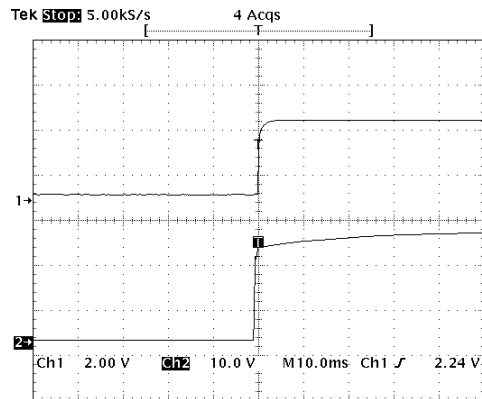

Typical Start-Up from Power On
AEE04G48-197

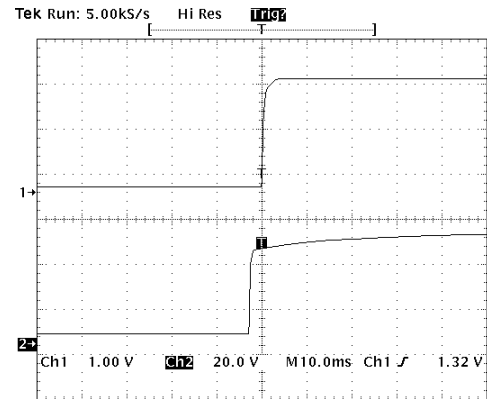

Typical Start-Up from Power On
AEE04F48-197

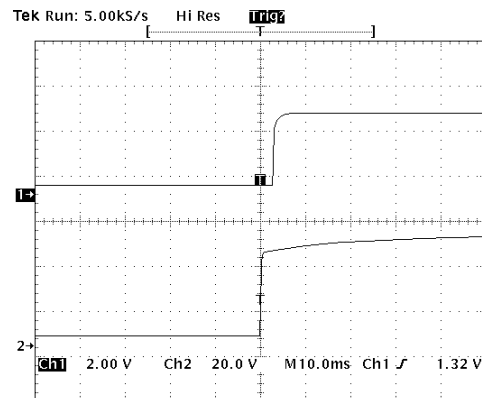

Typical Start-Up from Power On
AEE03A48-197/-7/-97

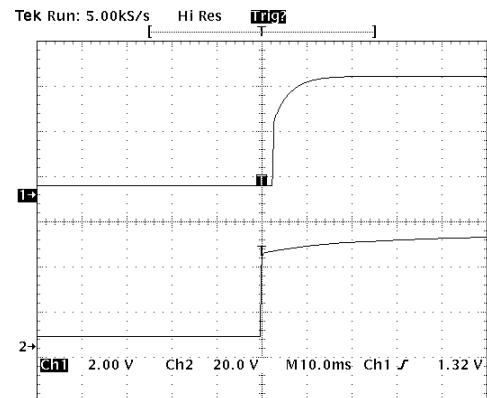

Typical Start-Up from Power On
AEE01B48-197

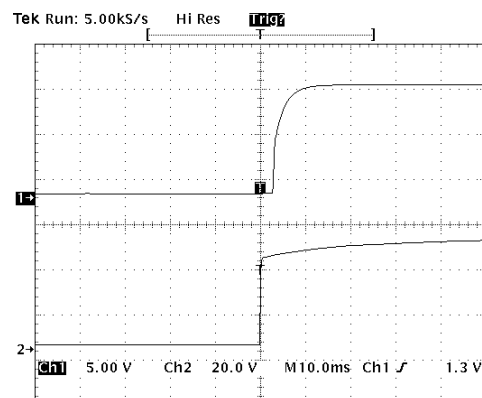

Characteristic Curves *(rated input voltage, full load, at 25 °C)*

Typical Start-Up from CNT Control
 AEE04F24-197

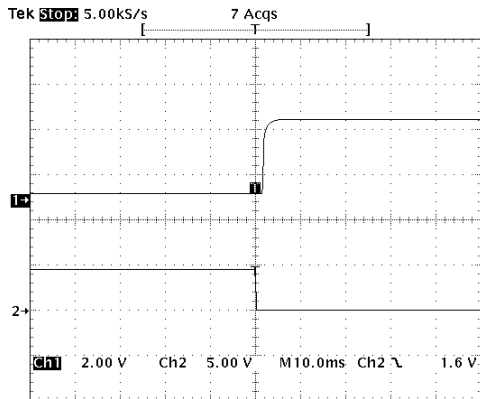

Typical Start-Up from CNT Control
 AEE04G48-197

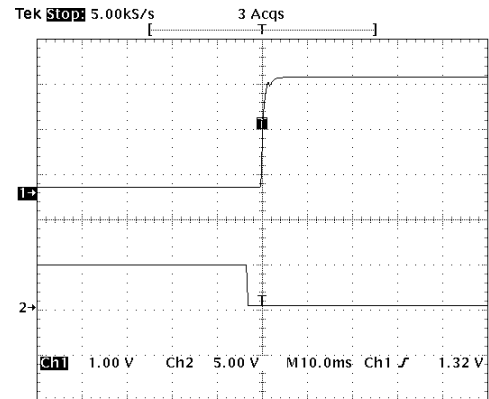

Typical Start-Up from CNT Control
 AEE04F48-197

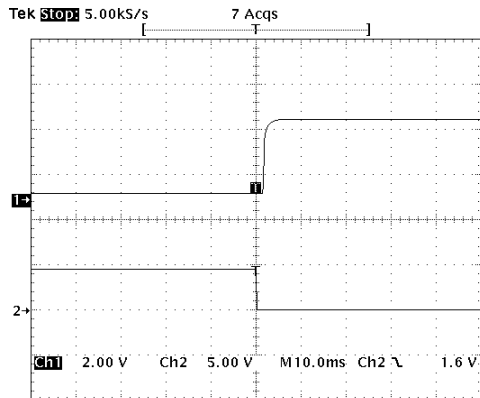

Typical Start-Up from CNT Control
 AEE03A48-197/-7/-97

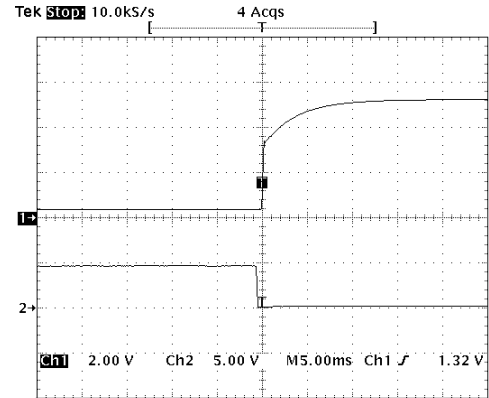

Typical Start-Up from CNT Control
 AEE01B48-197

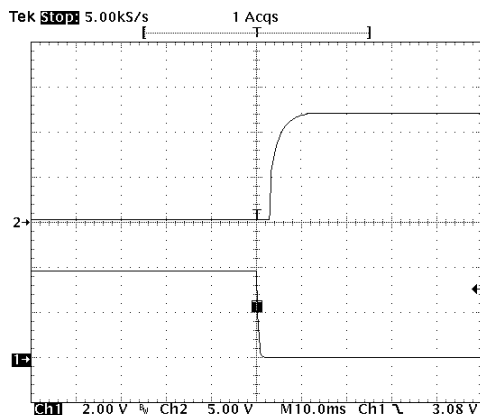

USA

TEL: 1-760-930-4600

Europe

44-(0)1384-842-211

Asia

852-2437-9662



Characteristic Curves *(rated input voltage, full load, at 25 °C)*

Typical Shut-down from CNT Control
AEE04F24-197

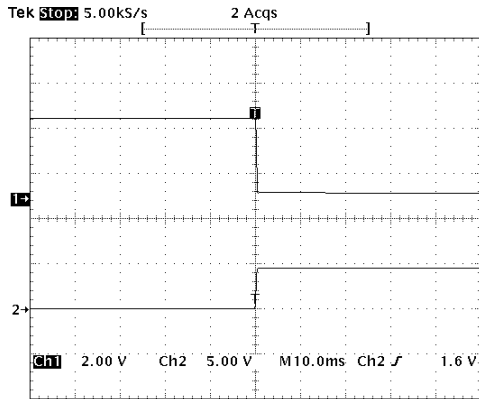

Typical Shut-down from CNT Control
AEE04G48-197

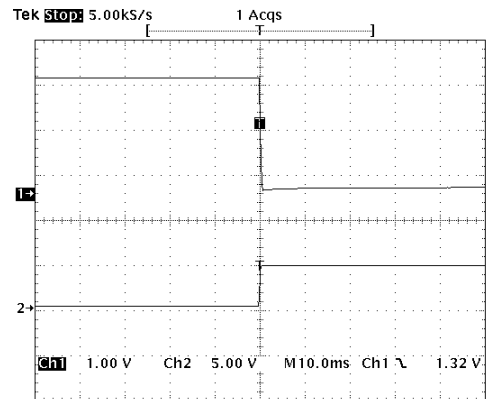

Typical Shut-down from CNT Control
AEE04F48-197

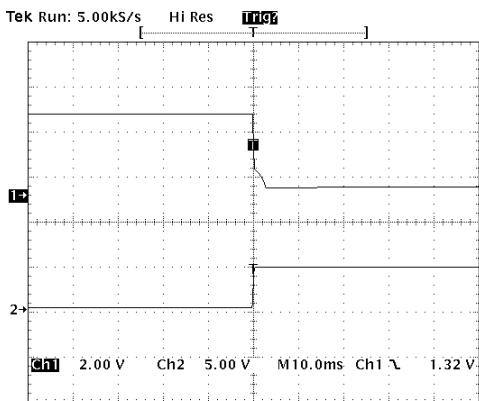

Typical Shut-down from CNT Control
AEE03A48-197/-71-97

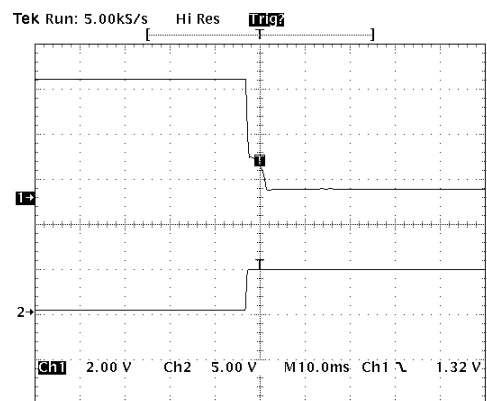

Typical Shut-down from CNT Control
AEE01B48-197

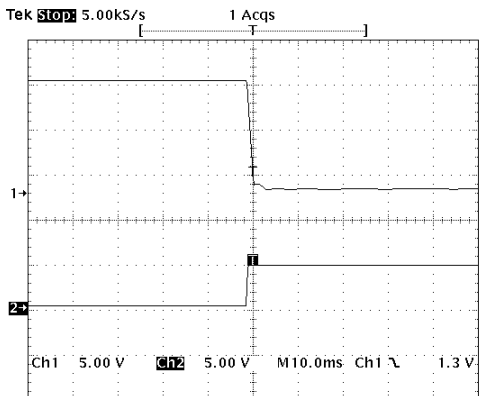

Pin Location

The +Vin and -Vin input connection pins are located as shown in Figure 1. AEE low power high efficiency converters have a 2:1 input voltage range of 18-36V and 36-75V.

Care should be taken to avoid applying reverse polarity to the input which can damage the converter.

pin side view

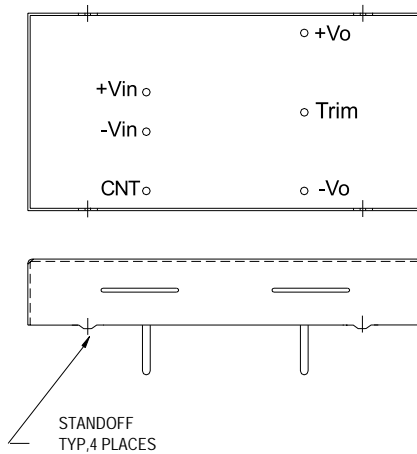

Fig.1 Pin Location

Input Characteristic

Fusing

The AEE low power high efficiency power modules have no internal fuse. An external fuse must always be employed! To meet international safety requirements, a 250 Volt rated fuse should be used. If one of the input lines is connected to chassis ground, then the fuse must be placed in the other input line. Standard safety agency regulations require input fusing. Recommended fuse ratings for AEE low power high efficiency are shown in

Table 1.

Table 1

Series	Fuse Rating
24Vin	2A
48Vin	1A

Input Reverse Voltage Protection

Under installation and cabling conditions where reverse polarity across the input may occur, reverse polarity protection is recommended. Protection can easily be provided as shown in Figure 2. In both cases the diode rating is determined by the power of the converter. Diodes should be rated at 2A for 24Vin, 1A for 48Vin. **Placing the diode across the inputs rather than in-line with the input offers an advantage in that the diode only conducts in a reverse polarity condition, which increases circuit efficiency and thermal performance.**

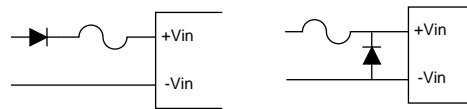

Fig.2 Reverse Polarity Protection Circuits

Input Undervoltage Protection

The AEE low power high efficiency series is protected against undervoltage on the input. If the input voltage drops below the acceptable range, the converter will shut down. It will automatically restart when the undervoltage condition is removed.

Input Filter

Input filters are included in the converters to help achieve standard system emissions certifications. Some users however, may find that additional input filtering is necessary. The AEE low power high efficiency series has an internal switching frequency of 300 kHz (250 kHz for AEE01B48), so a high frequency capacitor mounted close to the input terminals produces the best results. To reduce reflected noise, a π filter can be added to the input as shown in Figure 3. The parameters are referred to the page 3.

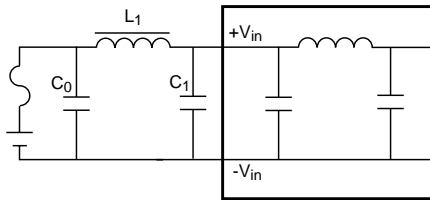

Fig.3 Ripple Rejection Input Filter

For conditions where EMI is a concern, a different input filter can be used. Figure 4 shows an input filter designed to reduce EMI effects. L1 is a 5mH common mode choke.

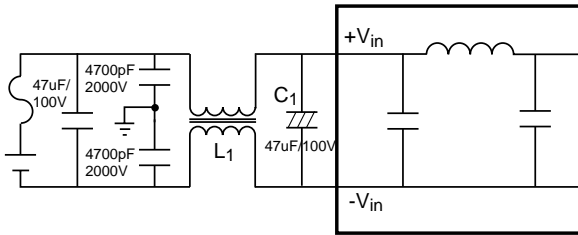

Fig.4 EMI Reduction Input Filter

When a filter inductor is connected in series with the power converter input, an input capacitor C1 should be added. An input capacitor C1 should also be used when the input wiring is long, since the wiring can act as an inductor. Failure to use an input capacitor under these conditions can produce large input voltage spikes and an unstable output.

CNT Function

Two CNT logic options are available. The CNT logic, CNT voltage and the module working state is as the following Table 2.

Table 2

	L	H	Open
N	ON	OFF	OFF
P	OFF	ON	ON

N--- means “Negative Logic”

P--- means “Positive Logic”

L--- means “Low Voltage”, $-0.7V \leq L \leq 1.2V$

H--- means “High Voltage”, $3V \leq H \leq 10V$

ON--- means “module is on”

OFF--- means “module is off”

Open--- means “CNT pin is left open”

Note: The $V_{CNT} \leq 10V$

The following figure 5 to 8 are a few simple CNT control circuits.

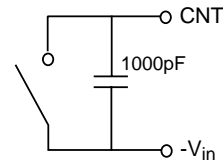

Fig.5 Simple Control

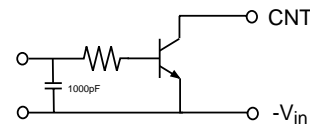

Fig.6 Transistor Control

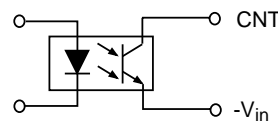

Fig.7 Isolated Control

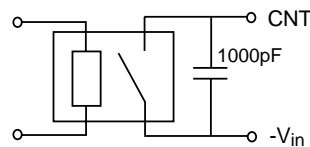

Fig.8 Relay Control

Input-Output Characteristic

Safety Consideration

For safety-agency approval of the system in which the power module is used, the power module must be installed in compliance with the spacing and separation requirements of the end-use safety agency standard, i.e., UL1950, CSA C22.2 No. 950-95, and EN60950. The input-to-output 1500VDC isolation is an operational insulation. The DC/DC power module should be installed in end-use equipment, in compliance with the requirements of the ultimate application, and is intended to be supplied by an isolated secondary circuit. When the supply to the DC/DC power module meets all the requirements for SELV(<60Vdc), the output is considered to remain within SELV limits (level 3). If connected to a 60Vdc power system, double or reinforced insulation must be provided in the power supply that isolates the input from any hazardous voltages, including the ac mains. One Vinut pin and one Voutput pin are to be grounded or both the input and output pins are to be kept floating. Single fault testing in the power supply must be performed in combination with the DC/DC power module to demonstrate that the output meets the requirement for SELV. The input pins of the module are not operator accessible.

Note: Do not ground either of the input pins of the module, without grounding one of the output pins. This may allow a non-SELV voltage to appear between the output pin and ground.

Output Characteristics

Minimum Load Requirements

There no minimum load required for the AEE low power high efficiency series.

Output Trimming

Users can increase or decrease the output voltage set point of a module by connecting an external resistor between the TRIM pin. The trim resistor should be positioned close to the module. **If not using the trim feature, leave the TRIM pin open.**

Trimming up by more than 10% of the nominal output may damage the converter or trig the OVP protection. Trimming down more than 10% can cause the converter to regulate improperly. Trim down and trim up circuits and the corresponding configuration are shown in Figure 9 to Figure 10.

Note that at elevated output voltages the maximum power rating of the module remains the same, and the output current capability will decrease correspondingly.

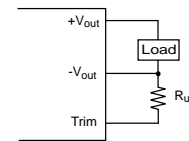

$$3.3V \text{ output: } R_{up} = \frac{0.78}{K} - 6.2 \text{ (K}\Omega\text{)}$$

$$5V \text{ output: } R_{up} = \frac{1.88}{K} - 10 \text{ (K}\Omega\text{)}$$

$$12V \text{ output: } R_{up} = \frac{1.99}{K} - 16 \text{ (K}\Omega\text{)}$$

$$2.5V \text{ output: } R_{up} = \frac{0.62}{K} - 3.9 \text{ (K}\Omega\text{)}$$

$$\text{where } K = \frac{V_o - V_{nom}}{V_{nom}}$$

Fig.9 Circuit Configuration and Equation to Trim Up Output Voltage

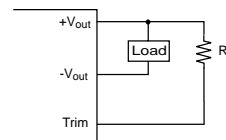

$$3.3V \text{ output: } R_d = \frac{1.27}{K} - 8.25 \text{ (K}\Omega\text{)}$$

$$5V \text{ output: } R_d = \frac{5.63}{K} - 17.5 \text{ (K}\Omega\text{)}$$

$$12V \text{ output: } R_d = \frac{7.54}{K} - 25.53 \text{ (K}\Omega\text{)}$$

$$2.5V \text{ output: } R_d = \frac{0.62}{K} - 5.14 \text{ (K}\Omega\text{)}$$

$$\text{where } K = \frac{V_{nom} - V_o}{V_{nom}}$$

Fig.10 Circuit Configuration and Equation to Trim Down Output Voltage

Output Over-Current Protection

AEE low power high efficiency series DC/DC converters feature foldback current limiting as part of their Overcurrent Protection (OCP) circuits. When output current exceeds 110 to 140% of rated current, such as during a short circuit condition, the module will work on intermittent mode, also can tolerate short circuit conditions indefinitely. When the overcurrent condition is removed, the converter will automatically restart.

Output Filters

When the load is sensitive to ripple and noise, an output filter can be added to minimize the effects. A simple output filter to reduce output ripple and noise can be made by connecting a capacitor C2 across the output as shown in Figure 11. The recommended value for the output capacitor C2 is 100 μ F/25V.

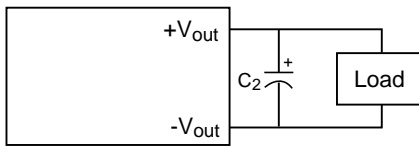

Fig.11 Output Ripple Filter

Extra care should be taken when long leads or traces are used to provide power to the load. Long lead lengths increase the chance for noise to appear on the lines. Under these conditions C2 can be added across the load, with a 0.1 μ F/50V ceramic capacitor C3 in parallel generally as shown in Figure 12.

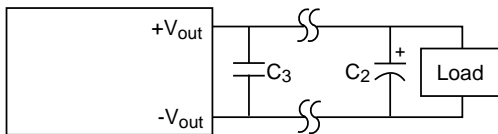

Fig.12 Output Ripple Filter For a Distant Load

Decoupling

Noise on the power distribution system is not always created by the converter. High speed analog or digital loads with dynamic power demands can cause noise to cross the power inductor back onto the input lines. Noise can be reduced by decoupling the load. In most cases, connecting a 10 μ F tantalum capacitor in parallel with a 0.1 μ F ceramic capacitor across the load will decouple it. The capacitors should be connected as close to the load as possible.

Ground Loops

Ground loops occur when different circuits are given multiple paths to common or earth ground, as shown in Figure 13. Multiple ground points can slightly different potential and cause current flow through the circuit from one point to another. This can result in additional noise in all the circuits. To eliminate the problem, circuits should be designed with a single ground connection as shown in Figure 14.

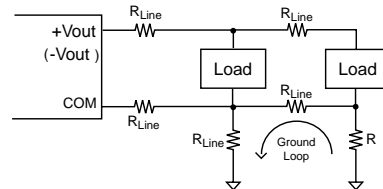

Fig.13 Ground Loops

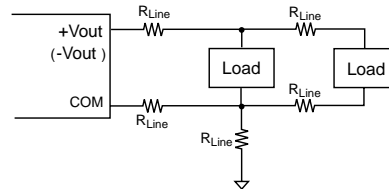

Fig.14 Single Point Ground

Output Over-Voltage Protection

The over-voltage protection has a separate feedback loop which activates when the output voltage is between 120% and 140% of the nominal output voltage.

Parallel Power Distribution

Figure 15 shows a typical parallel power distribution design. Such designs, sometimes called daisy chains, can be used for very low output currents, but are not normally recommended. The voltage across loads far from the source can vary greatly depending on the IR drops along the leads and changes in the loads closer to the source. Dynamic load conditions increase the potential problems.

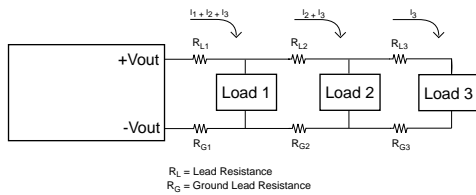

Fig.15 Parallel Power Distribution

Radial Power Distribution

Radial power distribution is the preferred method of providing power to the load. Figure 16. shows how individual loads are connected directly to the power source. This arrangement requires additional power leads, but it avoids the voltage variation problems associated with the parallel power distribution technique.

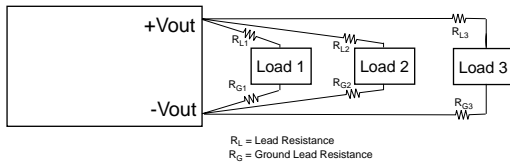

Fig.16 Radial Power Distribution

Mixed Distribution

In the real world a combination of parallel and radial power distribution is often used. Dynamic and high current loads are connected using a radial design, while static and low current loads can be connected in parallel. This combined approach minimizes the drawbacks of a parallel

design when a purely radial design is not feasible.

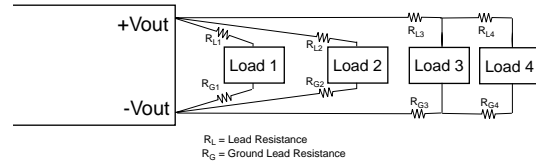

Fig.17 Mixed Power Distribution

Redundant Operation

A common requirement in high reliability systems is to provide redundant power supplies. The easiest way to do this is to place two converters in parallel, providing fault tolerance but not load sharing. Oring diodes should be used to ensure that failure of one converter will not cause failure of the second. Figure 18 shows such an arrangement. Upon application of power, one of the converters will provide a slightly higher output voltage and will support the full load demand. The second converter will see a zero load condition and will “idle”. If the first converter should fail, the second converter will support the full load. When designing redundant converter circuits, Schottky diodes should be used to minimize the forward voltage drop. The voltage drop across the Schottky diodes must also be considered when determining load voltage requirements.

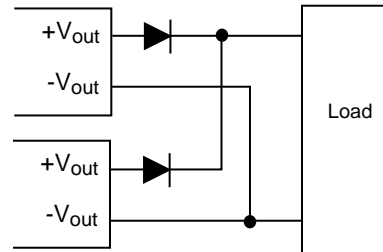
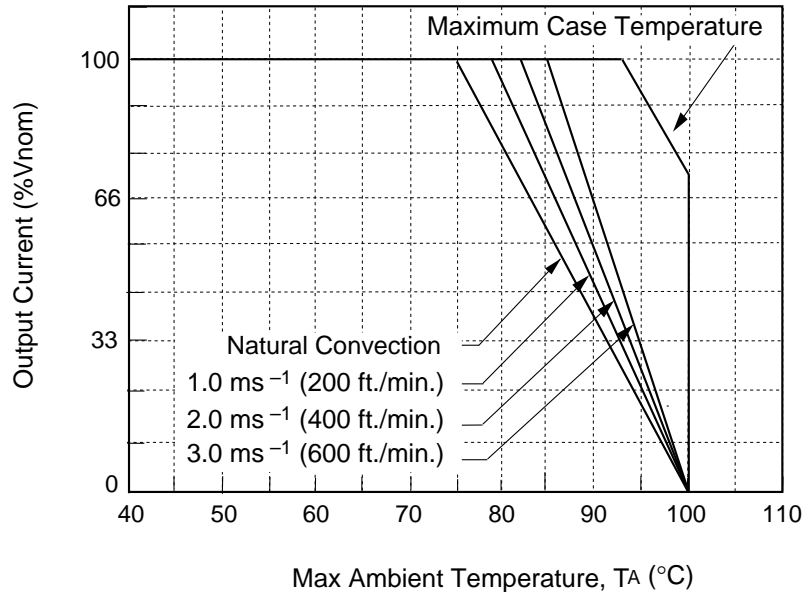

Fig.18 Redundant Operation

Module Derating

Typical Derating Curves

Forced Convection Power Derating



AEE low power high efficiency Series Mechanical Considerations

Installation

Although AEE low power high efficiency series can be mounted in any orientation, free air-flowing must be taken. Normally power components are always put at the end of the airflow path or have the separate airflow paths. This can keep other system equipment cooler and increase component life spans.

Soldering

AEE low power high efficiency series are compatible with standard wave soldering techniques. When wave soldering, the converter pins should be preheated for 20-30 seconds at 110°C, and wave soldered at 260°C for less than 10 seconds.

When hand soldering, the iron temperature should be maintained at 425°C and applied to the converter pins for less than 5 seconds. Longer exposure can cause internal damage to the converter. Cleaning can be performed with cleaning solvent IPA or with water.

MTBF

The MTBF, calculated in accordance with Bellcore TR-NWT-000332 is 1,500,000 hours. Obtaining this MTBF in practice is entirely possible. If the ambient air temperature is expected to exceed +25°C, then we also advise an oriented for the best possible cooling in the air stream.

ASTECC can supply replacements for converters from other manufacturers, or offer custom solutions. Please contact the company for details.

Mechanical Chart *(pin side view)*

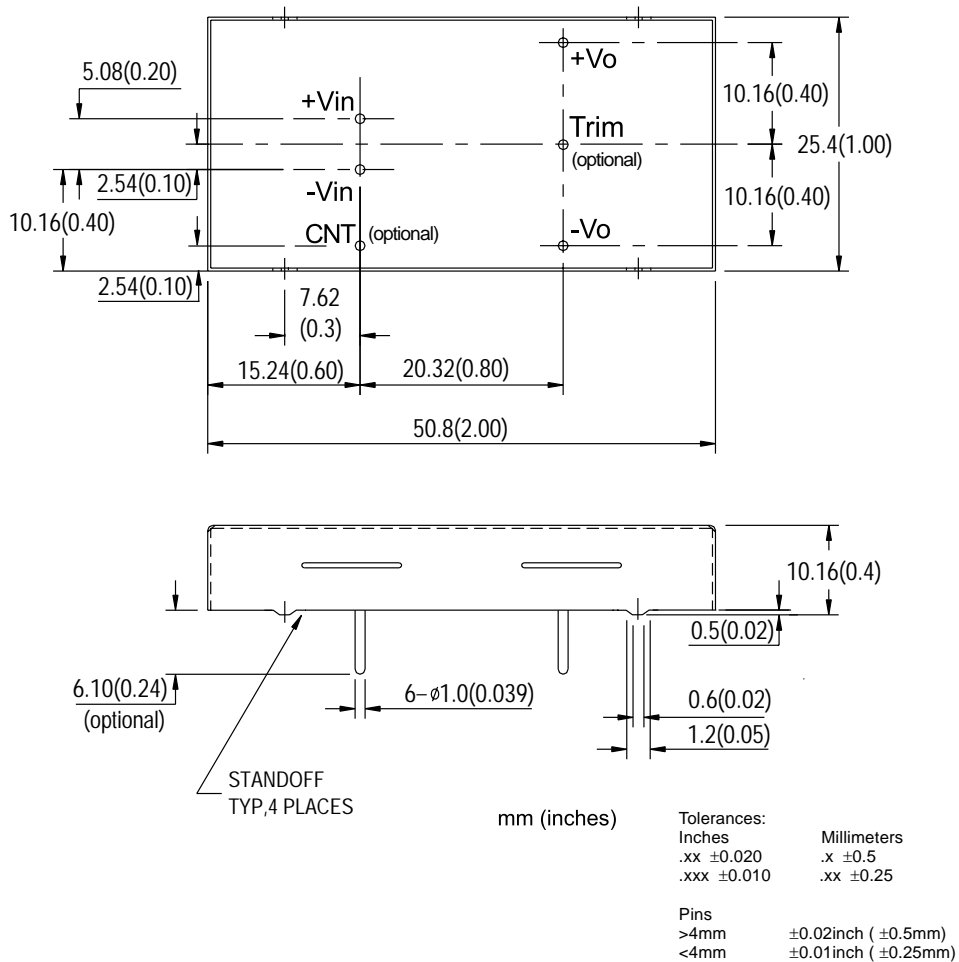

**AEE Low Power High Efficiency Series DC-DC Converters
18Vdc to 36Vdc & 36Vdc to 75Vdc Input, 15 Watt Output**

USA

TEL: 1-760-930-4600

FAX: 1-760-930-0698

Europe

44-(0)1384-842-211

44-(0)1384-843-355

Asia

852-2437-9662

852-2402-4426

www.astes.com

