

PAH SERIES

Single / Dual Output 50-450W

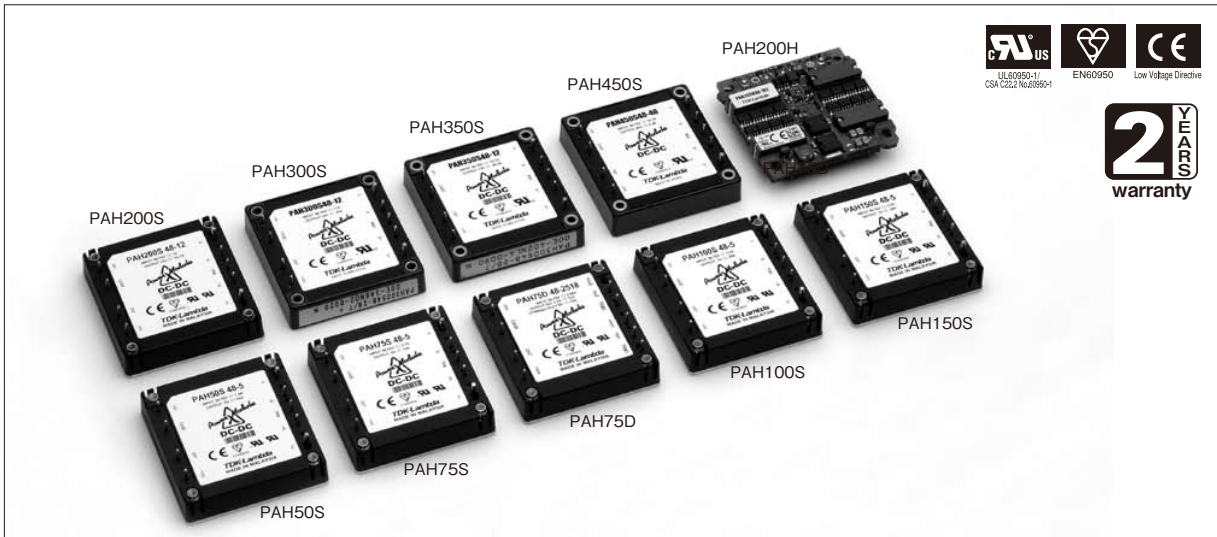

Features

- Half brick industry standard size (61×12.7×57.9 mm)
- High power density (industry-leading level in 450W full brick model)
- High efficiency: 92% (PAH450S48)
- Wide range of operating temperatures (Baseplate temperature: -40 to +100°C except PAH 200H)
- Wide variation
- Built-in capacitor: Ceramic capacitor only (high reliability)
(Organic polymer semiconductor capacitor is also used for output smoothing in PAH200H/PAH75D.)

Model naming method

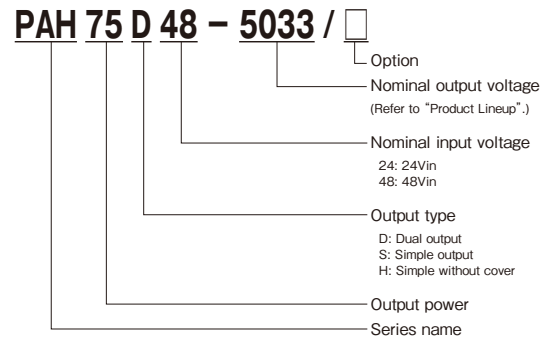

PAH

Applications



Conformity to RoHS Directive

This means that, in conformity with EU Directive 2002/95/EC, lead, cadmium, mercury, hexavalent chromium, and specific bromine-based flame retardants, PBB and PBDE, have not been used, except for exempted applications.

Product Line up

PAH-S24 (DC24Vin)				PAH-S48 (DC48Vin) ①							
Output Voltage	300W		350W		300W		350W		450W		
	Output Current	Model	Output Current	Model	Output Current	Model	Output Current	Model	Output Current	Model	
12V	25A	PAH300S24-12	—	—	25A	PAH300S48-12	29.2A	PAH350S48-12	—	—	
28V	11A	PAH300S24-28	12.5A	PAH350S24-28	11A	PAH300S48-28	12.5A	PAH350S48-28	16A	PAH450S48-28	
48V	—	—	—	—	—	—	—	—	4.9A	PAH450S48-48	

PAH-S48 (DC48Vin) ②										
Output Voltage	50W		75W		100W		150W		200W	
	Output Current	Model	Output Current	Model	Output Current	Model	Output Current	Model	Output Current	Model
1.2V	—	—	—	—	—	—	—	—	70A	PAH200H48-1R2
1.5V	—	—	—	—	—	—	—	—	70A	PAH200H48-1R5
1.8V	—	—	—	—	—	—	—	—	70A	PAH200H48-1R8
2.5V	11.7A	PAH50S48-2.5	17.5A	PAH75S48-2.5	23.4A	PAH100S48-2.5	35A	PAH150S48-2.5	70A	PAH200H48-2R5
3.3V	11.7A	PAH50S48-3.3	17.5A	PAH75S48-3.3	23.4A	PAH100S48-3.3	35A	PAH150S48-3.3	60A	PAH200H48-3R3
5V	10.0A	PAH50S48-5	15.0A	PAH75S48-5	20.0A	PAH100S48-5	30A	PAH150S48-5	—	—
12V	4.2A	PAH50S48-12	6.3A	PAH75S48-12	8.4A	PAH100S48-12	12.5A	PAH150S48-12	16.7A	PAH200S48-12
15V	3.4A	PAH50S48-15	5A	PAH75S48-15	6.7A	PAH100S48-15	10A	PAH150S48-15	13.4A	PAH200S48-15
24V	2.1A	PAH50S48-24	3.2A	PAH75S48-24	4.2A	PAH100S48-24	6.3A	PAH150S48-24	8.4A	PAH200S48-24
28V	1.8A	PAH50S48-28	2.7A	PAH75S48-28	3.6A	PAH100S48-28	5.4A	PAH150S48-28	7.2A	PAH200S48-28
48V	—	—	—	—	—	—	3.2A	PAH150S48-48	—	—

*) PAH200H Serie is without cover.

PAH75D (Dual Output)										
Output Voltage	75W									
	Output Current / Model		Output Current / Model		Output Current / Model		Output Current / Model		Output Current / Model	
1.8V	—	—	—	—	15.0A	—	15.0A	—	—	—
2.5V	15A	—	—	—	15.0A	—	—	—	—	—
3.3V	15A	PAH75D24-3325	15A	PAH75D24-5033	—	—	15.0A	PAH75D48-3118	15.0A	PAH75D48-3325
5V	—	—	15A	—	—	—	—	—	15.0A	PAH75D48-5033

* All specifications are subject to change without notice.

PAH300S24 Specifications

ITEMS/UNITS		MODEL	PAH300S24-12	PAH300S24-28
Input	Voltage Range	V	18 - 36VDC	
	Efficiency (typ) (*1)	%	87	88
	Current (typ) (*2)	A	14.71	15.10
Output	Nominal Voltage	VDC	12	28
	Maximum Current	A	25	11
	Maximum Power	W	300	308
	Voltage Setting Accuracy (*2)	%	±1	
	Maximum Line Regulation (*3)	mV	24	56
	Maximum Load Regulation (*4)	mV	24	56
	Temperature Coefficient		0.02%/°C	
	Maximum Ripple & Noise (*10)	mVp-p	200	240
Function	Voltage Adjustable Range(*10)		-40%, +10%	-40%, +18%
	Over Current Protection (*5)		105% - 140%	
	Over Voltage Protection(*6)(*9)		115% - 135%	125% - 140%
	Remote Sensing (*9)		Possible	
	Remote ON/OFF Control (*9)		Possible (SHORT : ON OPEN : OFF)	
	Parallel Operation (*9)		-	
	Series Operation (*9)		Possible	
Environment	Operating Temperature (*7)	°C	-40 to +100(Baseplate) Ambient temperature min=-40	
	Storage Temperature	°C	-40 to +100	
	Operating Humidity	%RH	5 - 95 (No dewdrop)	
	Storage Humidity	%RH	5 - 95 (No dewdrop)	
	Vibration		At no operating, 10-55Hz (sweep for 1min.) Amplitude 0.825mm constant (maximum 49.0m/s ²) X, Y, Z 1 hour each	
	Shock		196.1m/s ²	
	Cooling	(*8)	Conduction cooled	
	Isolation	Withstand Voltage		Input-Baseplate : 1.5kVDC, Input-Output : 1.5kVDC for 1min. Output-Baseplate : 500VDC for 1min.
Isolation Resistance			More than 100MΩ at 25°C and 70%RH Output-Baseplate...500VDC	
Standards	Safety Standards		Approved by UL60950-1, CSA C22.2 No.60950-1, EN60950-1.	
Mechanical	Weight (typ)	g	90	
	Size (W x H x D)	mm	61 x 12.7 x 57.9 (Refer to outline drawing)	

(*1) At 24VDC, 80% of maximum output current and baseplate temperature = +25°C.

(*2) At 24VDC and maximum output current.

(*3) 18 - 36VDC, constant load.

(*4) No load - full load, constant input voltage.

(*5) Constant current limiting with automatic recovery.

(*6) Inverter shutdown method, manual reset.

(*7) Ratings - Refer to derating curve on the right.
- Load(%) is percent of maximum output current.

(*8) Heatsink has to be chosen according to instruction manual.

(*9) Refer to instruction manual.

(*10) External components are needed for operation.
(Refer to basic connection and instruction manual.)

Outline Drawing

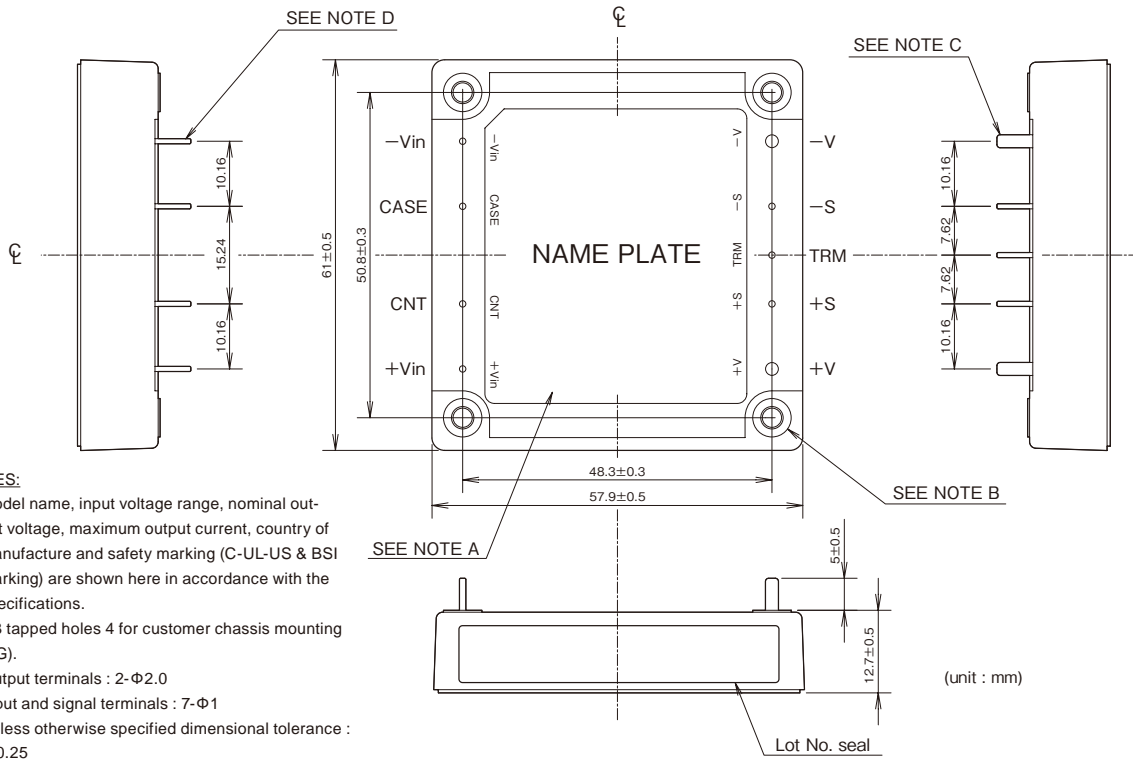

PAH

Derating Curve

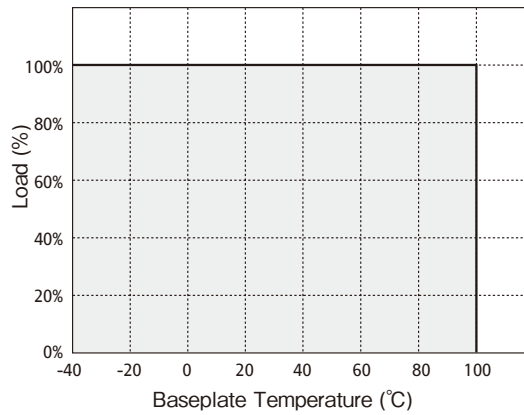

PAH350S24 Specifications

ITEMS/UNITS		MODEL	PAH350S24-28
Input	Voltage Range	V	DC18 - 36
	Efficiency (typ) (*1)	%	88
	Current (typ) (*2)	A	17.36
Output	Nominal Voltage	VDC	28
	Maximum Current	A	12.5
	Maximum Power	W	350
	Voltage Setting Accuracy (*2)	%	±1
	Maximum Line Regulation(*3)	mV	56
	Maximum Load Regulation(*4)	mV	56
	Temperature Coefficient		0.02%/°C
	Maximum Ripple & Noise(*10)	mVp-p	280
	Voltage Adjustable Range(*10)		-40%, +18%
Function	Over Current Protection (*5)		105% - 140%
	Over Voltage Protection(*6)(*9)		125% - 140%
	Remote Sensing (*9)		Possible
	Remote ON/OFF Control (*9)		Possible (SHORT : ON OPEN : OFF)
	Parallel Operation (*9)		-
	Series Operation (*9)		Possible
Environment	Operating Temperature (*7)	°C	-40 to +100(Baseplate) Ambient temperature min=-40
	Storage Temperature	°C	-40 to +100
	Operating Humidity	%RH	5 - 95 (No dewdrop)
	Storage Humidity	%RH	5 - 95 (No dewdrop)
	Vibration		At no operating, 10-55Hz (sweep for 1min.) Amplitude 0.825mm constant (maximum 49.0m/s ²) X, Y, Z 1 hour each
	Shock		196.1m/s ²
	Cooling	(*8)	Conduction cooled
	Isolation	Withstand Voltage	
Isolation Resistance			More than 100MΩ at 25°C and 70%RH Output-Baseplate...500VDC
Standards	Safety Standards		Approved by UL60950-1, CSA - C22.2 No.60950-1, EN60950-1.
Mechanical	Weight (typ)	g	100
	Size (W x H x D)	mm	61 x 12.7 x 57.9 (Refer to outline drawing)

(*1) At 24VDC, 80% of maximum output current and baseplate temperature = +25°C.

(*2) At 24VDC and maximum output current.

(*3) 18 - 36VDC, constant load.

(*4) No load - full load, constant input voltage.

(*5) Constant current limiting with automatic recovery.

(*6) Inverter shutdown method, manual reset.

(*7) Ratings - Refer to derating curve on the right.
- Load(%) is percent of maximum output current.

(*8) Heatsink has to be chosen according to instruction manual.

(*9) Refer to instruction manual.

(*10) External components are needed for operation.
(Refer to basic connection and instruction manual.)

Outline Drawing

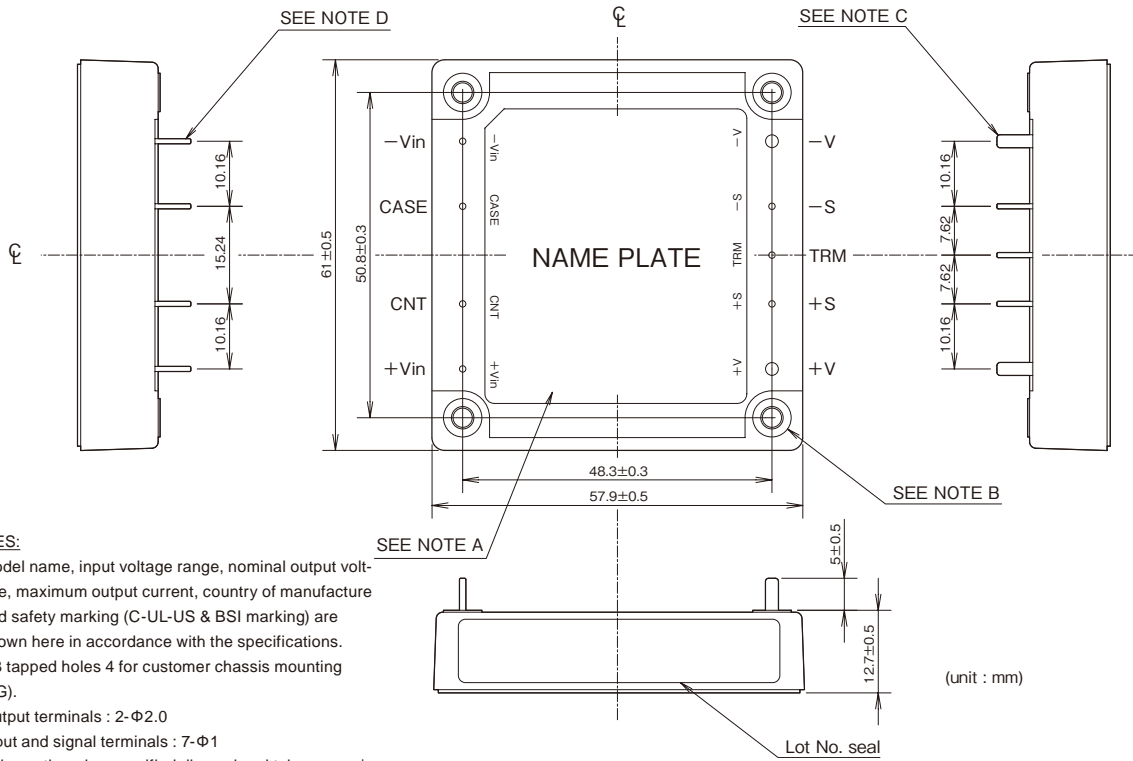

PAH

Derating Curve

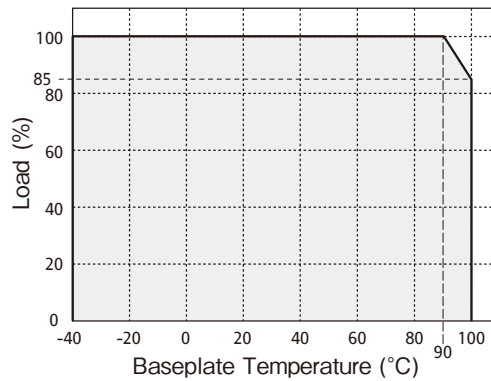

PAH50S48 Specifications

ITEMS/UNITS		MODEL	PAH50S48-2.5	PAH50S48-3.3	PAH50S48-5	PAH50S48-12	PAH50S48-15	PAH50S48-24	PAH50S48-28
Input	Voltage Range	V	36 - 76 VDC						
	Efficiency (typ) (*1)	%	76	79	83	85		86	87
	Current (typ) (*1)	A	0.8	1.02	1.26	1.24	1.25	1.22	1.21
Output	Nominal Voltage	VDC	2.5	3.3	5	12	15	24	28
	Minimum Current	A	0						
	Maximum Current	A	11.7		10	4.2	3.4	2.1	1.8
	Maximum Power	W	29.25	38.61	50.0	50.4	51.0	50.4	
	Voltage Setting Accuracy (*1)	%	±1.6						
	Maximum Line Regulation (*4)(*12)	mV	10			24	30	48	56
	Maximum Load Regulation(*5)(*12)	mV	10			24	30	48	56
	Temperature Coefficient		0.02%/°C						
	Maximum Ripple & Noise (-20~+100°C)(*3)	mVp-p	150			200		240	280
	Maximum Ripple & Noise (-40~-20°C)(*3)	mVp-p	300			250		300	350
	Voltage Adjustable Range (*2)		±10%		+15%, -40%	+10%, -40%			
	Function	Over Current Protection (*6)		105 - 150%					
Over Voltage Protection (*7)			120 - 160%	120 - 140%	125 - 145%				
Over Voltage Protection (*7)			Inverter shutdown (Option available: Refer to option table)						
Over Temperature Protection			Shutdown ; Auto-restart when unit cool down						
Remote Sensing (*10)			Possible (Connect +S and -S terminals to load)						
Remote ON/OFF Control (*8)			Negative logic (Option available: Refer to option table)						
Parallel Operation			-----						
Series Operation			Possible						
Environment	Operating Temperature	°C	-40 to +100 (Baseplate) Ambient temperature MIN =-40						
	Storage Temperature	°C	-40 to +100 (Baseplate) Ambient temperature MIN =-40						
	Operating Humidity	%RH	30 - 95 (No dewdrop)						
	Storage Humidity	%RH	30 - 95 (No dewdrop)						
	Vibration		At no operating, 10 - 55Hz amplitude (sweep 1 MIN) 0.825mm constant (maximum 49.0m/s²) X,Y,Z 1 hr each						
	Shock		196.1						
	Cooling (*9)		Conduction cooled						
Isolation	Withstand Voltage		Input - Output : 1.5kVAC, Input - Baseplate : 1.5kVAC (20mA) for 1 min Output - Baseplate : .500VDC for 1 min						
	Isolation Resistance		More than 100MOHM at 25°C and 70 %RH, Output - Baseplate : 500 VDC						
Standards	Safety Standards		Approved by UL60950-1, CSA C22.2 No.60950-1, EN60950-1.						
Mechanical	Weight	g	80						
	Size (W x H x D)	mm	57.9 x 12.7 x 61 (Refer to outline drawing)						

(*1) At 48 VDC, maximum output power and baseplate temperature = +25°C.

(*2) Additional external components have to be connected; refer to application notes.

(*3) External components are needed; Refer to basical connection drawing.

(*4) 36 - 76 VDC, constant load.

(*5) No load - full load, constant input voltage.

(*6) Current limiting with automatic recovery.

(*7) CNT reset or manual reset.

(*8) Refer to application notes.

(*9) Heatsink has to be chosen according to application notes.

(*10) If remote sensing is not required, connect +S and -S to +V and -V respectively (Refer to basical connection).

(*12) For -40°C to -20°C operation, the regulation for output 2.5V, 3.3V, 5V, 12V AND 15V is 40 mV.

Option table:

Option	ON/OFF Logic	OVP
Standard	Negative (H: OFF, L: ON)	Shut-down (ON/OFF control reset or manual reset)
/P	Positive (H: ON, L: OFF)	
/V	Negative (H: OFF, L: ON)	Auto restart
/PV	Positive (H: ON, L: OFF)	

Example: PAH50S48-5/P represent positive logic & OVP shut-down

Outline Drawing

[PAH50S]

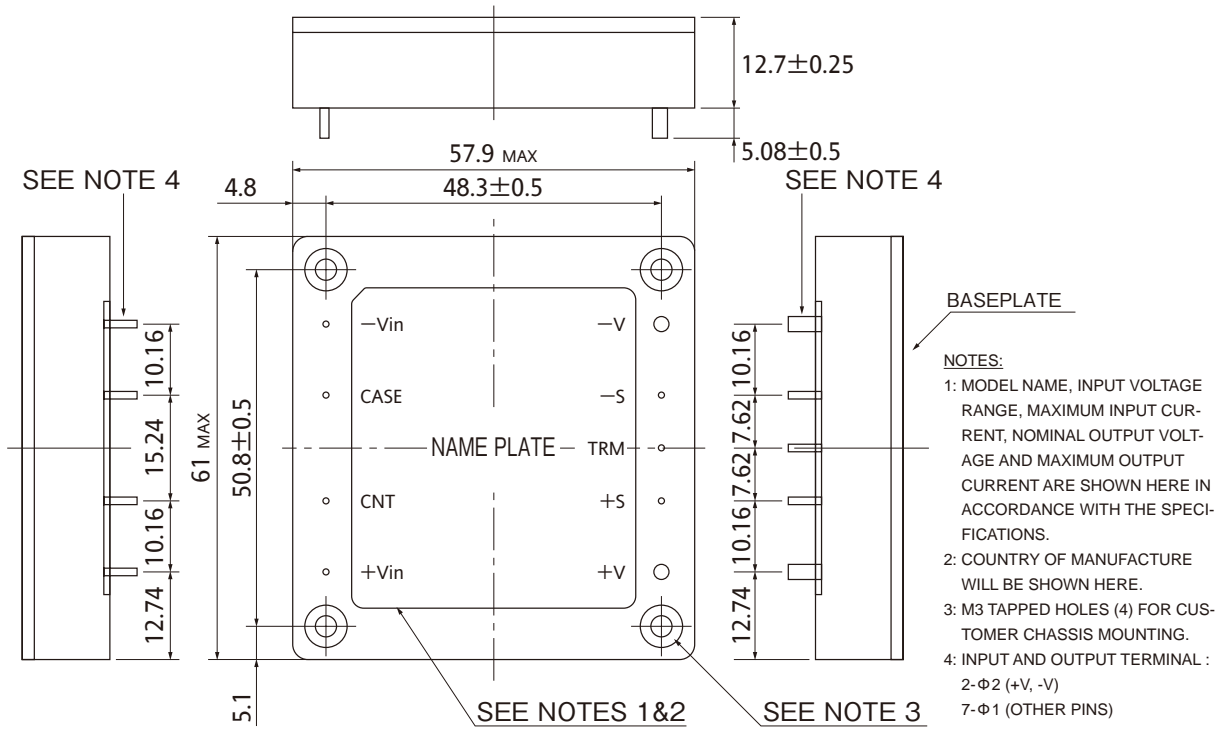

PAH

(unit : mm)

Derating Curve

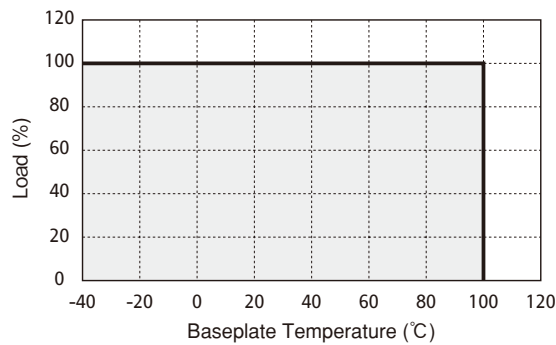

PAH75S48 Specifications

ITEMS/UNITS		MODEL	PAH75S48-2.5	PAH75S48-3.3	PAH75S48-5	PAH75S48-12	PAH75S48-15	PAH75S48-24	PAH75S48-28
Input	Voltage Range	V	DC36 - 76						
	Efficiency (typ) (*1)	%	76	79	83	85		87	
	Current (typ) (*1)	A	1.20	1.52	1.88	1.85	1.84	1.81	
Output	Nominal Voltage	VDC	2.5	3.3	5	12	15	24	28
	Minimum Current	A	0						
	Maximum Current	A	17.5		15	6.3	5	3.2	2.7
	Maximum Power	W	43.75	57.75	75.0	75.6	75.0	76.8	75.6
	Voltage Setting Accuracy (*1)	%	±1.6						
	Maximum Line Regulation (*4)(*12)	mV	10			24	30	48	56
	Maximum Load Regulation (*5)(*12)	mV	10			24	30	48	56
	Temperature Coefficient		0.02%/°C						
	Maximum Ripple & Noise (-20 to +100°C) (*3)	mVp-p	150			200		240	280
	Maximum Ripple & Noise (-40 to -20°C) (*3)	mVp-p	300			250		300	350
Function	Voltage Adjustable Range (*2)		±10%		+15%, -40%	+10%, -40%			
	Over Current Protection (*6)		105 - 150%						
	Over Voltage Protection (*7)		120 - 160%	120 - 140%	125 - 145%				
	Over Temperature Protection		Inverter shutdown (Option available: Refer to option table)						
	Remote Sensing (*10)		Shutdown ; Auto-restart when unit cool down						
	Remote ON/OFF Control (*8)		Possible (Connect +S and -S terminals to load)						
	Parallel Operation		Negative logic (Option available: Refer to option table)						
	Series Operation		-						
	Operating Temperature	°C	-40 to +100 (Baseplate)			Ambient temperature min = -40			
	Storage Temperature	°C	-40 to +100 (Baseplate)			Ambient temperature min = -40			
Environment	Operating Humidity	%RH	30 - 95 (No dewdrop)						
	Storage Humidity	%RH	30 - 95 (No dewdrop)						
	Vibration		At no operating, 10 ~ 55Hz amplitude (sweep 1 min) 0.825mm constant (maximum 49.0m/s ²) X, Y, Z 1 hr each						
	Shock		196.1m/s ²						
	Cooling (*9)		Conduction cooled						
	Withstand Voltage		Input - Output : 1.5kVAC, Input - Baseplate : 1.5kVAC (20mA) for 1 min Output - Baseplate : .500VDC for 1 min						
	Isolation Resistance		More than 100MOHM at 25°C and 70 %RH, Output - Baseplate : 500 VDC						
Standards	Safety Standards		Approved by UL60950-1, CSA-C 22.2 No.60950-1, EN60950-1.						
Mechanical	Weight	g	80						
	Size (W x H x D)	mm	57.9 x 12.7 x 61 (Refer to outline drawing)						

(*1) At 48 VDC, maximum output power and baseplate temperature = +25°C.

(*2) Additional external components have to be connected; Refer to application notes.

(*3) External components are needed; Refer to basical connection drawing.

(*4) 36 - 76 VDC, constant load.

(*5) No load - full load, constant input voltage.

(*6) Current limiting with automatic recovery.

(*7) CNT reset or manual reset.

(*8) Refer to application notes.

(*9) Heatsink has to be chosen according to application notes.

(*10) If remote sensing is not required, connect +S and -S to +V and -V respectively (Refer to basical connection).

(*12) For -40°C to -20°C operation, the regulation for output 2.5V, 3.3V, 5V, 12V and 15V is 40 mV.

Option table:

Option	ON/OFF Logic	OVP
Standard	Negative (H: OFF, L: ON)	Shut-down (ON/OFF control reset or manual reset)
/P	Positive (H: ON, L: OFF)	
/V	Negative (H: OFF, L: ON)	Auto restart
/PV	Positive (H: ON, L: OFF)	

Example: PAH75S48-5/P represent positive logic & OVP shut-down

Outline Drawing

[PAH75S48]

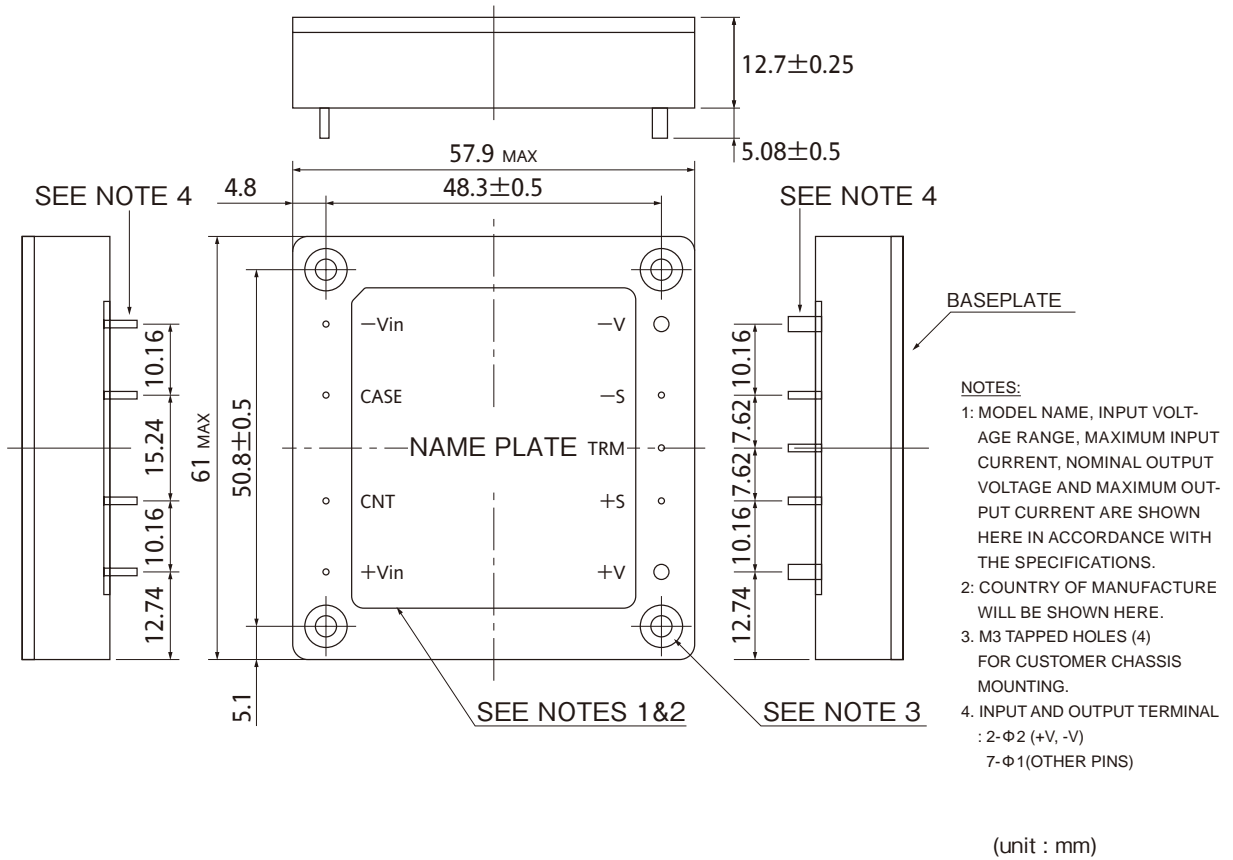

PAH

Derating Curve

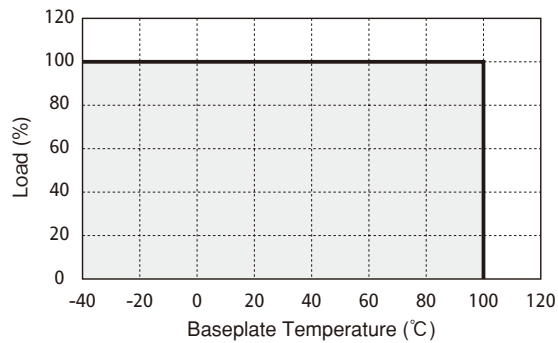

PAH100S48 Specifications

ITEMS/UNITS		MODEL	PAH100S48-2.5	PAH100S48-3.3	PAH100S48-5	PAH100S48-12	PAH100S48-15	PAH100S48-24	PAH100S48-28
Input	Voltage Range	V	DC36 - 76						
	Efficiency (typ) (*1)	%	75	80	84	86		88	
	Current (typ) (*1)	A	1.63	2.01	2.48	2.44		2.39	
Output	Nominal Voltage	VDC	2.5	3.3	5	12	15	24	28
	Minimum Current	A	0						
	Maximum Current	A	23.4		20.0	8.4	6.7	4.2	3.6
	Maximum Power	W	58.5	77.22	100.0	100.8	100.5	100.8	
	Voltage Setting Accuracy (*1)	%	±1.6						
	Maximum Line Regulation(*4)	mV	10			24	30	48	56
	Maximum Load Regulation(*5)	mV	10			24	30	48	56
	Temperature Coefficient		0.02%/°C						
	Maximum Ripple & Noise (-20~+100°C)(*3)	mVp-p	150			200		240	280
	Maximum Ripple & Noise (-40~-20°C)(*3)	mVp-p	200			250		300	350
Function	Voltage Adjustable Range (*2)		±10%		+15%, -40%	+10%, -40%			
	Over Current Protection (*6)		105 - 150%						
	Over Voltage Protection (*7)		120 - 160%	120 - 140%	125 - 145%				
	Over Temperature Protection		Inverter shutdown (Option available: Refer to option table)						
	Remote Sensing (*10)		Shutdown ; Auto-restart when unit cool down						
	Remote ON/OFF Control (*8)		Possible (Connect +S and -S terminals to load)						
	Parallel Operation		Negative logic (Option available: Refer to option table)						
	Series Operation		-						
	Operating Temperature	°C	-40 to +100 (Baseplate)			Ambient temperature min = -40°C			
	Storage Temperature	°C	-40 to +100 (Baseplate)			Ambient temperature min = -40°C			
Environment	Operating Humidity	%RH	30 - 95 (No dewdrop)						
	Storage Humidity	%RH	30 - 95 (No dewdrop)						
	Vibration		At no operating, 10 ~ 55Hz amplitude (sweep 1 min) 0.825mm constant (maximum 49.0m/s ²) X, Y, Z 1 hr each						
	Shock		196.1m/s ²						
	Cooling (*9)		Conduction cooled						
	Withstand Voltage		Input - Output : 1.5kVAC, Input - Baseplate : 1.5kVAC (20mA) for 1 min Output - Baseplate : .500VDC for 1 min						
	Isolation Resistance		More than 100MOHM at 25°C and 70 %RH, Output - Baseplate : 500 VDC						
Standards	Safety Standards		Approved by UL60950-1, CSA C22.2 No.60950-1, EN60950-1.						
Mechanical	Weight	g	80						
	Size (W x H x D)	mm	57.9 x 12.7 x 61 (Refer to outline drawing)						

(*1) At 48 VDC, maximum output power and baseplate temperature = +25°C.

(*2) Additional external components have to be connected; Refer to application notes.

(*3) External components are needed; Refer to basical connection drawing.

(*4) 36 - 76 VDC, constant load.

(*5) No load - full load, constant input voltage.

(*6) Current limiting with automatic recovery.

(*7) CNT reset or manual reset.

(*8) Refer to application notes.

(*9) Heatsink has to be chosen according to application notes.

(*10) If remote sensing is not required, connect +S and -S to +V and -V respectively (Refer to basical connection.)

Option table:

Option	ON/OFF Logic	OVP
Standard	Negative (H: OFF, L: ON)	Shut-down (ON/OFF control reset or manual reset)
/P	Positive (H: ON, L: OFF)	
/V	Negative (H: OFF, L: ON)	Auto restart
/PV	Positive (H: ON, L: OFF)	

Example: PAH100S48-5/P represent positive logic & OVP shut-down

Outline Drawing

[PAH100S48]

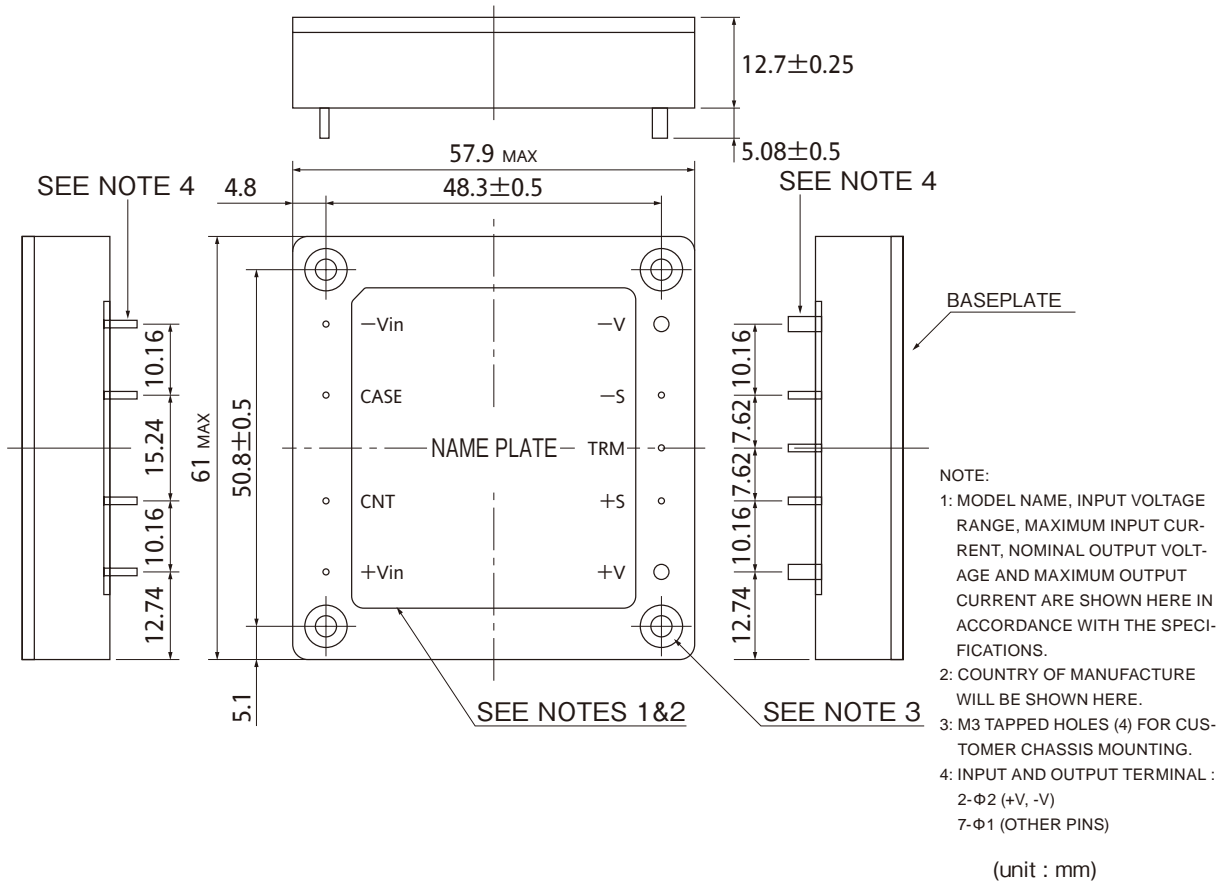

PAH

Derating Curve

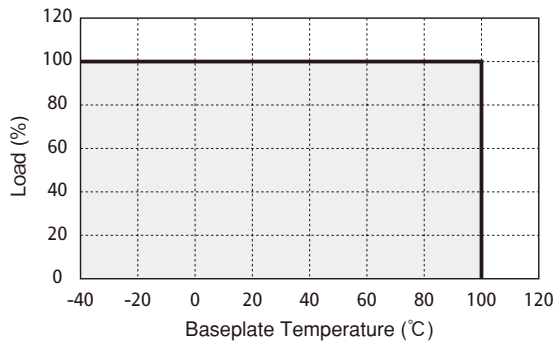

All specifications are subject to change without notice.

PAH150S48 Specifications

ITEMS/UNITS		MODEL	PAH150S48-2.5	PAH150S48-3.3	PAH150S48-5	PAH150S48-12	PAH150S48-15	PAH150S48-24	PAH150S48-28	PAH150S48-48
Input	Voltage Range	V	DC36 - 76							
	Efficiency (typ) (*1)	%	75	80	84	86		88		
	Current (typ) (*1)	A	2.43	3.01	3.72	3.63		3.58		3.64
Output	Nominal Voltage	VDC	2.5	3.3	5	12	15	24	28	48
	Minimum Current	A	0							
	Maximum Current	A	35		30	12.5	10	6.3	5.4	3.2
	Maximum Power	W	87.5	115.5	150		151.2		153.6	
	Voltage Setting Accuracy (*1)	%	±1.6							
	Maximum Line Regulation(*4)	mV	10			24	30	48	56	96
	Maximum Load Regulation(*5)	mV	10			24	30	48	56	96
	Temperature Coefficient		0.02%/°C							
	Maximum Ripple & Noise (-20 to +100°C) (*3)	mVp-p	150			200		240	280	250
	Maximum Ripple & Noise (-40 to -20°C) (*3)	mVp-p	200			250		300	350	400
Function	Voltage Adjustable Range (*2)		±10%		+15%, -40%	+10%, -40%			±20%	
	Over Current Protection (*6)		105 - 150%							
	Over Voltage Protection (*7)		120 - 160%	120 - 140%	125 - 145%				135 - 155%	
	Over Temperature Protection		Inverter shutdown (Option available: Refer to option table)							
	Remote Sensing (*10)		Shutdown ; Auto-restart when unit cool down							
	Remote ON/OFF Control (*8)		Possible (Connect +S and -S terminals to load)							
	Parallel Operation		Negative logic (Option available: Refer to option table)							
	Series Operation		-							
	Operating Temperature	°C	Possible							
	Storage Temperature	°C	-40 to +100 (Baseplate) Ambient temperature min = -40°C							
Environment	Operating Humidity	%RH	-40 to +100 (Baseplate) Ambient temperature min = -40°C							
	Storage Humidity	%RH	30 - 95 (No dewdrop)							
	Vibration		30 - 95 (No dewdrop)							
	Shock		At no operating, 10 ~ 55Hz amplitude (sweep 1 min) 0.825mm constant (maximum 49.0m/s ²) X, Y, Z 1 hr each							
	Cooling	(*9)	196.1 m/s ²							
	Withstand Voltage		Conduction cooled							
	Isolation Resistance		Input - Output : 1.5kVAC, Input - Baseplate : 1.5kVAC (20mA) for 1 min Output - Baseplate : .500VDC for 1 min							
Standards	Safety Standards		More than 100MOHM at 25°C and 70 %RH, Output - Baseplate : 500 VDC							
	Weight	g	Approved by UL60950-1, CSA C22.2 No.60950-1, EN60950-1.							
Mechanical	Weight	g	80							
	Size (W x H x D)	mm	57.9 x 12.7 x 61 (Refer to outline drawing)							

(*1) At 48 VDC, maximum output power and baseplate temperature = +25°C.

(*2) Additional external components have to be connected; Refer to application notes.

(*3) External components are needed; Refer to basical connection drawing.

(*4) 36 - 76 VDC, constant load.

(*5) No load - full load, constant input voltage.

(*6) Current limiting with automatic recovery.

(*7) CNT reset or manual reset.

(*8) Refer to application notes.

(*9) Heatsink has to be chosen according to application notes.

(*10) If remote sensing is not required, connect +S and -S to +V and -V respectively (Refer to basical connection.)

Option table:

Option	ON/OFF Logic	OVP
Standard	Negative (H: OFF, L: ON)	Shut-down (ON/OFF control reset or Manual reset)
/P	Positive (H: ON, L: OFF)	
/V	Negative (H: OFF, L: ON)	Auto restart
/PV	Positive (H: ON, L: OFF)	

Example: PAH150S48-5/P represent positive logic & OVP shut-down

Outline Drawing

[PAH150S48]

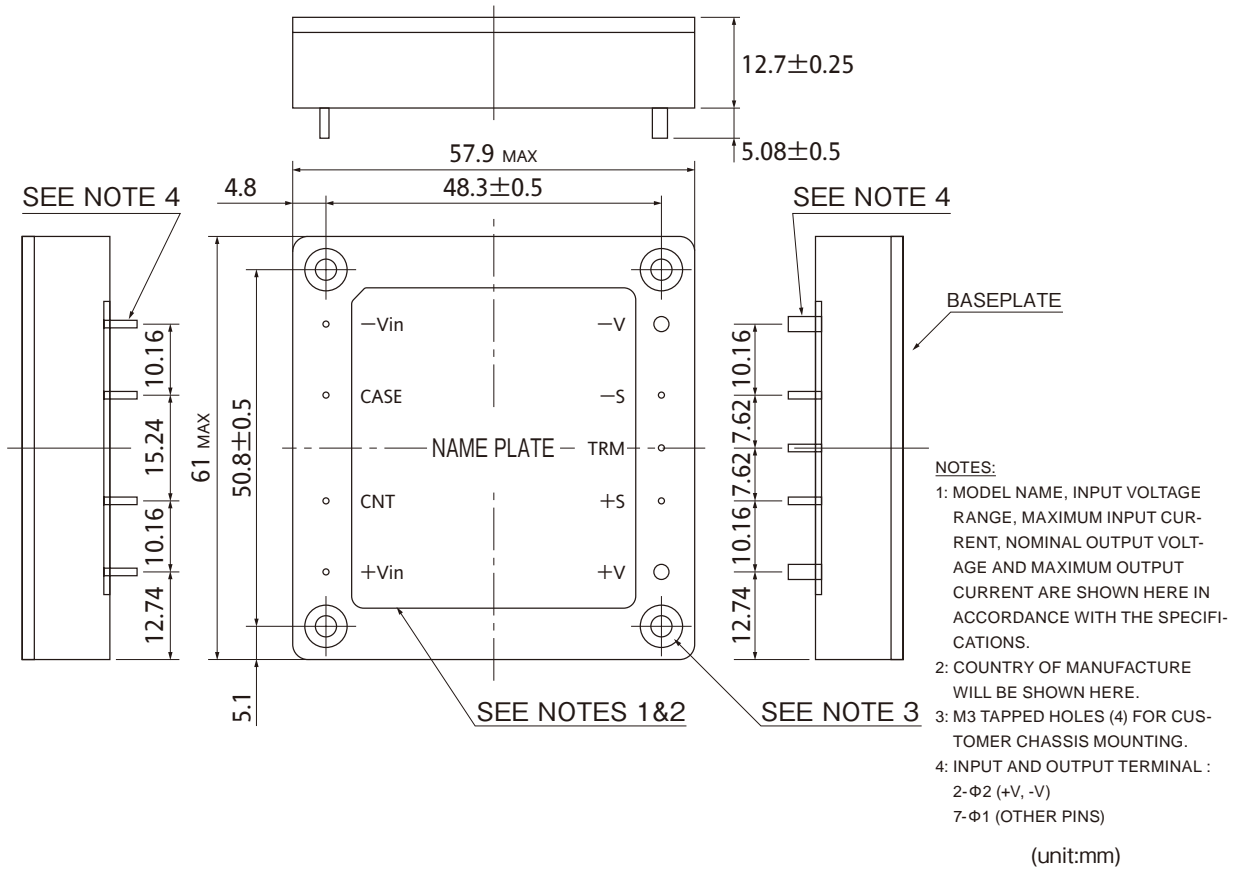

PAH

Derating Curve

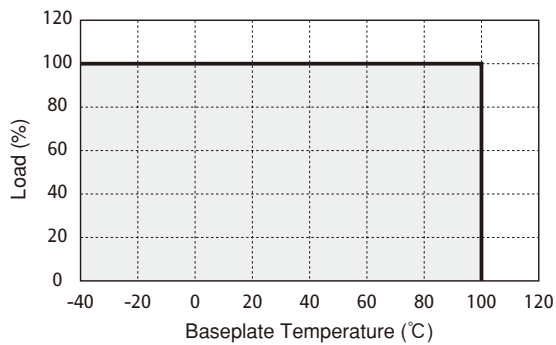

PAH200S48 Specifications

ITEMS/UNITS		MODEL	PAH200S48-12	PAH200S48-15	PAH200S48-24	PAH200S48-28
Input	Voltage Range	V	DC36 - 76			
	Efficiency (typ) (*1)	%	85		87	
	Current (typ) (*1)	A	4.91	4.92	4.82	
Output	Nominal Voltage	VDC	12	15	24	28
	Minimum Current	A	0			
	Maximum Current	A	16.7	13.4	8.4	7.2
	Maximum Power	W	200.4	201.0	201.6	
	Voltage Setting Accuracy (*1)	%	±1.6			
	Maximum Line Regulation(*4)	mV	24	30	48	56
	Maximum Load Regulation (*5)	mV	24	30	48	56
	Temperature Coefficient		0.02%/°C			
	Maximum Ripple & Noise (-20 to +100°C) (*3)	mVp-p	200		240	280
	Maximum Ripple & Noise (-40 to -20°C) (*3)	mVp-p	250		300	350
	Voltage Adjustable Range (*2)		+10%, -40%			
Function	Over Current Protection (*6)		105 -150%			
	Over Voltage Protection (*7)		125 - 145%			
	Over Temperature Protection		Inverter shutdown (Option available: Refer to option table)			
	Remote Sensing (*10)		Shutdown ; Auto-restart when unit cool down			
	Remote ON/OFF Control (*8)		Possible (Connect +S and -S terminals to load)			
	Parallel Operation		Negative logic (Option available: Refer to option table)			
	Series Operation		-			
			Possible			
Environment	Operating Temperature (*11)	°C	Baseplate -40 to +80 : 100% of max. load ; min. Ta = -40 +100 : 90% of max. load			
	Storage Temperature	°C	-40 to +100 (Baseplate) Ambient temperature min = -40			
	Operating Humidity	%RH	30 - 95 (No dewdrop)			
	Storage Humidity	%RH	30 - 95 (No dewdrop)			
	Vibration		At no operating, 10 - 55Hz amplitude (sweep 1 min) 0.825mm Constant (maximum 49.0m/s ²) X, Y, Z 1 hr each			
	Shock		196.1m/s ²			
	Cooling (*9)		Conduction cooled			
Isolation	Withstand Voltage		Input - Output : 1.5kVAC, Input - Baseplate : 1.5kVAC (20mA) for 1 min Output - Baseplate : .500VDC for 1 min			
	Isolation Resistance		More than 100MOHM at 25°C and 70 %RH, Output - Baseplate : 500 VDC			
Standards	Safety Standards		Approved by UL60950-1, CSA C22.2 No.60950-1, EN60950-1.			
Mechanical	Weight	g	80			
	Size (W x H x D)	mm	57.9 x 12.7 x 61 (Refer to outline drawing)			

(*1) At 48 VDC, maximum output power and baseplate temperature = +25°C.

(*2) Additional external components have to be connected; Refer to application notes.

(*3) External components are needed; Refer to basical connection drawing.

(*4) 36 ~ 76 VDC, constant load.

(*5) No load ~ full load, constant input voltage.

(*6) Current limiting with automatic recovery.

(*7) CNT reset or manual reset.

(*8) Refer to application notes.

(*9) Heatsink has to be chosen according to application notes.

(*10) If remote sensing is not required, connect +S and -S to +V and -V respectively (Refer to basical connection.)

(*11) Refer to output derating curve.

Option table:

Option	ON/OFF Logic	OVP
Standard	Negative (H: OFF, L: ON)	Shut-down (ON/OFF control reset or manual reset)
/P	Positive (H: ON, L: OFF)	
/V	Negative (H: OFF, L: ON)	Auto restart
/PV	Positive (H: ON, L: OFF)	

Example: PAH200S48-5/P represent positive logic & OVP shut-down

Outline Drawing

[PAH200S48]

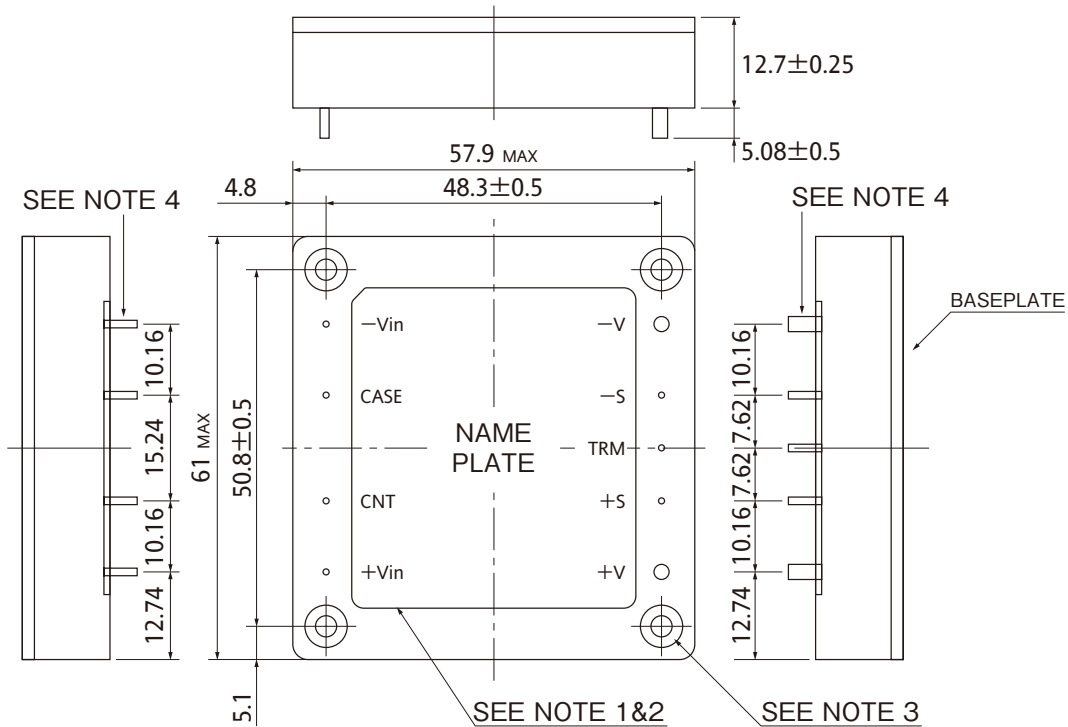

NOTES:

- 1: MODEL NAME, INPUT VOLTAGE RANGE, MAXIMUM INPUT CURRENT, NOMINAL OUTPUT VOLTAGE AND MAXIMUM OUTPUT CURRENT ARE SHOWN HERE IN ACCORDANCE WITH THE SPECIFICATIONS.
- 2: COUNTRY OF MANUFACTURE WILL BE SHOWN HERE.
- 3: M3 TAPPED HOLES (4) FOR CUSTOMER CHASSIS MOUNTING.
- 4: INPUT AND OUTPUT TERMINAL : 2-Φ2 (+V, -V), 7-Φ1 (OTHER PINS)

(unit : mm)



Derating Curve

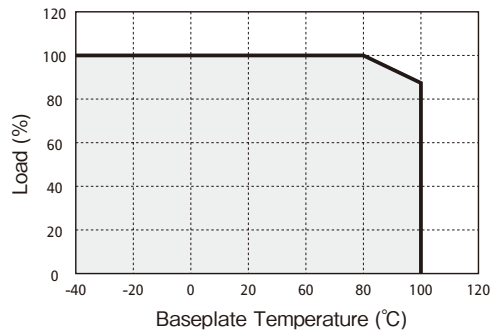

PAH300S48 Specifications

ITEMS/UNITS		MODEL	PAH300S48-12	PAH300S48-28
Input	Voltage Range	V	36 - 76VDC	
	Efficiency (typ) (*1)	%	90	
	Current (typ) (*2)	A	7.02	7.21
Output	Nominal Voltage	V	12	28
	Maximum Current	A	25	11
	Maximum Power	W	300	308
	Voltage Setting Accuracy (*2)	%	±1	
	Maximum Line Regulation (*3)	mV	24	56
	Maximum Load Regulation (*4)	mV	24	56
	Temperature Coefficient		0.02%/°C	
Function	Maximum Ripple & Noise (*10)	mVp-p	200	240
	Voltage Adjustable Range (*10)		-40%, +10%	-40%, +18%
	Over Current Protection (*5)		105% - 140%	
	Over Voltage Protection (*6) (*9)		115% - 135%	125% - 140%
	Remote Sensing (*9)		Possible	
	Remote ON/OFF Control (*9)		Possible (SHORT : ON OPEN : OFF)	
	Parallel Operation (*9)		-	
Environment	Series Operation (*9)		Possible	
	Operating Temperature (*7)	°C	-40 to +100 (Baseplate) Ambient temperature min=-40	
	Storage Temperature	°C	-40 to +100	
	Operating Humidity	%RH	5 - 95 (No dewdrop)	
	Storage Humidity	%RH	5 - 95 (No dewdrop)	
	Vibration		At no operating, 10-55Hz (sweep for 1min.) Amplitude 0.825mm constant (maximum 49.0m/s ²) X, Y, Z 1 hour each	
	Shock		196.1m/s ²	
Isolation	Cooling (*8)		Conduction cooled	
	Withstand Voltage		Input-Baseplate : 1.5kVDC, Input-Output : 1.5kVDC for 1min. Output-Baseplate : 500VDC for 1min.	
	Isolation Resistance		More than 100MΩ at 25°C and 70%RH Output-Baseplate...500VDC	
Standards	Safety Standards		Approved by UL60950-1, CSA C22.2 No.60950-1, EN60950-1.	
Mechanical	Weight (typ)	g	90	
	Size (W x H x D)	mm	61 x 12.7 x 57.9 (Refer to outline drawing)	

(*1) At 48VDC, 80% of maximum output current and baseplate temperature = +25°C.

(*2) At 48VDC and maximum output current.

(*3) 36 - 76VDC, constant load.

(*4) No load - full load, constant input voltage.

(*5) Constant current limiting with automatic recovery.

(*6) Inverter shutdown method, manual reset.

(*7) Ratings - Refer to derating curve on the right.
- Load(%) is percent of maximum output current.

(*8) Heatsink has to be chosen according to instruction manual.

(*9) Refer to instruction manual.

(*10) External components are needed for operation.
(Refer to basic connection and instruction manual.)

Outline Drawing

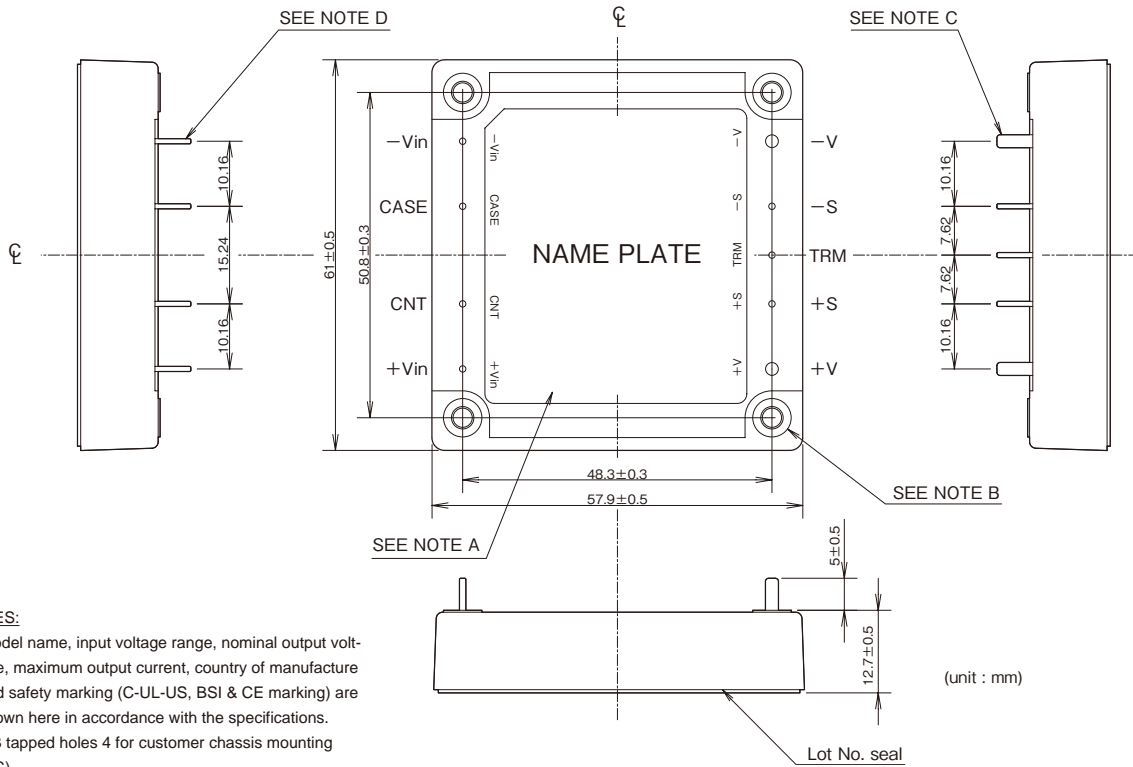

NOTES:

- A: Model name, input voltage range, nominal output voltage, maximum output current, country of manufacture and safety marking (C-UL-US, BSI & CE marking) are shown here in accordance with the specifications.
- B: M3 tapped holes 4 for customer chassis mounting (FG).
- C: Output terminals : 2-Φ2.0
- D: Input and signal terminals : 7-Φ1
- E: Unless otherwise specified dimensional tolerance : ±0.25

PAH

Derating Curve

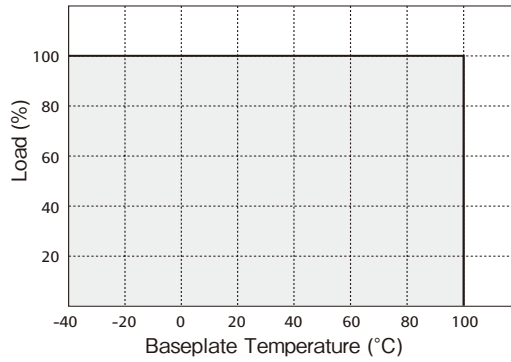

PAH350S48 Specifications

ITEMS/UNITS		MODEL	PAH350S48-12	PAH350S48-28
Input	Voltage Range	V	36 - 76VDC	
	Efficiency (typ) (*1)	%	89	
	Current (typ) (*2)	A	8.25	8.24
Output	Nominal Voltage	V	12	28
	Maximum Current	A	29.2	12.5
	Maximum Power	W	350.4	350
	Voltage Setting Accuracy (*2)	%	±1	
	Maximum Line Regulation (*3)	mV	24	56
	Maximum Load Regulation (*4)	mV	24	56
	Temperature Coefficient		0.02%/°C	
	Maximum Ripple & Noise (*10)	mVp-p	200	280
	Voltage Adjustable Range (*10)		-40%, +10%	-40%, +18%
	Function	Over Current Protection (*5)		105% - 140%
Over Voltage Protection (*6)(*9)			115% - 135%	125% - 140%
Remote Sensing (*9)			Possible	
Remote ON/OFF Control (*9)			Possible (SHORT : ON OPEN : OFF)	
Parallel Operation (*9)			-	
Series Operation (*9)			Possible	
Environment	Operating Temperature (*7)	°C	-40 to +100 (Baseplate) Ambient temperature min=-40	
	Storage Temperature	°C	-40 to +100	
	Operating Humidity	%RH	5 - 95 (No dewdrop)	
	Storage Humidity	%RH	5 - 95 (No dewdrop)	
	Vibration		At no operating, 10-55Hz (sweep for 1min.) Amplitude 0.825mm constant (maximum 49.0m/s ²) X, Y, Z 1 hour each	
	Shock		196.1m/s ²	
	Cooling (*8)		Conduction cooled	
	Isolation	Withstand Voltage		Input-Baseplate : 1.5kVDC, Input-Output : 1.5kVDC for 1min. Output-Baseplate : 500VDC for 1min.
Isolation Resistance			More than 100MΩ at 25°C and 70%RH Output-Baseplate...500VDC	
Standards	Safety Standards		Approved by UL60950-1, CSA C22.2 No.60950-1, EN60950-1.	
Mechanical	Weight (typ)	g	100	
	Size (WxHxD)	mm	61 x 12.7 x 57.9 (Refer to outline drawing)	

(*1) At 48VDC, 80% of maximum output current and baseplate temperature = +25°C.

(*2) At 48VDC and maximum output current.

(*3) 36 - 76VDC, constant load.

(*4) No load - full load, constant input voltage.

(*5) Constant current limiting with automatic recovery.

(*6) Inverter shutdown method, manual reset.

(*7) Ratings - Refer to derating curve on the right.
- Load(%) is percent of maximum output current.

(*8) Heatsink has to be chosen according to instruction manual.

(*9) Refer to instruction manual.

(*10) External components are needed for operation.
(Refer to basic connection and instruction manual.)

Outline Drawing

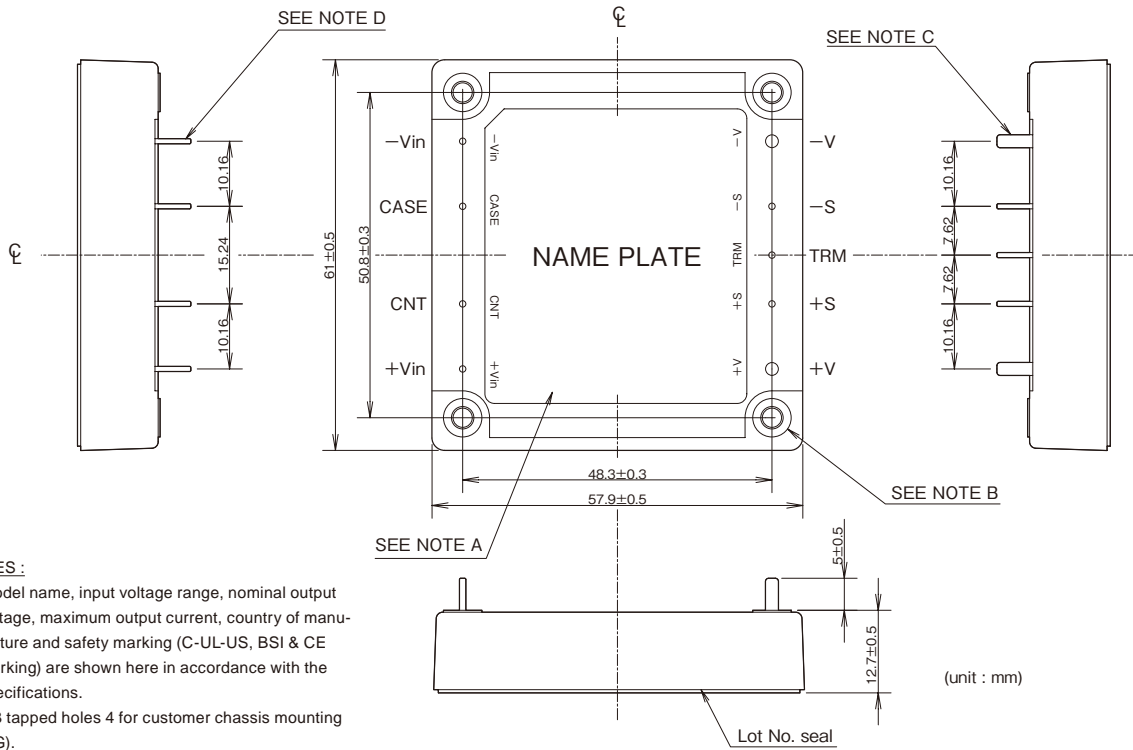

NOTES :

- A: Model name, input voltage range, nominal output voltage, maximum output current, country of manufacture and safety marking (C-UL-US, BSI & CE marking) are shown here in accordance with the specifications.
- B: M3 tapped holes 4 for customer chassis mounting (FG).
- C: Output terminals : 2-Φ2.0
- D: Input and signal terminals : 7-Φ1
- E: Unless otherwise specified dimensional tolerance : ±0.25

PAH

(unit : mm)

Derating Curve

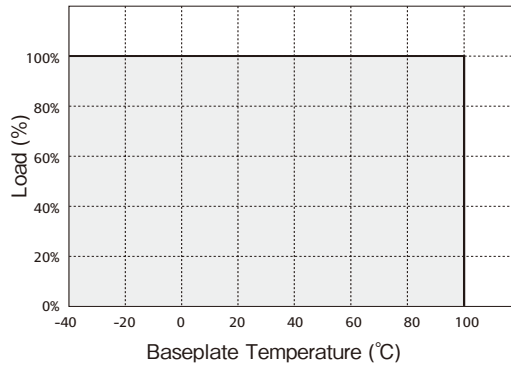

PAH450S48 Specifications

ITEMS/UNITS		MODEL	PAH450S48-28	PAH450S48-48
Input	Voltage Range	V	36 - 76 VDC	
	Efficiency (typ) (*1)	%	92	
	Current (typ) (*2)	A	10.3	10.4
Output	Nominal Voltage	VDC	28	48
	Maximum Current	A	16	9.4
	Maximum Power	W	448	451.2
	Voltage Setting Accuracy (*2)	%	±1	
	Maximum Line Regulation(*3)	mV	56	96
	Maximum Load Regulation(*4)	mV	56	96
	Temperature Coefficient		0.02%/°C	
	Maximum Ripple & Noise(*10)	mVp-p	280	480
Function	Voltage Adjustable Range(*10)		-40%, +18%	-40%, +20%
	Over Current Protection (*5)		105% - 140%	
	Over Voltage Protection (*6)(*9)		125% - 145%	
	Remote Sensing (*9)		Possible	
	Remote ON/OFF Control (*9)		Possible (SHORT : ON OPEN : OFF)	
	Parallel Operation (*9)		-	
Environment	Series Operation (*9)		Possible	
	Operating Temperature (*7)	°C	-40 to +100 (Baseplate) Ambient temperature min=-40	
	Storage Temperature	°C	-40 to +100	
	Operating Humidity	%RH	5 - 95 (No dewdrop)	
	Storage Humidity	%RH	5 - 95 (No dewdrop)	
	Vibration		At no operating, 10-55Hz (sweep for 1min.) Amplitude 0.825mm constant (maximum 49.0m/s ²) X,Y,Z 1 hour each	
	Shock		196.1m/s ²	
	Cooling (*8)		Conduction cooled	
Isolation	Withstand Voltage		Input-Baseplate : 1.5kVDC, Input-Output : 1.5kVDC for 1min. Output-Baseplate : 500VDC for 1min.	
	Isolation Resistance		More than 100MΩ at 25°C and 70%RH Output-Baseplate...500VDC	
Standards	Safety Standards		Approved by UL60950-1, CSA C22.2 No.60950-1, EN60950-1.	
Mechanical	Weight (typ)	g	100	
	Size (W x H x D)	mm	61 x 12.7 x 57.9 (Refer to outline drawing)	

(*1) At 48VDC, 80% of maximum output current and baseplate temperature = +25°C.

(*2) At 48VDC and maximum output current. baseplate temperature = +25°C.

(*3) 36 - 76VDC, constant load.

(*4) No load - full load, constant input voltage.

(*5) Constant current limiting with automatic recovery.

(*6) Inverter shutdown method, manual reset.

(*7) Ratings - Refer to derating curve on the right.

- Load(%) is percent of maximum output current.

- Refer to instruction manual.

(*8) Heatsink has to be chosen according to instruction manual.

(*9) Refer to instruction manual.

(*10) External components are needed for operation.
(Refer to basic connection and instruction manual.)

Outline Drawing

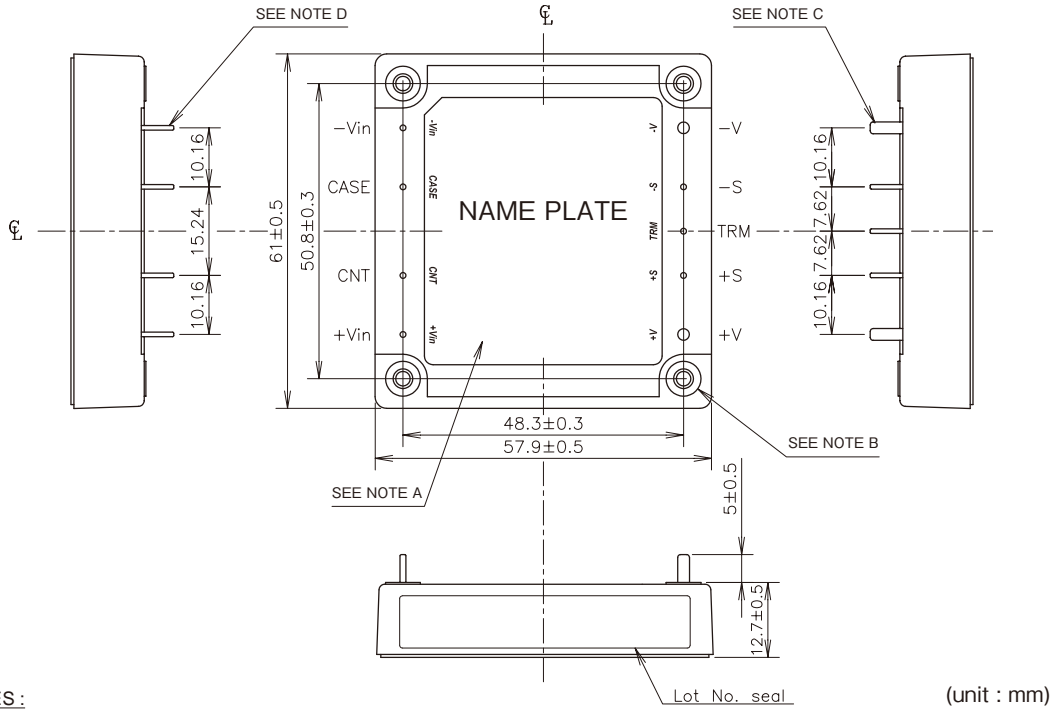

NOTES :

- A: Model name, input voltage range, nominal output voltage, maximum output current, country of manufacture and safety marking (C-UL-US, BSI & CE marking) are shown here in accordance with the specifications.
- B: M3 threaded holes 4 for customer chassis mounting (FG).
- C: Output terminals : 2- Φ 2.0
- D: Input and signal terminals : 7- Φ 1
- E: Unless otherwise specified dimensional tolerance : ± 0.25

(unit : mm)



Derating Curve

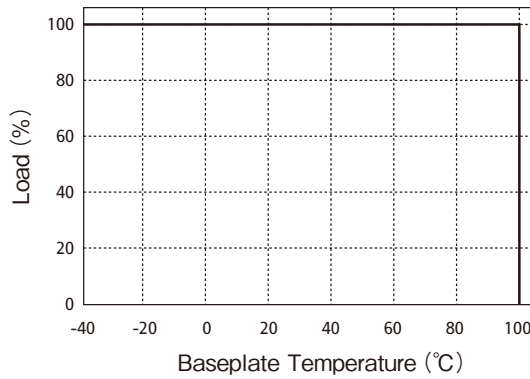

PAH75D24 Specifications

ITEMS/UNITS		MODEL	PAH75D24-3325		PAH75D24-5033	
		CH	1	2	1	2
Input	Voltage Range	V	DC18 - 36			
	Efficiency (typ) (*2)	%	76		80	
	Current (typ) (*2)	A	2.71		3.91	
Output	Nominal Voltage	VDC	3.3	2.5	5	3.3
	Minimum Current	A	0.0			
	Maximum Current	A	15			
	Maximum Power (*1)	W	Po1+Po2=60		Po1+Po2=75	
	Voltage Setting Accuracy (*2)	%	± 2			
	Maximum Line Regulation(*5)	mV	±6.6		±10	±6.6
	Maximum Load Regulation(*6)	mV	±16.5		±25	±16.5
	Temperature Coefficient		0.02			
	Maximum Ripple & Noise (*4)	mVp-p	100	75	100	
	Voltage Adjustable Range(*3)		±10%			
Function	Over Current Protection (*7)		105-165% Vo2@0A	105-165% Vo1@5A	105-165% Vo2@0A	105-165% Vo1@5A
	Over Voltage Protection (*8)(*9)		115-140%		125-145%	115-140%
	Over Temperature Protection		Shutdown ; Auto restart when unit cool down			
	Remote Sensing		-			
	Remote ON/OFF Control (*9)		Negative logic (Option available : Refer to option table)			
	Parallel Operation		-			
	Series Operation		-			
Environment	Operating Temperature	°C	-40 to +100 (Baseplate) Ambient temperature min = -40°C			
	Storage Temperature	°C	-40 to +100 (Baseplate) Ambient temperature min = -40°C			
	Operating Humidity	%RH	30 - 95 (No dewdrop)			
	Storage Humidity	%RH	30 - 95 (No dewdrop)			
	Vibration		At no operating, 10 - 55HZ amplitude (sweep 1 min) 0.825mm constant (maximum 49.0m/s ²) X, Y, Z 1 hr each			
	Shock		196.1			
	Cooling (*10)		Conduction cooled			
Isolation	Withstand Voltage		Input - Output : 1.5kVDC, Input - Baseplate : 1.5kVDC (20mA) for 1 min Output - Baseplate : .500VDC for 1 min			
	Isolation Resistance		More than 100MOHM at 25°C and 70 %RH, Output - Baseplate : 500 VDC			
Standards	Safety Standards		Approved by UL60950-1, CSA C22.2 No.60950-1, EN60950-1.			
Mechanical	Weight	g	80			
	Size (W x H x D)	mm	57.9 x 12.7 x 61 (Refer to outline drawing)			

(*1) Combination output power for both channel.

(*2) At 24 VDC, Vo1 @ 15A, Vo2 @ 0A and baseplate temperature = +25°C.

(*3) Additional external components have to be connected;
Refer to application notes.

(*4) Measured at Tbp=25°C, Vin=24VDC and with external components connected;
Refer to basic connection drawing. For all of temperature range, please refer to the application note.

(*5) 18 - 36 VDC with respect to nominal input line 24V;
constant load;
baseplate temperature = +25°C.

(*6) No load - full load with respect to 50% of max. load;
other output : no load ; constant input voltage;
baseplate temperature = +25°C.

(*7) Current limiting with automatic recovery.

(*8) CNT reset or manual reset.

(*9) Refer to application notes.

(*10) Heatsink has to be chosen according to application notes.

Option table:

Option	ON/OFF Logic	OVP
Standard	Negative (L: ON, H: OFF)	Shut-down
/P	Positive (H: OFF, L: ON)	
/V	Negative (L: ON, H: OFF)	Auto-restart
/PV	Positive (H: OFF, L: ON)	Shut-down

Example:

PAH75D24-3325/PV: Represent positive logic & OVP auto-restart.

Outline Drawing

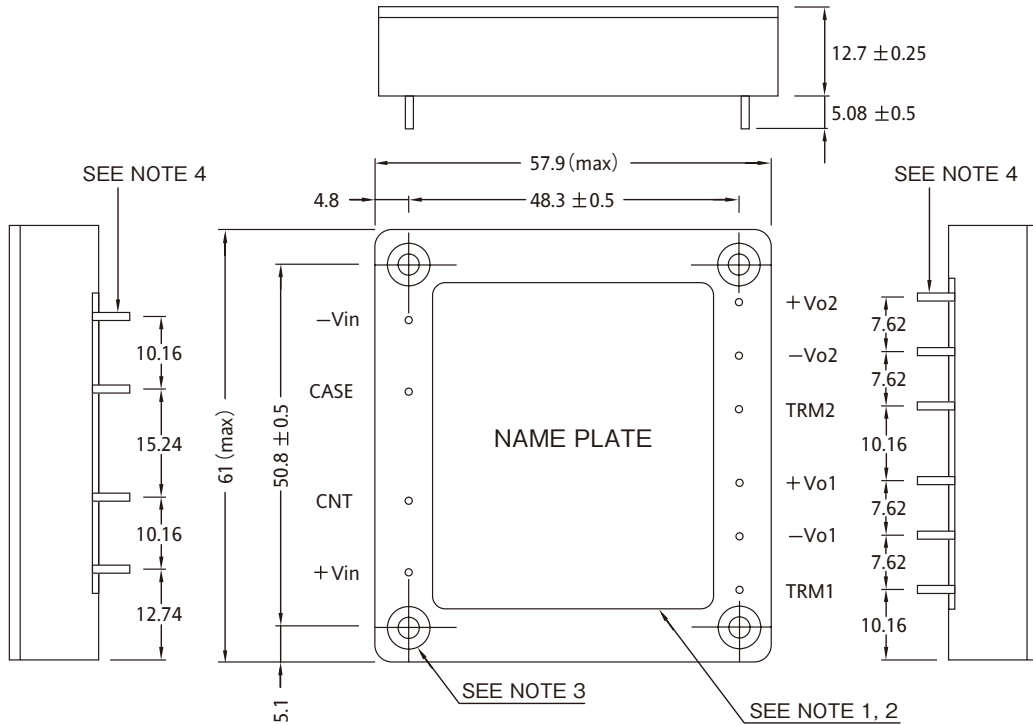

NOTE :

1. MODEL NAME, INPUT VOLTAGE RANGE, MAXIMUM INPUT CURRENT, NOMINAL OUTPUT VOLTAGE AND MAXIMUM OUTPUT CURRENT ARE SHOWN HERE IN ACCORDANCE WITH THE SPECIFICATIONS.
2. COUNTRY OF MANUFACTURE WILL BE SHOWN HERE.
3. M3 TAPPED HOLES (4) FOR CUSTOMER CHASSIS MOUNTING.
4. INPUT AND OUTPUT TERMINAL : 10-Φ1.0

Derating Curve

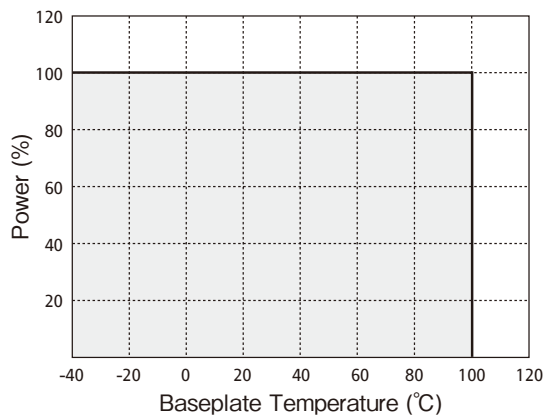

PAH75D48 Specifications

ITEMS/UNITS		MODEL	PAH75D48-2518		PAH75D48-3318		PAH75D48-3325		PAH75D48-5033	
		CH	1	2	1	2	1	2	1	2
Input	Voltage Range	V	DC36 - 76							
	Efficiency (typ) (*2)	%	74		78				82	
	Current (typ) (*2)	A	1.06		1.33				1.91	
Output	Nominal Voltage	VDC	2.5	1.8	3.3	1.8	3.3	2.5	5.0	3.3
	Minimum Current	A	0							
	Maximum Current	A	15							
	Maximum Power (*1)	W	Po1+Po2=45		Po1+Po2=50		Po1+Po2=60		Po1+Po2=75	
	Voltage Setting Accuracy (*2)	%	± 2							
	Maximum Line Regulation (*5)	mV	±6.6				±10		±6.6	
	Maximum Load Regulation (*6)	mV	±16.5				±25		±16.5	
	Temperature Coefficient		0.02%/°C							
	Maximum Ripple & Noise (*4)	mVp-p	75		100	75	100	75	100	
	Voltage Adjustable Range (*3)		+10%, -0%	+10%, -0%	±10%	+10%, -0%	±10%			
Function	Over Current Protection (*7)		105-165% Vo2@0A	105-165% Vo1@5A	105-165% Vo2@0A	105-165% Vo1@5A	105-165% Vo2@0A	105-165% Vo1@5A	105-165% Vo2@0A	105-165% Vo1@5A
	Over Voltage Protection (*8)(*9)		115-140%	115-150%	115-140%	115-150%	115-140%		125-145%	115-140%
			Inverter shutdown (Option available : Refer to option table)							
	Over Temperature Protection		Shutdown ; Auto restart when unit cool down							
	Remote Sensing		-							
	Remote ON/OFF Control (*9)		Negative logic (Option available : Refer to option table)							
	Parallel Operation		-							
Series Operation		-								
Environment	Operating Temperature	°C	-40 to +100 (Baseplate) Ambient temperature min = -40°C							
	Storage Temperature	°C	-40 to +100 (Baseplate) Ambient temperature min = -40°C							
	Operating Humidity	%RH	30 - 95 (No dewdrop)							
	Storage Humidity	%RH	30 - 95 (No dewdrop)							
	Vibration		At no operating, 10 - 55HZ amplitude (sweep 1 min) 0.825mm constant (maximum 49.0m/s ²) X, Y, Z 1 hr each							
	Shock		196.1m/s ²							
	Cooling (*10)		Conduction cooled							
Isolation	Withstand Voltage		Input - Output : 1.5kVDC, Input - Baseplate : 1.5kVDC (20mA) for 1 min Output - Baseplate : .500VDC for 1 min							
	Isolation Resistance		More than 100MOHM AT 25°C and 70 %RH, Output - Baseplate : 500 VDC							
Standards	Safety Standards		Approved by UL60950-1, CSA C22.2 No.60950-1, EN60950-1.							
Mechanical	Weight	g	80							
	Size (W x H x D)	mm	57.9 x 12.7 x 61 (Refer to outline drawing)							

(*1) Combination output power for both channel.

(*2) AT 48 VDC, Vo2 @ 0A, Vo1 @ 15 A and baseplate temperature = +25°C.

(*3) Additional external components have to be connected;
Refer to application notes.

(*4) Measured at Tbp=25°C, Vin=48VDC and with external components connected;
Refer to basic connection drawing. For all of temperature range,
Please refer to the application note.

(*5) 36 - 76 VDC with respect to nominal input line 48 V;
Constant load; baseplate temperature = +25°C.

(*6) No load - full load with respect to 50% of max. load;
other output : NO load ; constant input voltage;
baseplate temperature = +25°C.

(*7) Current limiting with automatic recovery.

(*8) CNT reset or manual reset.

(*9) Refer to application notes.

(*10) Heatsink has to be chosen according to application notes.

Option table:

Option	ON/OFF Logic	OVP
Standard	Negative (L: ON, H: OFF)	Shut-down
/P	Positive (H: ON, L: OFF)	Shut-down
/V	Negative (L: ON, H: OFF)	Auto restart
/PV	Positive (H: ON, L: OFF)	Auto restart

EXAMPLE:

PAH75D48-3325/PV: Represent positive logic & OVP auto-restart

Outline Drawing

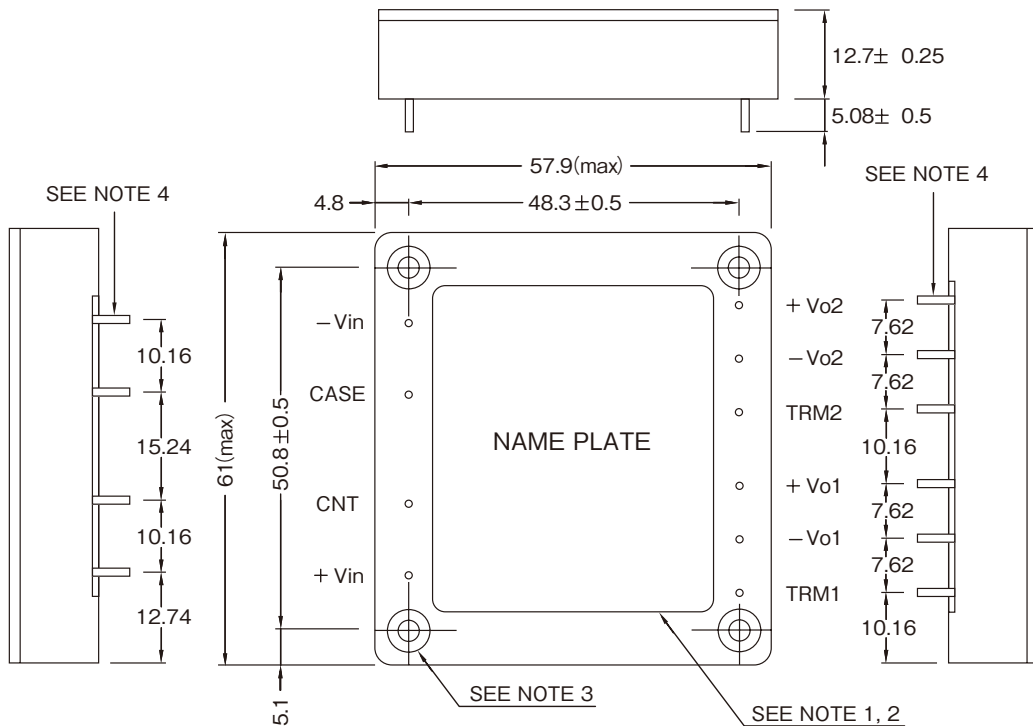

PAH

NOTE :

1. MODEL NAME, INPUT VOLTAGE RANGE, MAXIMUM INPUT CURRENT, NOMINAL OUTPUT VOLTAGE AND MAXIMUM OUTPUT CURRENT ARE SHOWN HERE IN ACCORDANCE WITH THE SPECIFICATIONS.
2. COUNTRY OF MANUFACTURE WILL BE SHOWN HERE.
3. M3 TAPPED HOLES (4) FOR CUSTOMER CHASSIS MOUNTING.
4. INPUT AND OUTPUT TERMINAL : 10-Φ1.0

Derating Curve

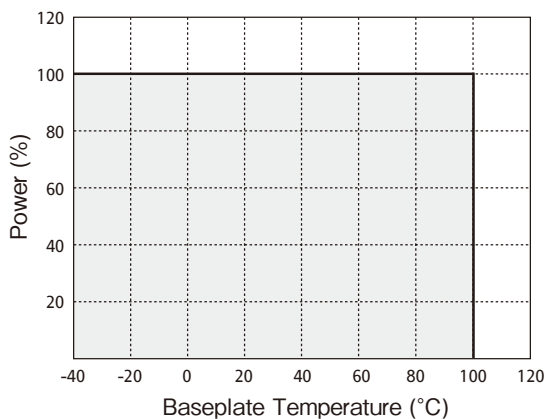

PAH200H Specifications

ITEMS/UNITS		MODEL	PAH200H48-1R2	PAH200H48-1R5	PAH200H48-1R8	PAH200H48-2R5	PAH200H48-3R3
Input	Voltage Range (*6)	V	DC36 - 76 (100VDC, 100ms)				
	Efficiency (typ) (*1)	%	82	84	87	88	90
	Current (typ) (*1)	A	2.19	2.67	3.08	4.23	4.68
Output	Nominal Voltage	VDC	1.2	1.5	1.8	2.5	3.3
	Maximum Current	A	70				60
	Maximum Power	W	84	105	126	175	198
	Voltage Setting Accuracy (*1)	%	±1				
	Maximum Line Regulation (*2)	mV	10				
	Maximum Load Regulation (*3)	mV	10				
	Temperature Coefficient		Less than 0.02%/°C				
	Maximum Ripple & Noise (*8)	mVp-p	100				
	Voltage Adjustable Range(*8)		-20%, +10%				
Function	Over Current Protection (*4)		105% - 140% (Option available : Refer to option table)				
	Over Voltage Protection (*5)		120% - 140% (Option available : Refer to option table)				
	Remote Sensing (*6)		Possible				
	Remote ON/OFF Control		Possible (Option available : Refer to option table)				
	Parallel Operation (*6)		-				
	Series Operation (*6)		Possible				
Environment	Operating Temperature (*7)	°C	Ta= -40 to +85				
	Storage Temperature	°C	-40 to +100				
	Operating Humidity	%RH	5 - 95 (No dewdrop)				
	Storage Humidity	%RH	5 - 95 (No dewdrop)				
	Vibration		At no operating, 10-55Hz (sweep for 1min.) Amplitude 0.825mm constant (maximum 49.0m/s ²) X, Y, Z 1 hour each				
	Shock		196.1m/s ²				
	Cooling (*7)		Convection cooled / Forced air cooled				
Isolation	Withstand Voltage		Input-Output : 1.5kVAC (20mA) for 1min				
	Isolation Resistance		More than 100MΩ at 25°C and 70%RH Input-Output...500VDC				
Standards	Safety Standards		Approved by UL60950-1, CSA C22.2 No.60950-1, EN60950-1.				
Mechanical	Weight (typ)	g	90				
	Size (W x H x D)	mm	61 x 10.2 x 57.9 (Refer to outline drawing)				

PAH

(*1) At 48VDC, maximum output current, air velocity = 2m/s and Ta = +25°C.

(*2) 36 - 76VDC, constant load.

(*3) No load - full load, constant input voltage.

(*4) Constant current limiting. (The unit automatically shutdown when left in OCP condition with the output voltage less than the LVP level.)
Auto restart option available.

(*5) Inverter shutdown method, manual reset. Auto restart option available.

(*6) Refer to instruction manual.

(*7) Refer to derating curve and instruction manual.

(*8) External components are needed for operation.
(Refer to basic connection. and instruction manual.)

Basic connections

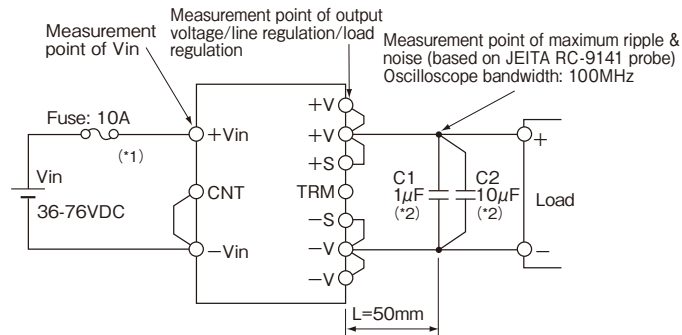

(*1) 1: The PAH200H series is not equipped with a fuse. Be sure to set a fast-blow fuse for the enhancement of safety and to get approval for safety standards. When using multiple units of the PAH200H series, set a fuse for each unit.

(*2) C1: 1µF ceramic capacitor
C2: 10µF electrolytic capacitor or tantalum capacitor

Option table:

Option	ON/OFF Logic	OVP, OCP
Standard	Negative (Short: ON, Open: OFF)	Shut-down (ON/OFF control reset or manual reset)
/V		Auto restart
/P	Positive (Short: OFF, Open: ON)	Shut down (ON/OFF control reset or manual reset)
/PV		Auto restart

Outline Drawing

[PAH200H]

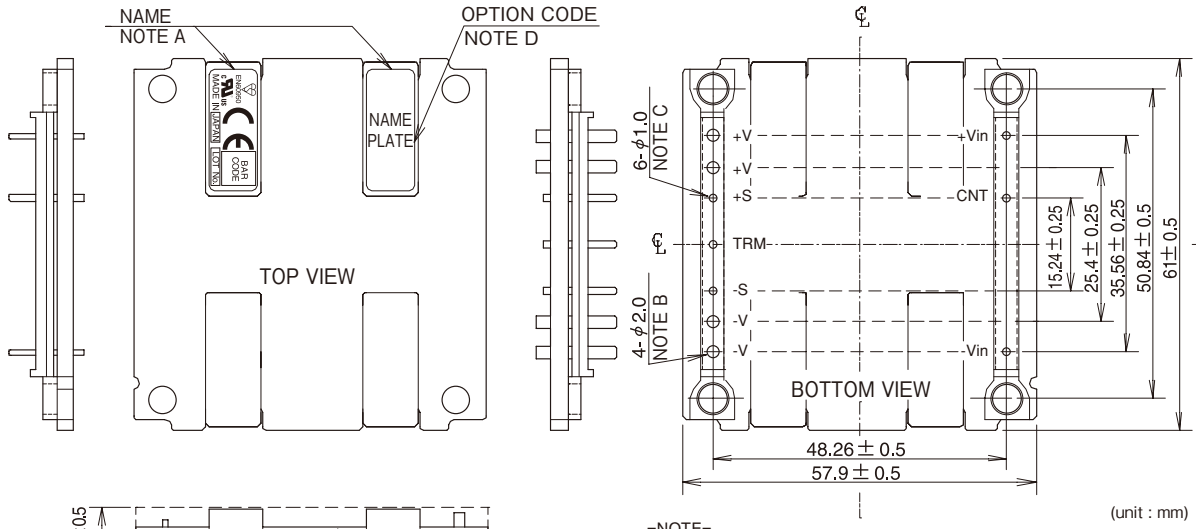

=NOTE=
 (unit : mm)
 A: Model name, country of manufacture, Lot No. and safety marking (BSI, C-UL-US & CE marking) are shown here in accordance with the specifications.
 B: Output pin of +V and -V : 4-Φ2.0
 C: Signal and Input pin : 6-Φ1.0
 D: Option

OPTION CODE	OVP/OCP	REMOTE ON/OFF CONTROL
NOTHING	SHUT DOWN (ON/OFF CONT. RESET OR MANUAL RESET)	NEGATIVE (SHORT : ON OPEN : OFF)
/V	AUTO RESTART	
/P	SHUT DOWN (ON/OFF CONT. RESET OR MANUAL RESET)	POSITIVE (SHORT : OFF OPEN : ON)
/PV	AUTO RESTART	



Output Derating

● Output derating by ambient temperature

Please refer to instruction manual.

● Output derating by PCB temperature

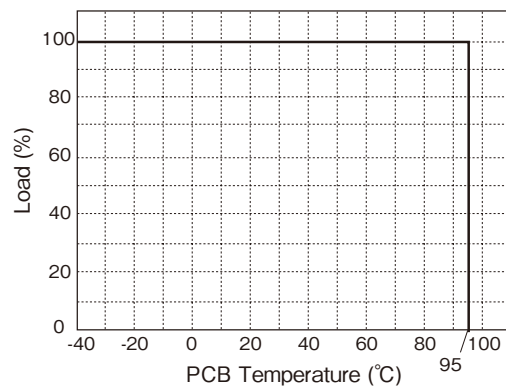

When using with different measurement conditions from output derating by ambient temperature, use output derating by PCB temperature.
 PCB temperature is decided by temperature of the component surface below.
 Measurement of PCB temperature is recommended to ensure the module to operate within the derating curve.

Measuring point of PCB temperature

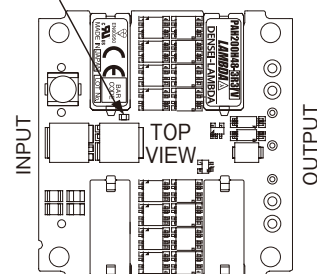

Block Diagram

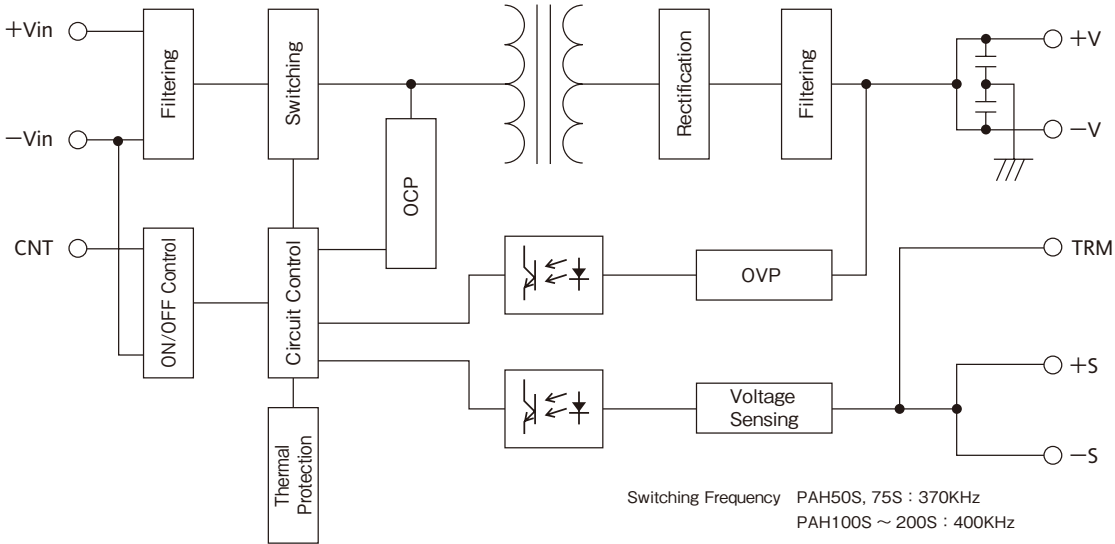

PAH

Sequence Time Chart

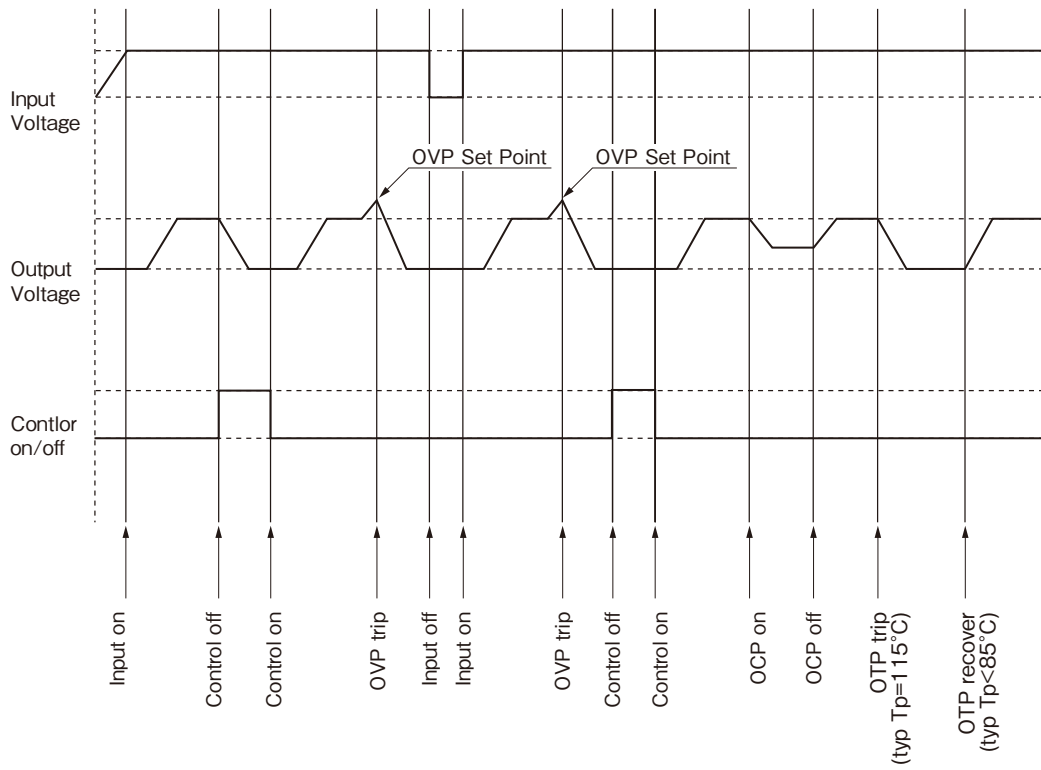

Note: This timing diagram is for negative logic "ON/OFF" option.

Block Diagram

[PAH300S24, PAH350S24]

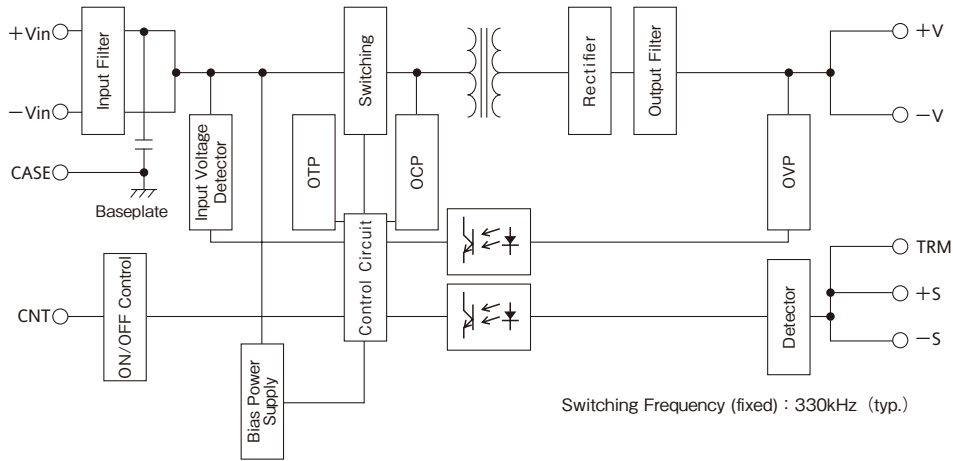

[PAH300S48, PAH350S48]

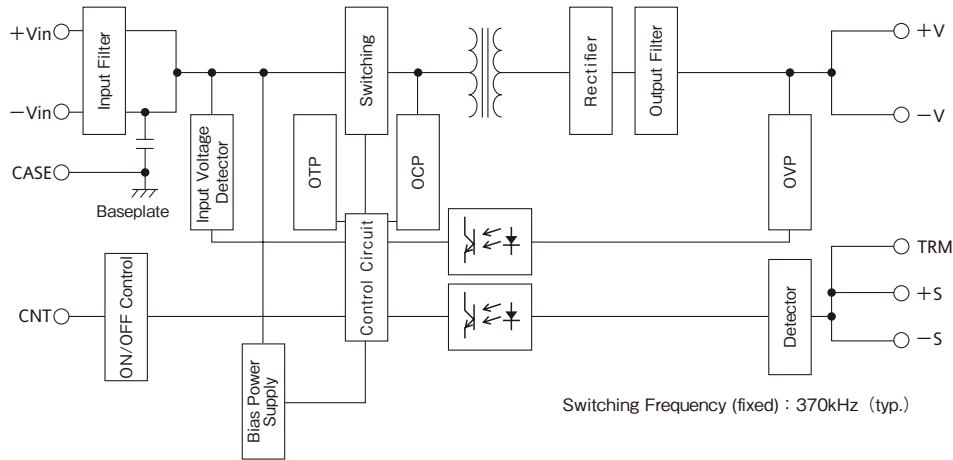

PAH

Sequence Time Chart

(For standard model with negative logic for ON/OFF control.)

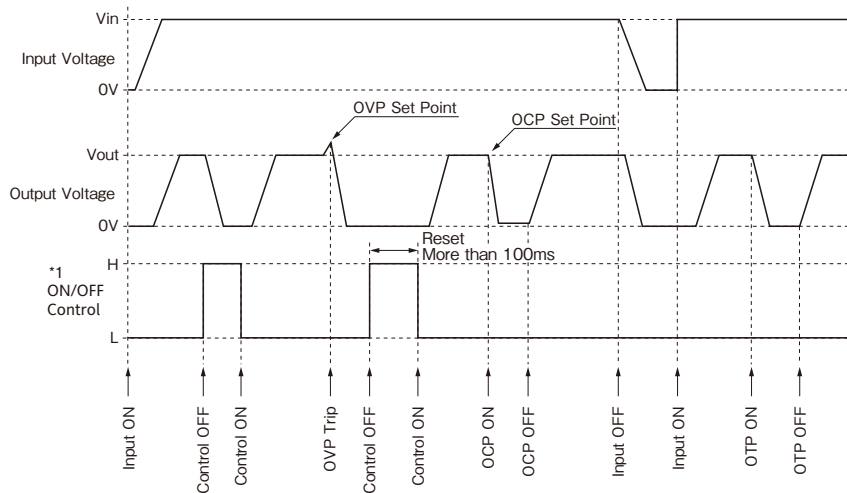

*1 level : $4 \leq H \leq 35(V)$ or Open
 $0 \leq L \leq 0.8(V)$ or Short

Block Diagram

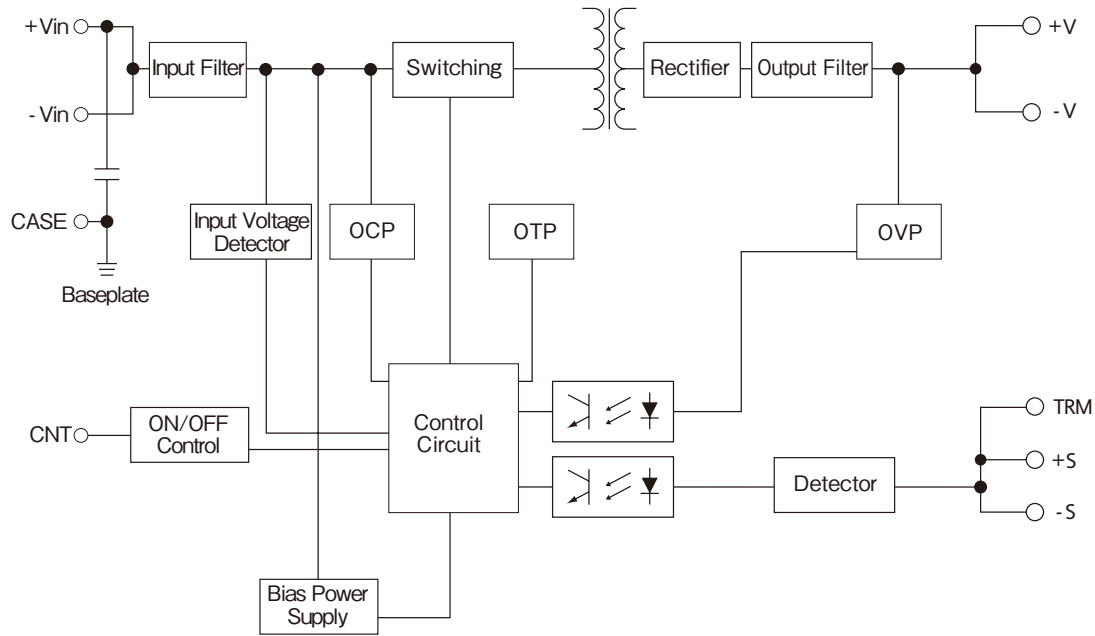

PAH

Switching Frequency (fixed) : 400kHz (typ.) for 28V Model, 460kHz (typ.) for 48V Model

Sequence Time Chart

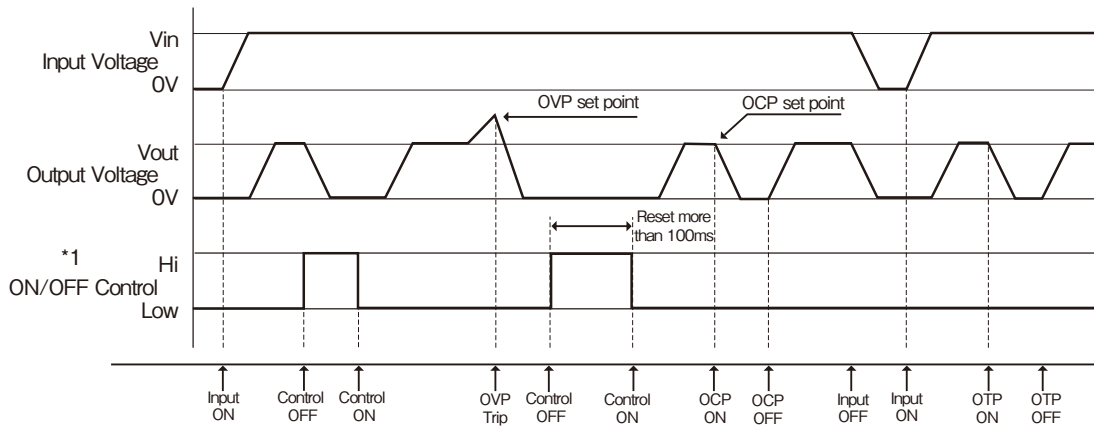

*1 level : $4 \leq H \leq 35$ (V) or Open
 $0 \leq L \leq 0.8$ (V) or Short

Block Diagram

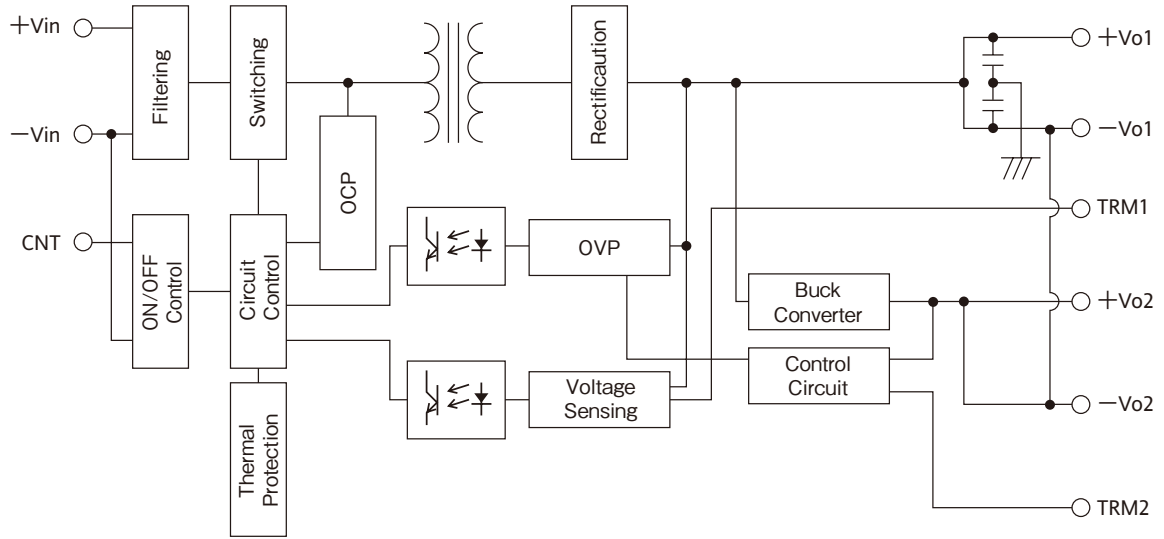

Switching Frequency: 325kHz

Sequence Time Chart

PAH

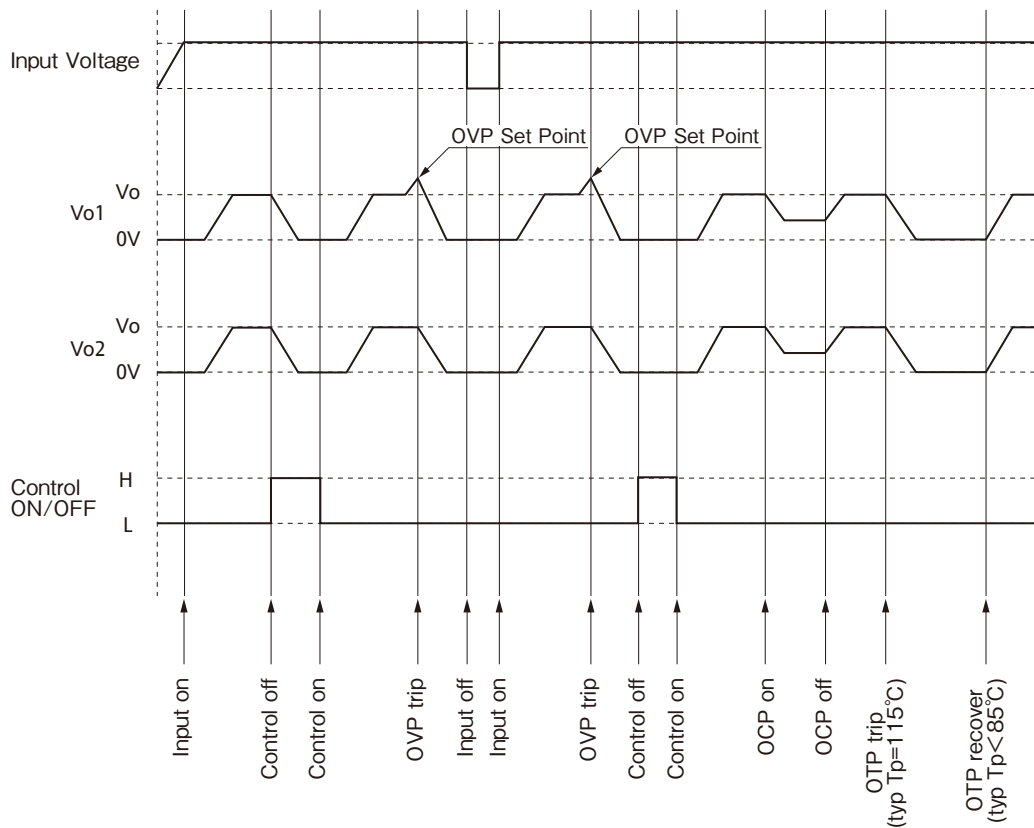

Note: This timing diagram is for Negative Logic "ON/OFF" Option.

Block Diagram

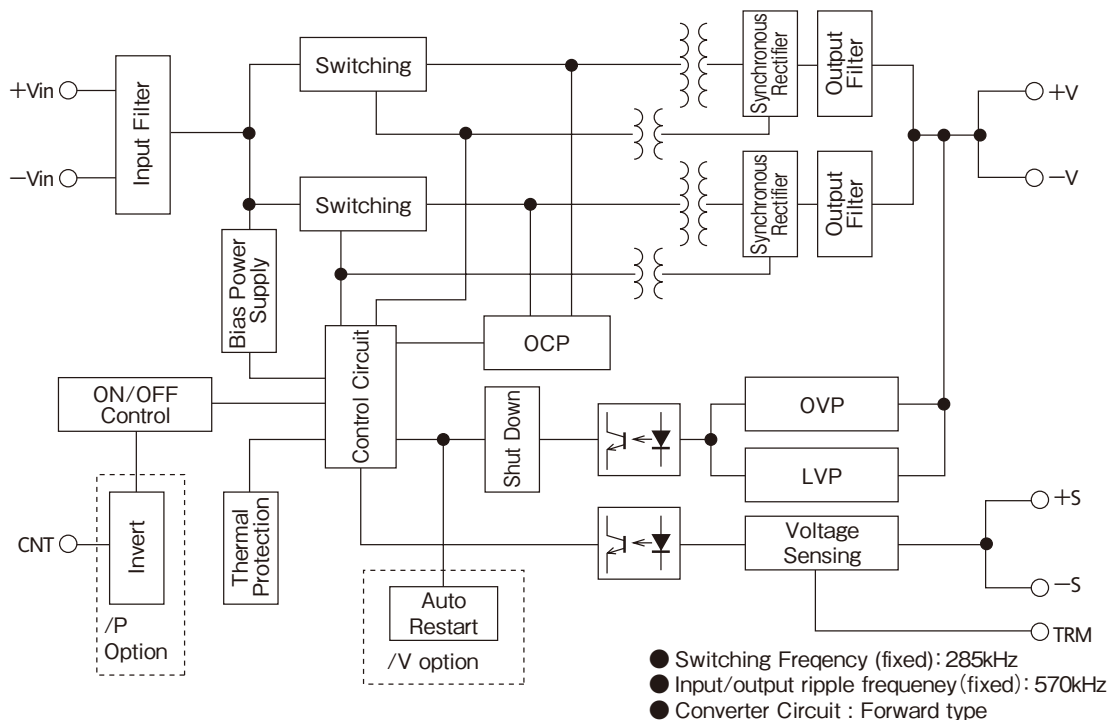

PAH



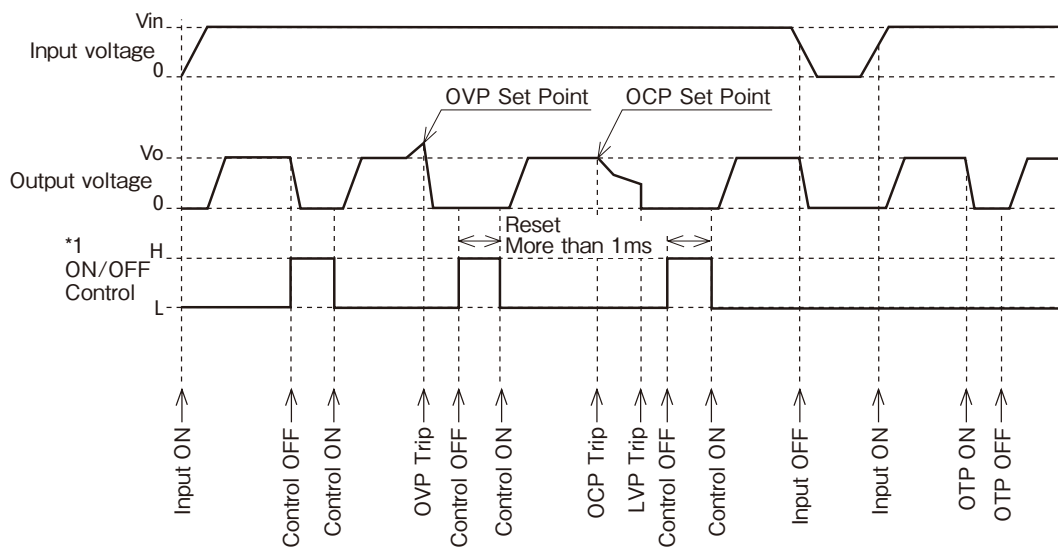

Sequence Time Chart

(For standard model with latch type OVP and OCP, negative logic for ON/OFF control)



*1 level: $4 \leq H \leq 35(V)$ or Open
 $0 \leq L \leq 0.8(V)$ or Short

PAH300, 350S24 SERIES Instruction Manual

- PAH50S48 ~ 200S48 Instruction Manual  B-182Page
- PAH300S48, 350S48 Instruction Manual  B-189Page
- PAH450S48 Instruction Manual  B-196Page
 - PAH75D Instruction Manual  B-204Page
 - PAH200H Instruction Manual  B-216Page

Before using this product

Be sure to take note of precautions and warnings indicated in this manual when using this product. Improper usage may lead to electric shock or fire. Be sure to read this instruction manual thoroughly before using this product.

Precautions

- Avoid touching the baseplate and the case of this product because they get hot.
- There are high voltage and high temperature components within this product. Refrain from disassembling this product or touching its internal components as this may lead to electric shock or burn.
- To avoid unexpected accident from placing hands or face near the unit during operation.
- Confirm connections to input/output terminals and signal terminals are correct as indicated in the instruction manual.
- For acquisition of various Safety Standards and safety improvement, be sure to use an external fuse.
- This product is designed for installation on electronic equip-

ment.

- For input terminals of 24 V input models, apply a voltage from a primary source with reinforced or double insulation.
- Output voltage of this product is considered to have hazardous energy level (voltage of 2V and above with power of 240W and above) and must not have physical contact with operator. Protection must be provided on this module when installed on equipment to prevent physical contact with service technician himself or accidentally dropped tools during repair. Before repair, be sure to turn off the input source and confirm that input and output voltage have drop down to a safe level.
- Application circuit or component values described in this instruction manual are for reference only. When designing circuit, be sure to verify actual circuit operation before determining final application circuit or component values.
- Contents of this instruction manual are subject to change without notice. When using this product, please refer to latest data sheet to satisfy this product specification.
- No part of this document may be copied or reproduced in any form, or by any means without prior written consent of Denset-Lambda.

PAH

1. Terminal Explanation

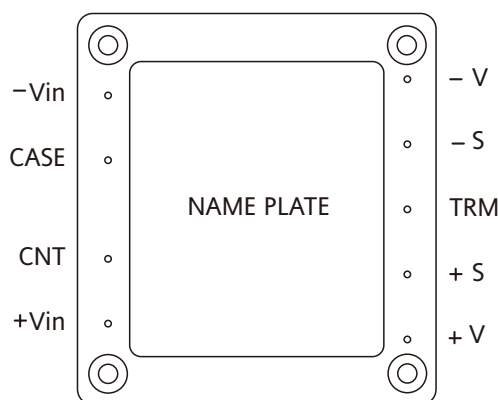

[Input Side Terminals]

-Vin: -Input Terminal
CASE: Baseplate Terminal
CNT: ON/OFF Control Terminal
+Vin: +Input Terminal

[Output Side Terminals]

-V: -Output Terminal
-S: -Remote Sensing Terminal
TRM: Output Voltage Trimming Terminal
+S: +Remote Sensing Terminal
+V: +Output Terminal

Baseplate can be connected to FG (frame ground) M3 threaded holes (standard model).
Connect +Vin, -Vin, +V, -V with consideration of contacting resistance.

2. Explanations on Specifications

1 Input Voltage Range

Input voltage range for PAH300, 350S24 Series is indicated below.

Input Voltage Range: 18 - 36VDC

Basically, ripple voltage (V_{rpl}) which results from rectification and filtering of commercial AC line is included within the input voltage as shown in fig. 1-1. Ripple voltage must be limited within the voltage described below.

Allowable input ripple voltage: 2Vp-p

When this value is exceeded, the output ripple voltage becomes large.

Note that sudden input voltage change may cause variation of output voltage transitionally.

Also, input voltage waveform peak value must not exceed above input voltage range.

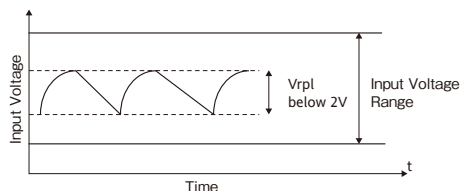

Fig.1-1 Input Ripple Voltage

Basic Connection

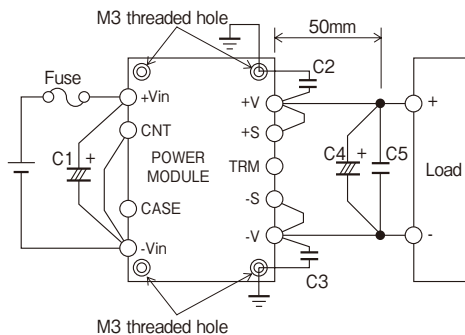

Fig.1-2 Basic Connection

Input Fuse

This power module has no built-in fuse. Use external fuse to acquire various Safety Standards and to improve safety. Also, use fast-blow type for every module.

Furthermore, fuse must be connected to the +Vin side if -Vin side is used as ground, or fuse must be connected to -Vin side if +Vin side is used as a ground.

Input Fuse recommended current rating:

PAH300S24: 30A

PAH350S24: 40A

C1:

To prevent the effect of input line inductance to the power module, connect electrolytic capacitor or ceramic capacitor between +Vin and -Vin terminals.

Furthermore, use electrolytic capacitor with small ESR value. Especially take note that during line turn off at low ambient temperature, power module output will not nor-

mally shut down due to unstable C1 voltage.

Also, ripple current flows across this capacitor. Therefore, verify maximum allowable ripple current this capacitor when selecting component. Verify actual ripple current value by actual measurement.

**Recommended capacitor value: 220 μ F \times 2pcs and above
(Parallel connect)
(Voltage Rating 50V and above)**

Notes

1. Use low impedance electrolytic capacitor with excellent temperature characteristics.
(Nippon Chemi-con LXY Series or equivalent)
2. When input line inductance becomes excessively high due to insertion of choke coil, operation of the power module could become unstable. For this case, increase C1 value more than the value indicated above.
3. When ambient temperature becomes lower than -20°C , connect 4 more and above capacitors indicated above in parallel to reduce ESR.

C2, C3: 0.022 μ F

To reduce spike noise voltage at the output, connect film capacitors or ceramic capacitors between +V and the nearest M3 threaded hole and between -V and the nearest M3 threaded hole.

Also, take note that output spike noise voltage could vary according to PCB (printed circuit board) wiring design.

However, for cases where baseplate is connected to +V or -V, use the nearest M3 threaded hole. (M3 threaded holes is internally connected to baseplate inside the Power Module.) For this type of connection, C2 and C3 can be omitted.

C4:

For stable operation, connect an electrolytic capacitor between +V and -V at 50mm distance from the output terminals.

Take note that output ripple and output shutdown could be affected by electrolytic capacitor, equivalent impedance and inductance characteristics of wiring.

Take note that output ripple voltage could vary according to PCB wiring design.

For cases of abrupt changes in load current or input voltage, increasing capacitance value of the external capacitors could reduce the voltage fluctuation.

Vout	C4
12V	25V 470 μ F
28V	50V 220 μ F

Table1-1 C4: Recommended Values of External Output Capacitor

Notes

1. Use low impedance electrolytic capacitor with excellent temperature characteristics.
(Nippon Chemi-con LXY Series or equivalent)
2. Use three capacitors indicated above in parallel when ambient temperature becomes lower than -20°C to reduce ESR.

- Take note of the allowable ripple current of the capacitor to be used. Especially, when load adding capacitors for abrupt current changes, be sure to verify that ripple current does not exceed allowable ripple current before use.

C5: 0.1 μF

To reduce spike noise voltage at the output, connect a ceramic capacitor between +V and -V within 50mm distance from the output terminals.

Also, take note that output spike noise voltage could vary according to PCB wiring design.

C6:

When switches or connectors are used between input source and PAH300, 350S24 Series input terminals, impulse surge voltage is generated due to input throw-in by switch on/off or due to inserting/removing of power module from the active line. For this case, connect an additional electrolytic capacitor C6 as shown in fig.1-3 and fig. 1-4.

**Recommended Capacitance Value : 220 μF and above
(Voltage Rating 50V and above)**

Also, in-rush current flows at line throw-in. Therefore, be sure to verify capability of switch or fuse to withstand I^2t at line throw-in.

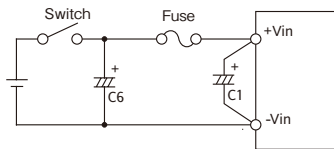

Fig.1-3 Input Filter with Input Switch

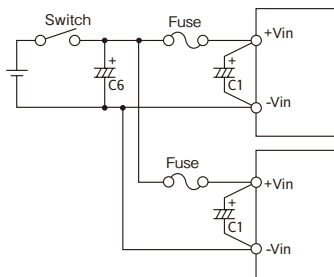

Fig.1-4 Input Filter when Plural Power Modules

Reverse input connection

Reverse input polarity would cause module damage. For cases where reverse connections are possible, connect a protective diode and fuse. Use protective diode with higher voltage rating than the input voltage, and with higher surge current rating than the fuse.

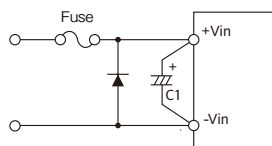

Fig.1-5 Protection for Reversed Connection of Input

● **Recommended input filter as EMI countermeasure**
(conforms to VCCI Class 1, FCC class A)

- (1) Recommended input filter as EMI countermeasure

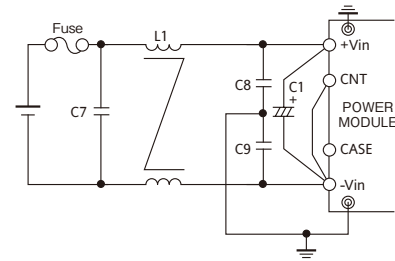

Fig.1-6 Recommended input filter as EMI countermeasure

Recommended Values:

- C1: 680 μF (Electrolytic Capacitor) 3 pcs in parallel
- C7: 10 μF (Ceramic Capacitor)
- C8,C9: 0.47 μF (Film Capacitor)
- L1: 1mH (Common-mode choke coil)

Notes

- For the power module output, connect output capacitors described in the basic circuit connection.
- C1 (electrolytic capacitor) value can be reduced if impedance of input line is lower and operation of power module is stable.
- VCCI Class 1, FCC Class A limits can be satisfied with the above recommended filter at Densai-Lambda measuring conditions. However, there are cases where above limits might not be satisfied due to input and output wiring method, as well as, peripheral circuits. When selecting input filter, be sure to verify actual EMI characteristics (CE and RE) before finalizing the filter. Refer to PAH300, 350S24-* Evaluation Data for details.



2 Output Voltage Adjustment Range

Output voltage could be adjusted within the range described below by external resistor or variable resistor. However, take note that OVP might trigger when output voltage adjustment exceeds the ranges indicated below.

Output Voltage Adjustment Range

- 12V: -40% to +10% of nominal output Voltage
- 28V: -40% to +18% of nominal output Voltage

When increasing the output voltage, reduce the output current accordingly so as not to exceed the maximum output power.

Take note that input voltage range is limited as shown in fig.2-1 when output voltage is increased.

Remote sensing is possible even when output voltage is varied. For details on remote sensing function, please refer to "9. Remote Sensing".

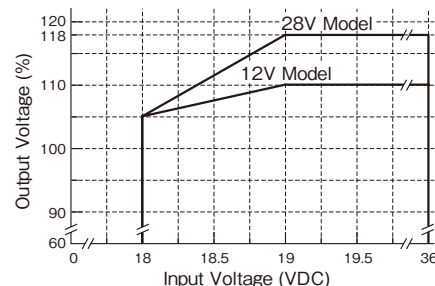

Fig.2-1 Limit of Input Voltage

●Output Voltage Adjustment by external resistor or by variable resistor

- (1) In case of adjusting output voltage lower
 - (1-1) Available maximum output current = rated output current
 - (1-2) Connect an external resistor Radj (down) between the TRM terminal and -S terminal.

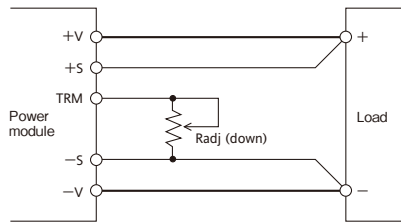

Fig.2-2 Connection for output voltage trim down

- (1-3) Equation of external resistor and output voltage.

$$R_{adj}(\text{down}) = \left[\frac{100\%}{\Delta\%} - 2 \right] [\text{k}\Omega]$$

Radj (down) : Value of external resistor
 Δ(%) : Output voltage change rate against nominal output voltage

Below graph is relation Δ(%) and value of external resistor.

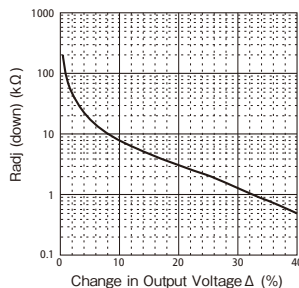

Fig.2-3 Δ(%) vs. Radj (down) (1)

- (2) In case of adjusting output voltage higher
 - (2-1) Allowable maximum output current = maximum output power ÷ output voltage (reduce maximum output current in specification.)
 - (2-2) Connect an external resistor Radj (up) between TRM terminal and +S terminal.

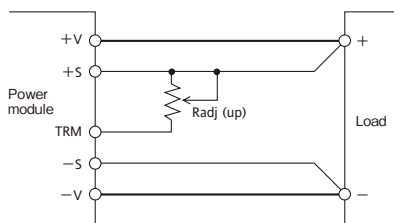

Fig.2-4 Connection for output voltage trim up

- (2-3) Equation of external resistor and output voltage

$$R_{adj}(\text{up}) = \left[\frac{V_o(100\% + \Delta\%)}{1.225 \times \Delta\%} - \frac{100\% + 2 \times \Delta\%}{\Delta\%} \right] [\text{k}\Omega]$$

Vo: Nominal output value of module
 Radj(up): External adjustment resistor
 Δ(%) : Output voltage change rate against nominal output voltage

Below graph is relation Δ(%) and value of external resistor.

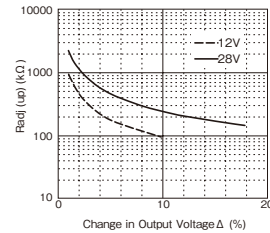

Fig.2-5 Δ% vs. Radj (up) (2)

3 Maximum Ripple and Noise

Measured value according to the specified methods based on JEITA-9141 (Clause 7.12 and clause 7.13) which is described in the following.

Connect according to fig.3-1 and measure. Connect capacitors (C2, C3: film capacitor or ceramic capacitor 0.022μF) between output terminals and the nearest M3 threaded hole. Connect capacitors (C4: refer to table 1-1 for electrolytic capacitor values, C5: ceramic capacitor 0.1μF) at 50mm distance from the output terminals. Measure at ceramic capacitor (C5) terminals as shown in fig. 3-1 using coaxial cable with JEITA attachment. Use oscilloscope with 100MHz frequency bandwidth or equivalent. Take note that output ripple voltage and output spike noise may vary depending on PCB wiring design. Generally, output ripple voltage and output spike noise can be reduced by increasing capacitance value of external capacitor.

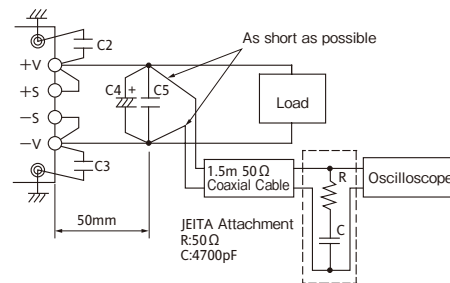

Fig.3-1 Measurement of Maximum Output Ripple & Noise

4 Maximum Line Regulation

Maximum value of output voltage change when input voltage is gradually varied (steady state) within specified input voltage range.

5 Maximum Load Regulation

Maximum value of output voltage change when output current is gradually varied (steady state) within specified output current range.

When using at dynamic load mode, audible noise could be heard from the power module and output voltage fluctuation might increase. A thorough pre-evaluation must be performed before using this power module.

6 Over Current Protection (OCP)

This power module has built-in OCP function. Output will recover when short circuit or overload conditions are released. OCP setting value is fixed and therefore, cannot be externally adjusted.

*All specifications are subject to change without notice.

Also, take note that power module might be damaged continuing output short circuit or over load conditions depending on thermal conditions.

7 Over Voltage Protection (OVP)

This power module has built-in OVP function. OVP set point is relative to the rated output voltage value. OVP setting value is fixed and therefore, can not be externally adjusted.

When OVP is triggered, output can be recovered by turning input line off and then turning it on again after lowering the input voltage below the voltage value indicated below, or by manual reset of the CNT terminal. Reset time for CNT terminal is 100ms or longer.

OVP release input voltage value: 3VDC and below

When verifying OVP function by applying external voltage at the output terminals, applied voltage value should not exceed specified OVP maximum value. Refer to specification table for OVP maximum value. Avoid applying external voltage that exceeds OVP maximum value because this will cause power module damage.

8 Over Temperature Protection (OTP)

This power module has built-in OTP function. This function operates and shuts down the output when ambient temperature or internal temperature of power module abnormally rises. OTP operates at 105°C to 130°C baseplate temperature. OTP can be released when baseplate temperature drops down approximately to within 80°C to 95°C. However, take note that OTP will operate again unless the cause of abnormal heat of the power module is eliminated.

9 Remote Sensing (+S, -S terminal)

Remote sensing terminal is provided to compensate for voltage drop across the wirings from the power module output terminal to the load input terminal.

When remote sensing function is not used (local sensing), short +S terminal to +V terminal and, -S terminal to -V terminal.

Take note that voltage compensation range for line drop (voltage drop due to wiring) is determined such that output voltage at the output terminals is within output voltage range and that voltage between -V and -S terminals is within 2V or less. Even for remote sensing case, use power module such that output power is within specified maximum output power.

Furthermore, reduce noise effect by using shield wire, twist pair, or parallel pattern.

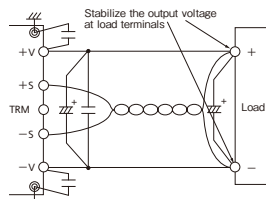

Fig.9-1 Remote Sensing is in Use

* All specifications are subject to change without notice.

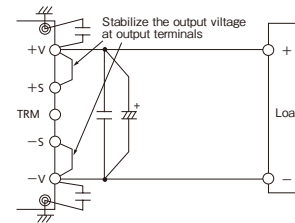

Fig.9-2 Remote Sensing is Not in Use

10 ON/OFF Control (CNT terminal)

Without turning the input supply on and off, the output can be enabled and disabled using this function. This function also can be used for output sequence of plural power modules.

There are two kinds of logic control, negative logic control and positive logic control, depend on the option selected. ON/OFF control circuit is on the primary side (the input side). For secondary control, isolation can be achieved through the use of an opto-coupler or relay.

	Logic	CNT Terminal Level to -Vin Terminal	Output status
Standard /T option	Negative Logic	H Level ($4V \leq H \leq 35V$) or Open	OFF
		L Level ($0V \leq L \leq 0.8V$) or Short	ON
/P option /PT option	Positive Logic	H Level ($4V \leq H \leq 35V$) or Open	ON
		L Level ($0V \leq L \leq 0.8V$) or Short	OFF

PAH

Notes

- When ON/OFF control function is not used for the Standard and /T option, CNT terminal should be shorted to -Vin terminal.
- When ON/OFF control function is not used for the /P option and /PT option, CNT terminal should be opened.
- When using long wiring, for prevention of noise, attach a 0.1μF capacitor between CNT terminal and -Vin terminal.
- At L level, maximum source current from CNT terminal to -Vin terminal is 0.5mA
- The maximum CNT terminal voltage is 35V.

(1) Output ON/OFF control

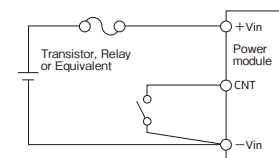

Fig.10-1 CNT Connection (1)

(2) Secondary (output side) control

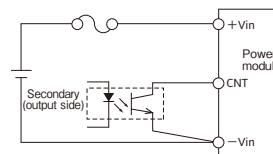

Fig.10-2 CNT Connection (2)

11 Parallel Operation

Parallel Operation can not be used.

12 Series Operation

Series operation is possible for PAH300, 350S24 series. Connections shown fig. 12-1 and fig. 12-2 are possible.

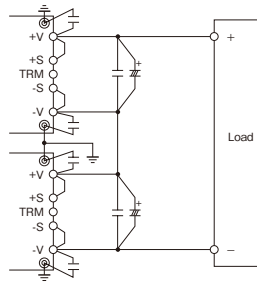

Fig.12-1 Series Operation due to High Output Voltage

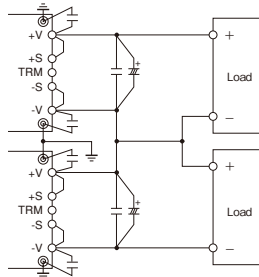

Fig.12-2 Series Operation due to ±Output

PAH

13 Operating Ambient Temperature

There is no restriction on mounting direction but there should be enough consideration for airflow so that heat does not accumulate around the power module vicinity. Determine external components configuration and mounting direction on PCB such that air could flow through the heatsink at forced cooling and conventional cooling. By maintaining actual baseplate temperature below 100°C, operation is possible.

For details on thermal design, refer to Application Notes "Thermal Design".

Note :

Maximum baseplate temperature is 100°C. For worst case operating condition, verify baseplate temperature at measurement point indicated in fig. 13-1.

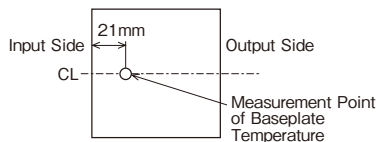

Fig.13-1 Measurement Point of Baseplate Temperature

For better improvement of power module reliability, derating of baseplate temperature when using is recommended.

14 Operating Ambient Humidity

Take note that moisture could lead to power module abnormal operation or damage.

15 Storage Ambient Temperature

Abrupt temperature change would cause moisture formation that leads to poor solderability of each terminal of the power module.

16 Storage Ambient Humidity

Take enough care when storing the power module because rust which causes poor solderability would form in each terminal when stored in high temperature, high humidity environment.

17 Cooling Method

Operating temperature range is specified by the baseplate temperature. Therefore, several methods of heat dissipation are possible.

For details on thermal design, refer to Application Notes "Thermal Design".

18 Baseplate Temperature vs. Output Voltage Drift

Output voltage drift is defined as the rate of voltage change when baseplate temperature only is changed during operation.

19 Withstand Voltage

This power module is designed to have a withstand voltage of 1.5kVDC between input and baseplate, 1.5kVDC between input and output and 500VDC between output and baseplate for 1 minute. When conducting withstand voltage test during incoming inspection, be sure to apply DC voltage. Also, set the current limit value of the withstand voltage testing equipment to 10mA.

Be sure to avoid conducting test with AC voltage because this would cause power module damage.

Furthermore, avoid throw in or shut off of the testing equipment when applying or when shutting down the test voltage. Instead, gradually increase or decrease the applied voltage. Take note especially not to use the timer of the test equipment because when the timer switches the applied voltage off, impulse voltage which has several times the magnitude of the applied voltage is generated causing damage to the power module.

Connect the terminals as shown in the diagram below.

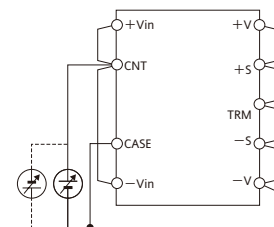

Withstand voltage Tester
1.5kVDC 1 minute (10mA)

Fig.19-1 Withstand Voltage Test for Input-Output and Input-Baseplate

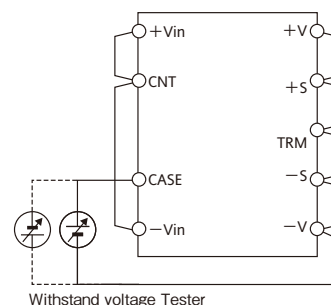

Withstand voltage Tester
500VDC 1minute (10mA)

Fig.19-2 Withstand Voltage Test for Output-Baseplate

20 Isolation Resistance

Use DC isolation tester (MAX 500V) between output and baseplate. Isolation resistance value is 100M Ω and above at 500VDC applied voltage. Also take note that depending on the isolation tester used, some testers generate high voltage pulse. Discharge the power module after test using a resistor, etc.

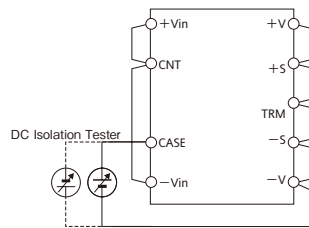

Over 100M Ω at 500VDC
Fig.20-1 Isolation Test

21 Vibration

Vibration of power module is defined in case of mounting on printed circuit board.

22 Shock

Withstand shock value is defined to be the value at Den-sei -Lambda shipment and packaging conditions.

23 Others

Please refer to "Power Module Application Note" for thermal design and mounting direction.

3. Before concluding power module damage

Verify following items before concluding power module damage.

1) No output voltage

- Is specified input voltage applied?
- Are the ON/OFF control terminal (CNT), remote sensing terminal (+S, -S), output voltage trimming terminal (TRM) correctly connected?
- For cases where output voltage adjustment is used, is the resistor or variable resistor setting, connections correctly done?
- Are there no abnormalities in the output load used?
- Is the baseplate temperature within the specified temperature range?

2) Output voltage is high

- Are the remote sensing terminals (+S, -S) correctly connected?
- Is the measurement done at the sensing points?
- For cases where output voltage adjustment is used, is the resistor or volume setting, connections correctly done?

3) Output voltage is low

- Is specified input voltage applied?
- Are the remote sensing terminals (+S, -S) correctly connected?
- Is the measurement done at the sensing points?
- For cases where output voltage adjustment is used, is the resistor or variable resistor setting, connections correctly done?
- Are there no abnormalities in the output load used?

4) Load regulation and line regulation is large





- Is specified input voltage applied?
- Are the input terminals and the output terminals firmly connected?
- Is the measurement done at the sensing points?
- Is the input or output wire too thin?

5) Output ripple voltage is large

- Is the measuring method used the same or equivalent with the specified method in the Application Notes?
- Is the input ripple voltage value within the specified value?

PAH

PAH-S48 SERIES Instruction Manual

- PAH300S24, 350S24 Instruction Manual  B-175Page
- PAH300S48, 350S48 Instruction Manual  B-189Page
- PAH450S48 Instruction Manual  B-196Page
 - PAH75D Instruction Manual  B-204Page
 - PAH200H Instruction Manual  B-216Page

Before Using This Power Module

Pay attention to all warnings and cautions before using this unit. Incorrect usage could lead to an electric shock, damage to the unit, or a fire hazard. Be sure to read below warnings and cautions before using the power module.

Warning

- Do not touch heatsink and case which may be hot.
- Do not open the case and touch the internal components. They may have high temperature or high voltage which may get you in electric shock or burned.
- When the unit is operating, keep your hands and face away from the unit. You may get injured by an accident.

Caution

- Confirm connections to input/output terminals and signal terminals are correct as indicated in the instruction manual.
- Attach a fast blow type external fuse to each module to ensure safety operation and to acquire each safety standard approval.

- This power module is designed for professional installation within an end user equipment.
- Use isolated voltage by reinforced insulation at primary power supply or double insulation as input power source.
- The output from this power module must be considered as an energy hazard (> 240VA power and 2V voltage) and must not be accessible to an end user. End equipment manufacturers must provide protection against inadvertent contact with the output terminals on this product by a service engineer or by service engineer dropping a tool into them.
- The application circuits and their parameter are for reference only. Be sure to verify effectiveness of application circuits and their parameters before finalizing circuit design.
- The information in this document is subject to change without notice. For actual design-in, please refer to the latest publications of data sheet, etc., for the most up-to-date specifications of the unit.
- No part of this document may be copied or reproduced in any form or by any mean without prior written consent of Densel-Lambda.

PAH

1. Terminal Pin Configurations

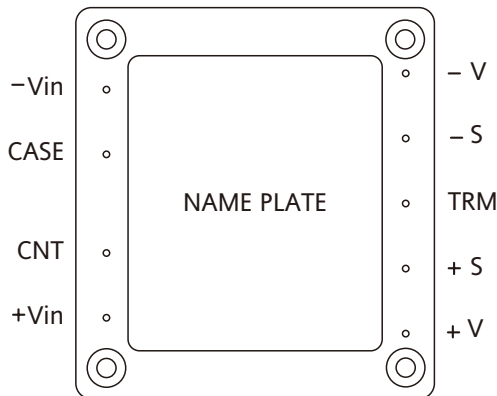

- Vin: Negative Input Terminal
- CASE: Baseplate Terminal
- CNT: ON/OFF Control Terminal
- +Vin: Positive Output Terminal
- V: Negative Output Terminal
- S: Negative Remote Sensing
- TRM: Output Voltage Adjustment Terminal
- +S: Positive Remote Sensing
- +V: Positive Output Terminal

Basic connection

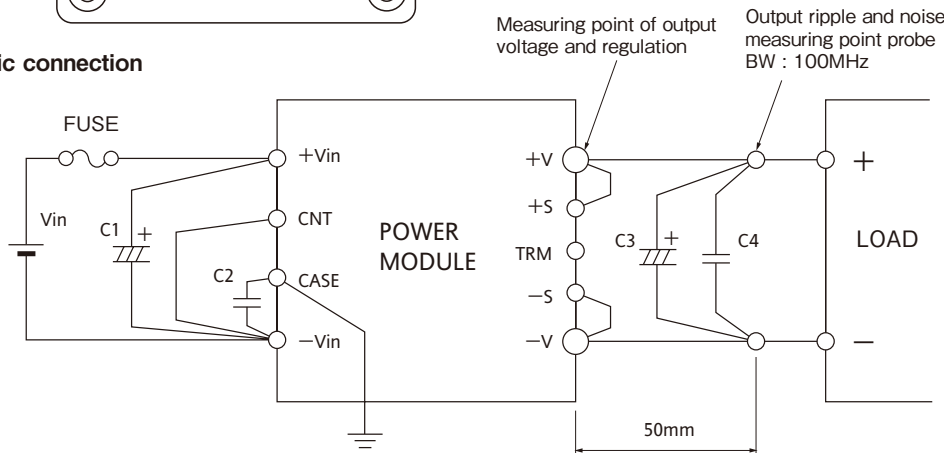

Note : This diagram is for Negative Logic "ON/OFF" Option.

1 External Components

The table below shows the recommended values for the external components above.

Item	Model	2.5	3.3	5	12	15	24	28
F1	200S	250V 15A						
	150S	250V 10A						
	100S	250V 7A						
	75S	250V 5A						
	50S	250V 5A						
		(UL approved and fast acting)						
C1 *	All	Electrolytic capacitor: 100V 33uF						
C2	All	Ceramic capacitor: 2KVAC 4700pF						
C3 *	200S				1000uF	1000uF	470uF	470uF
	150S	2200uF	2200uF	2200uF	470uF	470uF	220uF	220uF
	100S							
	75S							
	50S							
C4 *	All	Ceramic capacitor: 50V 1uF						

* (1) The above value is for operating temperature range from -20°C to 100°C.

- For -40°C to 100°C range, change C1 to ceramic type of capacitor and use 2 capacitors for C3.
- Use low ESR type E-Cap for C1 and C3 such as KME series for C1 and LXY series of Nippon Chemi-Con for C3.
- Only for 200W model; -40°C to 100°C operation, C4 is increased to 10uF ceramic cap.

PAH-S48 SERIES module is not internally fused. To ensure safe operation and to receive each safety standard approval, please connect an external fuse, F1 as shown in the diagram above.

Input capacitor C1 is recommended to stabilize the module when the module is powered from a high impedance source.

Capacitor C2 is used to absorb noise coming from the module itself. This capacitor will also help the EMI performance of the module.

The function of capacitor C3 is to reduce the output ripple of the power module whereas the capacitor C4 is to reduce high frequency noise that is produced by the module.

If in any application where an input reversal connection is possible, a protective diode that is connected across +Vin and -Vin is recommended.



2. Explanations on Specifications

1 Input Voltage Range

The operating input voltage range of PAH-S48 SERIES is 36~76VDC. The maximum allowable input ripple voltage (Vrpl) is 4V. Any ripple that exceeds this value might cause the module to become unstable.

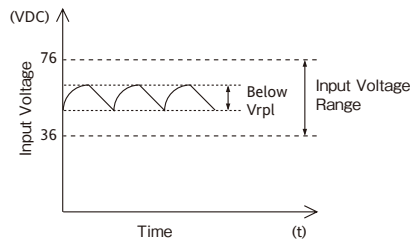

Protection for input reverse connection

Please connect protection diode and a fuse as shown below.

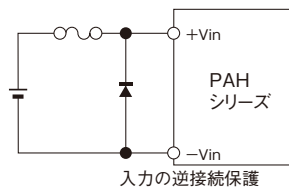

2 Output Voltage Adjust Range

The output voltage of power module can be adjusted by connecting an external resistor (R_{adj}) between the TRIM pin and either the +S or -S pins. With an external resistor (R_{adj}) between TRIM pin and -S pin, output voltage will decrease

as shown in diagram below.

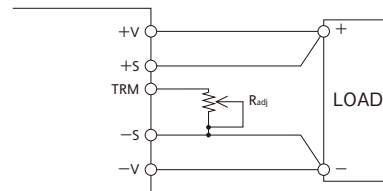

The equation shown below determines the required external resistor (R_{adj}) value to obtain a percentage output voltage change of Δ%.

$$R_{adj}(\text{down}) = \left(\frac{100\%}{\Delta\%} - 2 \right) \text{ k}\Omega$$

The graph shown below the external resistor (R_{adj}) value against a percentage output voltage change of Δ%.

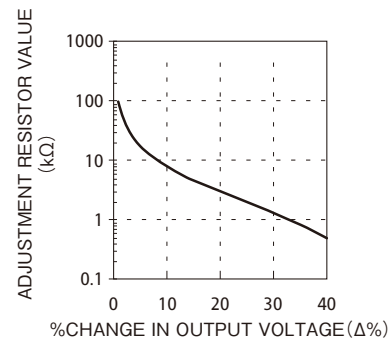

If the external resistor (R_{adj}) is connected between the TRIM pin and +S pin, the output voltage will increase. Diagram shown below is the output voltage trim up connection.

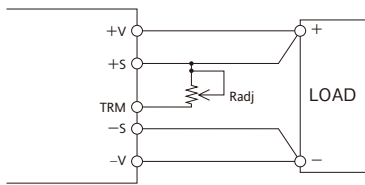

The equation shown below determines the required external resistor (R_{adj}) value to obtain a percentage output voltage change of $\Delta\%$.

$$R_{adj}(up) = \left(\frac{V_o (100\% + \Delta\%)}{1.225 \times \Delta\%} - \frac{(100\% + 2 \times \Delta\%)}{\Delta\%} \right) k\Omega$$

V_o = Nominal output Voltage.

The graph shown is the external resistor (R_{adj}) value against a percentage output voltage change of $\Delta\%$.

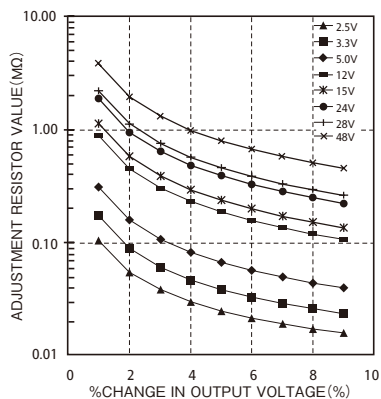

PAH

If the output voltage is raised above its nominal value, the output current needs to be derated to a value such that the output power does not exceed the maximum output power specified in the specification sheet. In addition to that, there is also a limitation to the input voltage range for the 5V version only which is as shown below.

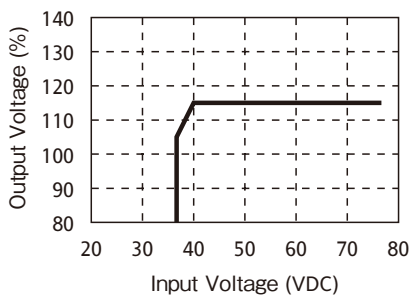

3 Output Ripple & Noise Measurement Method

The method for output ripple and noise are based upon JEITA RC-9002A. Upon measurement of the ripple voltage, make sure that the oscilloscope probe leads are not too long.

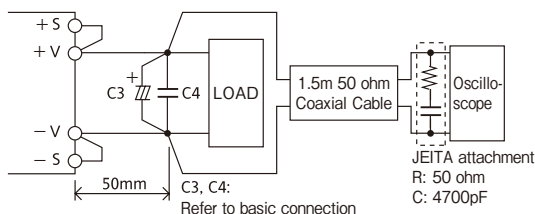

4 Maximum Line Regulation

Maximum line regulation is the maximum output voltage change when the input voltage is slowly varied within the input voltage range. The measurement point for the input and output voltage are $\pm V_{in}$ and $\pm S$ (sensing point) respectively.

5 Maximum load regulation

Maximum load regulation is the maximum output voltage value change when varying the load current slowly within the standard output current range. The measurement point for the input and output voltages are $\pm V_{in}$ and $\pm S$ (sense point) respectively.

6 Brownout

There will be output voltage overshoot during brown-out (momentary input line off) condition.

7 Over Current Protection

The PAH-S48 SERIES is equipped with an over current protection circuit. When the short or overload condition is removed, the output will automatically recover. This setting is fixed and cannot be varied externally. If the short or overload condition continues, the power module could be damaged due to the heat condition.

8 Over Voltage Protection

There are 2 types of over protection method available for the PAH series. In the standard model, a latching shutdown method is adopted. For this method there are two ways to reset the power module after OVP protection triggers. They are by (i) giving a pulse to the control pin or (ii) recycling the input voltage. In the /V optional model, the power module will shutdown after OVP protection triggers but will recover automatically when over voltage is removed.

9 Thermal Protection

The PAH-S48 SERIES have a thermal protection circuit that sense the baseplate temperature between the range of 105°C to 130°C for an over temperature condition. Under a condition where the ambient temperature or the power module internal temperature rises excessively, the thermal protection circuit will shut down the power module. The power module will recover automatically when the baseplate temperature cools down.

10 Remote Sensing

The PAH-S48 SERIES is equipped with remote sensing terminals, which compensate for the voltage drops between the power supply output terminals and the load terminals. Remote sensing should be performed at the load. When remote sensing is not required (local sensing), short the +S with the +V terminal, and the -S with the -V terminal. The

compensation range should be kept so that the output voltage is within the output voltage range and the maximum power is not exceeded. For long connections and noise sensitive environments, shielded wires are recommended to minimize noise pickup on the output leads.

Remote Sensing in Use

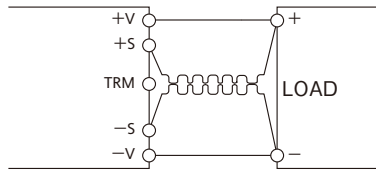

Remote Sensing not in Use

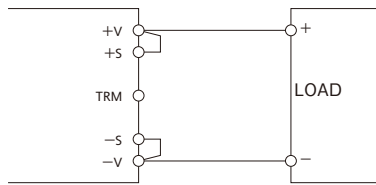

11 ON /OFF Control (CNT)

Without turning the input supply on and off, the output can be enabled and disabled using this function. This control circuit is on the input side of the power module; CNT terminal pin. There are two options available in this function, which are Negative Logic and Positive Logic. In the standard model where Negative Logic is used, the power module will turn on when CNT terminal pin is shorted to -Vin or a low logic voltage is provided. The power module will turn off when CNT pin is open or Logic high is provided. In the /P optional model where Positive logic is used, the control method is vice versa to the Negative Logic.

Below tables summarize the CNT levels and output states with different logic types.

a) Negative Logic: (Standard model)

CNT Level to -Vin	OUTPUT
H (more than 2.0V) or Open	OFF
L (less than 1.0V) or Short	ON

b) Positive Logic: (/P option)

CNT Level to -Vin	OUTPUT
H (more than 2.0V) or Open	ON
L (less than 1.0V) or Short	OFF

The maximum CNT pin voltage when it is opened is 7V. The maximum low logic sourcing current is 0.6mA. When using this function, attach a 0.1μF capacitor between the CNT and -Vin terminals.

Remote ON/OFF control can also be exercised by opening or closing the contacts of a switch or relay, or by operating a transistor as a switch in series with the CNT terminal.

Standard remote ON/OFF control circuit is provided in

the primary circuit. For secondary control, isolation can be achieved through use of an opto-coupler or relay.

CNT Connection Method

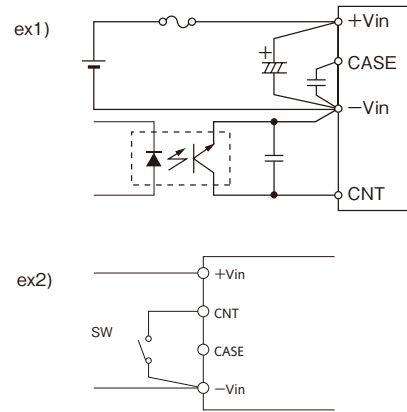

12 Series Operation

All PAH-S48 SERIES modules allow series operation with any combination of output voltages. Please contact us for maximum number of connections possible.



- (1) Series Operation for High Output Voltage Applications
When using PAH-S48 SERIES modules in a high output voltage configuration external bypassing diodes need to be connected to either module.

- a. Peak Reverse Voltage
VRRM > 2x the power module output voltage
- b. Average Output Current
Io > Twice the power module output current
- c. Forward Voltage
VF = Minimum (Schottky Barrier Type, etc)

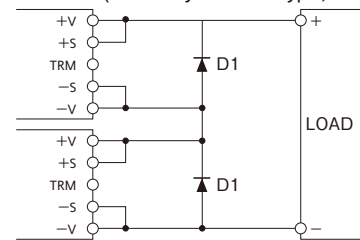

- 2) +/- Output Series Operation

When the load on the positive side is isolated from the load on the negative side, the following connection hookup is recommended.

Bypassing diodes are not needed when operate in this mode.

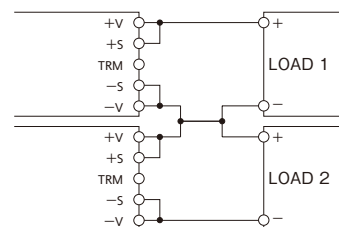

13 Operation Temperature

The baseplate temperature range for PAH-S48 SERIES is from -40°C to 100°C .

14 Operation Humidity

Avoid the buildup of condensation on or in the power module.

15 Storage Temperature

Please note that sudden temperature changes can cause condensation buildup, and other harmful affects to each terminal solder.

16 Storage Humidity

High temperature and humidity can cause the terminals on the module to oxidize. The quality of the solder will become worse.

PAH

17 Cooling Method

The operating temperature is specified by the baseplate temperature. Various cooling methods are possible such as using heatsink or chassis of the equipment. If the temperature is very high, fan is recommended.

18 Parallel Operation

PAH series are not available for parallel operation.

19 Baseplate Temperature vs. Output Regulation

This is the output voltage change ratio when varying the baseplate operation temperature.

20 Withstand Voltage

The power module is designed to withstand 1.5kVAC between the input to the baseplate and input to output for 1 minute. In the case that the withstanding voltage is tested in the incoming goods test, etc., please set the limit of the test equipment to 20mA. The applied voltage must be increased gradually from zero to the testing value, and then decreased gradually at shutdown. Do not use a timer where a pulse of several times the applied voltage can be generated. This could cause damage to the module. Be sure to short all the input and output pins as shown below.

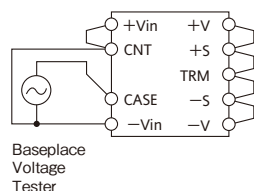

Input - Baseplate
1.5kVAC 1 min. (20mA)

Note : Please be sure to short all the input & output pins as shown above.

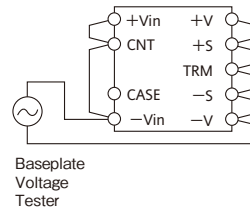

Input - Output
1.5kVAC 1 min.(20mA)

Note : Please be sure CASE is not shorted to any pins.

21 Isolation Resistance

The isolation resistance is more than 100MΩ at 500VDC when tested with a DC isolation tester between the output and the baseplate. Make sure that during testing, the isolation testers do not produce a high pulse when the applied voltage is varied. Ensure that the tester is fully discharged after the test.

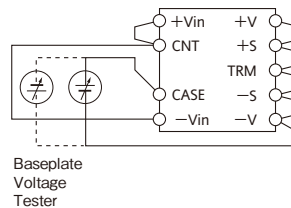

22 Vibration

Please refer to the power module mounting in the PAH-S48 series handbook in order to achieve vibration level stated in the specification.

23 Shock

Value for the conditions of our shipping and packaging.

24 Others

The performance of a system with Power Module is influenced according to various conditions -- PCBs, chassis, mechanics, heat dissipation.

Please evaluate actual products, and confirm its performance.

Please refer to "Power Module Application Note" for thermal design and mounting direction.

3. Mounting Direction

1 Circuit Board Mounting

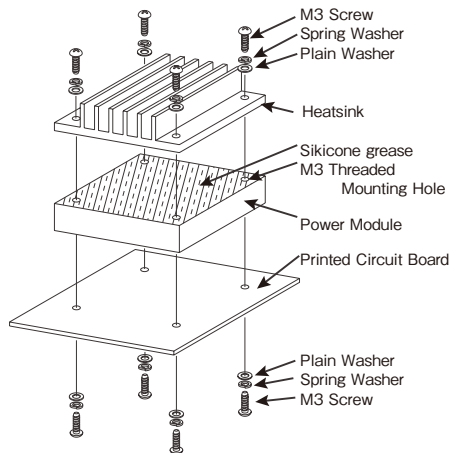

Fig.1-1 Mounting method for standard model

- (1) The power module is fixed to printed circuit board by 4 positions through the M3 tapped holes in the resin case side. Recommended torque is 5.5kgcm.
- (2) The M3 mounting tapped holes of the power module are connected to the baseplate. FG (Frame Ground) can be taken by these tapped holes.
- (3) Mounting Holes on Printed Circuit Board
 - Input/Signal/Output Terminal Pin (ϕ 1.0mm)
 - Hole Diameter : ϕ 1.5 mm
 - Land Diameter : ϕ 3.5 mm
 - Output terminal Pin (ϕ 2.0 mm)
 - Hole Diameter : ϕ 2.5 mm
 - Land Diameter : ϕ 5.0 mm
 - M3 Mounting Tap (FG)
 - Hole Diameter : ϕ 3.5 mm
 - Land Diameter : ϕ 7.0 mm
- (4) Recommended Printed Circuit Board is a double sided glass epoxy ($t=1.6\text{mm}$) with through holes.
- (5) The standard power module lead length is 5.08mm.

2 Recommended Soldering Condition

Recommended soldering temperature is as follows.

- (1) Soldering dip : 260°C within 10 seconds
Pre-heat condition : 110°C 30~40 seconds
- (2) Soldering iron : 350°C within 3 seconds

3 Recommended Cleaning Condition

Recommended cleaning condition after soldering is as follows.

- Cleaning solvent : IPA (isopropyl alcohol)
- Cleaning Procedure : Use brush and dry the solvent completely

Note : For other cleaning methods, contact us.

4 Heatsink Installation

- 1) The power module is fixed to the heatsink by 4 position through the M3 mounting tapped holes provided on the baseplate. It is recommended that the sequence to screw the 4 screws is in a diagonally manner and the recommended torque is 5.5kgcm.
- 2) Recommended hole diameter for heatsink = 3.5mm.
- 3) Use thermal grease or thermal sheet in between heatsink and baseplate to minimize the contact thermal resistance. However, make sure that the thermal grease or sheet is evenly applied and using no-warped heatsink in order to avoid any warpage on the baseplate.
- 4) Recommended thermal sheet is as shown below. Cutting the corner of thermal sheet is NOT advisable.

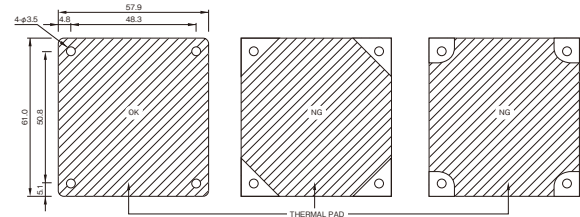

PAH

5 Output Derating

- (i) PAH50S48, PAH75S48, PAH100S48 & PAH150S48

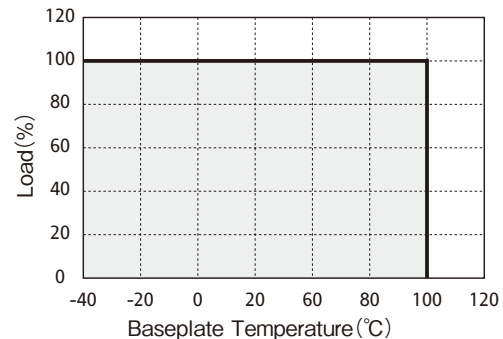

- (ii) PAH200S48

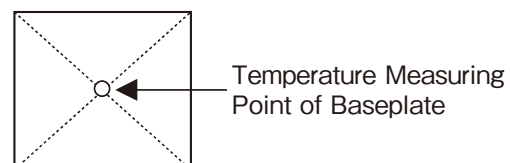
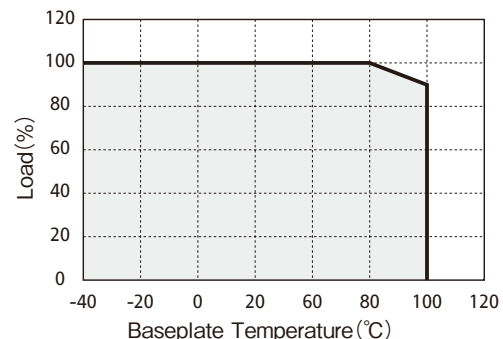

6 External Fuse Rating





Fuse rating : PAH200S48 --- 250V 15A (Fast Blow Type)
PAH150S48 --- 250V 10A (Fast Blow Type)
PAH100S48 --- 250V 7A (Fast Blow Type)
PAH75S48 --- 250V 5A (Fast Blow Type)
PAH50S48 --- 250V 5A (Fast Blow Type)

7 Notes

Over Current Protection operates > 105% of maximum DC output current.

PAH

PAH300, 350S48 SERIES Instruction Manual

- PAH300S24, 350S24 Instruction Manual  B-175Page
- PAH50S48 ~ 200S48 Instruction Manual  B-182Page
- PAH450S48 Instruction Manual  B-196Page
 - PAH75D Instruction Manual  B-204Page
 - PAH200H Instruction Manual  B-216Page

Before using this product

Be sure to take note of precautions and warnings indicated in this manual when using this product. Improper usage may lead to electric shock or fire. Be sure to read this instruction manual thoroughly before using this product.

Precautions

- Avoid touching the baseplate and the case of this product because they get hot.
- There are high voltage and high temperature components within this product. Refrain from disassembling this product or touching its internal components as this may lead to electric shock or burn.
- To avoid unexpected accident from placing hands or face near the unit during operation.
- Verify that connection to input, output and signal terminals are correct as indicated in this instruction manual.
- For acquisition of various Safety Standards and safety improvement, be sure to use an external fuse.
- This product is designed for installation on electronic equipment.
- For input terminals of 48V input models, apply a voltage from a primary source with reinforced or double insulation.

- Output voltage of this product is considered to have hazardous energy level (voltage of 2V and above with power of 240W and above) and must not have physical contact with operator. Protection must be provided on this module when installed on equipment to prevent physical contact with service technician himself or accidentally dropped tools during repair. Before repair, be sure to turn off the input source and confirm that input and output voltage have drop down to a safe level.
- Application circuit or component values described in this instruction manual are for reference only. When designing circuit, be sure to verify actual circuit operation before determining final application circuit or component values.
- Contents of this instruction manual are subject to change without notice. When using this product, please refer to latest data sheet to satisfy this product specification.
- No part of this document may be copied or reproduced in any form, or by any means without prior written consent of Densel-Lambda.

PAH

Note : CE Marking

CE Marking, when applied to a product covered by instruction manual, indicates compliance with the low voltage directive which complies with EN60950.

1. Terminal Explanation

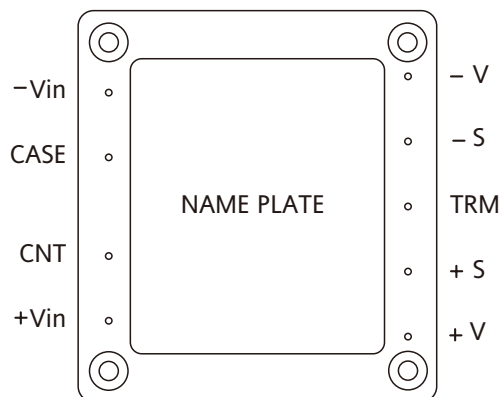

[Input Side Terminals]

-Vin : -Input Terminal
CASE : Baseplate Terminal
CNT : ON/OFF Control Terminal
+Vin : +Input Terminal

[Output Side Terminals]

-V : -Output Terminal
-S : -Remote Sensing Terminal
TRM : Output Voltage Trimming Terminal
+S : +Remote Sensing Terminal
+V : +Output Terminal

Baseplate can be connected to FG (frame ground) M3 threaded holes (standard model).
Connect +Vin, -Vin, +V, -V with consideration of contacting resistance.

2. Explanations on Specifications

1 Input Voltage Range

Input voltage range for PAH300, 350S48 Series is indicated below.

Input Voltage Range: 36 - 76VDC

Basically, ripple voltage (V_{rpl}) which results from rectification and filtering of commercial AC line is included within the input voltage as shown in Fig. 1-1. Ripple voltage must be limited within the voltage described below.

Allowable input ripple voltage: 4Vp-p

When this value is exceeded, the output ripple voltage becomes large.

Note that sudden input voltage change may cause variation of output voltage transitionally.

Also, input voltage waveform peak value must not exceed above input voltage range.

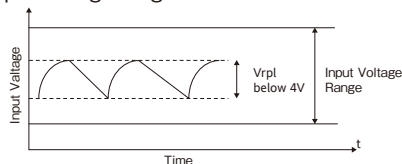

Fig.1-1 Input Ripple Voltage

Basic Connection

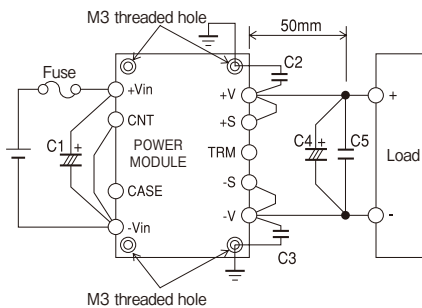

Fig.1-2 Basic Connection

Input Fuse

This power module has no built-in fuse. Use external fuse to acquire various Safety Standards and to improve safety. Also, use fast-blow type for every module.

Furthermore, fuse must be connected to the +Vin side if -Vin side is used as ground, or fuse must be connected to -Vin side if +Vin side is used as a ground.

Input Fuse recommended current rating:

PAH300S48: 15A (F15AH, 125/250V)

PAH350S48: 20A (F20AH, 125/250V)

C1: 33 μ F

To prevent the effect of input line inductance to the power module, connect electrolytic capacitor or ceramic capacitor between +Vin and -Vin terminals.

Furthermore, use electrolytic capacitor with small ESR value. Especially take note that during line turn off at low ambient temperature, power module output will not normally shut down due to unstable C1 voltage.

Also, ripple current flows across this capacitor. Therefore,

verify maximum allowable ripple current this capacitor when selecting component. Verify actual ripple current value by actual measurement.

Recommended capacitor value: 33 μ F and above (Voltage Rating 100V and above)

Notes) 1. Use low impedance electrolytic capacitor with excellent temperature characteristics.

(Nippon Chemi-con LXV Series or equivalent)

2. When input line inductance becomes excessively high due to insertion of choke coil, operation of the power module could become unstable. For this case, increase C1 value more than the value indicated above.

3. When ambient temperature becomes lower than -20°C , connect two capacitors indicated above in parallel to reduce ESR.

C2, C3: 0.022 μ F

To reduce spike noise voltage at the output, connect film capacitors or ceramic capacitors between +V and the nearest M3 threaded hole and between -V and the nearest M3 threaded hole.

Also, take note that output spike noise voltage could vary according to PCB (printed circuit board) wiring design.

However, for cases where baseplate is connected to +V or -V, use the nearest M3 threaded hole. (M3 threaded holes is internally connected to baseplate inside the Power Module.) For this type of connection, C2 and C3 can be omitted.

C4:

For stable operation, connect an electrolytic capacitor between +V and -V at 50mm distance from the output terminals.

Take note that output ripple and output shutdown could be affected by electrolytic capacitor, equivalent impedance and inductance characteristics of wiring.

Take note that output ripple voltage could vary according to PCB wiring design.

For cases of abrupt changes in load current or input voltage, increasing capacitance value of the external capacitors could reduce the voltage fluctuation.

Vout	C4
12V	25V 470 μ F
28V	50V 220 μ F

Table1-1 C4 Recommended Values of External Output Capacitor

Notes) 1. Use low impedance electrolytic capacitor with excellent temperature characteristics.

(Nippon Chemi-con LXY Series or equivalent)

2. Use three capacitors indicated above in parallel when ambient temperature becomes lower than -20°C to reduce ESR.

3. Take note of the allowable ripple current of the capacitor to be used. Especially, when load adding capacitors for abrupt current changes, be sure to verify that ripple current does not exceed allowable ripple current before use.

C5: 0.1μF

To reduce spike noise voltage at the output, connect a ceramic capacitor between +V and -V within 50mm distance from the output terminals.

Also, take note that output spike noise voltage could vary according to PCB wiring design.

C6:

When switches or connectors are used between input source and PAH300, 350S48 Series input terminals, impulse surge voltage is generated due to input throw-in by switch on/off or due to inserting/removing of power module from the active line. For this case, connect an additional electrolytic capacitor C6 as shown in fig.1-3 and fig. 1-4.

**Recommended Capacitance Value: 33μF and above
(Voltage Rating 100V and above)**

Also, in-rush current flows at line throw-in. Therefore, be sure to verify capability of switch or fuse to withstand I^2t at line throw-in.

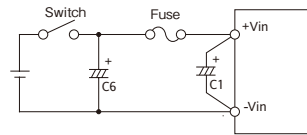

Fig.1-3 Input Filter with Input Switch

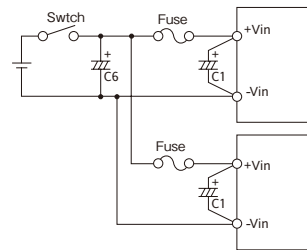

Fig.1-4 Input Filter when Plural Power Modules

Reverse input connection

Reverse input polarity would cause module damage. For cases where reverse connections are possible, connect a protective diode and fuse. Use protective diode with higher voltage rating than the input voltage, and with higher surge current rating than the fuse.

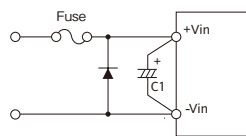

Fig.1-5 Protection for Reversed Connection of Input

Recommended input filter as EMI countermeasure (conforms to VCCI Class 1, FCC class A)

(1) Recommended input filter as EMI countermeasure (1)

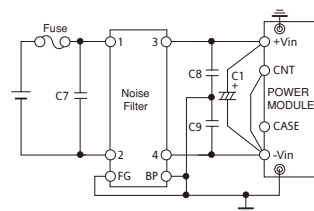

Fig.1-6 Recommended input filter as EMI countermeasure (1)

Recommended Values:

- C1: 470 μF (Electrolytic Capacitor) 3 pcs in parallel
- C7: 4.7 μF (Ceramic Capacitor)
- C8, C9: PAH300S48: 0.22 μF (Film Capacitor)
PAH350S48: 0.33 μF (Film Capacitor)
- Noise filter: PAN4820 (DENSEI-LAMBDA)

(2) Recommended input filter as EMI countermeasure (2)

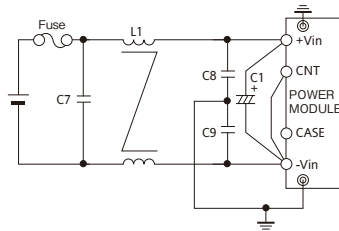

Fig.1-7 Recommended input filter as EMI countermeasure (2)

Recommended Values:

- C1: 470μF (electrolytic capacitor) 3 pcs in parallel
- C7: 4.7μF (ceramic capacitor) 2 pcs in parallel
- C8, C9: PAH300S48 : 0.22 μF (Film Capacitor)
PAH350S48 : 0.33 μF (Film Capacitor)
- L1: 150μH (common-mode choke coil)

- Notes) 1. For the power module output, connect output capacitors described in the basic circuit connection.
2. C1 (electrolytic capacitor) value can be reduced if impedance of input line is lower and operation of power module is stable.
3. VCCI Class 1, FCC Class A limits can be satisfied with the above recommended filter at Densai-Lambda measuring conditions. However, there are cases where above limits might not be satisfied due to input and output wiring method, as well as, peripheral circuits. When selecting input filter, be sure to verify actual EMI characteristics (CE and RE) before finalizing the filter. Refer to PAH300, 350S48-* Evaluation Data for details.

2 Output Voltage Adjustment Range

Output voltage could be adjusted within the range described below by external resistor or variable resistor. However, take note that OVP might trigger when output voltage adjustment exceeds the ranges indicated below.

Output Voltage Adjustment Range

- 12V: -40% to +10% of nominal output Voltage
- 28V: -40% to +18% of nominal output Voltage

When increasing the output voltage, reduce the output current accordingly so as not to exceed the maximum output power.

Take note that input voltage range is limited as shown in fig.2-1 when output voltage is increased.

Remote sensing is possible even when output voltage is varied. For details on remote sensing function, please refer to "9. Remote Sensing".



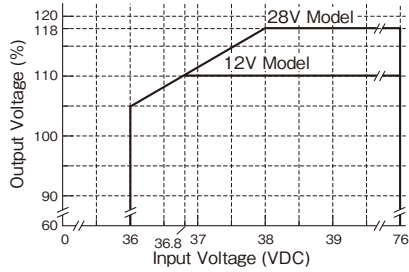

Fig.2-1 Limit of Input Voltage

●Output Voltage Adjustment by external resistor or by variable resistor

- (1) In case of adjusting output voltage lower
 - (1-1) Available maximum output current = rated output current
 - (1-2) Connect an external resistor Radj (down) between the TRM terminal and -S terminal.

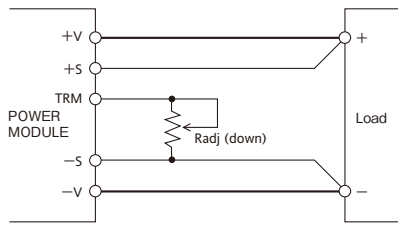

Fig.2-2 Connection for output voltage trim down

- (1-3) Equation of external resistor and output voltage

$$Radj(\text{down}) = \left(\frac{100\%}{\Delta\%} - 2 \right) [k\Omega]$$

Radj(down) : Value of external resistor
 Δ (%): Output voltage change rate against nominal output voltage

Below graph is relation Δ(%) and value of external resistor.

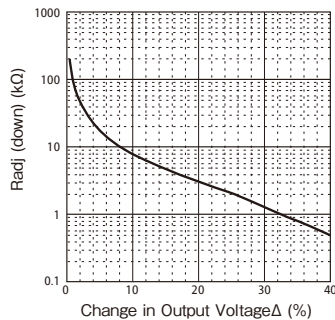

Fig.2-3 Δ (%) vs. Radj (down) (1)

- (2) In case of adjusting output voltage higher
 - (2-1) Allowable maximum output current = maximum output power ÷ output voltage (reduce maximum output current in specification.)
 - (2-2) Connect an external resistor Radj (up) between TRM terminal and +S terminal.

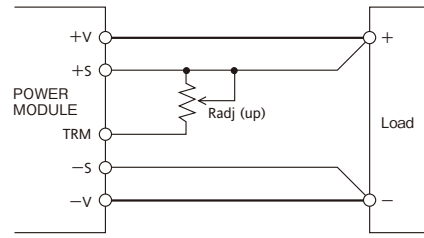

Fig.2-4 Connection for output voltage trim up

- (2-3) Equation of external resistor and output voltage

$$Radj(\text{up}) = \left(\frac{Vo(100\% + \Delta\%)}{1.225 \times \Delta\%} - \frac{100\% + 2 \times \Delta\%}{\Delta\%} \right) [k\Omega]$$

Vo: nominal output value of module
 Radj (up): external adjustment resistor
 Δ (%): Output voltage change rate against nominal output voltage

Below graph is relation Δ(%) and value of external resistor.

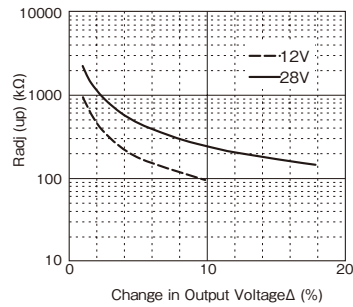

Fig.2-5 Δ (%) vs. Radj (up) (2)

3 Maximum Ripple and Noise

Measured value according to the specified methods based on JEITA-9141 (Clause 7.12 and clause 7.13) which is described in the following.

Connect according to fig.3-1 and measure. Connect capacitors (C2, C3: film capacitor or ceramic capacitor 0.022μF) between output terminals and the nearest M3 threaded hole. Connect capacitors (C4: refer to table 1-1 for electrolytic capacitor values, C5: ceramic capacitor 0.1μF) at 50mm distance from the output terminals. Measure at ceramic capacitor(C5) terminals as shown in fig. 3-1 using coaxial cable with JEITA attachment. Use oscilloscope with 100MHz frequency bandwidth or equivalent. Take note that output ripple voltage and output spike noise may vary depending on PCB wiring design. Generally, increasing capacitance value of external capacitor can reduce output ripple voltage and output spike noise.

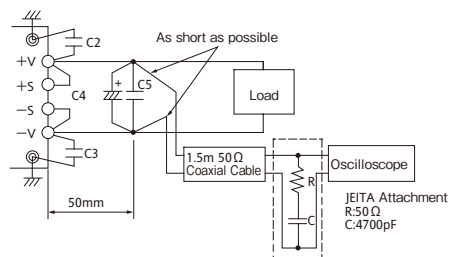

Fig.3-1 Measurement of Maximum Output Ripple & Noise

4 Maximum Line Regulation

Maximum value of output voltage change when input voltage is gradually varied (steady state) within specified input voltage range.

5 Maximum Load Regulation

Maximum value of output voltage change when output current is gradually varied (steady state) within specified output current range.

When using at dynamic load mode, audible noise could be heard from the power module and output voltage fluctuation might increase. A thorough pre-evaluation must be performed before using this power module.

6 Over Current Protection (OCP)

This power module has built-in OCP function.

Output will recover when short circuit or overload conditions are released. OCP setting value is fixed and therefore, cannot be externally adjusted.

Also, take note that power module might be damaged continuing output short circuit or over load conditions depending on thermal conditions.

7 Over Voltage Protection (OVP)

This power module has built-in OVP function.

OVP set point is relative to the rated output voltage value. OVP setting value is fixed and therefore, cannot be externally adjusted.

When OVP is triggered, output can be recovered by turning input line off and then turning it on again after lowering the input voltage below the voltage value indicated below, or by manual reset of the ON/OFF control terminal. Reset time for ON/OFF control terminal is 100ms or longer.

OVP release input voltage value : 24VDC and below

When verifying OVP function by applying external voltage at the output terminals, applied voltage value should not exceed specified OVP maximum value. Refer to specification table for OVP maximum value. Avoid applying external voltage that exceeds OVP maximum value because this will cause power module damage.

8 Over Temperature Protection (OTP)

This power module has built-in OTP function.

This function operates and shuts down the output when ambient temperature or internal temperature of power module abnormally rises. OTP operates at 105°C to 130°C baseplate temperature. OTP can be released when baseplate temperature drops down approximately to within 80°C to 95°C. However, take note that OTP will operate again unless the cause of abnormal heat of the power module is eliminated.

9 Remote Sensing (+S, -S terminal)

Remote sensing terminal is provided to compensate for voltage drop across the wirings from the power module output terminal to the load input terminal.

When remote sensing function is not used (local sensing), short +S terminal to +V terminal and, -S terminal to -V terminal.

Take note that voltage compensation range for line drop (voltage drop due to wiring) is determined such that output voltage at the output terminals is within output voltage range and that voltage between -V and -S terminals

is within 2V or less. Even for remote sensing case, use power module such that output power is within specified maximum output power.

Furthermore, reduce noise effect by using shield wire, twist pair, or parallel pattern.

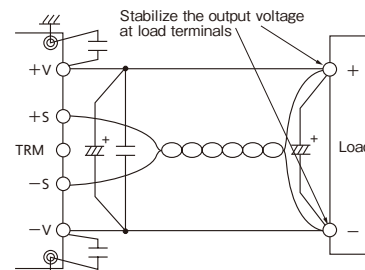

Fig.9-1 Remote Sensing is in Use

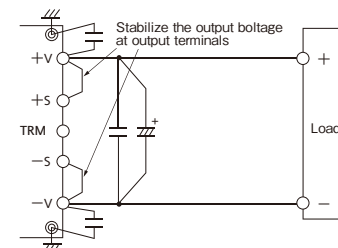

Fig.9-2 Remote Sensing is Not in Use

10 ON/OFF Control (CNT terminal)

Without turning the input supply on and off, the output can be enabled and disabled using this function. This function also can be used for output sequence of plural power modules.

There are two kinds of logic control, negative logic control and positive logic control, depend on the option selected. ON/OFF control circuit is on the primary side (the input side). For secondary control, isolation can be achieved through the use of an opto-coupler or relay.

	Logic	CNT Terminal Level to -Vin Terminal	Output status
Standard /Toption	Negative Logic	H Level ($4V \leq H \leq 35V$) or Open	OFF
		L Level ($0V \leq L \leq 0.8V$) or Short	ON
/Poption /PToption	Positive Logic	H Level ($4V \leq H \leq 35V$) or Open	ON
		L Level ($0V \leq L \leq 0.8V$) or Short	OFF

- Notes)
- When ON/OFF control function is not used for the Standard and /T option, CNT terminal should be shorted to -Vin terminal.
 - When ON/OFF control function is not used for the /P option and /PT option, CNT terminal should be opened.
 - When using long wiring, for prevention of noise, attach a 0.1μF capacitor between CNT terminal and -Vin terminal.
 - At L level, maximum source current from CNT terminal to -Vin terminal is 0.5mA
 - The maximum CNT terminal voltage is 35V.

(1) Output ON/OFF control

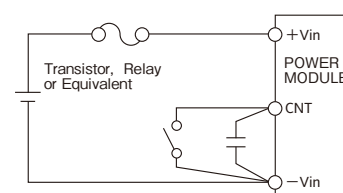

Fig.10-1 CNT Connection (1)

(2) Secondary (output side) control

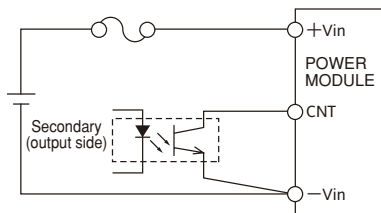

Fig.10-2 CNT Connection (2)

11 Parallel Operation

Parallel Operation can not be used.

12 Series Operation

Series operation is possible for PAH300, 350S48 series. Connections shown fig. 12-1 and fig. 12-2 are possible.

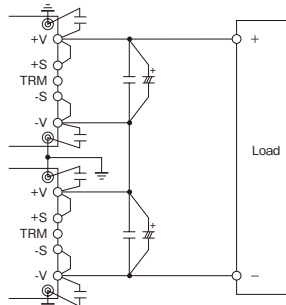

Fig.12-1 Series Operation due to High Output Voltage

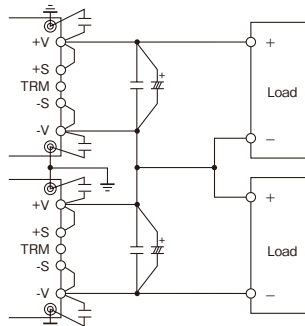

Fig.12-2 Series Operation due to \pm Output

13 Operating ambient temperature

There is no restriction on mounting direction but there should be enough consideration for airflow so that heat does not accumulate around the power module vicinity. Determine external components configuration and mounting direction on PCB such that air could flow through the heatsink at forced cooling and conventional cooling.

By maintaining actual baseplate temperature below 100°C, operation is possible.

For details on thermal design, refer to Application Notes "Thermal Design".

Note : Maximum baseplate temperature is 100°C. For worst case operating condition, verify baseplate temperature at measurement point indicated in fig. 13-1.

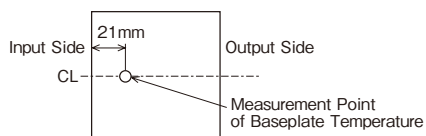

Fig.13-1 Measurement Point of Baseplate Temperature

For better improvement of power module reliability, de-rating of baseplate temperature when using is recommended.

14 Operating Ambient Humidity

Take note that moisture could lead to power module abnormal operation or damage.

15 Storage Ambient Temperature

Abrupt temperature change would cause moisture formation that leads to poor solderability of each terminal of the power module.

16 Storage Ambient Humidity

Take enough care when storing the power module because rust which causes poor solderability would form in each terminal when stored in high temperature, high humidity environment.

17 Cooling Method

Operating temperature range is specified by the baseplate temperature. Therefore, several methods of heat dissipation are possible.

For details on thermal design, refer to Application Notes "Thermal Design".

18 Baseplate Temperature vs. Output Voltage Drift

Output voltage drift is defined as the rate of voltage change when baseplate temperature only is changed during operation.

19 Withstand Voltage

This power module is designed to have a withstand voltage of 1.5kVDC between input and baseplate, 1.5kVDC between input and output and 500VDC between output and baseplate for 1 minute. When conducting withstand voltage test during incoming inspection, be sure to apply DC voltage. Also, set the current limit value of the withstand voltage testing equipment to 10mA.

Be sure to avoid conducting test with AC voltage because this would cause power module damage.

Furthermore, avoid throw in or shut off of the testing equipment when applying or when shutting down the test voltage. Instead, gradually increase or decrease the applied voltage. Take note especially not to use the timer of the test equipment because when the timer switches the applied voltage off, impulse voltage which has several times the magnitude of the applied voltage is generated causing damage to the power module.

Connect the terminals as shown in the diagram below.

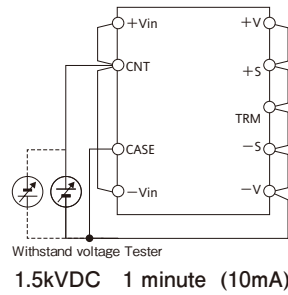

Fig.19-1 Withstand Voltage Test for Input-Output and Input - Baseplate

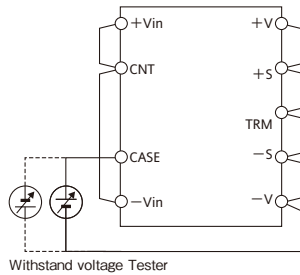

Fig.19-2 Withstand Voltage Test for Output-Baseplate

20 Isolation Resistance

Use DC isolation tester (MAX 500V) between output and baseplate. Isolation resistance value is 100MΩ and above

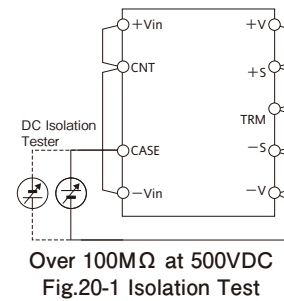

Fig.20-1 Isolation Test

21 Vibration

Vibration of power module is defined in case of mounting on printed circuit board.

22 Shock

Withstand shock value is defined to be the value at Den-sei -Lambda shipment and packaging conditions.

23 Others

Please refer to "Power Module Application Note" for thermal design and mounting direction.

PAH

3. Before concluding power module damage

Verify following items before concluding power module damage.

1) No output voltage

- Is specified input voltage applied?
- Are the ON/OFF control terminal (CNT), remote sensing terminal (+S, -S), output voltage trimming terminal (TRM) correctly connected?
- For cases where output voltage adjustment is used, is the resistor or variable resistor setting, connections correctly done?
- Are there no abnormalities in the output load used?
- Is the baseplate temperature within the specified temperature range?

2) Output voltage is high

- Are the remote sensing terminals (+S, -S) correctly connected?
- Is the measurement done at the sensing points?
- For cases where output voltage adjustment is used, is the resistor or volume setting, connections correctly done?

3) Output voltage is low

- Is specified input voltage applied?
- Are the remote sensing terminals (+S, -S) correctly connected?
- Is the measurement done at the sensing points?
- For cases where output voltage adjustment is used, is the resistor or variable resistor setting, connections correctly done?
- Are there no abnormalities in the output load used?





4) Load regulation and line regulation is large

- Is specified input voltage applied?
- Are the input terminals and the output terminals firmly connected?
- Is the measurement done at the sensing points?
- Is the input or output wire too thin?

5) Output ripple voltage is large

- Is the measuring method used the same or equivalent with the specified method in the Application Notes?
- Is the input ripple voltage value within the specified value?

PAH450S48 Instruction Manual

- PAH300S24, 350S24 Instruction Manual  B-175Page
- PAH50S48 ~ 200S48 Instruction Manual  B-182Page
- PAH300S48, 350S48 Instruction Manual  B-189Page
- PAH75D Instruction Manual  B-204Page
- PAH200H Instruction Manual  B-216Page

BEFORE USING THE POWER SUPPLY UNIT

Be sure to read this instruction manual thoroughly before using this product. Pay attention to all cautions and warnings before using this product. Incorrect usage could lead to an electrical shock, damage to the unit or a fire hazard.

WARNING

- Do not make unauthorized changes to power supply unit, otherwise you may have electric shock and void your warranty.
- Do not touch this unit and the internal components in operation or shortly after shut down. They may have high voltage or high temperature and as the unit dissipates its heat so the surface of the unit is hot. You may receive electric shock or burn.
- When the unit is operating, keep your hands and face away from it; you may be injured by an accident.
- Do not use unit under unusual condition such as emission of smoke or abnormal smell and sound etc. It might cause fire and electric shock. In such case, please contact us; do not repair by yourself, as it is dangerous for the user.
- Do not drop or insert anything into unit. It might cause failure and fire.
- Do not operate these units under condensation condition. It may cause fire and electric shock.

CAUTION

- As a component part, compliance with the standard will be based upon installation in the final application. This product must be installed in a restricted access location, accessible to authorized competent personnel only. These DC to DC converters have basic insulation between the input and the output. All models with an output 48V and above are considered to be non-SELV and must not be accessible to the operator. The installer must also provide protection against inadvertent contact by a service engineer.
- The input to this power supply must be isolated from the mains input by reinforced insulation.
- The equipment has been evaluated for use in a Pollution Degree 2 environment.
- This power supply is primarily designed and manufactured to be used and enclosed in other equipment.
- Confirm connections to input/output terminals and signal terminals are correct as indicated in the instruction manual.
- Attach a HBC external fuse to each module to ensure safety operation and compliance to each safety standard approval. The recommended input fuse rating within the instructions is as follows: 30A, 250V fast acting fuse. The breaking capacity and voltage rating of this fuse may be subject to the end use application.

- Input voltage, Output current, Output power, ambient temperature and ambient humidity should be used within specifications, otherwise the unit will be damaged.
- For application equipment, which requires very high reliability (Nuclear related equipment, traffic control equipment, medical equipment, etc.), please provide fail safety function in the equipment.
- Do not use the product in environment with strong electromagnetic field, corrosive gas and conductive substance.
- Do not operate and store this unit at an environment where condensation occurs. In such case, waterproof treatment is necessary.
- Never operate the unit under over current or shorted conditions for 30 seconds or more and out of Input Voltage Range as specification. Insulation failure, smoking, burning or other damage may occur to the unit.
- The output voltage of this power supply unit is considered to be a hazardous energy level (The voltage is 2V or more and the electric power is 240VA or more). Prevention from direct contact with output terminal is highly necessary. While installing or servicing this power supply unit, avoid dropping tools by mistake or direct contact with output terminal. This might cause an electrical shock. While repairing this power supply unit, the DC input power must be switched off and the input and output voltage should be safe level.
- To maintain the SELV output for outputs 28V and below, under fault conditions, the output must be connected to earth in the final application. However, during installation please ensure both the input positive and output positive are not grounded.
- The application circuits and their parameter are for reference only. Be sure to verify effectiveness of application circuits and their parameters before finalizing circuit design.
- Do not inject abnormal voltage to output terminal and signal terminal from the outside. The injection of reverse voltage or over voltage exceeding nominal output voltage to output terminals might cause damage to internal components.
- This information in this document is subject to change without prior notice. For actual design-in, please refer to the latest publications of data sheet, etc., for the most up-to date specifications of the unit.
- No part of this document may be copied or reproduced in any form without prior written consent of Densai-Lambda.

Note : CE MARKING

CE Marking when applied to a product covered by this handbook indicates compliance with the low voltage directive (2006/95/EC) in that it complies with EN60950.

1. Terminal Explanation

1 Terminal Arrangement

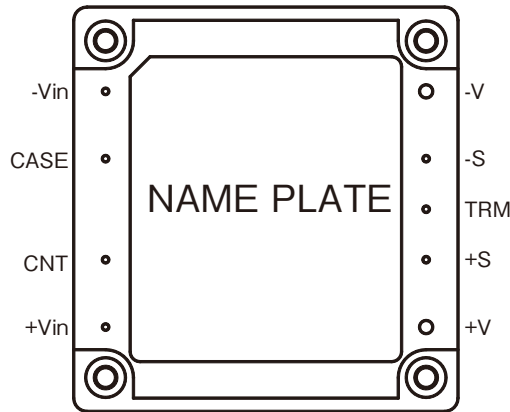

[Input Side Terminals]

- Vin : -Input Terminal
- CASE : Baseplate Terminal
- CNT : ON/OFF Control Terminal
- +Vin : +Input Terminal

[Output Side Terminals]

- V : -Output Terminal
- S : -Remote Sensing Terminal
- TRM : Output Voltage Trimming Terminal
- +S : +Remote Sensing Terminal
- +V : +Output Terminal

Baseplate can be connected to FG (frame ground) M3 threaded holes. (standard model)
Connect +Vin, -Vin, +V, -V with consideration of contacting resistance.



2. Explanations on Specifications

1 Input Voltage Range

Input voltage range for PAH450S48 Series is indicated below.

Input Voltage Range : 36 - 76VDC

Basically, ripple voltage (Vrpl) which results from rectification and filtering of commercial AC line is included within the input voltage as shown in Fig. 1-1. Ripple voltage must be limited within the voltage described below.

Allowable input ripple voltage : 4Vp-p

When this value is exceeded, the output ripple voltage becomes large.

Note that sudden input voltage change may cause variation of output voltage transitionally.

Also, input voltage waveform peak value must not exceed above input voltage range.

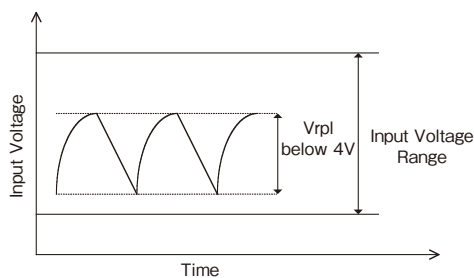

Fig.1-1 Input Ripple Voltage

Basic Connection

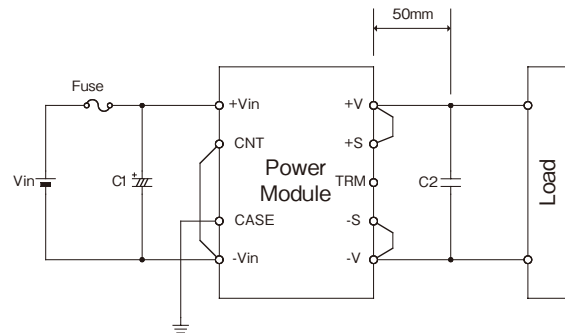

Fig.1-2 Basic Connection

Input Fuse

This power module has no built-in fuse. Use external fuse to acquire various Safety Standards and to improve safety. Also, use fast-blow type for every module.

Furthermore, fuse must be connected to the +Vin side if -Vin side is used as ground, or fuse must be connected to -Vin side if +Vin side is used as a ground.

Input Fuse recommended current rating:
PAH450S48 : 30A

C1 : 100μF

To prevent the effect of input line inductance to the power module, connect electrolytic capacitor or ceramic capacitor between +Vin and -Vin terminals.

Furthermore, use electrolytic capacitor with small ESR value. Especially take note that during line turn off at low ambient temperature, power module output will not normally shut down due to unstable C1 voltage.

Also, ripple current flows across this capacitor. Therefore, verify maximum allowable ripple current this capacitor when selecting component. Verify actual ripple current value by actual measurement.

**Recommended capacitor value : 100μF and above
(Voltage Rating 100V and above)**

- Notes
1. Use low impedance electrolytic capacitor with excellent temperature characteristics. (Nippon Chemi-con LXV Series or equivalent)
 2. When input line inductance becomes excessively high due to insertion of choke coil, operation of the power module could become unstable. For this case, increase C1 value more than the value indicated above.

PAH

C2 :

For stable operation, connect a ceramic capacitor between +V and -V within 50mm distance from the output terminals.

Take note that output ripple and output shutdown could be affected by ceramic capacitor, equivalent impedance and inductance characteristics of wiring.

Take note that output ripple voltage could vary according to PCB wiring design.

For cases of abrupt changes in load current or input voltage, increasing capacitance value of the external capacitors could reduce the voltage fluctuation.

Vout	C2
28V	50V 22 μF × 4parallel
48V	100V 4.7 μF × 6parallel

Table1-1 C4 Recommended Values of External Output Capacitor

Maximum capacitance (electrolytic capacitor) that can be connected between +V and -V, is shown below.

Maximum capacitance of output capacitor
 28V : 10,000μF
 48V : 2,000μF

- Notes
- Take note of the allowable ripple current of the capacitor to be used. Especially, when load adding capacitors for abrupt current changes, be sure to verify that ripple current does not exceed allowable ripple current before use.

C3 :

When switches or connectors are used between input source and PAH450S48 Series input terminals, impulse surge voltage is generated due to input throw-in by switch on/off or due to inserting/ removing of power module from the active line. For this case, connect an additional electrolytic capacitor C3 as shown in fig.1-3 and fig. 1-4.

**Recommended Capacitance Value : 100μF and above
(Voltage Rating 100V and above)**

Also, in-rush current flows at line throw-in. Therefore, be sure to verify capability of switch or fuse to withstand I2t at line throw-in.

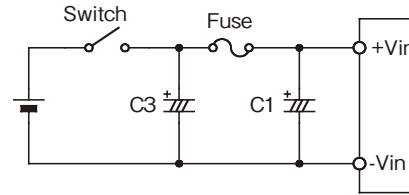

Fig.1-3 Input Filter with Input Switch

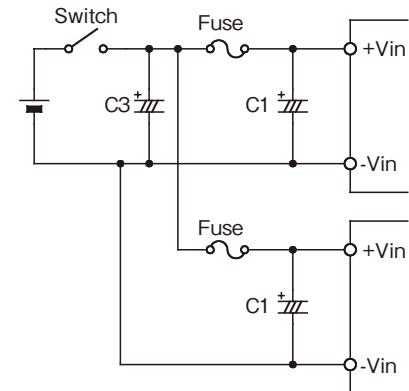

Fig.1-4 Input Filter when Plural Power Modules

Reverse input connection

Reverse input polarity would cause module damage. For cases where reverse connections are possible, connect a protective diode and fuse. Use protective diode with higher voltage rating than the input voltage, and with higher surge current rating than the fuse.

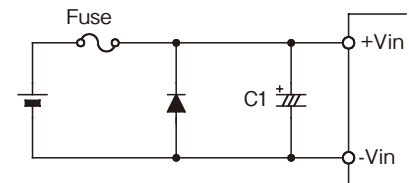

Fig.1-5 Protection for Reversed Connection of Input

Recommended application as EMI countermeasure (compliant to VCCI Class 1, FCC class A)

(1) Recommended application as EMI countermeasure

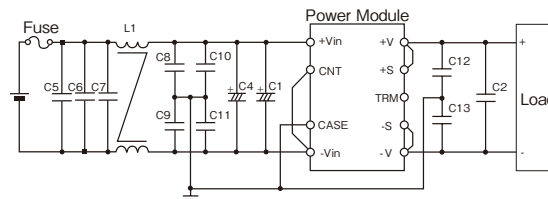

Fig.1-6 Recommended input filter as EMI countermeasure

Recommended Values:

- C1: 220μF (Electrolytic Capacitor)
- C2: Apply C2 capacitance in Basic Connection.
- C4: 220μF (Electrolytic Capacitor)
- C5-C7: 2.2μF (Ceramic Capacitor)
- C8,C9: 0.22μF (Film Capacitor)
- C10, C11: 4700pF (Film Capacitor)
- C12, C13: 0.47μF (Film Capacitor)
- L1 : 80μH (Common-mode choke coil)

- Notes
1. C4 (Electrolytic Capacitor) can be deleted if impedance of input line is lower and operation of power module is stable.
 2. C12 and C13 (Film Capacitor) can be deleted when output is connected to earth.
 3. VCCI Class 1, FCC Class A limits can be satisfied with the above recommended filter at Densai-Lambda measuring conditions. However, there are cases where above limits might not be satisfied due to input and output wiring method, as well as, peripheral circuits. When selecting input filter, be sure to verify actual EMI characteristics (CE and RE) before finalizing the filter. Refer to PAH450S48* Evaluation Data for details.

2 Output Voltage Adjustment Range

Output voltage could be adjusted within the range described below by external resistor or variable resistor. However, take note that OVP might trigger when output voltage adjustment exceeds the ranges indicated below.

- Output Voltage Adjustment Range**
- 28V: -40% - +18% of Nominal Output Voltage
 - 48V: -40% - +20% of Nominal Output Voltage

When increasing the output voltage, reduce the output current accordingly so as not to exceed the maximum output power.

Take note that input voltage range is limited as shown in fig.2-1 when output voltage is increased.

Remote sensing is possible even when output voltage is varied. For details on remote sensing function, please refer to "9.Remote Sensing"

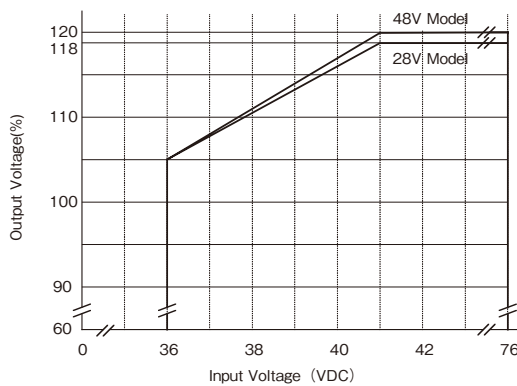

Fig.2-1 Limit of Input Voltage

● Output Voltage Adjustment by external resistor or by variable resistor

- (1) In case of adjusting output voltage lower
 - (1-1) Available maximum output current = rated output current

- (1-2) Connect an external resistor Radj(down) between the TRM terminal and -S terminal.

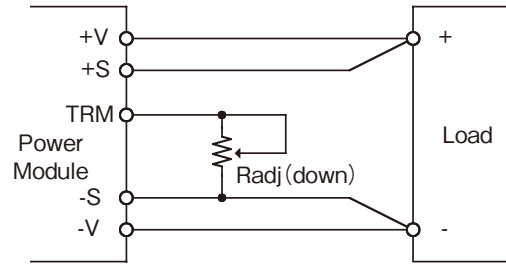

Fig.2-2 Connection for output voltage trim down

- (1-3) Equation of external resistor and output voltage

$$R_{adj(down)} = \left(\frac{100\%}{\Delta\%} - 2 \right) [k\Omega]$$

- Radj(down) : Value of external resistor
- Δ(%) : Output voltage change rate against nominal output voltage

Below graph is relation Δ(%) and value of external resistor.

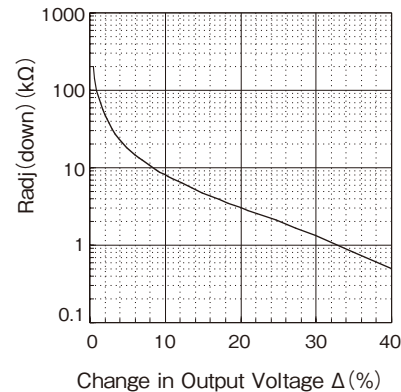

Fig.2-3 Δ(%) vs. Radj(down) (1)

- (2) In case of adjusting output voltage higher
 - (2-1) Allowable maximum output current = maximum output power ÷ output voltage (reduce maximum output current in specification.)

- (2-2) Connect an external resistor Radj(up) between TRM terminal and +S terminal.

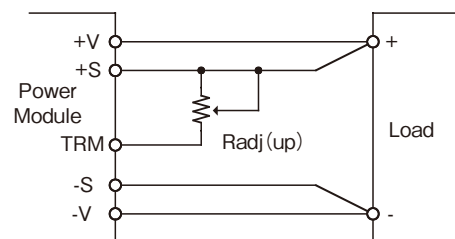

Fig.2-4 Connection for output voltage trim up



(2-3) Equation of external resistor and output voltage

$$\text{Radj(up)} = \left(\frac{V_o(100\% + \Delta\%) - 100\% + 2 \times \Delta\%}{1.225 \times \Delta\%} - \frac{100\% + 2 \times \Delta\%}{\Delta\%} \right) [\text{k}\Omega]$$

V_o : nominal output value of module

Radj(up) : external adjustment resistor

Δ (%) : Output voltage change rate against nominal output voltage

Below graph is relation Δ (%) and value of external resistor.

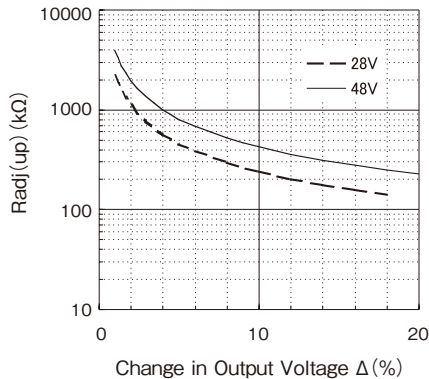

Fig.2-5 Δ (%) vs. Radj(up) (2)

PAH

3 Maximum Ripple and Noise

Measured value according to the specified methods based on JEITA-9141 (Clause 7.12 and clause 7.13) which is described in the following.

Connect according to fig.3-1 and measure. Connect capacitors (C2: refer to table 1-1 for ceramic capacitor values) at 50mm distance from the output terminals. Measure at ceramic capacitor (C2) terminals as shown in fig. 3-1 using coaxial cable with JEITA attachment. Use oscilloscope with 100MHz frequency bandwidth or equivalent. Take note that output ripple voltage and output spike noise may vary depending on PCB wiring design.

Generally, increasing capacitance value of external capacitor can reduce output ripple voltage and output spike noise.

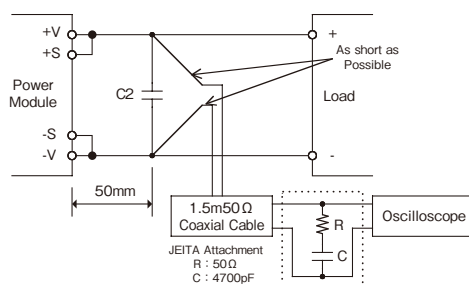

Fig.3-1 Measurement of Maximum Output Ripple & Noise

4 Maximum Line Regulation

Maximum value of output voltage change when input voltage is gradually varied (steady state) within specified input voltage range.

5 Maximum Load Regulation

Maximum value of output voltage change when output current is gradually varied (steady state) within specified output current range.

When using at dynamic load mode, audible noise could be heard from the power module and output voltage fluctuation might increase. A thorough pre-evaluation must be performed before using this power module.

6 Over Current Protection (OCP)

This power module has built-in OCP function.

Output will recover when short circuit or overload conditions are released. OCP setting value is fixed and therefore, cannot be externally adjusted.

Also, take note that power module might be damaged continuing output short circuit or over load conditions depending on thermal conditions.

7 Over Voltage Protection (OVP)

This power module has built-in OVP function.

OVP set point is relative to the rated output voltage value. OVP setting value is fixed and therefore, cannot be externally adjusted.

When OVP is triggered, output can be recovered by turning input line off and then turning it on again after lowering the input voltage below the voltage value indicated below, or by manual reset of the ON/OFF control terminal. Reset time for ON/OFF control terminal is 100ms or longer.

OVP release input voltage value : 10VDC and below

When verifying OVP function by applying external voltage at the output terminals, applied voltage value should not exceed specified OVP maximum value. Refer to specification table for OVP maximum value. Avoid applying external voltage that exceeds OVP maximum value because this will cause power module damage.

8 Over Temperature Protection (OTP)

This power module has built-in OTP function.

This function operates and shuts down the output when ambient temperature or internal temperature of power module abnormally rises. OTP operates at 105°C to 130°C baseplate temperature. OTP can be released when baseplate temperature drops down approximately to within 80°C to 95°C. However, take note that OTP will operate again unless the cause of abnormal heat of the power module is eliminated.

9 Remote Sensing (+S, -S terminal)

Remote sensing terminal is provided to compensate for voltage drop across the wirings from the power module output terminal to the load input terminal.

When remote sensing function is not used (local sensing), short +S terminal to +V terminal and, -S terminal to -V terminal. Take note that voltage compensation range for line drop (voltage drop due to wiring) is determined such that out-

put voltage at the output terminals is within output voltage range and that voltage between -V and -S terminals is within 2V or less. Even for remote sensing case, use power module such that output power is within specified maximum output power.

Furthermore, reduce noise effect by using shield wire, twist pair, or parallel pattern.

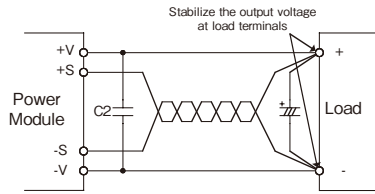

Fig.9-1 Remote Sensing is in Use

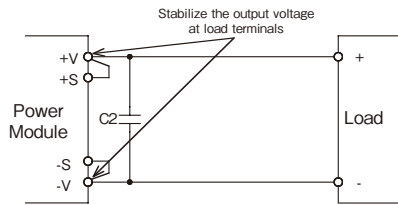

Fig.9-2 Remote Sensing is Not in Use

10 ON/OFF Control (CNT terminal)

Without turning the input supply on and off, the output can be enabled and disabled using this function. This function also can be used for output sequence of plural power modules. ON/OFF control circuit is on the primary side (the input side). For secondary control, isolation can be achieved through the use of an opto-coupler or relay.

- Notes
1. When ON/OFF control function is not used for the Standard and /T option, CNT terminal should be shorted to -Vin terminal.
 2. When using long wiring, for prevention of noise, attach a 0.1μF capacitor between CNT terminal and -Vin terminal.
 3. At L level, maximum source current from CNT terminal to -Vin terminal is 0.5mA.
 4. The maximum CNT terminal voltage is 35V.

(1) Output ON/OFF control

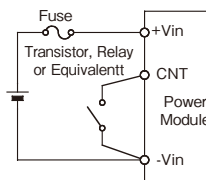

Fig.10-1 CNT Connection (1)

(2) Secondary (output side) control

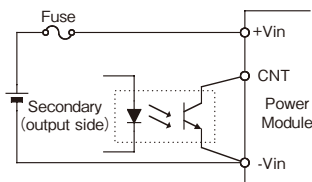

Fig.10-2 CNT Connection (2)

11 Parallel Operation

Parallel Operation can not be used.

12 Series Operation

Series operation is possible for PAH450S48 series. Connections shown fig. 12-1 and fig. 12-2 are possible.

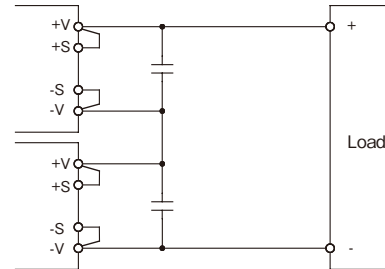

Fig.12-1 Series Operation due to High Output Voltage

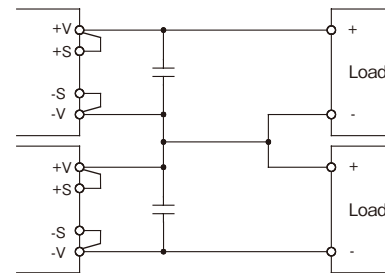

Fig.12-2 Series Operation due to ±Output

PAH

13 Operating ambient temperature

There is no restriction on mounting direction but there should be enough consideration for airflow so that heat does not accumulate around the power module vicinity. Determine external components configuration and mounting direction on PCB such that air could flow through the heatsink at forced cooling and conventional cooling. By maintaining actual baseplate temperature below 100°C, operation is possible.

For details on thermal design, refer to Application Notes "Thermal Design".

Note : Maximum baseplate temperature is 100°C. For worst case operating condition, verify baseplate temperature at measurement point indicated in fig. 13-1.

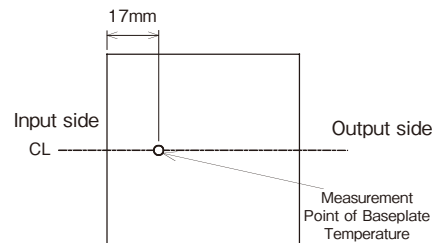

Fig.13-1 Measurement Point of Baseplate Temperature

For better improvement of power module reliability, derating of baseplate temperature when using is recommended.

14 Operating Ambient Humidity

Take note that moisture could lead to power module abnormal operation or damage.

15 Storage Ambient Temperature

Abrupt temperature change would cause moisture formation that leads to poor solderability of each terminal of the power module.

16 Storage Ambient Humidity

Take enough care when storing the power module because rust which causes poor solderability would form in each terminal when stored in high temperature, high humidity environment.

17 Cooling Method

Operating temperature range is specified by the baseplate temperature. Therefore, several methods of heat dissipation are possible.

For details on thermal design, refer to Application Notes "Thermal Design".

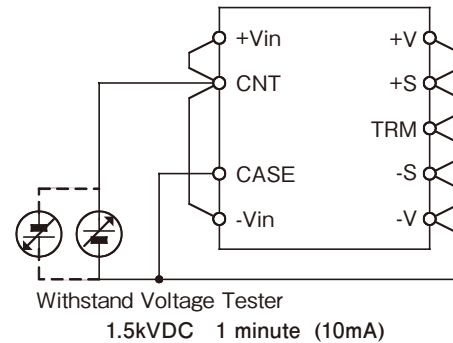

Fig.19-1 Withstand Voltage Test for Input-Output and Input - Baseplate

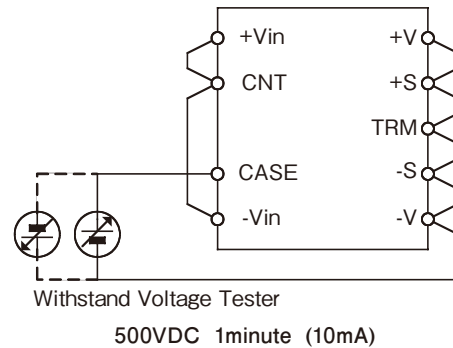

Fig.19-2 Withstand Voltage Test for Output-Baseplate

18 Baseplate Temperature vs. Output Voltage Drift

Output voltage drift is defined as the rate of voltage change when baseplate temperature only is changed during operation.

19 Withstand Voltage

This power module is designed to have a withstand voltage of 1.5kVDC between input and baseplate, 1.5kVDC between input and output and 500VDC between output and baseplate for 1 minute. When conducting withstand voltage test during incoming inspection, be sure to apply DC voltage. Also, set the current limit value of the withstand voltage testing equipment to 10mA.

Be sure to avoid conducting test with AC voltage because this would cause power module damage.

Furthermore, avoid throw in or shut off of the testing equipment when applying or when shutting down the test voltage. Instead, gradually increase or decrease the applied voltage. Take note especially not to use the timer of the test equipment because when the timer switches the applied voltage off, impulse voltage which has several times the magnitude of the applied voltage is generated causing damage to the power module.

Connect the terminals as shown in the diagram below.

20 Isolation Resistance

Use DC isolation tester (MAX 500V) between output and baseplate. Isolation resistance value is 100MΩ and above at 500VDC applied voltage. Also take note that depending on the isolation tester used, some testers generate high voltage pulse. Discharge the power module after test using a resistor, etc.

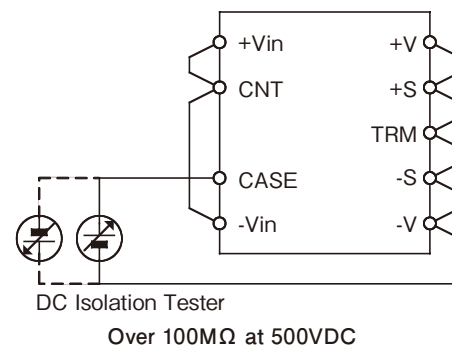

Fig.20-1 Isolation Test

21 Vibration

Vibration of power module is defined in case of mounting on printed circuit board.

22 Shock

Withstand shock value is defined to be the value at Den-sei -Lambda shipment and packaging conditions.

23 Others

Please refer to "Power Module Application Note" for thermal design and mounting direction.





3. Before concluding power module damage

Verify following items before concluding power module damage.

- 1) No output voltage
 - Is specified input voltage applied?
 - Are the ON/OFF control terminal (CNT), remote sensing terminal (+S, -S), output voltage trimming terminal (TRM) correctly connected?
 - For cases where output voltage adjustment is used, is the resistor or variable resistor setting, connections correctly done?
 - Are there no abnormalities in the output load used?
 - Is the baseplate temperature within the specified temperature range?
- 2) Output voltage is high
 - Are the remote sensing terminals (+S, -S) correctly connected?
 - Is the measurement done at the sensing points?
 - For cases where output voltage adjustment is used, is the resistor or volume setting, connections correctly done?
- 3) Output voltage is low
 - Is specified input voltage applied?
 - Are the remote sensing terminals (+S, -S) correctly connected?
 - Is the measurement done at the sensing points?
 - For cases where output voltage adjustment is used, is the resistor or variable resistor setting, connections correctly done?
 - Are there no abnormalities in the output load used?
- 4) Load regulation and line regulation is large
 - Is specified input voltage applied?
 - Are the input terminals and the output terminals firmly connected?
 - Is the measurement done at the sensing points?
 - Is the input or output wire too thin?
- 5) Output ripple voltage is large
 - Is the measuring method used the same or equivalent with the specified method in the Application Notes?
 - Is the input ripple voltage value within the specified value?

PAH

PAH75D24 SERIES Instruction Manual

- PAH300S24, 350S24 Instruction Manual  B-175Page
- PAH50S48 ~ 200S48 Instruction Manual  B-182Page
- PAH300S48, 350S48 Instruction Manual  B-189Page
- PAH450S48 Instruction Manual  B-196Page
- PAH200H Instruction Manual  B-216Page

Before Using This Power Module

Pay attention to all warnings and cautions before using this unit. Incorrect usage could lead to an electric shock, damage to the unit, or a fire hazard. Be sure to read below warnings and cautions before using the power module.

Warning

- Do not touch heatsink and case which may be hot.
- Do not open the case and touch the internal components. They may have high temperature or high voltage which may get you in electric shock or burned.
- When the unit is operating, keep your hands and face away from the unit. You may get injured by accident.

Caution

- Confirm connections to input/output terminals and signal terminals are correct as indicated in the instruction manual.
- Attach a fast blow type external fuse to each module to ensure safety operation and to acquire each safety standard approval.
- This power module is designed for professional installation within an end user equipment.
- The input supply, 18 - 36VDC must be isolated from the mains

primary power supply by reinforced insulation in accordance with EN60950/UL1950.

- Equipment with these products mounted inside must be protected to prevent contact with by technical service staff or dropped tools, etc.
- When repairing the equipment, please be sure to turn off input source, and confirm that input and output voltage has dropped down to a safe level.
- The application circuits and their parameter are for reference only. Be sure to verify effectiveness of application circuits and their parameters before finalizing circuit design.
- The information in this document is subject to change without notice. For actual design-in, please refer to the latest publications of data sheet, etc., for the most up-to-date specifications of the unit.
- No part of this document may be copied or reproduced in any form or by any mean without prior written consent of Densel-Lambda.
- Do not inject abnormal voltage to output or signal pins. Especially, when inject negative voltage or voltage exceeding rated output voltage to output pins might cause damage to internal output capacitor (Functional Polymerized Capacitor).

PAH

1. Terminal Pin Configurations

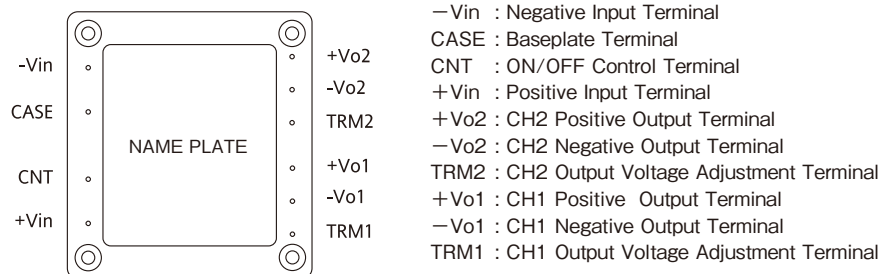

2. Explanation on Specifications

1 Basic Connection

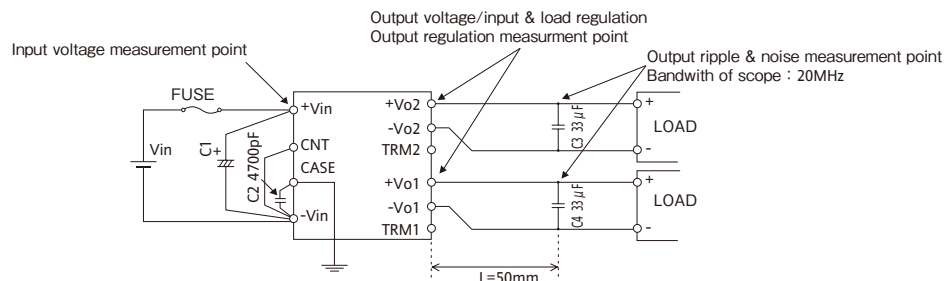

Note: This diagram is for Negative Logic "ON/OFF" Option.

2 External Components

The table below shows the recommended values for the above external components.

Item	Vo1	Vo2
F1	250V 10A (UL approved and fast acting)	
C1	For Tbp = -20°C to 100°C Select the E-cap with low ESR and sufficient allowable ripple current, verify actual ripple current value by actual measurement. Recommended Nichicon UPW series, Capacitance value: 100µF and above. Voltage rating: 50V and above. For Tbp = -40°C to 100°C Recommended ceramic cap.: 50V 33µF	
C2	Ceramic capacitor : 2kVAC 4700pF	
C3, C4	Ceramic capacitor : 33µF	

PAH75D24 SERIES module is not internally fused. To ensure safe operation and to receive each safety standard approval, please connect an external fuse, F1 as shown in the diagram above.

Input capacitor C1 is recommended to stabilize the module when the module is powered from a high impedance source. Capacitor C2 is used to absorb noise coming from the module itself. This capacitor will also help the EMI performance of the module.

The function of capacitor C3 and C4 is to reduce the output ripple of the power module and high frequency noise that is produced by the module.

If in any application that an input reversal connection is possible, a protective diode which is connected across +Vin and -Vin is recommended.

3 Input Voltage Range

The operating input voltage range of PAH75D24 SERIES is 18 - 36VDC. The maximum allowable input ripple voltage (Vrpl) is 4V. Any ripple that exceeds this value might cause the module to become unstable.

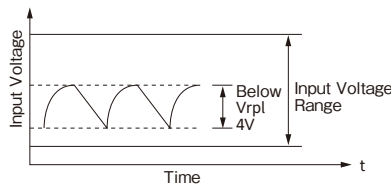

4 Output Voltage Adjust Range

The output voltage of power module can be adjusted by connecting an external resistor (R_{adj}) between the TRIM pin and either the +Vo or -Vo pins.

With an external resistor (R_{adj}) between TRIM pin and +Vo pin as shown in diagram below, output voltage will decrease.

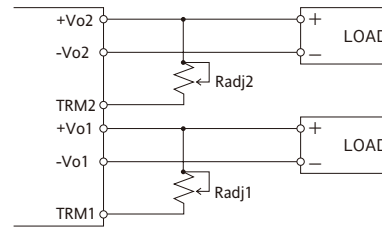

If the external resistor (R_{adj}) is connected between the TRIM pin and -Vo pin, the output voltage will increase. Diagram shown below is the output voltage trim up connection.

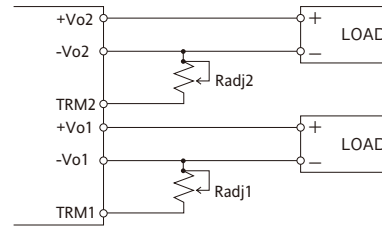

The equations and graphs for the required external resistor (R_{adj}) value to obtain a percentage output voltage change of ΔVo% is as shown in the next page.

For output adjust down, the allowable output current have to be the same as nominal output current.

For output adjust up, the allowable output current have to derate to maximum power.

Refer to the below table

	Vo1(V)	Io1(A)	Vo2(V)	Io2(A)	Po(W)
Output adjust up	5.5	4.64	3.3	15	75
	5	4.11	3.63	15	75
Nominal output	5	5.1	3.3	15	75
Output adjust down	4.5	5.1	3.3	15	72.45
	5	5.1	2.97	15	70.05



1) PAH75D24-5033 - Output Adjustment

Followings show the equations and graphs for the required external resistor to tune down and up output voltage for PAH75D24-3325 model.

i) Vo1 (5V) : output adjust down

$$R_{adj1}(\text{down}) = \left(\frac{2.5 - \Delta Vo(4.32)}{\Delta Vo} \right) k\Omega$$

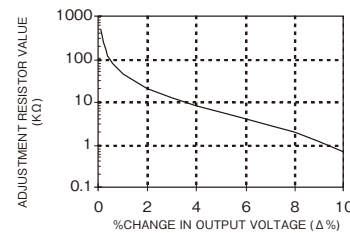

ii) Vo2 (3.3V): output adjust down

$$R_{adj2} \text{ (down)} = \left(\frac{0.256 - \Delta Vo(0.685)}{\Delta Vo} \right) k\Omega$$

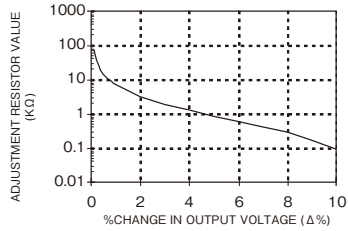

iii) Vo1 (3.3V): output adjust up

$$R_{adj1} \text{ (up)} = \left(\frac{2.0599 - \Delta Vo(5.11)}{\Delta Vo} \right) k\Omega$$

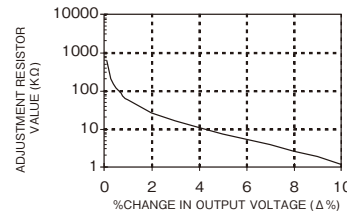

iii) Vo1 (5V): output adjust up

$$R_{adj1} \text{ (up)} = \left(\frac{2.5 - \Delta Vo(3.32)}{\Delta Vo} \right) k\Omega$$

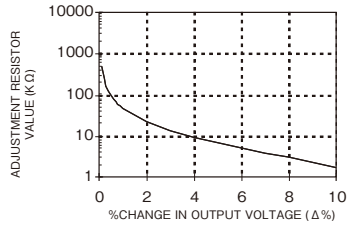

iv) Vo2 (2.5V): output adjust up

$$R_{adj2} \text{ (up)} = \left(\frac{6.1757 - \Delta Vo(10)}{\Delta Vo} \right) k\Omega$$

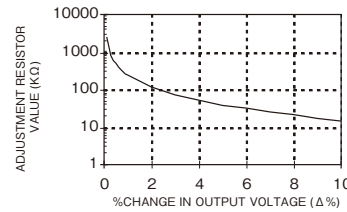

iv) Vo2 (3.3V): output adjust up

$$R_{adj2} \text{ (up)} = \left(\frac{0.8 - \Delta Vo(0.365)}{\Delta Vo} \right) k\Omega$$

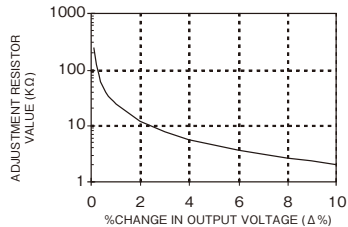

2) PAH75D24-3325 – output adjustment

Followings show the equations and graphs for the required external resistor to tune down and up output voltage for PAH75D24-3325 model.

i) Vo1 (3.3V): output adjust down

$$R_{adj1} \text{ (down)} = \left(\frac{3.4222 - \Delta Vo(6.7712)}{\Delta Vo} \right) k\Omega$$

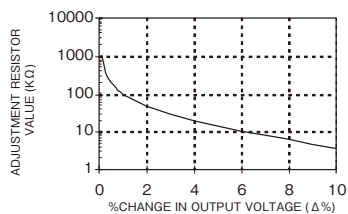

ii) Vo2 (2.5V): output adjust down

$$R_{adj2} \text{ (down)} = \left(\frac{6.1511 - \Delta Vo(14.9307)}{\Delta Vo} \right) k\Omega$$

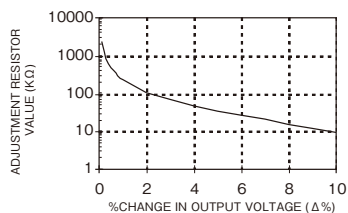

5 Output Ripple & Noise Measurement Method

The standard measurement for output ripple and noise are based on normal probe with 20MHz bandwidth scope. Upon measurement of the ripple voltage, make sure that the oscilloscope probe leads are not too long.

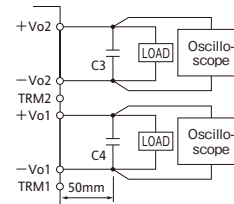

Specification

The ripple & noise specification for operating range between -40°C to 100°C is shown below.

i) 5.0V & 3.3V

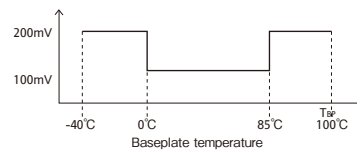

ii) 2.5V & 1.8V

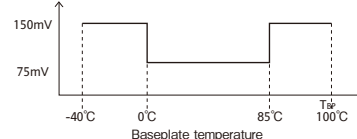

iii) JEITA measurement method

Below results are for reference only which is based on JEITA standard (JEITA probe with 100MHz bandwidth scope). The measurement condition is Vin=24V and Tbp=25°C.

PAH75D24-5033

Load Condition	Vo1 (5V)	Vo2 (3.3V)
Io1=15A ; Io2=0A	30mV	42mV
Io1=0A ; Io2=15A	31mV	43mV
Io1=5A ; Io2=15A	32mV	45mV

PAH75D24-3325

Load Condition	Vo1 (3.3V)	Vo2 (2.5V)
Io1=15A ; Io2=0A	20mV	18mV
Io1=0A ; Io2=15A	22mV	19mV
Io1=5A ; Io2=15A	23mV	21mV

6 Maximum Line Regulation

Maximum line regulation is the maximum output voltage change when the input voltage is slowly varied within the input voltage range. The measurement point for the input and output voltages are $\pm V_{in}$, $\pm V_{o1}$ and $\pm V_{o2}$ respectively.

7 Maximum load regulation

Maximum load regulation is the maximum output voltage value change when varying the load current slowly within the standard output current range. The measurement point for the input and output voltages are $\pm V_{in}$, $\pm V_{o1}$ and $\pm V_{o2}$ respectively.

8 Brownout

There will be output voltage overshoot during brown-out (momentary input line off) condition.

9 Over Current Protection

The PAH75D24 SERIES is equipped with an over current protection circuit. When the short or overload condition is removed, the output will automatically recover. This setting is fixed and cannot be varied externally. If the short or overload condition continues, the power module could be damaged due to the heat condition.

10 Over Voltage Protection

There are 2 types of over voltage protection method available for PAH75D24 SERIES. In the standard model, a latching shutdown method is adopted. For this method there are two ways to reset the power module after OVP protection triggers. They are by (i) giving a pulse to the control pin or (ii) recycling the input voltage. In the /V optional model, the power module will shutdown after OVP protection triggers but will recover automatically when over voltage is removed.

11 Thermal Protection

The PAH75D24 SERIES have a thermal protection circuit that senses the baseplate temperature between the range of 105°C to 130°C for an over temperature condition.

Under a condition where the ambient temperature or the power module internal temperature rises excessively, the thermal protection circuit will shut down the power module. The power module will recover automatically when the baseplate temperature cools down.

12 ON/OFF Control (CNT)

Without turning the input on and off, the output can be enabled and disabled using this function. This control circuit is on the input side of the power module; CNT terminal pin. There are two options available in this function, which are Negative Logic and Positive Logic. In the standard model where Negative Logic is used, power module will turn on when the CNT terminal pin is shorted to $-V_{in}$ or a low logic voltage is provided. The Power module will turn off when CNT terminal pin is open or Logic high is provided. In the /P optional model where Positive Logic is used, the control method is vice versa to Negative logic.

The maximum CNT pin voltage when it is opened is 7V. The maximum low logic sourcing current is 0.6mA. When using this function, attach a 0.1uF capacitor between the CNT and $-V_{in}$ terminals as close as possible.

Remote ON/OFF control can also be exercised by opening or closing the contacts of a switch or relay, or by operating a transistor as a switch in series with the CNT terminal.

Standard remote ON/OFF control circuit is provided in the primary circuit. For secondary control, isolation can be achieved through use of an optocoupler or relay.

CNT Connection Method

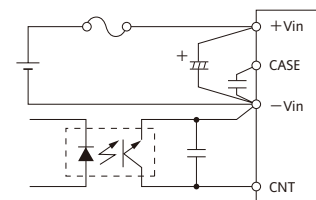

Below tables summarize the CNT levels and output states with different logic types.

a) Negative Logic: (Standard model)

CNT Level for INPUT -V	OUTPUT
H (more than 2.0V) or Open	OFF
L (less than 1.0V) or Short	ON

b) Positive Logic: (/P option)

CNT Level for INPUT -V	OUTPUT
H (more than 2.0V) or Open	ON
L (less than 1.0V) or Short	OFF

13 Operation Temperature

The baseplate temperature range for PAH75D24 SERIES is from -40°C to 100°C.

14 Operation Humidity

Avoid the buildup of condensation on or in the power module.

PAH

15 Storage Temperature

Please note that sudden temperature changes can cause condensation buildup, and other harmful affects to each terminal solder.

16 Storage Humidity

High temperature and humidity can cause the terminals on the module to oxidize. The quality of the solder will become worse.

17 Cooling Method

The operating temperature is specified by the baseplate temperature. Various cooling methods are possible such as using heatsink or chassis of the equipment. If the temperature is very high, fan is recommended.

18 Baseplate Temperature vs. Output Regulation

This is the output voltage change ratio when varying the baseplate operation temperature.

PAH

19 Withstand Voltage

The power module is designed to withstand 1.5kVDC between the input to the baseplate and input to output for 1 minute. In the case that the withstand voltage is tested in the incoming goods test, etc., please set the limit of the test equipment to 20 mA. The applied voltage must be increased gradually from zero to the testing value, and then decreased gradually at shutdown. Do not use a timer where a pulse of several times the applied voltage can be generated. This could cause damage to the module. Be sure to short all the input and output pins as shown below.

(Input ~ Baseplate)

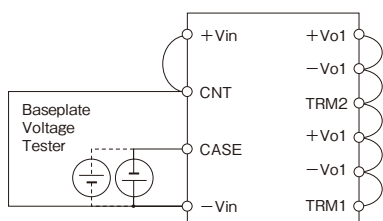

1.5kVDC 1 min. (20mA)

Note: Please be sure to short all the input & output pins as shown above.

(Input ~ Output)

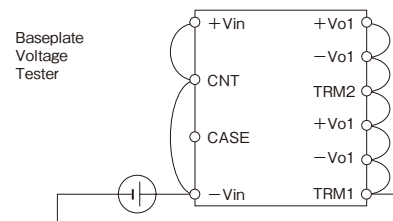

1.5kVDC

1 min. (20mA)

Note: Please be sure CASE is not shorted to any pins.

20 Isolation Resistance

The isolation resistance is more than 100MΩ at 500VDC when tested with a DC isolation tester between the output and the baseplate. Make sure that during testing, the isolation testers does not produce a high pulse when the applied voltage is varied. Ensure that the tester is fully discharged after the test.

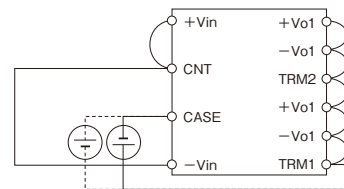

21 Vibration

Please refer to the power module mounting in the PAH75D24 SERIES Handbook in order to achieve vibration level stated in the specification.

22 Shock

Value for the conditions of our shipping and packaging.





23 Others

The performance of a system with Power Module is influenced according to various conditions -- PCBs, chassis, mechanics, heat dissipation.

Please evaluate actual products, and confirm its performance.

Please refer to "Power Module Application Note" for thermal design and mounting direction.

PAH75D48 SERIES Instruction Manual

- PAH300S24, 350S24 Instruction Manual  B-176Page
- PAH50S48 ~ 200S48 Instruction Manual  B-182Page
- PAH300S48, 350S48 Instruction Manual  B-189Page
- PAH450S48 Instruction Manual  B-196Page
- PAH200H Instruction Manual  B-216Page

Before Using This Power Module

Pay attention to all warnings and cautions before using this unit. Incorrect usage could lead to an electric shock, damage to the unit, or a fire hazard. Be sure to read below warnings and cautions before using the power module.

Warning

- Do not touch heatsink and case which may be hot.
- Do not open the case and touch the internal components. They may have high temperature or high voltage which may get you in electric shock or burned.
- When the unit is operating, keep your hands and face away from the unit. You may get injured by an accidents.

Caution

- Confirm connections to input/output terminals and signal terminals are correct as indicated in the instruction manual.
- Attach a fast blow type external fuse to each module to ensure safety operation and to acquire each safety standard approval.
- This power module is designed for professional installation within an end user equipment.
- The input supply, 36 - 76VDC must be isolated from the

mains primary power supply by reinforced insulation in accordance with EN60950/UL1950.

- Equipment with these products mounted inside must be protected to prevent contact with by technical service staff or dropped tools, etc.
- When repairing the equipment, please be sure to turn off input source, and confirm that input and output voltage has dropped down to a safe level.
- The application circuits and their parameter are for reference only. Be sure to verify effectiveness of application circuits and their parameters before finalizing circuit design.
- The information in this document is subject to change without notice. For actual design-in, please refer to the latest publications of data sheet, etc., for the most up-to-date specifications of the unit.
- No part of this document may be copied or reproduced in any form or by any mean without prior written consent of Densel-Lambda.
- Do not inject abnormal voltage to output or signal pins. Especially, when inject negative voltage or voltage exceeding rated output voltage to output pins might cause damage to internal output capacitor (Functional Polymerized Capacitor).

PAH

1. Terminal Pin Configurations

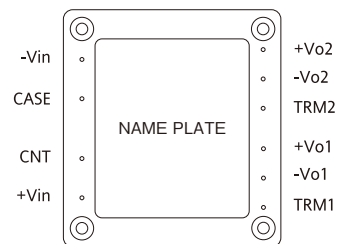

- Vin : Negative Input Terminal
- CASE : Baseplate Terminal
- CNT : ON/OFF Control Terminal
- +Vin : Positive Input Terminal
- +Vo2 : CH2 Positive Output Terminal
- Vo2 : CH2 Negative Output Terminal
- TRM2 : CH2 Output Voltage Adjustment Terminal
- +Vo1 : CH1 Positive Output Terminal
- Vo1 : CH1 Negative Output Terminal
- TRM1 : CH1 Output Voltage Adjustment Terminal

2. Functions on Specifications

1 BASIC CONNECTION

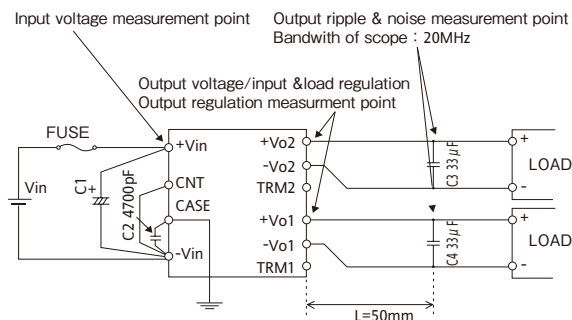

Note: This diagram is for Negative Logic "ON/OFF" Option.

2 External Components

The table below shows the recommended values for the above external components.

Item	Vo1	Vo2
F1	250V 5A (UL approved and fast acting)	
C1	Tbp = -20°C to 100°C: 100V 33uF E-cap. (Use low ESR type E-cap such as KME series of Nippon Chemi-con) Tbp = -40°C to 100°C : 100V 33uF Ceramic cap.	
C2	Ceramic capacitor: 2kVAC 4700pF	
C3, C4	Ceramic capacitor: 33uF	

PAH75D48 SERIES module is not internally fused. To ensure safe operation and to receive each safety standard approval, please connect an external fuse F1 as shown in the diagram above.

Input capacitor C1 is recommended to stabilize the module when the module is powered from a high impedance source. Capacitor C2 is used to absorb noise coming from the module itself. This capacitor will also help the EMI performance of the module.

The function of capacitor C3 is to reduce the output ripple of the power module and high frequency noise that is produced by the module.

If in any application that an input reversal connection is possible, a protective diode which is connected across +Vin and -Vin is recommended.

3 Input Voltage Range

The operating input voltage range of PAH75D48 SERIES is 36 - 76VDC. The maximum allowable input ripple voltage (Vrpl) is 4V. Any ripple that exceeds this value might cause the module to become unstable.

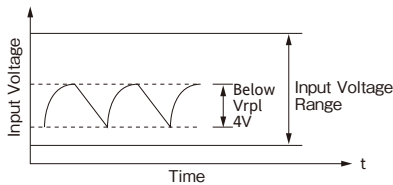

4 Output Voltage Adjust Range

The output voltage of power module can be adjusted by connecting an external resistor (R_{adj}) between the TRIM pin and either the +Vo or -Vo pins. There are two options available for the trim function for models 5033 & 3325, which are standard & /Z option.

With an external resistor (R_{adj}) between TRIM pin and +Vo pin, output voltage will decrease as shown in diagram below.

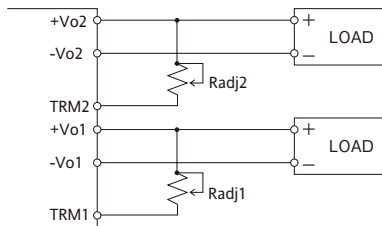

If the external resistor (R_{adj}) is connected between the TRIM pin and -Vo pin, the output voltage will increase. Diagram shown below is the output voltage trim up connection.

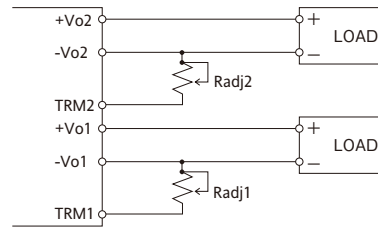

The equations and graphs for the required external resistor (R_{adj}) value to obtain a percentage output voltage change of ΔVo% is as shown in the next page.

For output adjust down, the allowable output current have to be the same as nominal output current.

For output adjust up, the allowable output current have to derate to maximum power.

Refer to the below table

	Vo1(V)	Io1(A)	Vo2(V)	Io2(A)	Po(W)
Output adjust up	5.5	4.64	3.3	15	75
	5	4.11	3.63	15	75
Nominal output	5	5.1	3.3	15	75
Output adjust down	4.5	5.1	3.3	15	72.45
	5	5.1	2.97	15	70.05

1) PAH75D48-5033 – Output Adjustment

Followings show the equations and graphs for the required external resistor to tune down and up output voltage for PAH75D48-5033 standard model.

i) Vo1 (5V): output adjust down

$$R_{adj1}(\text{down}) = \left(\frac{2.5 - \Delta Vo (4.32)}{\Delta Vo} \right) \text{ k}\Omega$$

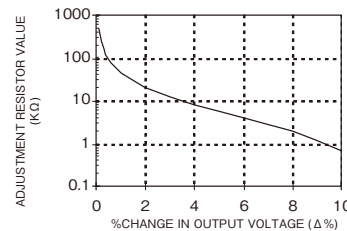

ii) Vo2 (3.3V): output adjust down

$$R_{adj2}(\text{down}) = \left(\frac{0.256 - \Delta Vo (0.685)}{\Delta Vo} \right) \text{ k}\Omega$$

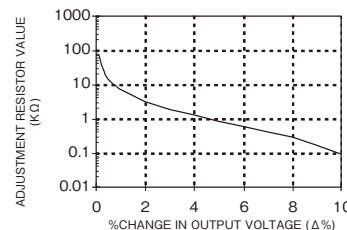

iii) Vo1 (5V): output adjust up

$$R_{adj1}(up) = \left(\frac{2.5 - \Delta Vo(3.32)}{\Delta Vo} \right) k\Omega$$

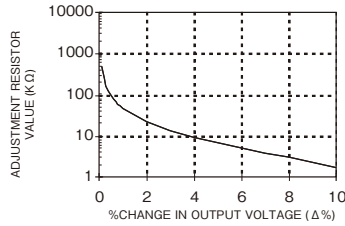

iv) Vo2 (3.3V): output adjust up

$$R_{adj2}(up) = \left(\frac{0.8 - \Delta Vo(0.365)}{\Delta Vo} \right) k\Omega$$

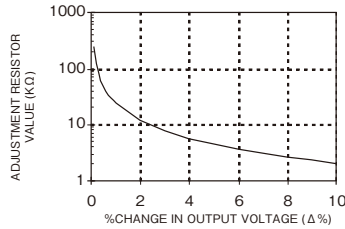

2) PAH75D48-5033/Z - Output Adjustment (/Z Option)

Followings show the equations and graphs for the required external resistor to tune down and up output voltage for PAH75D48-5033/Z optional model.

i) Vo1 (5V): output adjust down

$$R_{adj1}(down) = \left(\frac{2.5 - \Delta Vo(4.32)}{\Delta Vo} \right) k\Omega$$

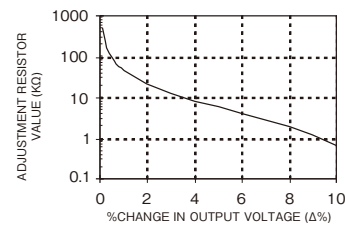

ii) Vo2 (3.3V): output adjust down

$$R_{adj2}(down) = \left(\frac{0.256 - \Delta Vo(0.685)}{\Delta Vo} \right) k\Omega$$

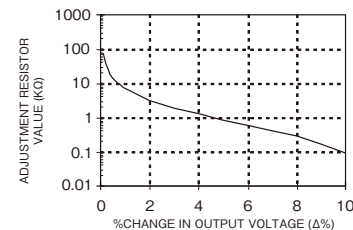

iii) Vo1 (5V): output adjust up

$$R_{adj1}(up) = \left(\frac{2.5 - \Delta Vo(3.32)}{\Delta Vo} \right) k\Omega$$

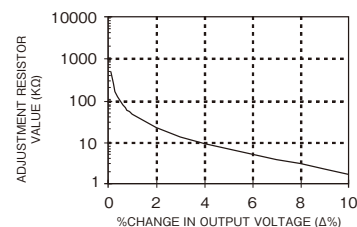

iv) Vo2 (3.3V): output adjust up

$$R_{adj2}(up) = \left(\frac{0.8 - \Delta Vo(0.365)}{\Delta Vo} \right) k\Omega$$

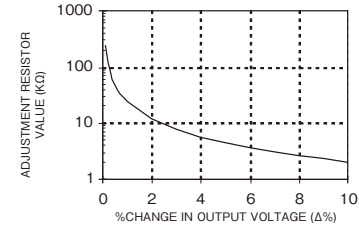

3) PAH75D48-3325 - output adjustment (Standard)

Followings show the equations and graphs for the required external resistor to tune down and up output voltage for PAH75D48-3325 standard model.

i) Vo1 (3.3V): output adjust down

$$R_{adj1}(down) = \left(\frac{3.4814 - \Delta Vo(2.69)}{\Delta Vo} \right) k\Omega$$

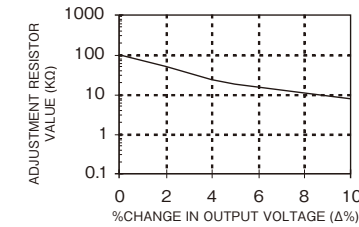

ii) Vo2 (2.5V): output adjust down

$$R_{adj2}(down) = \left(\frac{0.51 - \Delta Vo(1.53)}{\Delta Vo} \right) k\Omega$$

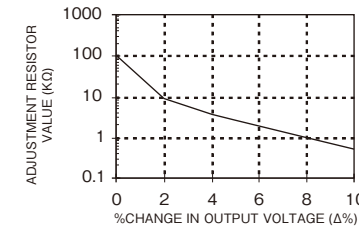

iii) Vo1 (3.3V): output adjust up

$$R_{adj1}(up) = \left(\frac{2.0956 - \Delta Vo}{\Delta Vo} \right) k\Omega$$

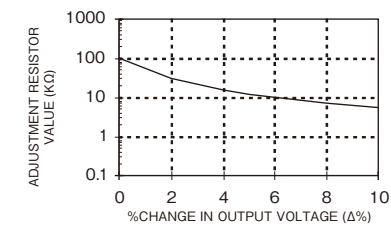

iv) Vo2 (2.5V): output adjust up

$$R_{adj2}(up) = \left(\frac{2.04 - 0.510 \Delta Vo}{\Delta Vo} \right) k\Omega$$

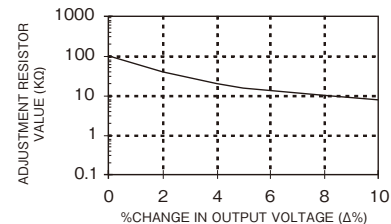

PAH

4) PAH75D48-3325/Z – Output Adjustment (/Z Option)

Followings show the equations and graphs for the required external resistor to tune down and up output voltage for PAH75D48-3325/Z optional model.

i) Vo1 (3.3V): output adjust down

$$R_{adj1}(\text{down}) = \left(\frac{3.4222 - \Delta Vo(6.7712)}{\Delta Vo} \right) k\Omega$$

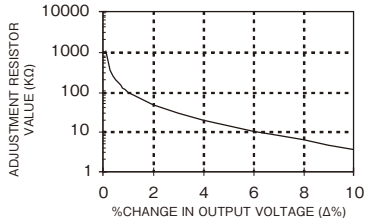

ii) Vo2 (2.5V): output adjust down

$$R_{adj2}(\text{down}) = \left(\frac{6.1511 - \Delta Vo(14.9307)}{\Delta Vo} \right) k\Omega$$

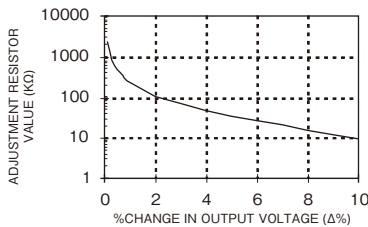

iii) Vo1 (3.3V): output adjust up

$$R_{adj1}(\text{up}) = \left(\frac{2.0599 - \Delta Vo(5.11)}{\Delta Vo} \right) k\Omega$$

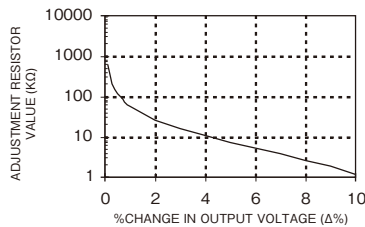

iv) Vo2 (2.5V): output adjust up

$$R_{adj2}(\text{up}) = \left(\frac{6.1757 - \Delta Vo(10)}{\Delta Vo} \right) k\Omega$$

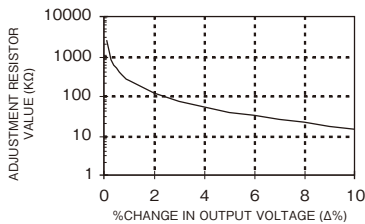

5) PAH75D48-3318 – output adjustment

Followings show the equations and graphs for the required external resistor to tune down and up output voltage for PAH75D48-3318 model. There is no trim option for this model.

i) Vo1 (3.3V): output adjust down

$$R_{adj1}(\text{down}) = \left(\frac{3.4814 - \Delta Vo(2.69)}{\Delta Vo} \right) k\Omega$$

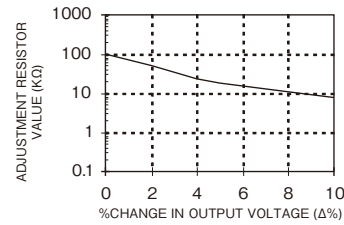

ii) Vo2 (1.8V): output adjust down

Tune-down of Vo2 is not applicable.

iii) Vo1 (3.3V): output adjust up

$$R_{adj1}(\text{up}) = \left(\frac{2.0956 - \Delta Vo}{\Delta Vo} \right) k\Omega$$

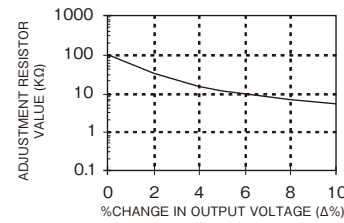

iv) Vo2 (1.8V): output adjust up

$$R_{adj2}(\text{up}) = \left(\frac{9.28 - \Delta Vo}{\Delta Vo} \right) k\Omega$$

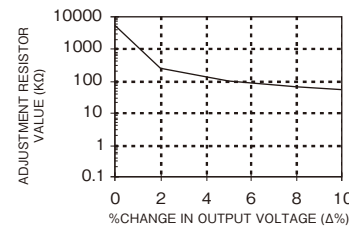

6) PAH75D48-2518 – Output Adjustment

Followings show the equations and graphs for the required external resistor to tune down and up output voltage for PAH75D48-2518 model. There is also no trim option for this model.

i) Vo1 (2.5V) & Vo2 (1.8V): output adjust down

Tune down of Vo1 and Vo2 is not applicable

ii) Vo1 (2.5V): output adjust down

$$R_{adj1}(\text{up}) = \left(\frac{2.542 - \Delta Vo}{\Delta Vo} \right) k\Omega$$

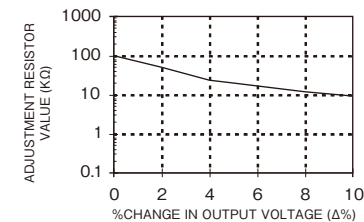

iii) Vo2 (1.8V): output adjust up

$$R_{adj2}(up) = \left(\frac{9.28 - \Delta Vo}{\Delta Vo} \right) k\Omega$$

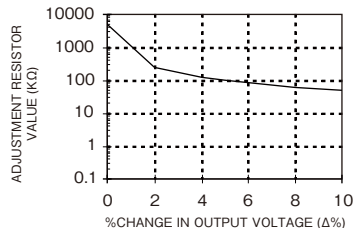

5 Output Ripple & Noise Measurement Method

The standard measurement for output ripple and noise are based on normal probe with 20MHz bandwidth scope. Upon measurement of the ripple voltage, make sure that the oscilloscope probe leads are not too long.

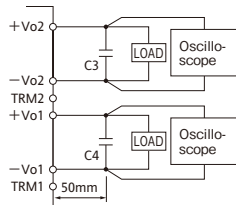

1) Specification

The ripple & noise specification for operating range between -40°C to 100°C is shown below.

i) 5V & 3.3V

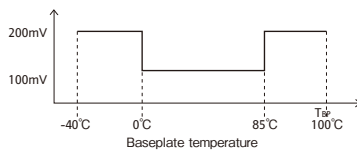

ii) 2.5V & 1.8V

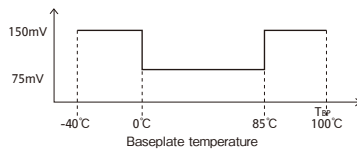

iii) JEITA measurement method

Below results are for reference only which is based on JEITA standard (JEITA probe with 100MHz bandwidth scope). The measurement condition is Vin=48V and Tbp =25°C .

PAH75D48-5033

Load Condition	Vo1 (5V)	Vo2 (3.3V)
Io1=15A ; Io2=0A	50mV	43mV
Io1=0A ; Io2=15A	40mV	36mV
Io1=5A ; Io2=15A	51mV	60mV

PAH75D48-3325

Load Condition	Vo1 (3.3V)	Vo2 (2.5V)
Io1=15A ; Io2=0A	46mV	33mV
Io1=0A ; Io2=15A	48mV	46mV
Io1=5A ; Io2=15A	42mV	33mV

PAH75D48-3318

Load Condition	Vo1 (3.3V)	Vo2 (1.8V)
Io1=15A ; Io2=0A	49mV	33mV
Io1=0A ; Io2=15A	46mV	48mV
Io1=5A ; Io2=15A	42.5mV	40mV

PAH75D48-2518

Load Condition	Vo1 (2.5V)	Vo2 (1.8V)
Io1=15A ; Io2=0A	32mV	36mV
Io1=0A ; Io2=15A	35mV	34mV
Io1=5A ; Io2=15A	40.5mV	35mV

6 Maximum Line Regulation

Maximum line regulation is the maximum output voltage change when the input voltage is slowly varied within the input voltage range. The measurement point for the input and output voltages are ±Vin , ±Vo1 and ±Vo2 respectively.

7 Maximum load regulation

Maximum load regulation is the maximum output voltage value change when varying the load current slowly within the standard output current range. The measurement point for the input and output voltages are ±Vin, ±Vo1 and ±Vo2 respectively.

PAH

8 Brownout

There will be output voltage overshoot during brown-out (momentary input line off) condition.

9 Over Current Protection

The PAH75D48 SERIES is equipped with an over current protection circuit. When the short or overload condition is removed, the output will automatically recover. This setting is fixed and cannot be varied externally. If the short or overload condition continues, the power module could be damaged due to the heat condition.

10 Over Voltage Protection

There are 2 types of over voltage protection method available for PAH75D48 SERIES. In the standard model, a latching shutdown method is adopted. For this method there are two ways to reset the power module after OVP protection triggers. They are by (i) giving a pulse to the control pin or (ii) recycling the input voltage. In the /V optional model, the power module will shutdown after OVP protection triggers but will recover automatically when over voltage is removed.

11 Thermal Protection

The PAH75D48 SERIES have a thermal protection circuit that senses the baseplate temperature between the range of 105°C to 130°C for an over temperature condition. Under a condition where the ambient temperature or the

power module internal temperature rises excessively, the thermal protection circuit will shut down the power module. The power module will recover automatically when the baseplate temperature cools down.

12 ON/OFF Control (CNT)

Without turning the input on and off, the output can be enabled and disabled using this function. This control circuit is on the input side of the power module; CNT terminal pin. There are two options available in this function, which are Negative Logic and Positive Logic. In the standard model where Negative Logic is used, power module will turn on when the CNT terminal pin is shorted to -Vin or a low logic voltage is provided. The Power module will turn off when CNT terminal pin is open or Logic high is provided. In the /P optional model where Positive Logic is used, the control method is vice versa to Negative logic.

The maximum CNT pin voltage when it is opened is 7V. The maximum low logic sourcing current is 0.6mA. When using this function, attach a 0.1uF capacitor between the CNT and -Vin terminals as close as possible.

PAH

Remote ON/OFF control can also be exercised by opening or closing the contacts of a switch or relay, or by operating a transistor as a switch in series with the CNT terminal.

Standard remote ON/OFF control circuit is provided in the primary circuit. For secondary control, isolation can be achieved through use of an optocoupler or relay.

CNT Connection Method

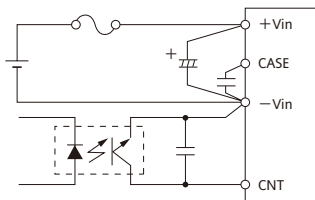

Below tables summarize the CNT levels and output states with different logic types.

a) Negative Logic: (Standard model)

CNT Level for INPUT -V	OUTPUT
H (more than 2.0V) or Open	OFF
L (less than 1.0V) or Short	ON

b) Positive Logic: (/P option)

CNT Level for INPUT -V	OUTPUT
H (more than 2.0V) or Open	ON
L (less than 1.0V) or Short	OFF

13 Operation Temperature

The baseplate temperature range for PAH75D48 SERIES is from -40°C to 100°C .

14 Operation Humidity

Avoid the buildup of condensation on or in the power module.

15 Storage Temperature

Please note that sudden temperature changes can cause condensation buildup, and other harmful affects to each terminal solder.

16 Storage Humidity

High temperature and humidity can cause the terminals on the module to oxidize. The quality of the solder will become worse.

17 Cooling Method

The operating temperature is specified by the baseplate temperature. Various cooling methods are possible such as using heatsink or chassis of the equipment. If the temperature is very high, fan is recommended.

18 Baseplate Temperature vs. Output Regulation

This is the output voltage change ratio when varying the baseplate operation temperature.

19 Withstand Voltage

The power module is designed to withstand 1.5kVDC between the input to the baseplate and input to output for 1 minute. In the case that the withstand voltage is tested in the incoming goods test, etc., please set the limit of the test equipment to 20 mA. The applied voltage must be increased gradually from zero to the testing value, and then decreased gradually at shutdown. Do not use a timer where a pulse of several times the applied voltage can be generated. This could cause damage to the module. Be sure to short all the input and output pins as shown below.

(Input - Baseplate)

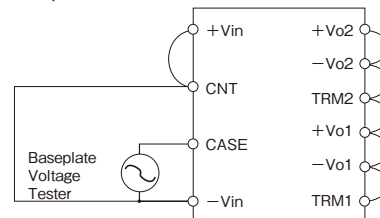

1.5kVDC 1 min. (20mA)

Note: Please be sure to short all the input & output pins as shown above.

(Input - Baseplate)

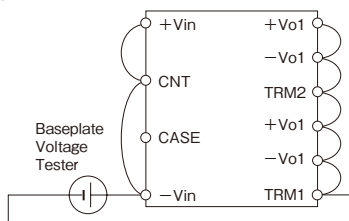

1.5kVDC 1 min.(20mA)

Note: Please be sure CASE is not shorted to any pins.

20 Isolation Resistance

The isolation resistance is more than 100M Ω at 500VDC when tested with a DC isolation tester between the output and the baseplate. Make sure that during testing, the isolation testers does not produce a high pulse when the applied voltage is varied. Ensure that the tester is fully discharged after the test.

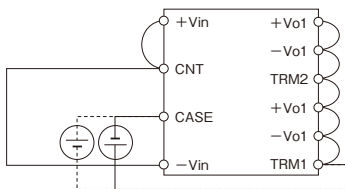

21 Vibration

Please refer to the power module mounting in the PAH75D48 SERIES Handbook in order to achieve vibration level stated in the specification.

22 Shock

Value for the conditions of our shipping and packaging.

23 Others





The performance of a system with Power Module is influenced according to various conditions -- PCBs, chassis, mechanics, heat dissipation.

Please evaluate actual products, and confirm its performance.

Please refer to "Power Module Application Note" for thermal design and mounting direction.

PAH

PAH200H Instruction Manual

- PAH300S24, 350S24 Instruction Manual  B-169Page
- PAH50S48 ~ 200S48 Instruction Manual  B-177Page
- PAH300S48, 350S48 Instruction Manual  B-182Page
- PAH450S48 Instruction Manual  B-190Page
- PAH75D Instruction Manual  B-199Page

Before Using This Power Module

Be sure to take note of precautions and warnings indicated in this manual when using this product. Improper usage may lead to electric shock or fire. Be sure to read this instruction manual thoroughly before using this product.

Caution

- There are high voltage and high temperature components within this product. Refrain from disassembling this product or touching its internal components as this may lead to electric shock or burned.
- When the unit is operating, keep your hands and face away from the unit. You may get injured by accident.
- Confirm connections to input/output terminals and signal terminals are correct as indicated in the instruction manual.
- Attach a fast blow type external fuse to each module to ensure safety operation and compliance to each safety standard approval.
- This power module is designed for professional installation within the end user equipment.
- Use isolated voltage by reinforced or double insulation as

input power source.

- Do not inject abnormal voltage to output terminal and signal terminal from the outside.
The injection of reverse voltage or over voltage exceeding nominal output voltage to output terminals might cause Damage to internal output capacitor (Functional Polymerized Capacitor)
- The application circuits and their parameter are for reference only. Be sure to verify effectiveness of application circuits and their parameters before finalizing circuit design.
- The information in this document is subject to change without prior notice. For actual design-in, please refer to the latest publications of data sheet, etc., for the most up-to-date specifications of the unit.
- No part of this document may be copied or reproduced in any for, or by any mean without prior written consent of Den-sei-Lambda.

Note : CE Marking

CE Marking, when applied to a product covered by instruction manual, indicates compliance with the low voltage directive which complies with EN60950

1. Terminal Explanation

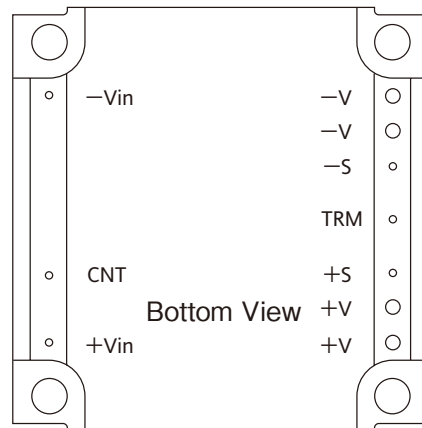

Input and Output Terminal Configurations(Bottom View)

[Input terminal]

-Vin: -Input Terminal
CNT: ON/OFF Control Terminal
+Vin: +Input Terminal

[Output terminal]

-V: -Output Terminal
-S: -Remote Sensing Terminal
TRM: Output Voltage Trimming Terminal
+S: +Remote Sensing Terminal
+V: +Output Terminal

Please ensure good connectivity to minimize the connection resistance for terminal +Vin, -Vin, +V and -V.

2. Explanation on Specifications

1 Input Voltage Range

Input voltage Range for PAH200H48 Series is indicated below.

Input Voltage Range: 36 - 76VDC

Maximum Applied Surge Voltage:

100VDC, 100ms

Basically, ripple voltage (V_{rpl}) which results from rectification and filtering of commercial AC line is included within the input voltage as shown in Fig.1-1.

Ripple voltage must be limited within the voltage described below.

Allowable input ripple voltage: 4Vp-p

When this value is exceeded, the output ripple voltage becomes large.

Note that abrupt input voltage change may cause the output voltage to fluctuate transitionally.

Also, input voltage waveform peak value must not exceed above input voltage range.

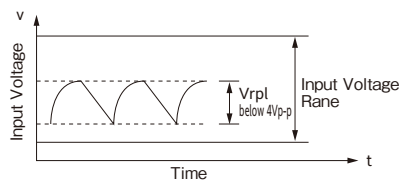

Fig.1-1 Input Ripple Voltage

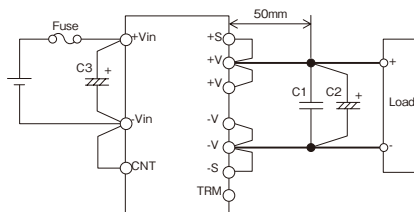

Fig.1-2 Basic Connection

(Standard Model: Negative Logic type for ON/OFF Control)

Input Fuse

PAH200H48 Series module is not internally fused. To ensure safe operation and to receive each Safety Standard approval, please connect an external fuse (fast-blow type) as shown in Fig.1-2.

Fuse must be connected to the +Vin side if -Vin side is used as a ground, or fuse must be connected to -Vin side if +Vin side is used as a ground.

Recommended input fuse current rating:

PAH200H48: 10A

C1: 1 μ F, C2: 10 μ F

To reduce spike noise voltage at the output, connect 1 μ F ceramic capacitor and 10 μ F electrolytic capacitor or tantalum capacitor between +V and -V within 50mm distance from the output terminals.

Also, take note that output spike noise voltage could vary according to PCB wiring design.

Maximum capacitance of electrolytic capacitor that can be connected between +V and -V, is total 10,000 μ F.

C3:

Input capacitor C3 is recommended to stabilize to module when the module is powered from a high impedance source.

Select the electrolytic capacitor with low ESR and sufficient allowable ripple current.

Verify actual ripple current value by actual measurement.

**Recommended capacitor value: 100 μ F and above
(voltage rating 100V or above)**

Note) 1. Use low impedance electrolytic capacitor with excellent temperature characteristics.

(Nippon Chemicon LXV Series or equivalent)

2. When input line inductance becomes excessively high due to insertion of choke coil operation of the power module could become unstable. For this case, increase C3 value more than the value indicated above.
3. When ambient temperature becomes lower than -20°C , connect two capacitors indicate above in parallel

C4:

When switches or connectors are used between input source and PAH200H48 Series input terminals, impulse surge voltage is generated due to input throw-in by switch on/off or due to inserting/removing of power module from the active line. For this case, connect an additional electrolytic capacitor C4 as shown in fig.1-3 and fig.1-4.

**Recommended Capacitor: 100 μ F and above
(Voltage Rating 100V or above)**

Also, in-rush current flows at line throw-in.

Therefore, be sure to verify capability of switch or fuse to withstand I^2t at line throw-in.

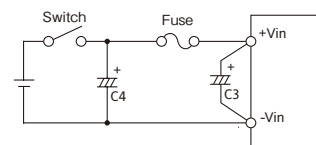

Fig.1-3 Input filter (C4) with Switch

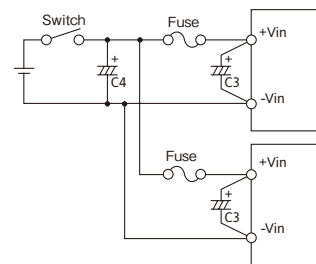

Fig.1-4 Input Filter with Switch when Plural Power

Reverse input connections

Reverse input polarity would cause module damage.

For cases where reverse connections are possible, connect a protective diode and fuse. Use protective diode with higher voltage rating than the input voltage, and with higher surge current rating than the fuse.

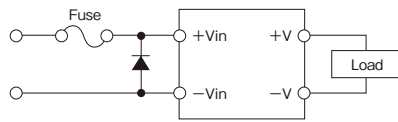

Fig.1-5 Protection for Reversed Input Connection

2 Output Voltage Adjustment Range

Output voltage could be adjusted within the range described below by external resistor or variable resistor. However, take note that OVP might trigger when output voltage adjustment exceeds the ranges indicated below.

Output Voltage Adjustment Range

3.3V: -15% - +15% of nominal output Voltage

1.8V, 2.5V: -20% - +10% of nominal output Voltage

When increasing the output voltage reduce the output current accordingly so as not to exceed the maximum output power.

For 3.3V output model, take note that when output voltage is increased, input voltage range is limited as shown in fig.2-1.

Also, when output voltage is decreased under output adjustment range, output voltage will shut off.

Remote sensing is possible even when output voltage is varied. For details on remote sensing function, please refer to "9. Remote Sensing"

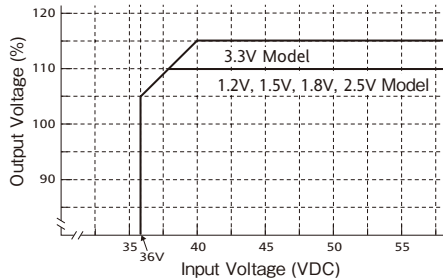

Fig.2-1 Limit of Input Voltage

Output Voltage Adjustment by external resistor or by variable resistor

(1) In case of adjusting output voltage lower

(1-1) Available maximum output current = rated output current

(1-2) Connect an external resistor R_{adj}(down) between the TRM terminal and -S terminal.

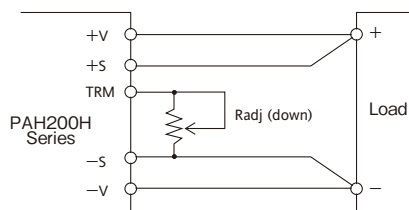

Fig.2-2 Connection for output voltage trim down (1)

(1-3) Equation of external resistor and output voltage.

(1R8, 2R5, 3R3)

$$R_{adj}(\text{down}) = \left[\frac{100\%}{\Delta\%} - 2 \right] [k\Omega]$$

(1R5)

$$R_{adj}(\text{down}) = \left[\frac{2.67 \times 100\%}{\Delta\%} - 3.67 \right] [k\Omega]$$

(1R2)

$$R_{adj}(\text{down}) = \left[\frac{1.67 \times 100\%}{\Delta\%} - 2.67 \right] [k\Omega]$$

R_{adj} (down) : Value of external resistor

Δ (%): Output voltage change rate against nominal output voltage

Below graph is relation Δ% and value of external resistor.

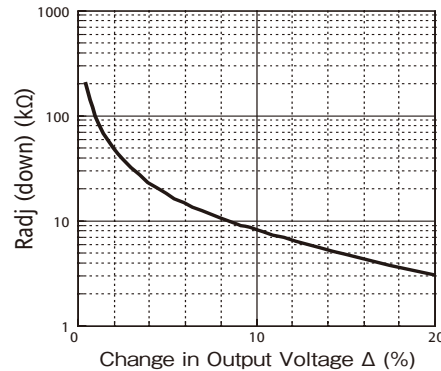

Fig.2-3 Δ (%) vs. R_{adj}(down) (1)

(2) In case of adjusting output voltage higher

(2-1) Allowable maximum output current = value of output power ÷ output voltage (reduce maximum output current in specification.)

(2-2) Connect an external resistor R_{adj} (up) between TRM terminal and +S terminal

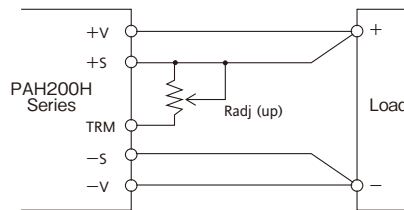

Fig.2-4 Connection for output voltage trim up (2)

(2-3) Equation of external resistor and output voltage

(1R8, 2R5, 3R3)

$$R_{adj}(\text{up}) = \left[\frac{V_o (100\% + \Delta\%) - 100\% + 2 \times \Delta\%}{1.225 \times \Delta\%} \right] [k\Omega]$$

(1R5)

$$R_{adj}(\text{up}) = \left[\frac{1.26 \times 100\%}{\Delta\%} + 0.2 \right] [k\Omega]$$

(1R2)

$$R_{adj}(\text{up}) = \left[\frac{0.78 \times 100\%}{\Delta\%} - 0.22 \right] [k\Omega]$$

V_o: nominal output value of module

R_{adj} (up) : external adjustment resistor

Δ (%): Output voltage change rate against nominal output voltage

Ex.) To adjust to 3.63V for 3.3V nominal model, setting level is +10% , therefore Δ (%) = 10% .

Below graph is relation $\Delta(\%)$ and value of external resistor.

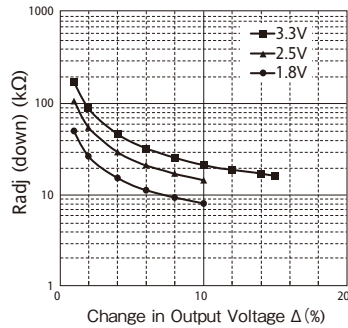

Fig.2-5 $\Delta\%$ vs.Radj (up) (2)

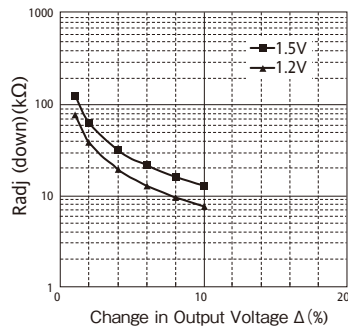

Fig.2-6 $\Delta(\%)$ vs.Radj (down) (3)

(3) To adjust output voltage for whole range Resistor values, as well as, connecting methods for external resistor (R1) and external variable resistor (VR) are described below.

	1.8V	2.5V	3.3V
R1	2.2k	1k	2.2k
VR	1k	2k	2k

unit: [Ω]

Table 2-3 Value of External Resistor and Variable Resistor

$$\left[\begin{array}{l} V_o \text{ } -20\%, +10\% \text{ (1.8V,2.5V)} \\ V_o \text{ } \pm 15\% \text{ (3.3V)} \end{array} \right]$$

	1.8V	2.5V	3.3V
R1	5.6k	3.3k	5.6k
VR	500	1k	1k

unit: [Ω]

Table 2-4 Value of External Resistor and Variable Resistor ($\pm 10\%$ Variable)

R1: $\pm 5\%$ Tolerance
 VR: $\pm 20\%$ Tolerance
 with end resistance below 1%

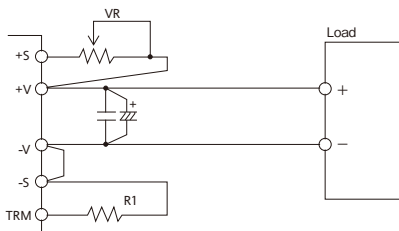

Fig.2-6 Example connection of external resistor

3 Maximum Ripple and Noise

(1) Measurement based on JEITA RC-9141
 Measure according to the specified methods (Fig.3-1) based on JEITA RC-9141(Clause 7.12 and 7.13) which is described in the following. Connect capacitors (C1: ceramic capacitor $1\mu\text{F}$, C2: tantalum capacitor $10\mu\text{F}$) at 50mm distance from the output terminals. Measure at ceramic capacitor (C1) leads as shown in fig.3-1 using coaxial cable with JEITA attachment. Use oscilloscope with 100MHz frequency bandwidth or equivalent.

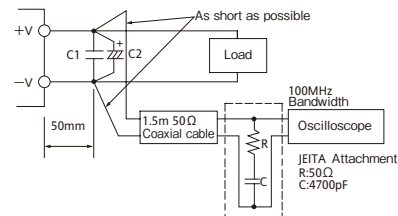

Fig.3-1 Measurement of Maximum Output Ripple & Noise Based on JEITA RC-9141

(2) Measurement using coaxial cable
 Measure according to Fig.3-2. Connect capacitors (C1: ceramic capacitor $1\mu\text{F}$, C2: tantalum capacitor $10\mu\text{F}$) at 50mm distance from the output terminals. Measure at ceramic capacitor (C1) leads using coaxial cable. Use oscilloscope with 20MHz frequency bandwidth or equivalent.

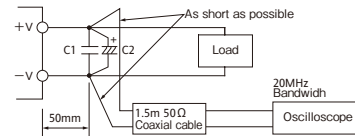

Fig.3-2 Measurement of Maximum Output Ripple & Noise Using coaxial cable

Take note that output ripple voltage and output spike noise may vary depending on PCB wiring design. Generally output ripple voltage and output spike noise can be reduced by increasing value of external capacitor.

4 Maximum Line Regulation

Maximum line regulation is the maximum value of output voltage change when input voltage is gradually varied within specified input voltage range. The measurement point for the input and output voltage are $\pm V_{in}$ and $\pm S$ (sense point) respectively.

5 Maximum Load Regulation

Maximum value of output voltage change when output current is gradually varied within specified output current range. The measurement point for the input and output voltage are $\pm V_{in}$ and $\pm S$ (sense point) respectively. When using at dynamic load mode, audible noise may be heard from the power module and output voltage fluctuation might increase.

6 Over Current Protection (OCP)

This power module has built-in OCP function. Output will recover when short circuit or overload conditions are released. OCP setting value is fixed and therefore, can not be externally adjusted. Also, take note, when

PAH

output voltage drops down below lower side of adjustment range for 20ms - 50ms by output short circuit or over load conditions, output might be shut down.

Output can be recovered by manual reset of the control ON/OFF terminal or by turning input line off and then turning it on again.

7 Over Voltage Protection (OVP)

This power module has built-in OVP function.

OVP set point is relative to the rated output voltage value. When output voltage exceeds OVP set point, output voltage shuts down. OVP set point is fixed and therefore can not be changed. When OVP is triggered, output can be recovered by turning input line off and then turning it on again after lowering the input voltage below the voltage value indicated below or by manual reset of the control ON/OFF terminal.

Input voltage for OVP reset: 24VDC and below

/V Option (automatic recovery)

The /V optional model will re-start with delay of 100ms ~ 400ms after shutdown by OCP or OVP triggering. When over voltage and over current are removed, output will recover normally.

Verifying OVP function shall be done by increasing output voltage with external resistor. For verifying OVP function, avoid applying external voltage to output terminal because this will cause power module damage.

8 Over Thermal Protection (OTP)

This power module has built-in OTP function. This function operates and shuts down the output when temperature of the power module rises abnormally. Take note that OTP will operate again unless the cause of abnormal heat of the power module is eliminated.

For the details of OTP, refer to the clause of "Mounting Method and Thermal Condition"

9 Remote Sensing (+S, -S Terminal)

Remote sensing terminal is provided to compensate for voltage drop across the wiring from the power module output terminal to the load input terminal.

When remote sensing function is not used (local sensing), short +S terminal to +V terminal and, -S terminal to -V terminal.

Fig.9-1 indicates connections when the remote sensing terminal is used. For optimum operations, connect electrolytic capacitor as large capacity as possible (within 10,000 μ F) between +V and -V terminal, as well as across the load terminals. Take note that voltage compensation range for line drop (voltage drop due to wiring) should be kept such that output voltage at the output terminals is within output voltage range and the maximum power doesn't exceed Use shielded wire, twist pair, or parallel pattern to reduce noise effect. When the remote sensing terminal is used, if the load wiring impedance is large, output power may disrupt the stability. To reduce the load wiring impedance, wiring should be thick and short as much

as possible. When using the lead wiring, the wire should be twist pair, or when using the pattern, use the pattern layout as shown in fig.9-3 to reduce the impedance as small as possible.

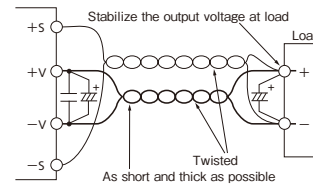

Fig.9-1 Remote Sensing in Use

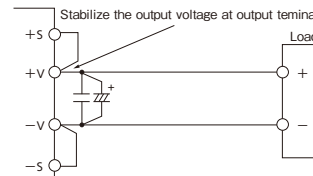

Fig.9-2 Remote Sensing Not in Use (Local Sensing)

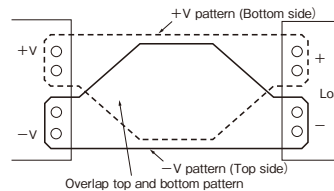

Fig.9-3 Example of Load Wiring Pattern Layout in using the double-sided PCB

10 ON/OFF Control (CNT Terminal)

Without turning the input supply on and off, the output can be enabled and disabled using this function. This function also can be used for output sequence of plural modules. There are two kind of logic control, negative logic control and positive logic control, depend on the option selected. ON/OFF control circuit is on the primary side (the input side), CNT Terminal pin. For secondary control, isolation can be achieved through the use of a opto coupler or relay.

	Logic	CNT Terminal Level to -Vin Terminal	Output status
Standard	Negative Logic	H Level ($4V \leq H \leq 35V$) or Open	OFF
[/V option]		L Level ($0V \leq H \leq 0.8V$) or Short	ON
[/P option]	Positive Logic	H Level ($4V \leq H \leq 35V$) or Open	ON
[/PV option]		L Level ($0V \leq H \leq 0.8V$) or Short	OFF

*When control function is not used for the Standard, CNT terminal is shorted to -Vin terminal.

*When using long wiring, for prevention of noise, attach a 0.1 μ F capacitor between CNT Terminal and -Vin terminal.

*At L level, maximum source current from CNT terminal to -Vin terminal is 0.5mA

*The maximum CNT Terminal voltage is 35V.

(1) Output ON/OFF control

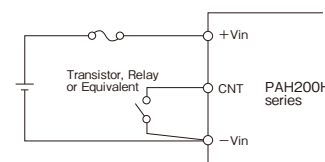

(2) Secondary (output side) control

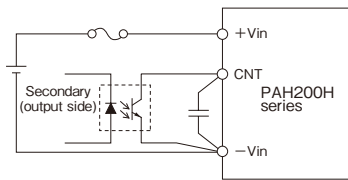

Fig.10-1 CNT Connection

11 Parallel Operation

Parallel Operation can not be used.

12 Series Operation

Series Operation is possible for PAH200H Series. For the number of maximum series connection, please contact us

(A) Series Operation in High Output Voltage

When Series Operation is used to obtain Higher Output Voltage, a bypass diode is needed to prevent the reverse voltage (refer Fig12-1.) The selection guide for this bypass diode is described below :

Condition of selection, bypass diode D1, D2

1. Peak Repeated Reverse Voltage
 $VRRM \geq$ duplicate of nominal output voltage of the power supply.
2. Average output current
 $I_o \geq$ duplicate of nominal output current of the power supply.
3. Forward voltage
 $V_F \geq$ The lowest
 (schottky barrier diode and equivalent)

Output reverse maximum applied voltage: 0.6VDC and below

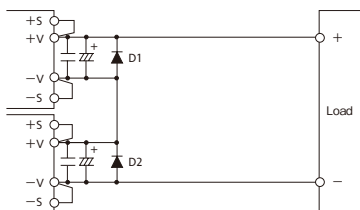

Fig.12-1 Series Operation for High Output Voltage

(B) ± Output Series Operation

When +load and -load is completely separated the bypass diode is not required.

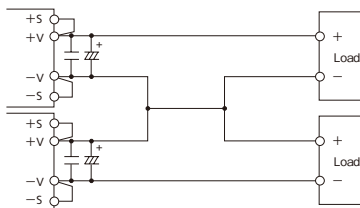

Fig.12-2 ± Output Series Operation

13 Operating Ambient Temperature

According to ambient temperature, output load should derated accordingly (refer to Mounting Method & Terminal Condition). There is no restriction on mounting direction but there should be enough consideration for airflow so

that heat does not accumulate around the power module vicinity.

Determine external components configuration and mounting direction on PCB such that air could flow through power module at forced air cooling or convection cooling. For better reliability, derating of ambient temperature is recommended. For details on derating, refer to "Mounting Method & Thermal Condition".

14 Operatin Ambient Humidity

Take note that moisture could lead to power module abnormal operation or damage.

15 Storage Ambient Temperature

Abrupt temperature change would cause condensation built-up that leads to poor solderability of terminals of the power supply.

16 Storage Ambient Humidity

High temperature and humidity can cause the terminals on the module to oxidize. The quality of the solder will become worse.

17 Cooling Method

Forced air cooling is recommended. Convection cooling is also possible. For the details of derating, refer to "Mounting Method and Thermal condition"

18 Ambient Temperature vs. Output Voltage Drift

Temperature coefficient is defined as the rate of voltage change when ambient temperature is changed during operation.

19 Withstand Voltage

This power module is designed to have a withstand voltage of 1.5kVAC between input and output. When conducting withstand voltage test during incoming inspection, set the current limit value of the withstand voltage testing equipment to 20mA. Furthermore, avoid throw in or shut off of the testing equipment when applying or when shutting down the test voltage. Instead, gradually increase or decrease the applied voltage. Take note especially not to use the timer of the test equipment because when the timer switches the applied voltage off, impulse voltage which has several times the magnitude of the applied voltage is generated causing damage to the power module. Short the output side as shown in fig.19-1.

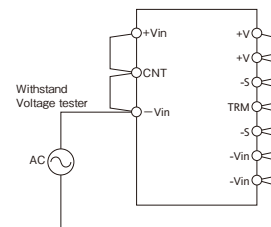

1.5kVAC 1minute (20mA)

Fig.19-1 Withstand Voltage Test for Input-Output

20 Insulation Resistance

Use DC insulation tester (MAX 500V) between output and

PAH

input. Insulation resistance value is 100MΩ and above at 500VDC applied voltage. Make sure that during testing, the isolation testers does not produce a high pulse when the applied voltage is varied. Ensure that the tester is fully discharged after the test.

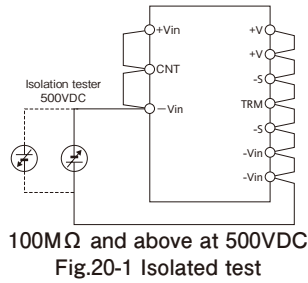

21 Vibration

Vibration of power module is defined in case of mounting on PCB.

23 Shock

Value for the conditions of out shipping and packing.

3. Mounting Method and Thermal Condition

1 Output Derating

(1) Output Derating by ambient temperature

There is no restriction on mounting direction but there should be enough consideration for airflow so that heat does not accumulate around the power module vicinity. Determine external components configuration and mounting direction on PCB such that air could flow through power module at forced air cooling or convection cooling. Take note, output power derating is needed as shown in followings. The derating curves provided is based on the below set-up condition.

PAH

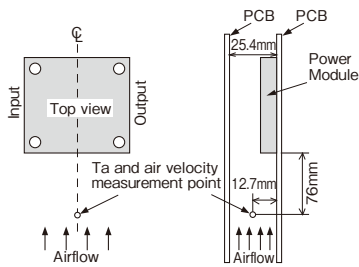

Fig.1-1 Output derating set-up condition

Fig. 1-2, 1-3, and 1-4 shows output derating vs ambient temperature.

In this case, natural convection cooling means occurrence of 0.2m/s airflow due to self heating of the power module. If the product is used out of derating curve, they shut down by OTP (over temperature protection). Please note that OTP cannot operate correctly when cooling is concentrated on thermal detector only

Output derating by ambient temperature

Vin=48VDC at standard vertical mounting

PAH200H48-1R8 (include /P, /V, /PV option)

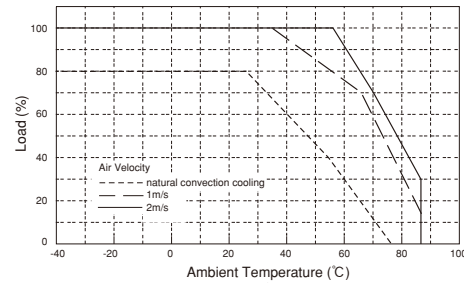

Fig.1-2

PAH200H48-2R5 (include /P, /V, /PV option)

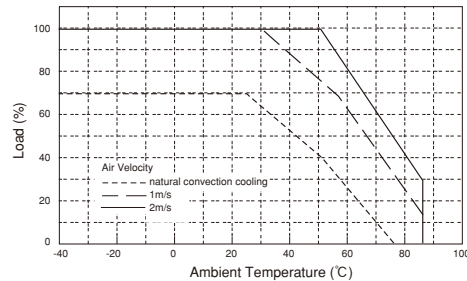

Fig.1-3

PAH200H48-3R3 (include /P, /V, /PV option)

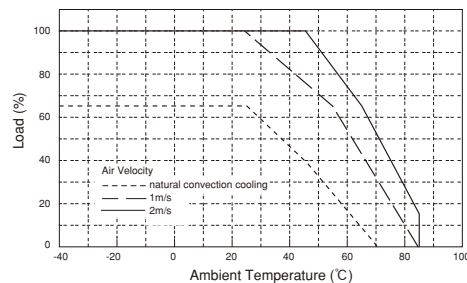

Fig.1-4

(2) Output derating by PCB

When use with different measurement conditions from output derating by ambient temperature, use output derating by PCB temperature as in Fig.1-6.

PCB temperature is decided by temperature of thermal sensor in below Fig.1-5. As the thermal sensor

terminals are exposed, when connecting thermocouple, please take sufficient insulation from terminals. Over Thermal Protection of power module is achieved by detecting the PCB temperature through thermal sensor. When the module operates over the output derating curve of PCB temperature, Over Thermal Protection (OTP) functions and output shut-down.

Therefore, measurement of PCB temperature is recommended to ensure the module to operate within the derating curve.

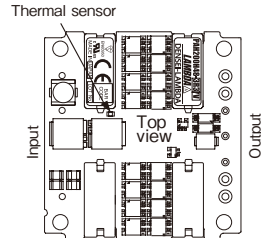

Fig.1-5 Thermal Sensor Position

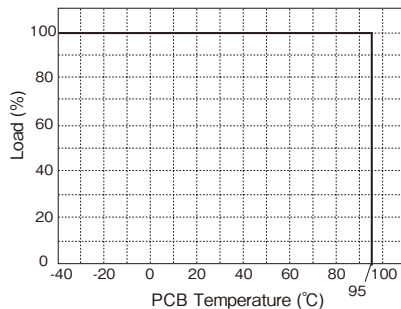

Fig.1-6 Output Derating by PCB Temperature

2 Mounting Method

- (1) Mounting hole on PCB
Diameter of hole and land of PCB with referring below.

Type	PAH200H48
Input Terminal Pin	φ 1.0mm
Hole Diameter	φ 1.5mm
Land Diameter	φ 3.0mm
Output Terminal Pin	φ 2.0mm
Hole Diameter	φ 2.5mm
Land Diameter	φ 4.5mm
Signal Terminal Pin	φ 1.0mm
Hole Diameter	φ 1.5mm
Land Diameter	φ 3.0mm

For position of the holes, see outline drawing of the power module.

- (2) Output Terminal Pin
Connect +V, -V terminal pins such that the contact resistance becomes minimal. Note that large contact resistance could result into reduction of efficiency and abnormal temperature rise at terminal connections
- (3) Output Pattern Width
Large output current flows through the output pattern. If pattern is too narrow, voltage drop will occur and heat on pattern will increase. Relationship of current and the pattern width varies depending on materials of printed circuit board, conductor width, maximum allowable temperature rise of the pattern etc.. Confirmation on manufactures of printed circuit board is definitely necessary for designing.

3 Recommended Soldering Method

- (1) Soldering dip
260°C within 6 seconds
Pre-heat condition
110°C 30 - 40 seconds
- (2) Soldering iron
350°C within 3 seconds

4 Recommended Cleaning Condition

Recommended cleaning condition after soldering is as follows.

- Cleaning solvent
IPA (isopropyl alcohol)
- Cleaning Procedure
Use brush and dry the solvent completely.

Note) For other cleaning methods, contact us.

3. Before concluding power module damage

Verify following items before concluding power module damage.

- 1) No output voltage
 - Is specified input voltage applied?
 - Are the ON/OFF control terminal (CNT terminal), remote sensing terminal (+S,-S), output voltage trimming terminal (TRM) correctly connected?
 - For cases where output voltage adjustment is used, is the resistor or variable resistor setting, connections correctly done?
 - Are there no abnormalities in the output load used?
 - Is the ambient temperature within the specified temperature derating curve?
- 2) Output voltage is high.
 - Are the remote sensing terminals (+S, -S) correctly connected?
 - Is the measurement done at the sensing points?
 - For cases where output voltage adjustment is used, is the resistor or volume setting, connections correctly done?
- 3) Output voltage is low
 - Is specified input voltage applied?
 - Are the remote sensing terminals (+S, -S) correctly connected?
 - Is the measurement done at the sensing points?
 - For cases where output voltage adjustment is used, is the resistor or variable resistor setting, connections correctly done?
 - Are there no abnormalities in the output load used?
- 4) Load regulation and line regulation is large
 - Is specified input voltage applied?
 - Are the input terminals and the output terminals firmly connected?
 - Is the measurement done at the sensing points?
 - Is the input or output wire too thin?
- 5) Output ripple voltage is large
 - Is the measuring method used the same or equivalent with the specified method in the Application Notes?
 - Is the input ripple voltage value within the specified value?

TDK·Lambda