

## JAHW050A, JAHW075A and JAHW100A Power Modules: dc-dc Converters; 36 to 75 Vdc Input, 5 Vdc Output; 50 to 100 W



The JAHW Series Power Modules use advanced, surface-mount technology and deliver high-quality, efficient, and compact dc-dc conversion.

### Applications

- Distributed power architectures
- Workstations
- Computer equipment
- Communications equipment

### Options

- Choice of remote on/off logic configuration
- Latching protection features

### Description

The JAHW050A, JAHW075A and JAHW100A Power Modules are dc-dc converters that operate over an input voltage range of 36 Vdc to 75 Vdc and provide a precisely regulated dc output. The outputs are fully isolated from the inputs, allowing versatile polarity configurations and grounding connections. The modules have maximum power ratings from 50 W to 100 W at a typical full-load efficiency of 90%.

The sealed modules offer a metal baseplate for excellent thermal performance. Threaded-through holes are provided to allow easy mounting or addition of a heat sink for high-temperature applications. The standard feature set includes remote sensing, output trim, and remote on/off for convenient flexibility in distributed power applications.

### Features

- Small size: 61.0 mm x 57.9 mm x 12.7 mm (2.40 in. x 2.28 in. x 0.50 in.)
- High power density
- High efficiency: 90% typical
- Low output noise
- Constant frequency
- Industry-standard pinout
- Metal baseplate
- 2:1 input voltage range
- Overcurrent protection (hiccup mode)
- Remote on/off
- Adjustable output voltage
- Remote sense
- Output overvoltage protection (hiccup mode)
- Overtemperature protection (hiccup mode)
- Case ground pin
- ISO\* 9001 Certified manufacturing facilities
- Meets the voltage and current requirements for ETSI 300-132-2 and complies with and is Licensed for Basic Insulation rating per EN60950 (-B version only)
- UL† 60950 Recognized, CSA‡ 22.2 No. 60950-00 Certified, and VDE§ 0805 (IEC60950, IEC950) Licensed
- CE mark meets 73/23/EEC and 93/68/EEC directives\*\*

\* ISO is a registered trademark of the International Organization for Standardization.

† UL is a registered trademark of Underwriters Laboratories, Inc.

‡ CSA is a registered trademark of Canadian Standards Association.

§ VDE is a trademark of Verband Deutscher Elektrotechniker e.V.

\*\* This product is intended for integration into end-use equipment. All the required procedures for CE marking of end-use equipment should be followed. (The CE mark is placed on selected products.)

## Absolute Maximum Ratings

Stresses in excess of the absolute maximum ratings can cause permanent damage to the device. These are absolute stress ratings only. Functional operation of the device is not implied at these or any other conditions in excess of those given in the operations sections of the data sheet. Exposure to absolute maximum ratings for extended periods can adversely affect device reliability.

Parameter	Symbol	Min	Max	Unit
Input Voltage: Continuous	$V_I$	—	80	Vdc
Transient (100 ms)	$V_{I, trans}$	—	100	V
Operating Case Temperature (See Thermal Considerations section.)	$T_C$	-40	100	°C
Storage Temperature	$T_{stg}$	-55	125	°C
I/O Isolation Voltage (for 1 minute)	—	—	1500	Vdc

## Electrical Specifications

Unless otherwise indicated, specifications apply over all operating input voltage, resistive load, and temperature conditions.

**Table 1. Input Specifications**

Parameter	Symbol	Min	Typ	Max	Unit
Operating Input Voltage	$V_I$	36	48	75	Vdc
Maximum Input Current ( $V_I = 0$ V to 75 V; $I_O = I_{O, max}$ ):					
JAHW050A (See Figure 1.)	$I_{I, max}$	—	—	1.7	A
JAHW075A (See Figure 2.)	$I_{I, max}$	—	—	2.6	A
JAHW100A (See Figure 3.)	$I_{I, max}$	—	—	3.5	A
Inrush Transient	$i^2t$	—	—	1.0	A <sup>2</sup> s
Input Reflected-ripple Current, Peak-to-peak (5 Hz to 20 MHz, 12 $\mu$ H source impedance; see Figure 19.)	$I_r$	—	5	—	mAp-p
Input Ripple Rejection (120 Hz)	—	—	60	—	dB

## Fusing Considerations

**CAUTION: This power module is not internally fused. An input line fuse must always be used.**

This encapsulated power module can be used in a wide variety of applications, ranging from simple stand-alone operation to an integrated part of a sophisticated power architecture. To preserve maximum flexibility, internal fusing is not included; however, to achieve maximum safety and system protection, always use an input line fuse. The safety agencies require a normal-blow fuse with a maximum rating of 15 A (see Safety Considerations section). Based on the information provided in this data sheet on inrush energy and maximum dc input current, the same type of fuse with a lower rating can be used. Refer to the fuse manufacturer's data for further information.

## Electrical Specifications (continued)

**Table 2. Output Specifications**

Parameter	Device	Symbol	Min	Typ	Max	Unit
Output Voltage Set Point ( $V_I = 48\text{ V}$ ; $I_O = I_{O, \max}$ ; $T_C = 25\text{ }^\circ\text{C}$ )	All	$V_{O, \text{set}}$	4.92	5.0	5.08	Vdc
Output Voltage (Over all operating input voltage, resistive load, and temperature conditions until end of life. See Figure 21.)	All	$V_O$	4.85	—	5.15	Vdc
Output Regulation: Line ( $V_I = 36\text{ V}$ to $75\text{ V}$ ) Load ( $I_O = I_{O, \min}$ to $I_{O, \max}$ ) Temperature ( $T_C = -40\text{ }^\circ\text{C}$ to $+100\text{ }^\circ\text{C}$ )	All All All	— — —	— — —	0.01 0.05 15	0.1 0.2 50	% $V_O$ % $V_O$ mV
Output Ripple and Noise Voltage (See Figure 20.): RMS Peak-to-peak (5 Hz to 20 MHz)	All All	— —	— —	— —	50 100	mVrms mVp-p
External Load Capacitance (electrolytic)	All	—	0 <sup>‡</sup>	—	*	$\mu\text{F}$
Output Current (At $I_O < I_{O, \min}$ , the modules may exceed output ripple specifications.)	JAHW050A JAHW075A JAHW100A	$I_O$ $I_O$ $I_O$	0.5 0.5 0.5	— — —	10 15 20	A A A
Output Current-limit Inception ( $V_O = 90\%$ of $V_{O, \text{nom}}$ )	JAHW050A JAHW075A JAHW100A	$I_{O, \text{cli}}$ $I_{O, \text{cli}}$ $I_{O, \text{cli}}$	— — —	12 18 22	— — —	A A A
Output Short-circuit Current ( $V_O = 250\text{ mV}$ )	All	—	0	—	23	A
Efficiency ( $V_I = 48\text{ V}$ ; $I_O = I_{O, \max}$ ; $T_C = 70\text{ }^\circ\text{C}$ )	JAHW050A JAHW075A JAHW100A	$\eta$ $\eta$ $\eta$	— — —	89.5 90.4 91	— — —	% % %
Switching Frequency	All	—	—	340	—	kHz
Dynamic Response ( $\Delta I_O / \Delta t = 1\text{ A}/10\text{ }\mu\text{s}$ , $V_I = 48\text{ V}$ , $T_C = 25\text{ }^\circ\text{C}$ ; tested with a $10\text{ }\mu\text{F}$ tantalum and a $1.0\text{ }\mu\text{F}$ ceramic capacitor across the load.): Load Change from $I_O = 50\%$ to $75\%$ of $I_{O, \max}$ : Peak Deviation Settling Time ( $V_O < 10\%$ of peak deviation) Load Change from $I_O = 50\%$ to $25\%$ of $I_{O, \max}$ : Peak Deviation Settling Time ( $V_O < 10\%$ of peak deviation)	All All All All	— — — —	— — — —	5 200 5 200	— — — —	% $V_{O, \text{set}}$ $\mu\text{s}$ % $V_{O, \text{set}}$ $\mu\text{s}$

\* Stability consideration. (See Design Considerations, Output Capacitance Section)

† These are manufacturing test limits. In some situations, results may differ.

‡ Some characteristic are specified with  $10\text{ }\mu\text{F}$  aluminum and  $1\text{ }\mu\text{F}$  ceramic.

**Table 3. Isolation Specifications**

Parameter	Min	Typ	Max	Unit
Isolation Capacitance	—	2500	—	pF
Isolation Resistance	10	—	—	M $\Omega$

## General Specifications

Parameter	Min	Typ	Max	Unit
Calculated MTBF ( $I_o = 80\%$ of $I_{o, max}$ ; $T_c = 40\text{ }^\circ\text{C}$ )	2,000,000			hours
Weight	—	—	100 (3.5)	g (oz.)

## Feature Specifications

Unless otherwise indicated, specifications apply over all operating input voltage, resistive load, and temperature conditions. See Feature Descriptions for additional information.

Parameter	Symbol	Min	Typ	Max	Unit
Remote On/Off Signal Interface ( $V_i = 0\text{ V}$ to $75\text{ V}$ ; open collector or equivalent compatible; signal referenced to $V_i(-)$ terminal; see Figure 22 and Feature Descriptions.): JAHWxxxA1 Preferred Logic: Logic Low—Module On Logic High—Module Off JAHWxxxA Optional Logic: Logic Low—Module Off Logic High—Module On Logic Low: At $I_{on/off} = 1.0\text{ mA}$ At $V_{on/off} = 0.0\text{ V}$ Logic High: At $I_{on/off} = 0.0\text{ }\mu\text{A}$ Leakage Current Turn-on Time (See Figure 16.) ( $I_o = 80\%$ of $I_{o, max}$ ; $V_o$ within $\pm 1\%$ of steady state)	$V_{on/off}$ $I_{on/off}$ $V_{on/off}$ $I_{on/off}$ —	0 — — — —	— — — — 20	1.2 1.0 15 50 35	V mA V $\mu\text{A}$ ms
Output Voltage Adjustment (See Feature Descriptions.): Output Voltage Remote-sense Range Output Voltage Set-point Adjustment Range (trim)	— —	— 60	— —	0.5 110	V $\%V_{o, nom}$
Output Overvoltage Protection	$V_{o, sd}$	5.9*	—	7.0*	V
Overtemperature Protection (See Feature Descriptions.)	$T_c$	—	110	—	$^\circ\text{C}$

\* These are manufacturing test limits. In some situations, results may differ.

## Solder, Cleaning, and Drying Considerations

Post solder cleaning is usually the final circuit-board assembly process prior to electrical testing. The result of inadequate circuit-board cleaning and drying can affect both the reliability of a power module and the testability of the finished circuit-board assembly. For guidance on appropriate soldering, cleaning, and drying procedures refer to the *Board-Mounted Power Modules Soldering and Cleaning* Application Note (AP01-056EPS).

## Characteristic Curves

The following figures provide typical characteristics for the power modules. The figures are identical for both on/off configurations.

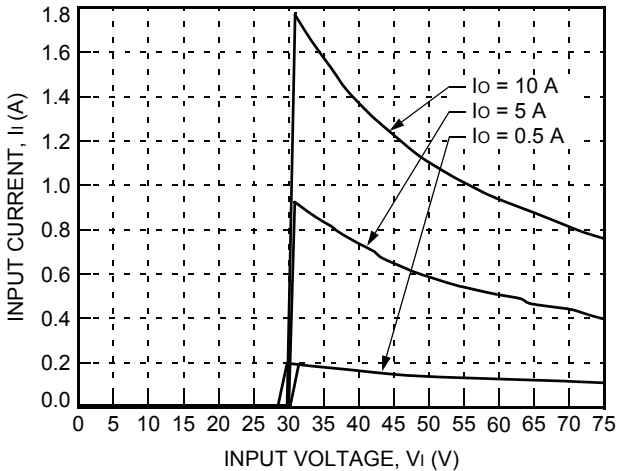

8-2241 (F)

Figure 1. Typical JAHW050A Input Characteristics at Room Temperature

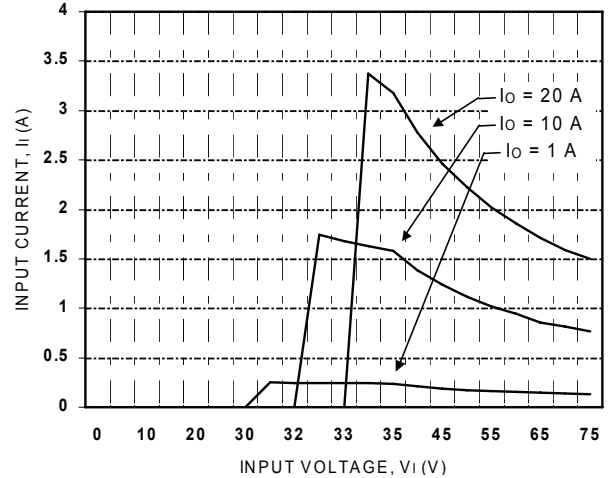

1-0462

Figure 3. Typical JAHW100A Input Characteristics at Room Temperature

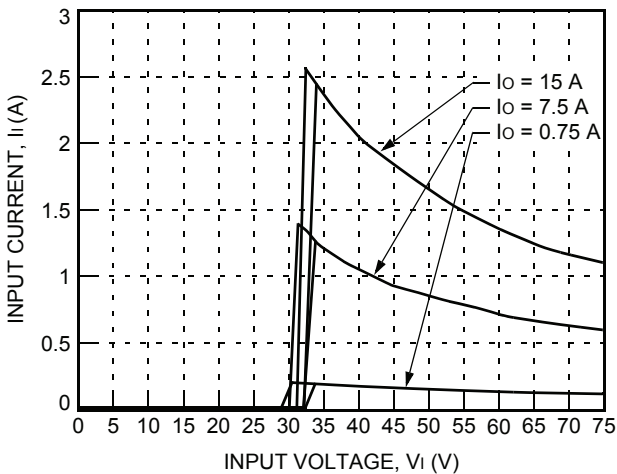

8-2075 (F)

Figure 2. Typical JAHW075A Input Characteristics at Room Temperature

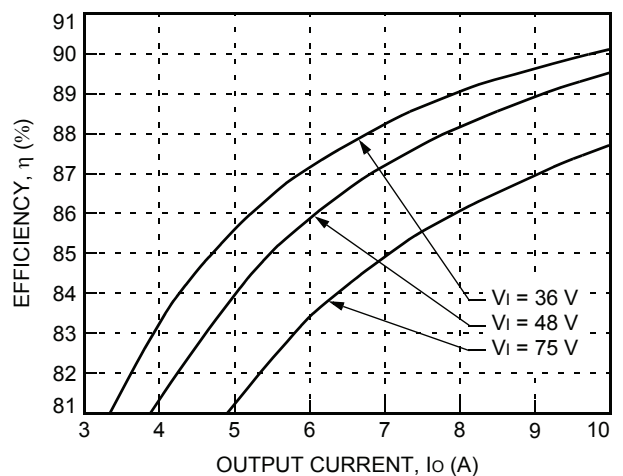

8-2242 (F)

Figure 4. Typical JAHW050A Converter Efficiency vs. Output Current at Room Temperature

Characteristic Curves (continued)

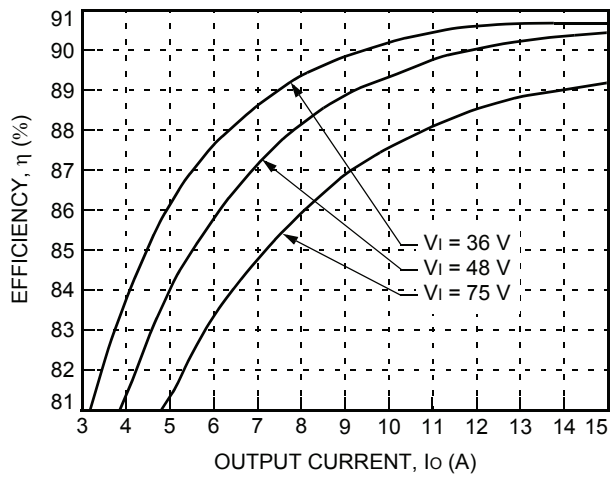

8-2076 (F)

Figure 5. Typical JAHW075A Converter Efficiency vs. Output Current at Room Temperature

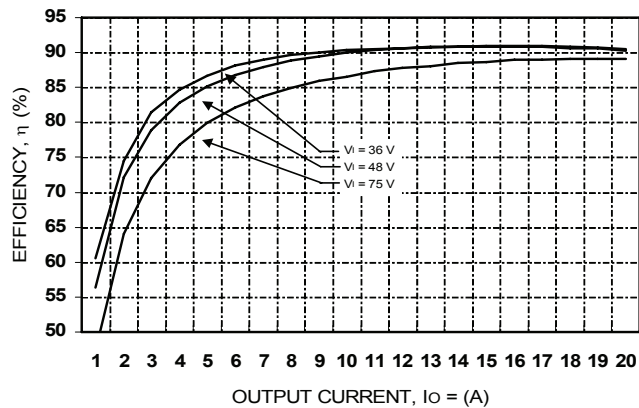

1-0463

Figure 6. Typical JAHW100A Converter Efficiency vs. Output Current at Room Temperature

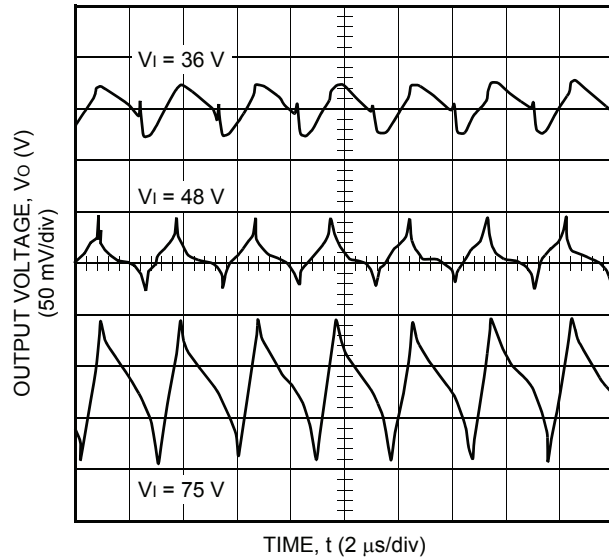

8-3201 (F)

Note: See Figure 20 for test conditions.

Figure 7. Typical JAHW050A Output Ripple Voltage at Room Temperature, I<sub>o</sub> = I<sub>o,max</sub>

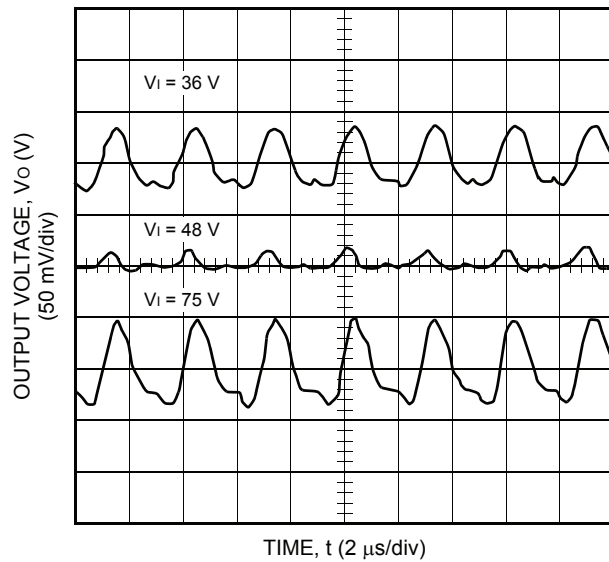

8-1884 (F)

Note: See Figure 20 for test conditions.

Figure 8. Typical JAHW075A Output Ripple Voltage at Room Temperature, I<sub>o</sub> = I<sub>o,max</sub>

Characteristic Curves (continued)

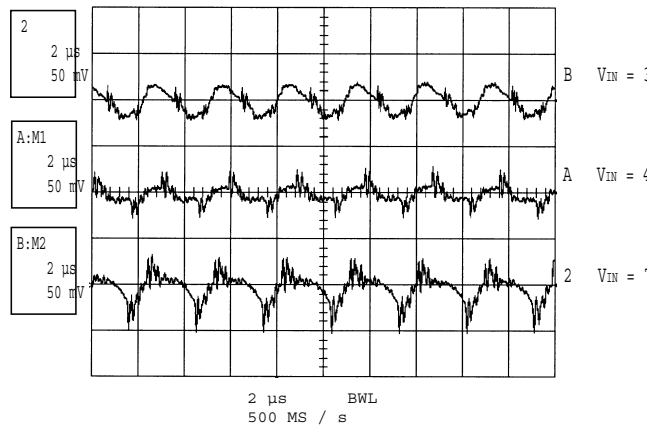

1-0461

Note: See Figure 20 for test conditions.

Figure 9. Typical JAHW100A Output Ripple Voltage at Room Temperature,  $I_o = I_{o, max}$

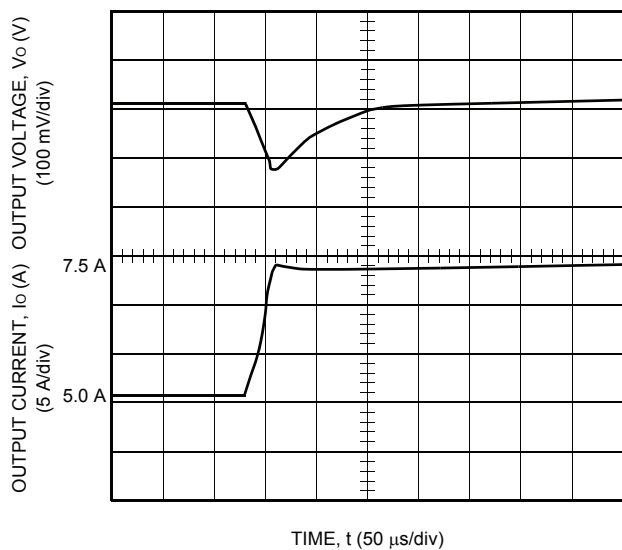

8-3203 (F)

Note: Tested with a 10  $\mu$ F tantalum and a 1.0  $\mu$ F ceramic capacitor across the load.

Figure 10. Typical JAHW050A Transient Response to Step Increase in Load from 50% to 75% of  $I_{o, max}$  at Room Temperature and 48 Vdc Input (Waveform Averaged to Eliminate Ripple Component.)

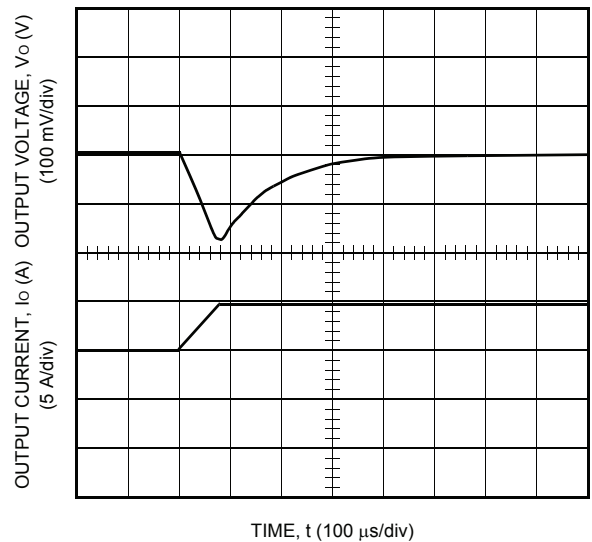

8-1886 (F)

Note: Tested with a 10  $\mu$ F tantalum and a 1.0  $\mu$ F ceramic capacitor across the load.

Figure 11. Typical JAHW075A Transient Response to Step Increase in Load from 50% to 75% of  $I_{o, max}$  at Room Temperature and 48 Vdc Input (Waveform Averaged to Eliminate Ripple Component.)

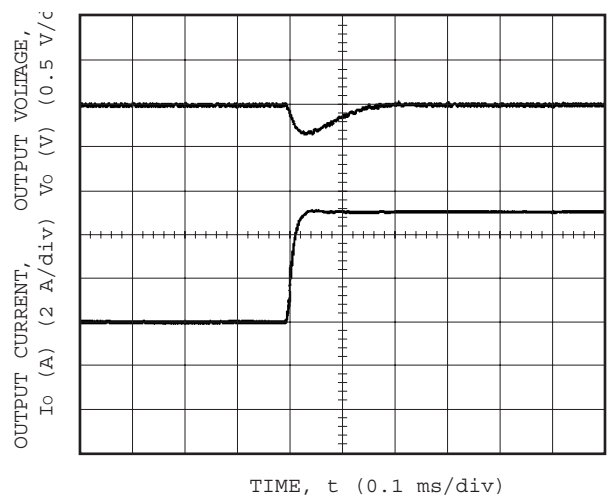

1-0456

Note: Tested with a 10  $\mu$ F tantalum and a 1.0  $\mu$ F ceramic capacitor across the load.

Figure 12. Typical JAHW100A Transient Response to Step Increase in Load from 50% to 75% of  $I_{o, max}$  at Room Temperature and 48 Vdc Input (Waveform Averaged to Eliminate Ripple Component.)

Characteristic Curves (continued)

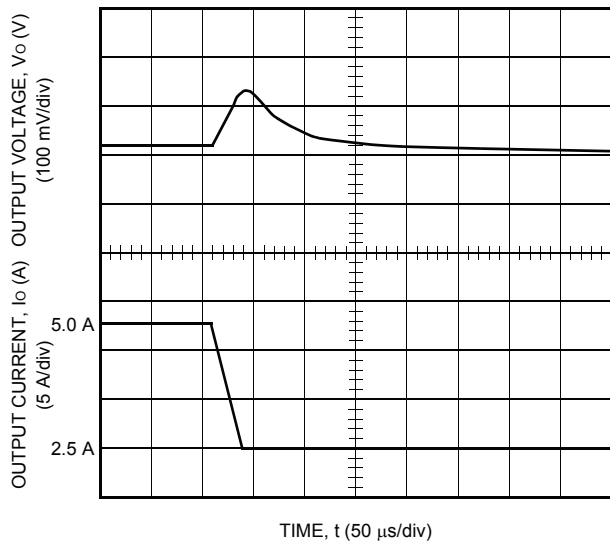

Note: Tested with a 10  $\mu$ F tantalum and a 1.0  $\mu$ F ceramic capacitor across the load.

**Figure 13. Typical JAHW050A Transient Response to Step Decrease in Load from 50% to 25% of  $I_{o, max}$  at Room Temperature and 48 Vdc Input (Waveform Averaged to Eliminate Ripple Component.)**

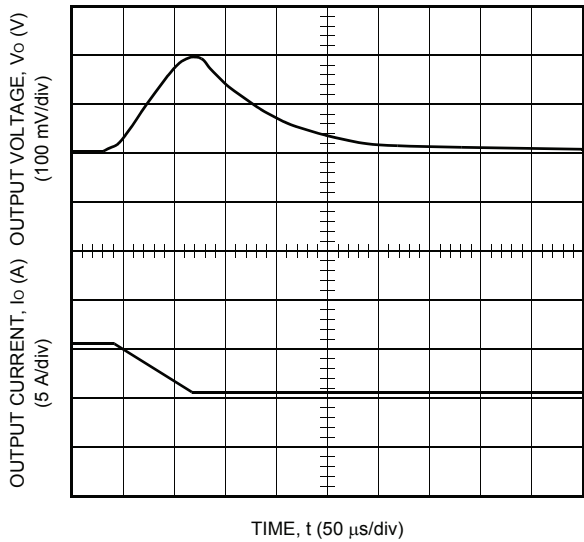

Note: Tested with a 10  $\mu$ F tantalum and a 1.0  $\mu$ F ceramic capacitor across the load.

**Figure 14. Typical JAHW075A Transient Response to Step Decrease in Load from 50% to 25% of  $I_{o, max}$  at Room Temperature and 48 Vdc Input (Waveform Averaged to Eliminate Ripple Component.)**

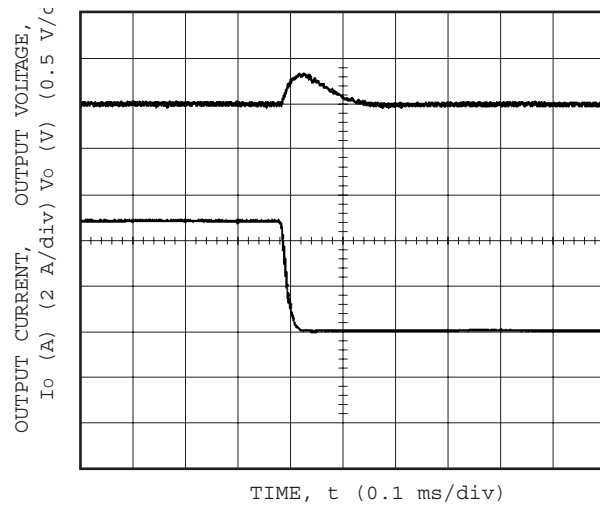

Note: Tested with a 10  $\mu$ F tantalum and a 1.0  $\mu$ F ceramic capacitor across the load.

**Figure 15. Typical JAHW100A Transient Response to Step Decrease in Load from 75% to 50% of  $I_{o, max}$  at Room Temperature and 48 Vdc Input (Waveform Averaged to Eliminate Ripple Component.)**

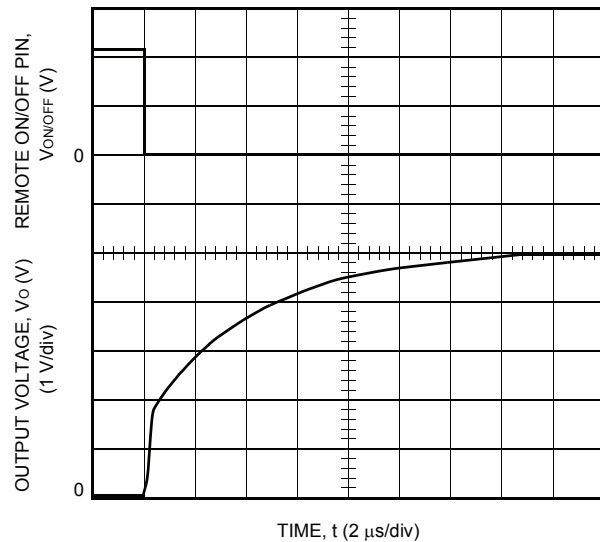

Note: Tested with a 10  $\mu$ F tantalum and a 1.0  $\mu$ F ceramic capacitor across the load.

**Figure 16. Typical Start-Up from Remote On/Off;  $I_o = I_{o, max}$**



### Characteristic Curves (continued)

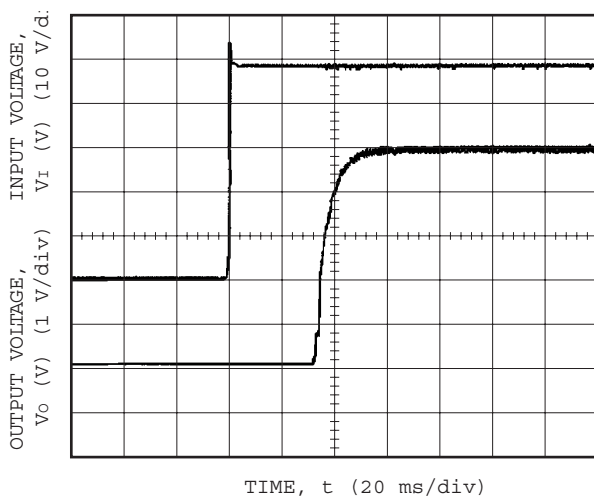

Figure 17. Typical JAHW100A Startup at applied  $V_{IN}$

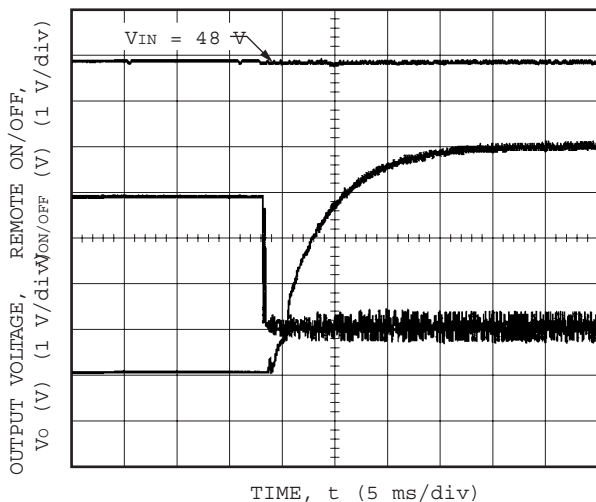
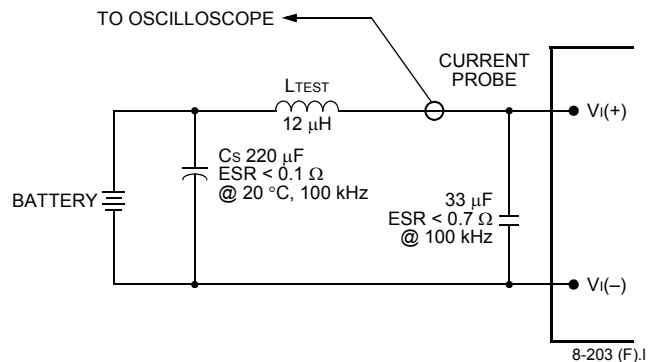

Figure 18. Typical JAHW100A Remote Startup

### Test Configurations



Note: Measure input reflected-ripple current with a simulated source inductance ( $L_{TEST}$ ) of 12  $\mu\text{H}$ . Capacitor  $C_s$  offsets possible battery impedance. Measure current as shown above.

Figure 19. Input Reflected-Ripple Test Setup

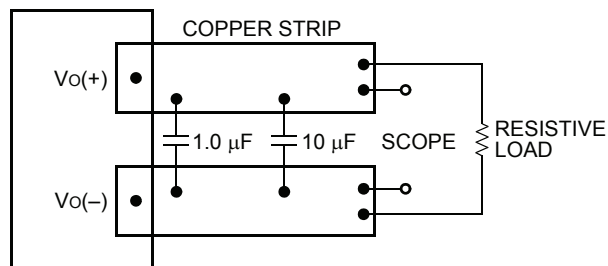

Note: Use a 1.0  $\mu\text{F}$  ceramic capacitor and a 10  $\mu\text{F}$  aluminum or tantalum capacitor. Scope measurement should be made using a BNC socket. Position the load between 51 mm and 76 mm (2 in. and 3 in.) from the module.

Figure 20. Peak-to-Peak Output Noise Measurement Test Setup

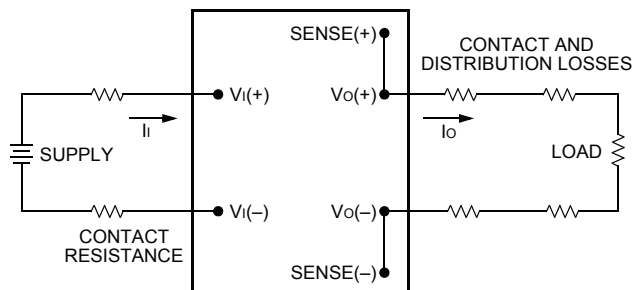

Note: All measurements are taken at the module terminals. When socketing, place Kelvin connections at module terminals to avoid measurement errors due to socket contact resistance.

$$\eta = \left( \frac{[V_o(+)] - [V_o(-)]}{[V_i(+)] - [V_i(-)]} \right) \times 100 \quad \%$$

Figure 21. Output Voltage and Efficiency Measurement Test Setup

## Design Considerations

### Input Source Impedance

The power module should be connected to a low ac-impedance input source. Highly inductive source impedances can affect the stability of the power module. For the test configuration in Figure 19, a 33  $\mu$ F electrolytic capacitor (ESR < 0.7  $\Omega$  at 100 kHz) mounted close to the power module helps ensure stability of the unit. For other highly inductive source impedances, consult the factory for further application guidelines.

### Output Capacitance

High output current transient rate of change (high di/dt) loads may require high values of output capacitance to supply the instantaneous energy requirement to the load. To minimize the output voltage transient drop during this transient, low E.S.R. (equivalent series resistance) capacitors may be required, since a high E.S.R. will produce a correspondingly higher voltage drop during the current transient.

Output capacitance and load impedance interact with the power module's output voltage regulation control system and may produce an 'unstable' output condition for the required values of capacitance and E.S.R.. Minimum and maximum values of output capacitance and of the capacitor's associated E.S.R. may be dictated, depending on the module's control system.

The process of determining the acceptable values of capacitance and E.S.R. is complex and is load-dependant. Lineage provides Web-based tools to assist the power module end-user in appraising and adjusting the effect of various load conditions and output capacitances on specific power modules for various load conditions.

1. Access the web at [www.LineagePower.com](http://www.LineagePower.com)
  2. Under **Products**, click on the **DC-DC** link
  3. Under **Design Tools**, click on **Application Tools Download**
  4. Various design tools will be found, including tools for determining stability of power module systems<sup>§</sup>.
- <sup>§</sup>Not available for all codes, Where not available, use minimum values in table above

## Safety Considerations

For safety-agency approval of the system in which the power module is used, the power module must be installed in compliance with the spacing and separation requirements of the end-use safety agency standard, i.e., UL60950, CSA C22.2 No. 60950-00, and VDE 0805 (IEC60950, IEC950).

If the input source is non-SELV (ELV or a hazardous voltage greater than 60 Vdc and less than or equal to 75 Vdc), for the module's output to be considered meeting the requirements of safety extra-low voltage (SELV), all of the following must be true:

- The input source is to be provided with reinforced insulation from any hazardous voltages, including the ac mains.
- One  $V_I$  pin and one  $V_O$  pin are to be grounded, or both the input and output pins are to be kept floating.
- The input pins of the module are not operator accessible.
- Another SELV reliability test is conducted on the whole system, as required by the safety agencies, on the combination of supply source and the subject module to verify that under a single fault, hazardous voltages do not appear at the module's output.

**Note:** Do not ground either of the input pins of the module without grounding one of the output pins. This may allow a non-SELV voltage to appear between the output pin and ground.

The power module has extra-low voltage (ELV) outputs when all inputs are ELV.

The input to these units is to be provided with a maximum 15 A normal-blow fuse in the ungrounded lead.

## Feature Descriptions

### Overcurrent Protection

To provide protection in an output overload condition, the unit is provided with internal shut down and auto-restart mechanism.

At the instance of current-limit inception, the module enters a "hiccup" mode of operation whereby it shuts down and automatically attempts to restart. As long as the fault persists, the module remains in this mode.

The protection mechanism is such that the unit can continue in this condition for a sufficient interval of time until the fault is cleared.

A latch-off option is also available

## Feature Descriptions (continued)

### Remote On/Off

Two remote on/off options are available. Positive logic remote on/off turns the module on during a logic-high voltage on the ON/OFF pin, and off during a logic low. Negative logic remote on/off turns the module off during a logic high and on during a logic low. Negative logic, device code suffix "1," is the factory-preferred configuration.

To turn the power module on and off, the user must supply a switch to control the voltage between the on/off terminal and the  $V_i(-)$  terminal ( $V_{on/off}$ ). The switch can be an open collector or equivalent (see Figure 22). A logic low is  $V_{on/off} = 0$  V to 1.2 V. The maximum  $I_{on/off}$  during a logic low is 1 mA. The switch should maintain a logic-low voltage while sinking 1 mA.

During a logic high, the maximum  $V_{on/off}$  generated by the power module is 15 V. The maximum allowable leakage current of the switch at  $V_{on/off} = 15$  V is 50  $\mu$ A.

If not using the remote on/off feature, do one of the following to turn the unit on:

- For negative logic, short ON/OFF pin to  $V_i(-)$ .
- For positive logic, leave ON/OFF pin open.

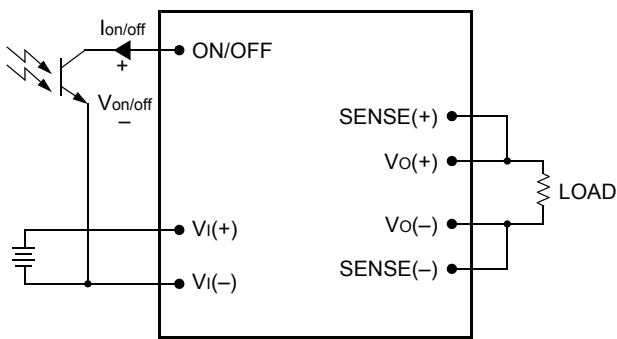

8-720(F).c

Figure 22. Remote On/Off Implementation

### Remote Sense

Remote sense minimizes the effects of distribution losses by regulating the voltage at the remote-sense connections. The voltage between the remote-sense pins and the output terminals must not exceed the output voltage sense range given in the Feature Specifications table, i.e.:

$$[V_o(+)-V_o(-)]-[SENSE(+)-SENSE(-)]\leq 0.5\text{ V}$$

The voltage between the  $V_o(+)$  and  $V_o(-)$  terminals must not exceed the minimum output overvoltage shut-down value indicated in the Feature Specifications table. This limit includes any increase in voltage due to remote-sense compensation and output voltage set-point adjustment (trim).

If not using the remote-sense feature to regulate the output at the point of load, then connect SENSE(+) to  $V_o(+)$  and SENSE(-) to  $V_o(-)$  at the module.

Although the output voltage can be increased by both the remote sense and by the trim, the maximum increase for the output voltage is not the sum of both. The maximum increase is the larger of either the remote sense or the trim. Consult the factory if you need to increase the output voltage more than the above limitation.

The amount of power delivered by the module is defined as the voltage at the output terminals multiplied by the output current. When using remote sense and trim, the output voltage of the module can be increased, which at the same output current would increase the power output of the module. Care should be taken to ensure that the maximum output power of the module remains at or below the maximum rated power.

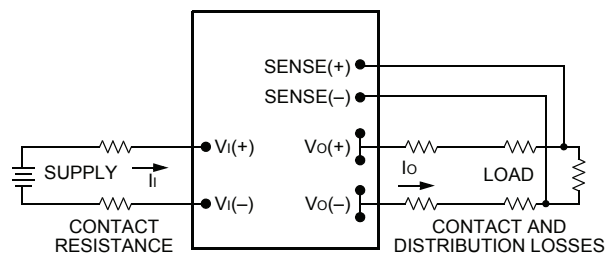

8-651 (F).m

Figure 23. Effective Circuit Configuration for Single-Module Remote-Sense Operation

## Feature Descriptions (continued)

### Output Voltage Set-Point Adjustment (Trim)

Output voltage trim allows the user to increase or decrease the output voltage set point of a module. This is accomplished by connecting an external resistor between the TRIM pin and either the SENSE(+) or SENSE(-) pins. The trim resistor should be positioned close to the module.

If not using the trim feature, leave the TRIM pin open.

With an external resistor between the TRIM and SENSE(-) pins ( $R_{\text{adj-down}}$ ), the output voltage set point ( $V_{O, \text{adj}}$ ) decreases (see Figure 24). The following equation determines the required external-resistor value to obtain a percentage output voltage change of  $\Delta\%$ .

$$R_{\text{adj-down}} = \left( \frac{1000}{\Delta\%} - 11 \right) \text{k}\Omega$$

The test results for this configuration are displayed in Figure 25. This figure applies to all output voltages.

With an external resistor connected between the TRIM and SENSE(+) pins ( $R_{\text{adj-up}}$ ), the output voltage set point ( $V_{O, \text{adj}}$ ) increases (see Figure 26).

The following equation determines the required external-resistor value to obtain a percentage output voltage change of  $\Delta\%$ .

$$R_{\text{adj-up}} = \left( \frac{(V_{O, \text{nom}}) \left( 1 + \frac{\Delta\%}{100} \right) - 1.225}{1.225\Delta\%} 1000 - 11 \right) \text{k}\Omega$$

The voltage between the  $V_{O(+)}$  and  $V_{O(-)}$  terminals must not exceed the minimum output overvoltage shut-down value indicated in the Feature Specifications table. This limit includes any increase in voltage due to remote-sense compensation and output voltage set-point adjustment (trim).

Although the output voltage can be increased by both the remote sense and by the trim, the maximum increase for the output voltage is not the sum of both. The maximum increase is the larger of either the remote sense or the trim. Consult the factory if you need to increase the output voltage more than the above limitation.

The amount of power delivered by the module is defined as the voltage at the output terminals multiplied by the output current. When using remote sense and trim, the output voltage of the module can be increased, which at the same output current would increase the power output of the module. Care should be taken to ensure that the maximum output power of the module remains at or below the maximum rated power.

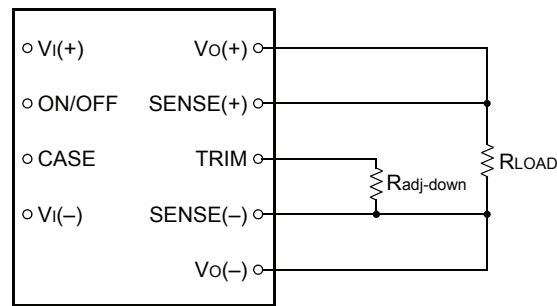

8-748 (F),b

Figure 24. Circuit Configuration to Decrease Output Voltage

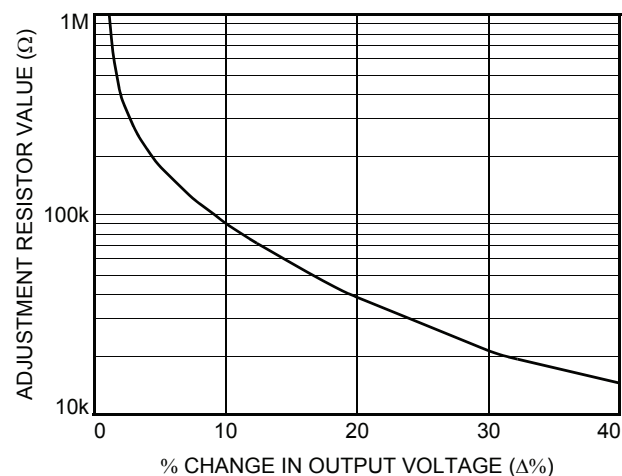

8-3207 (F)

Figure 25. Resistor Selection for Decreased Output Voltage

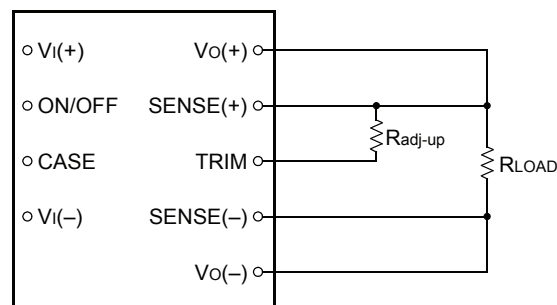

8-715 (F),b

Figure 26. Circuit Configuration to Increase Output Voltage

## Feature Descriptions (continued)

### Output Overvoltage Protection

The output overvoltage protection consists of circuitry that monitors the voltage on the output terminals. If the voltage on the output terminals exceeds the overvoltage protection threshold, then the module will shut down and attempt to restart. A latch-ff option is also available.\*

### Overtemperature Protection

To provide protection in a fault condition, the unit is equipped with an overtemperature circuit. In a event of such a fault, the module enters into an auto-restart "hiccup" mode with low output voltage until the fault is removed. Recovery from the overtemperature protection is automatic after the unit cools below the overtemperature protection threshold. A latch-ff option is also available.\*

\* Protection latch-off causes the output to be disabled until input power is recycled or until the remote on-off is recycled off-on.

## Thermal Considerations

### Introduction

The power modules operate in a variety of thermal environments; however, sufficient cooling should be provided to help ensure reliable operation of the unit. Heat-dissipating components inside the unit are thermally coupled to the case. Heat is removed by conduction, convection, and radiation to the surrounding environment. Proper cooling can be verified by measuring the case temperature. Peak temperature ( $T_c$ ) occurs at the position indicated in Figure 27.

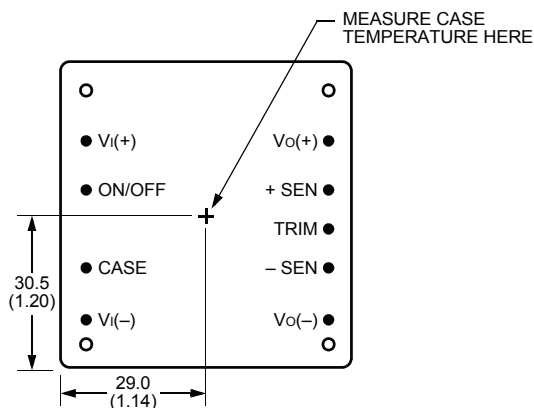

8-716 (F).h

Note: Top view, pin locations are for reference only. Measurements shown in millimeters and (inches).

**Figure 27. Case Temperature Measurement Location**

Lineage Power

The temperature at this location should not exceed 100 °C. The output power of the module should not exceed the rated power for the module as listed in the Ordering Information table.

Although the maximum case temperature of the power modules is 100 °C, you can limit this temperature to a lower value for extremely high reliability.

### Heat Transfer Without Heat Sinks

Increasing airflow over the module enhances the heat transfer via convection. Figure 28 shows the maximum power that can be dissipated by the module without exceeding the maximum case temperature versus local ambient temperature ( $T_A$ ) for natural convection through 4 m/s (800 ft./min.).

Note that the natural convection condition was measured at 0.05 m/s to 0.1 m/s (10 ft./min. to 20 ft./min.); however, systems in which these power modules may be used typically generate natural convection airflow rates of 0.3 m/s (60 ft./min.) due to other heat dissipating components in the system. The use of Figure 28 is shown in the following example.

### Example

What is the minimum airflow necessary for a JAHW075A operating at  $V_i = 55$  V, an output current of 15 A, and a maximum ambient temperature of 55 °C?

### Solution

Given:  $V_i = 55$  V  
 $I_o = 15$  A  
 $T_A = 55$  °C

Determine  $P_D$  (Use Figure 31.):

$$P_D = 8 \text{ W}$$

Determine airflow ( $v$ ) (Use Figure 28.):

$$v = 0.5 \text{ m/s (100 ft./min.)}$$

Thermal Considerations (continued)

Heat Transfer Without Heat Sinks (continued)

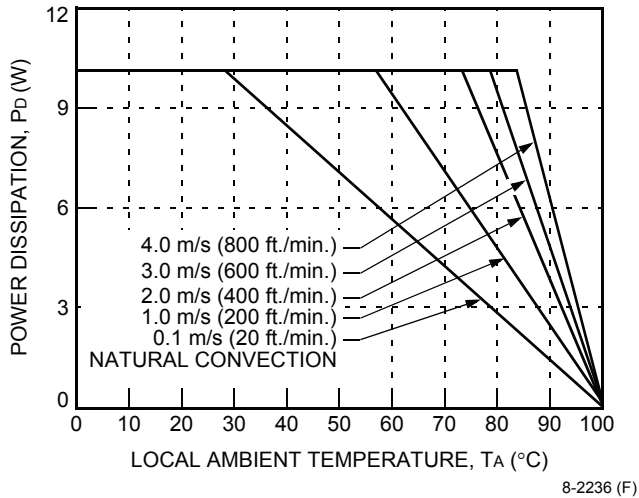

8-2236 (F)

Figure 28. JAHW050A and JAHW075A Forced Convection Power Derating with No Heat Sink; Either Orientation

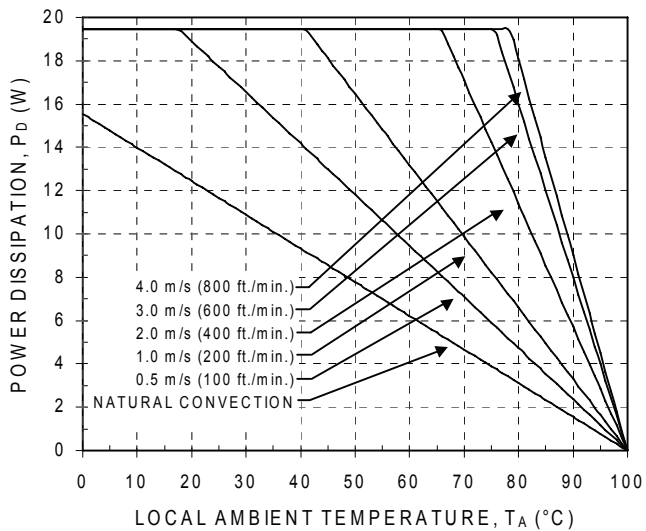

1-0464

Figure 29. JAHW100A Forced Convection Power Derating with No Heat Sink; Either Orientation

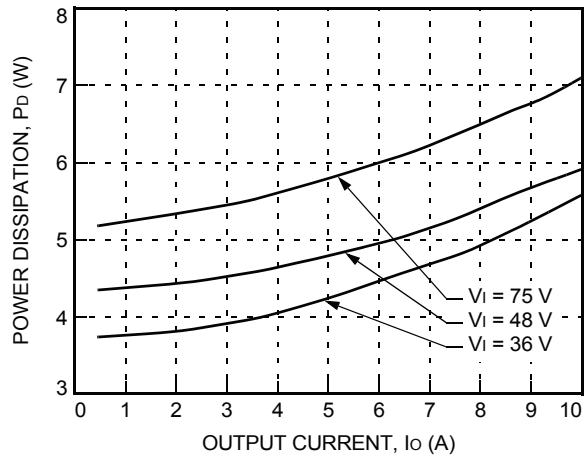

8-2243 (F)

Figure 30. JAHW050A Power Dissipation vs. Output Current at 25 °C

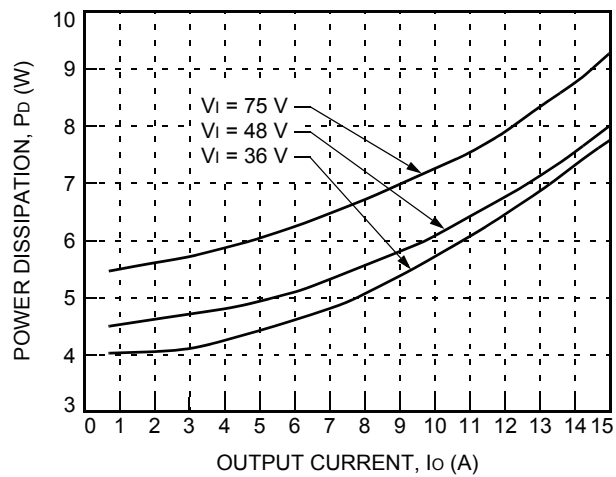

8-2238 (F)

Figure 31. JAHW075A Power Dissipation vs. Output Current at 25 °C



## Thermal Considerations (continued)

### Heat Transfer without Heat Sinks (continued)

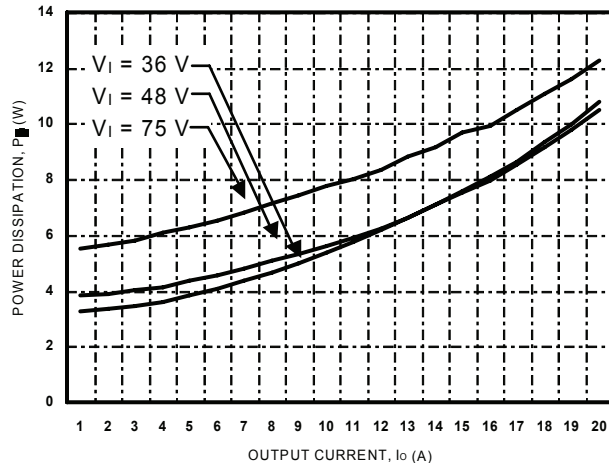

1-0465

**Figure 32. JAHW100A Power Dissipation vs. Output Current at 25 °C**

### Heat Transfer with Heat Sinks

The power modules have through-threaded, M3 x 0.5 mounting holes, which enable heat sinks or cold plates to attach to the module. The mounting torque must not exceed 0.56 N-m (5 in.-lb.).

Thermal derating with heat sinks is expressed by using the overall thermal resistance of the module. Total module thermal resistance ( $\theta_{ca}$ ) is defined as the maximum case temperature rise ( $\Delta T_{C, \max}$ ) divided by the module power dissipation ( $P_D$ ):

$$\theta_{ca} = \left[ \frac{\Delta T_{C, \max}}{P_D} \right] = \left[ \frac{(T_C - T_A)}{P_D} \right]$$

The location to measure case temperature ( $T_C$ ) is shown in Figure 27. Case-to-ambient thermal resistance vs. airflow is shown, for various heat sink configurations and heights, in Figure 33. These curves were obtained by experimental testing of heat sinks, which are offered in the product catalog.

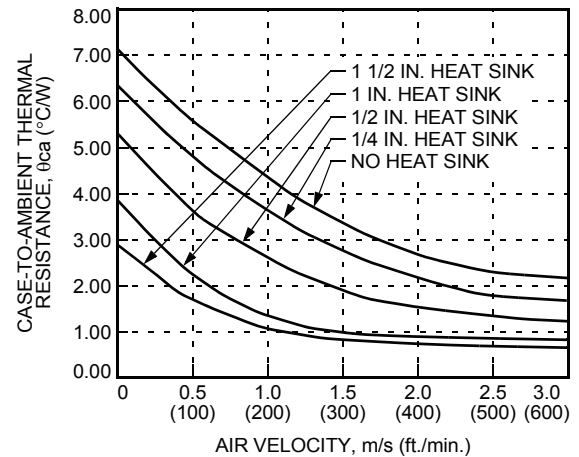

8-2239 (F)

**Figure 33. JAHW050A and JAHW075A Case-to-Ambient Thermal Resistance Curves; Either Orientation**

These measured resistances are from heat transfer from the sides and bottom of the module as well as the top side with the attached heat sink; therefore, the case-to-ambient thermal resistances shown are generally lower than the resistance of the heat sink by itself. The module used to collect the data in Figure 33 had a thermal-conductive dry pad between the case and the heat sink to minimize contact resistance. The use of Figure 33 is shown in the following example.

## Thermal Considerations (continued)

### Heat Transfer with Heat Sinks (continued)

#### Example

If an 85 °C case temperature is desired, what is the minimum airflow necessary? Assume the JAHW075A module is operating at  $V_I = 55$  V and an output current of 15 A, maximum ambient air temperature of 55 °C, and the heat sink is 1/2 inch.

#### Solution

Given:  $V_I = 55$  V  
 $I_O = 15$  A  
 $T_A = 55$  °C  
 $T_C = 85$  °C  
 Heat sink = 1/2 inch

Determine  $P_D$  by using Figure 31:

$$P_D = 8 \text{ W}$$

Then solve the following equation:

$$\theta_{ca} = \left[ \frac{(T_C - T_A)}{P_D} \right]$$

$$\theta_{ca} = \left[ \frac{(85 - 55)}{8} \right]$$

$$\theta_{ca} = 3.8 \text{ °C/W}$$

Use Figure 33 to determine air velocity for the 1/2 inch heat sink.

The minimum airflow necessary for the JAHW075A module is 0.5 m/s (100 ft./min.).

## Custom Heat Sinks

A more detailed model can be used to determine the required thermal resistance of a heat sink to provide necessary cooling. The total module resistance can be separated into a resistance from case-to-sink ( $\theta_{cs}$ ) and sink-to-ambient ( $\theta_{sa}$ ) as shown in Figure 34.

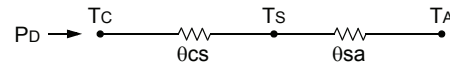

8-1304 (F).e

**Figure 34. Resistance from Case-to-Sink and Sink-to-Ambient**

For a managed interface using thermal grease or foils, a value of  $\theta_{cs} = 0.1$  °C/W to 0.3 °C/W is typical. The solution for heat sink resistance is:

$$\theta_{sa} = \left[ \frac{(T_C - T_A)}{P_D} \right] - \theta_{cs}$$

This equation assumes that all dissipated power must be shed by the heat sink. Depending on the user-defined application environment, a more accurate model, including heat transfer from the sides and bottom of the module, can be used. This equation provides a conservative estimate for such instances.

## EMC Considerations

For assistance with designing for EMC compliance, please refer to the FLTR100V10 data sheet (FDS01-043EPS).

## Layout Considerations

Copper paths must not be routed beneath the power module standoffs. For additional layout guidelines, refer to the FLTR100V10 data sheet (FDS01-043EPS).



## Outline Diagram

Dimensions are in millimeters and (inches).

Tolerances: x.x mm  $\pm$  0.5 mm (x.xx in.  $\pm$  0.02 in.)  
x.xx mm  $\pm$  0.25 mm (x.xxx in.  $\pm$  0.010 in.)

### Top View

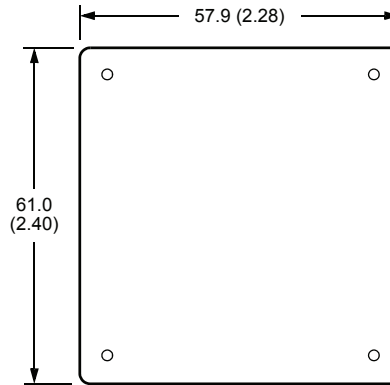

### Side View

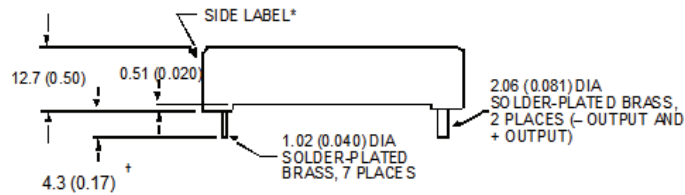

### Bottom View

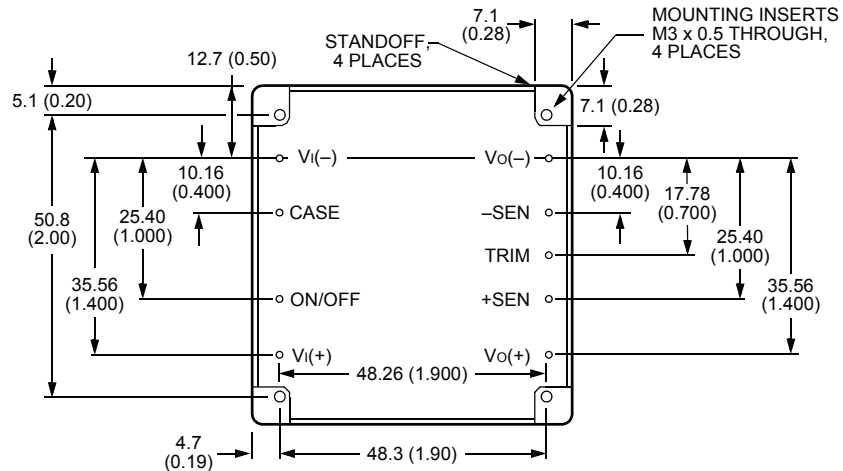

8-716 (F),k

\* Side label includes Lineage name, product designation, safety agency markings, input/output voltage and current ratings, and bar code.

† The case pin may be 1.3(0.05) longer than the other pins.

## Recommended Hole Pattern

Component-side footprint.

Dimensions are in millimeters and (inches).

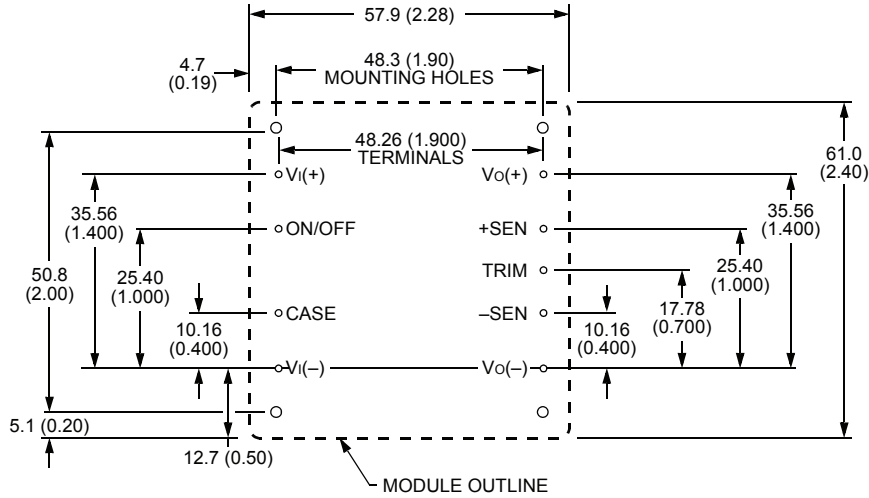

8-716 (F).k

## Ordering Information

Table 4. Device Codes

Input Voltage	Output Voltage	Output Power	Remote On/Off Logic	Device Code	Comcode
48 V	5 V	75 W	Negative	JAHW075A1	108219312
48 V	5 V	75 W	Negative	JAHW075A61	108600610

Optional features can be ordered using the suffixes shown in Table 5. The suffixes follow the last letter of the device code and are placed in descending order. For example, the device codes for a JAHW075A module with the following options are shown below:

Positive logic JAHW075A  
Negative logic JAHW075A1

Table 5. Device Options

Option	Device Code Suffix
Negative remote on/off logic	1
Positive remote on/off logic	—
Latching Protection	5

Note: Legacy device codes may contain a -B option suffix to indicate 100% factory Hi-Pot tested to the isolation voltage specified in the Absolute Maximum Ratings table. The 100% Hi-Pot test is now applied to all device codes, with or without the -B option suffix. Existing comcodes for devices with the -B suffix are still valid; however, no new comcodes for devices containing the -B suffix will be created.



**LINEAGE POWER**

**World Wide Headquarters**

**Lineage Power Corporation**

3000 Skyline Drive, Mesquite, TX 75149, USA

**+1-800-526-7819**

(Outside U.S.A.: **+1-972-284-2626**)

**www.lineagepower.com**

**e-mail: techsupport1@lineagepower.com**

**Asia-Pacific Headquarters**

Tel: +65 6416 4283

**Europe, Middle-East and Africa Headquarters**

Tel: +49 89 6089 286

**India Headquarters**

Tel: +91 80 28411633

---

Lineage Power reserves the right to make changes to the product(s) or information contained herein without notice. No liability is assumed as a result of their use or application. No rights under any patent accompany the sale of any such product(s) or information.

© 2008 Lineage Power Corporation, (Mesquite, Texas) All International Rights Reserved.