

PM50RSK060

FLAT-BASE TYPE
INSULATED PACKAGE

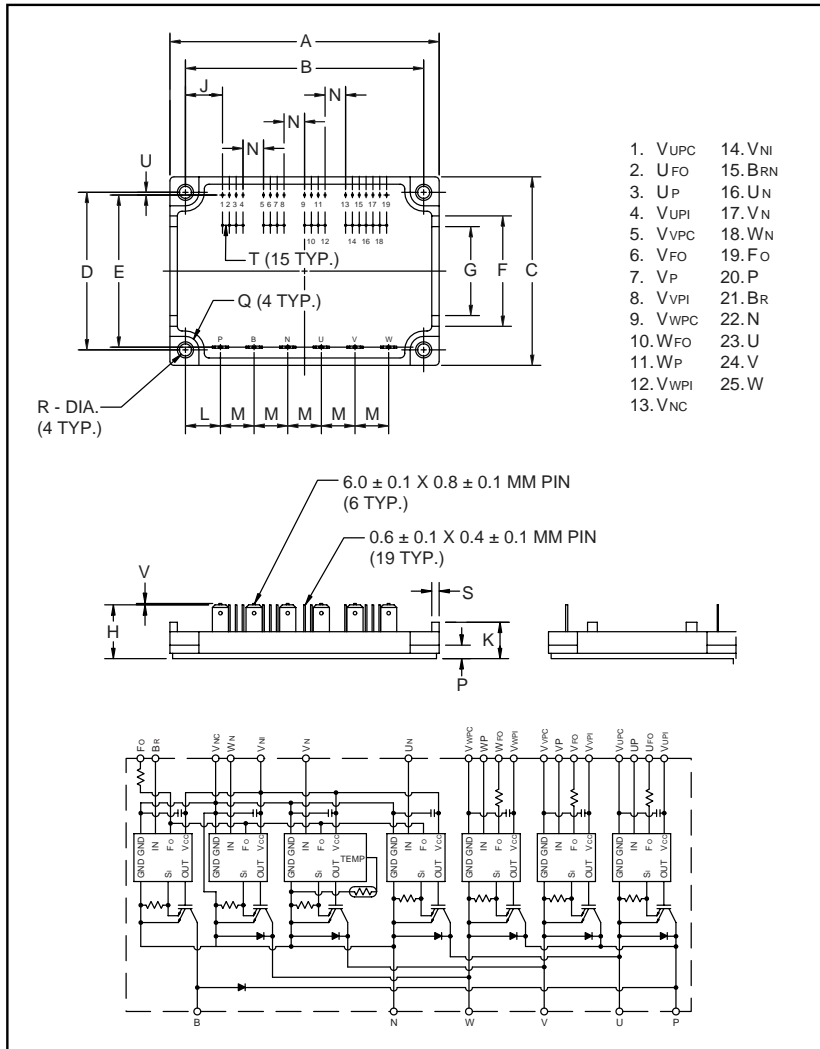

Outline Drawing and Circuit Diagram

Dimensions	Inches	Millimeters
A	3.96±0.04	100.5±1.0
B	3.48±0.02	88.5±0.5
C	2.76±0.04	70.0±1.0
D	2.30±0.02	58.5±0.5
E	2.22±0.02	56.5±0.5
F	1.61	41.0
G	1.30	33.0
H	0.75±0.04	19.0±1.0
J	0.542	13.77
K	0.53	13.5

Dimensions	Inches	Millimeters
L	0.51	13.0
M	0.49±0.01	12.5±0.25
N	0.300±0.01	7.62
P	0.22	5.5
Q	0.20 Rad.	Rad. 5.0
R	0.18 Dia.	Dia. 4.5
S	0.108	2.75
T	0.100±0.01	2.54±0.25
U	0.030	0.75
V	0.04	1.0



Description:

Mitsubishi Intelligent Power Modules are isolated base modules designed for power switching applications operating at frequencies to 20kHz. Built-in control circuits provide optimum gate drive and protection for the IGBT and free-wheel diode power devices.

Features:

- Complete Output Power Circuit
- Gate Drive Circuit
- Protection Logic
 - Short Circuit
 - Over Current
 - Over Temperature
 - Under Voltage

Applications:

- Inverters
- UPS
- Motion/Servo Control
- Power Supplies

Ordering Information:

Example: Select the complete part number from the table below -i.e. PM50RSK060 is a 600V, 50 Ampere Intelligent Power Module.

Type	Current Rating Amperes	V _{CES} Volts (x 10)
PM	50	60

PM50RSK060FLAT-BASE TYPE
INSULATED PACKAGE**Absolute Maximum Ratings, $T_j = 25^\circ\text{C}$ unless otherwise specified**

Ratings	Symbol	PM50RSK060	Units
Power Device Junction Temperature	T_j	-20 to 150	$^\circ\text{C}$
Storage Temperature	T_{stg}	-40 to 125	$^\circ\text{C}$
Case Operating Temperature	T_C	-20 to 100	$^\circ\text{C}$
Mounting Torque, M4 Mounting Screws	—	0.98 ~ 1.47	N · m
Module Weight (Typical)	—	110	Grams
Supply Voltage Protected by OC and SC ($V_D = 13.5 - 16.5\text{V}$, Inverter Part, $T_j = 125^\circ\text{C}$)	$V_{\text{CC(prot.)}}$	400	Volts
Isolation Voltage (Main Terminal to Baseplate, AC 1 min.)	V_{iso}	2500	Vrms

Control Sector

Supply Voltage (Applied between $V_{\text{UP1}}-V_{\text{UPC}}$, $V_{\text{VP1}}-V_{\text{VPC}}$, $V_{\text{WP1}}-V_{\text{WPC}}$, $V_{\text{N1}}-V_{\text{NC}}$)	V_D	20	Volts
Input Voltage (Applied between U_P-V_{UPC} , V_P-V_{VPC} , W_P-V_{WPC} , $U_N \cdot V_N \cdot W_N-V_{\text{NC}}$)	V_{CIN}	20	Volts
Fault Output Supply Voltage (Applied between $U_{\text{FO}}-V_{\text{UPC}}$, $V_{\text{FO}}-V_{\text{VPC}}$, $W_{\text{FO}}-V_{\text{WPC}}$, F_O-V_{NC})	V_{FO}	20	Volts
Fault Output Current (Sink Current of U_{FO} , V_{FO} , W_{FO} and F_O Terminal)	I_{FO}	20	mA

IGBT Inverter Sector

Collector-Emitter Voltage ($V_D = 15\text{V}$, $V_{\text{CIN}} = 15\text{V}$)	V_{CES}	600	Volts
Collector Current, \pm	I_C	50	Amperes
Peak Collector Current, \pm	I_{CP}	100	Amperes
Supply Voltage (Applied between P - N)	V_{CC}	450	Volts
Supply Voltage, Surge (Applied between P - N)	$V_{\text{CC(surge)}}$	500	Volts
Collector Dissipation	P_C	100	Watts

Brake Sector

Collector-Emitter Voltage ($V_D = 15\text{V}$, $V_{\text{CIN}} = 15\text{V}$)	V_{CES}	600	Volts
Collector Current, ($T_C = 25^\circ\text{C}$)	I_C	15	Amperes
Peak Collector Current, ($T_C = 25^\circ\text{C}$)	I_{CP}	30	Amperes
Supply Voltage (Applied between P - N)	V_{CC}	450	Volts
Supply Voltage, Surge (Applied between P - N)	$V_{\text{CC(surge)}}$	500	Volts
Collector Dissipation	P_C	43	Watts
Diode Forward Current	I_F	15	Amperes
Diode DC Reverse Voltage	$V_{\text{R(DC)}}$	600	Volts

PM50RSK060**FLAT-BASE TYPE
INSULATED PACKAGE****Electrical and Mechanical Characteristics, $T_j = 25^\circ\text{C}$ unless otherwise specified**

Characteristics	Symbol	Test Conditions	Min.	Typ.	Max.	Units
Control Sector						
Over Current Trip Level Inverter Part	OC	$-20^\circ\text{C} \leq T \leq 125^\circ\text{C}$, $V_D = 15\text{V}$	65	88	—	Amperes
Over Current Trip Level Brake Part			18	26	—	Amperes
Short Circuit Trip Level Inverter Part	SC	$-20^\circ\text{C} \leq T \leq 125^\circ\text{C}$, $V_D = 15\text{V}$	—	132	—	Amperes
Short Circuit Trip Level Brake Part			—	39	—	Amperes
Over Current Delay Time	$t_{\text{off}}(\text{OC})$	$V_D = 15\text{V}$	—	10	—	μs
Over Temperature Protection	OT	Trip Level	100	110	120	$^\circ\text{C}$
	OT_r	Reset Level	—	90	—	$^\circ\text{C}$
Supply Circuit Under Voltage Protection	UV	Trip Level	11.5	12.0	12.5	Volts
	UV_r	Reset Level	—	12.5	—	Volts
Supply Voltage	V_D	Applied between $V_{\text{UP}1}\text{-}V_{\text{UPC}}$, $V_{\text{VP}1}\text{-}V_{\text{VPC}}$, $V_{\text{WP}1}\text{-}V_{\text{WPC}}$, $V_{\text{N}1}\text{-}V_{\text{NC}}$	13.5	15	16.5	Volts
Circuit Current	I_D	$V_D = 15\text{V}$, $V_{\text{CIN}} = 15\text{V}$, $V_{\text{N}1}\text{-}V_{\text{NC}}$	—	44	60	mA
		$V_D = 15\text{V}$, $V_{\text{CIN}} = 15\text{V}$, $V_{\text{XP}1}\text{-}V_{\text{XPC}}$	—	13	18	mA
Input ON Threshold Voltage	$V_{\text{th}}(\text{on})$	Applied between	1.2	1.5	1.8	Volts
Input OFF Threshold Voltage	$V_{\text{th}}(\text{off})$	$\text{Up}\text{-}V_{\text{UPC}}$, $\text{Vp}\text{-}V_{\text{VPC}}$, $\text{Wp}\text{-}V_{\text{WPC}}$, $\text{UN} \cdot \text{VN} \cdot \text{WN} \cdot \text{Br}\text{-}V_{\text{NC}}$	1.7	2.0	2.3	Volts
PWM Input Frequency	f_{PWM}	3- ϕ Sinusoidal	—	15	20	kHz
Fault Output Current	$I_{\text{FO}}(\text{H})$	$V_D = 15\text{V}$, $V_{\text{FO}} = 15\text{V}$	—	—	0.01	mA
	$I_{\text{FO}}(\text{L})$	$V_D = 15\text{V}$, $V_{\text{FO}} = 15\text{V}$	—	10	15	mA
Minimum Fault Output Pulse Width	t_{FO}	$V_D = 15\text{V}$	1.0	1.8	—	ms

PM50RSK060

**FLAT-BASE TYPE
INSULATED PACKAGE**

Electrical and Mechanical Characteristics, $T_j = 25^\circ\text{C}$ unless otherwise specified

Characteristics	Symbol	Test Conditions	Min.	Typ.	Max.	Units
IGBT Inverter Sector						
Collector Cutoff Current	I_{CES}	$V_{CE} = V_{CES}, T_j = 25^\circ\text{C}$	—	—	1.0	mA
		$V_{CE} = V_{CES}, T_j = 125^\circ\text{C}$	—	—	10	mA
Diode Forward Voltage	V_{EC}	$-I_C = 50\text{A}, V_D = 15\text{V}, V_{CIN} = 15\text{V}$	—	2.2	3.3	Volts
Collector-Emitter Saturation Voltage	$V_{CE(sat)}$	$V_D = 15\text{V}, V_{CIN} = 0\text{V}, I_C = 50\text{A}$	—	1.8	2.7	Volts
		$V_D = 15\text{V}, V_{CIN} = 0\text{V}, I_C = 50\text{A}, T_j = 125^\circ\text{C}$	—	1.85	2.78	Volts
Inductive Load Switching Times	t_{on}		0.4	0.8	2.0	μs
	t_{rr}	$V_D = 15\text{V}, V_{CIN} = 0 \leftrightarrow 15\text{V}$	—	0.15	0.3	μs
	$t_{C(on)}$	$V_{CC} = 300\text{V}, I_C = 50\text{A}$	—	0.4	1.0	μs
	t_{off}	$T_j = 125^\circ\text{C}$	—	2.0	2.9	μs
	$t_{C(off)}$		—	0.5	1.0	μs
Brake Sector						
Collector-Emitter Saturation Voltage	$V_{CE(sat)}$	$V_D = 15\text{V}, V_{CIN} = 0\text{V}, I_C = 15\text{A}, T_j = 25^\circ\text{C}$	—	2.6	3.5	Volts
		$V_D = 15\text{V}, V_{CIN} = 0\text{V}, I_C = 15\text{A}, T_j = 125^\circ\text{C}$	—	3.0	4.0	Volts
Diode Forward Voltage	V_{FM}	$I_F = 15\text{A}, V_D = 15\text{V}, V_{CIN} = 5\text{V}$	—	1.7	2.2	Volts
Collector Cutoff Current	I_{CES}	$V_{CE} = V_{CES}, T_j = 25^\circ\text{C}$	—	—	1	mA
		$V_{CE} = V_{CES}, T_j = 125^\circ\text{C}$	—	—	10	mA

PM50RSK060

**FLAT-BASE TYPE
INSULATED PACKAGE**

Thermal Characteristics

Characteristic	Symbol	Condition	Min.	Typ.	Max.	Units
Junction to Case Thermal Resistance	$R_{th(j-c)Q}$	Each Inverter IGBT	—	—	1.25	°C/Watt
	$R_{th(j-c)F}$	Each Inverter FWDi	—	—	3.0	°C/Watt
	$R_{th(c-f)Q}$	Each Brake IGBT	—	—	2.9	°C/Watt
	$R_{th(c-f)F}$	Each Brake FWDi	—	—	5.4	°C/Watt
Contact Thermal Resistance	$R_{th(c-f)}$	Case to Fin Per Module, Thermal Grease Applied	—	—	0.038	°C/Watt

Recommended Conditions for Use

Characteristic	Symbol	Condition	Value	Units
Supply Voltage	V_{CC}	Applied across P-N Terminals	0 ~ 400	Volts
	V_D	Applied between V_{UP1} - V_{UPC} , V_{N1} - V_{NC} , V_{VP1} - V_{VPC} , V_{WP1} - V_{WPC}	15 ± 1.5	Volts
Input ON Voltage	$V_{CIN(on)}$	Applied between	0 ~ 0.8	Volts
Input OFF Voltage	$V_{CIN(off)}$	U_P - V_{UPC} , V_P - V_{VPC} , W_P - V_{WPC} , U_N · V_N · W_N · B_r - V_{NC}	4.0 ~ V_D	Volts
PWM Input Frequency	f_{PWM}	Using Application Circuit	5 ~ 20	kHz
Minimum Dead Time	t_{dead}	Input Signal	≥ 2.5	μs

PM50RSK060

FLAT-BASE TYPE
INSULATED PACKAGE

Inverter Part

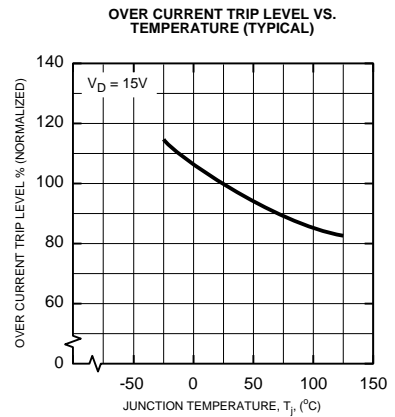
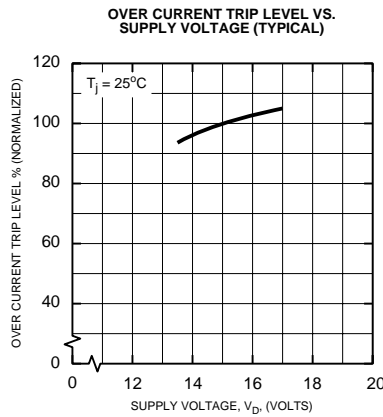
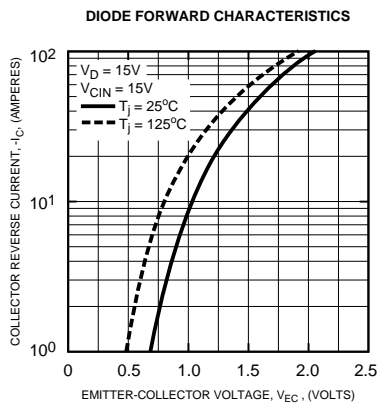
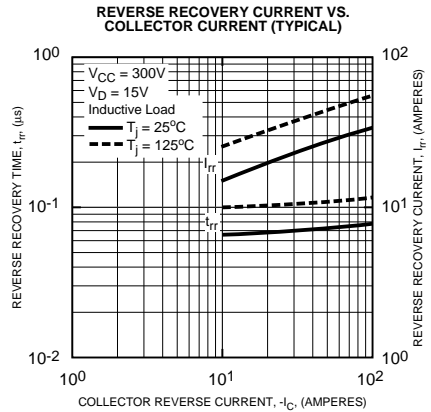
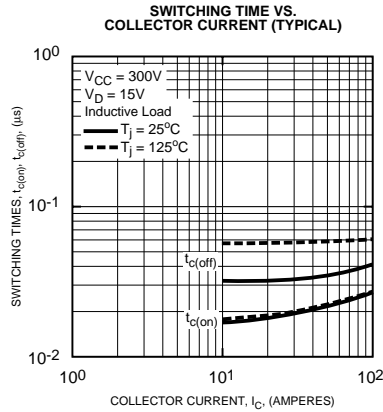
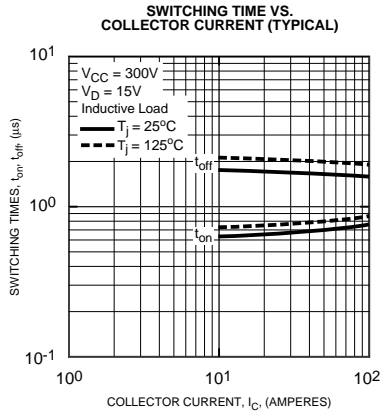
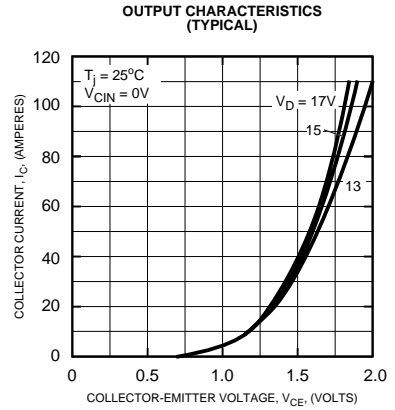
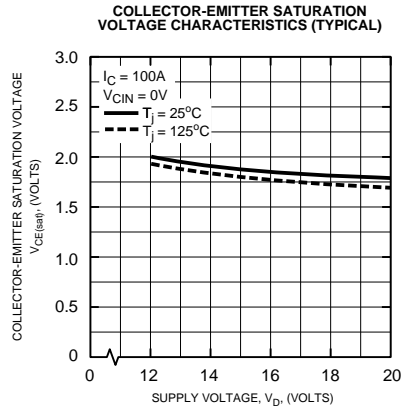
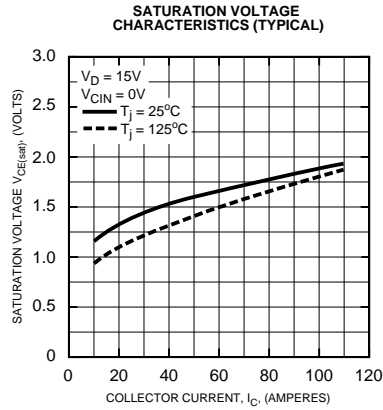

PM50RSK060

FLAT-BASE TYPE
INSULATED PACKAGE

Inverter Part

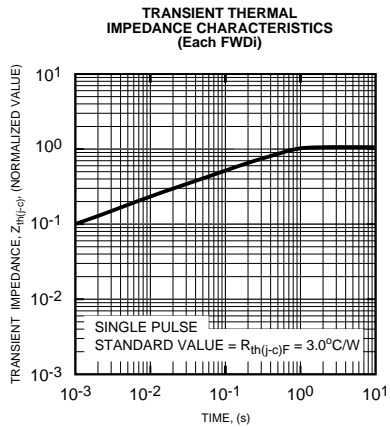
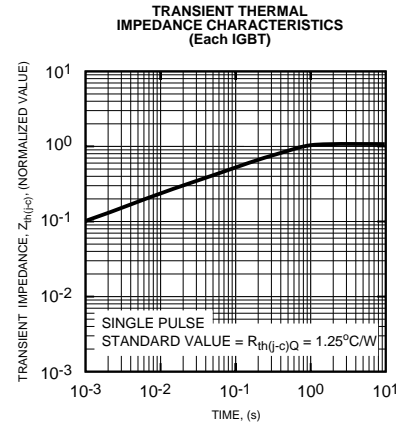
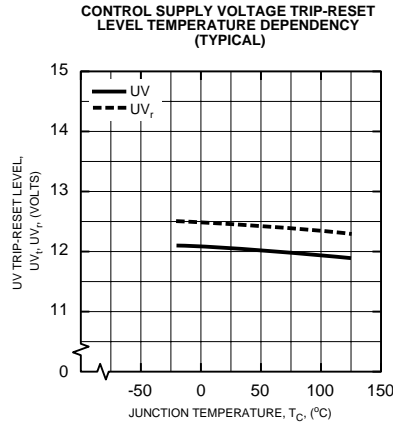
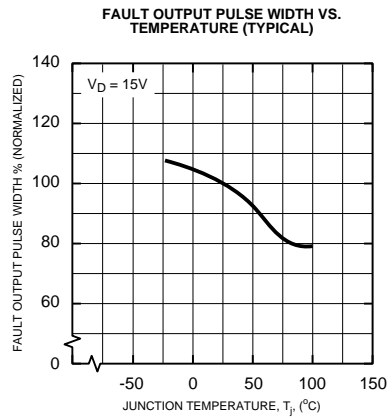

PM50RSK060

FLAT-BASE TYPE
INSULATED PACKAGE

Brake Part

