

MITSUBISHI THYRISTOR MODULES  
**TM25DZ/CZ-M,-H**

MEDIUM POWER GENERAL USE  
 INSULATED TYPE

TM25DZ/CZ-M,-H



- **IT (AV)** Average on-state current ..... **25A**
- **VRRM** Repetitive peak reverse voltage  
 ..... **400/800V**
- **VDRM** Repetitive peak off-state voltage  
 ..... **400/800V**
- **DOUBLE ARMS**
- **Insulated Type**
- **UL Recognized**

Yellow Card No. E80276 (N)  
 File No. E80271

**APPLICATION**

DC motor control, NC equipment, AC motor control, Contactless switches,  
 Electric furnace temperature control, Light dimmers

**OUTLINE DRAWING & CIRCUIT DIAGRAM**

Dimensions in mm

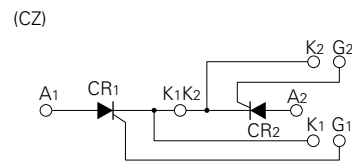
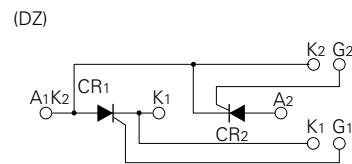
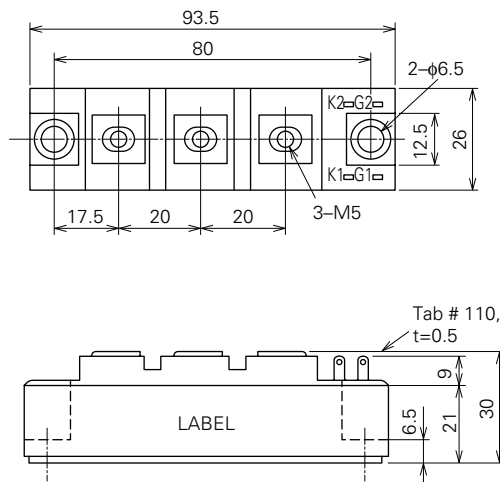

# TM25DZ/CZ-M,-H

MEDIUM POWER GENERAL USE  
INSULATED TYPE

## ABSOLUTE MAXIMUM RATINGS

Symbol	Parameter	Voltage class		Unit
		M	H	
VRRM	Repetitive peak reverse voltage	400	800	V
VRSM	Non-repetitive peak reverse voltage	480	960	V
VR (DC)	DC reverse voltage	320	640	V
VDRM	Repetitive peak off-state voltage	400	800	V
VDSM	Non-repetitive peak off-state voltage	480	960	V
VD (DC)	DC off-state voltage	320	640	V

Symbol	Parameter	Conditions	Ratings	Unit
IT (RMS)	RMS on-state current		39	A
IT (AV)	Average on-state current	Single-phase, half-wave 180° conduction, Tc=93°C	25	A
ITSM	Surge (non-repetitive) on-state current	One half cycle at 60Hz, peak value	500	A
I <sup>2</sup> t	I <sup>2</sup> t for fusing	Value for one cycle of surge current	1.0 × 10 <sup>3</sup>	A <sup>2</sup> s
di/dt	Critical rate of rise of on-state current	VD=1/2VDRM, IG=0.5A, Tj=125°C	100	A/μs
PGM	Peak gate power dissipation		5.0	W
PG (AV)	Average gate power dissipation		0.5	W
VFGM	Peak gate forward voltage		10	V
VRGM	Peak gate reverse voltage		5.0	V
IFGM	Peak gate forward current		2.0	A
Tj	Junction temperature		-40~+125	°C
Tstg	Storage temperature		-40~+125	°C
Viso	Isolation voltage	Charged part to case	2500	V
—	Mounting torque	Main terminal screw M5	1.47~1.96	N·m
			15~20	kg·cm
		Mounting screw M6	1.96~2.94	N·m
			20~30	kg·cm
—	Weight	Typical value	160	g

## ELECTRICAL CHARACTERISTICS

Symbol	Parameter	Test conditions	Limits			Unit
			Min.	Typ.	Max.	
IRRM	Repetitive peak reverse current	Tj=125°C, VRRM applied	—	—	4.0	mA
IDRM	Repetitive peak off-state current	Tj=125°C, VDRM applied	—	—	4.0	mA
VTM	On-state voltage	Tj=125°C, ITM=75A, instantaneous value	—	—	1.5	V
dv/dt	Critical rate of rise of off-state voltage	Tj=125°C, VD=2/3VDRM	500	—	—	V/μs
VGT	Gate trigger voltage	Tj=25°C, VD=6V, RL=2Ω	—	—	3.0	V
VGD	Gate non-trigger voltage	Tj=125°C, VD=1/2VDRM	0.25	—	—	V
IGT	Gate trigger current	Tj=25°C, VD=6V, RL=2Ω	10	—	50	mA
Rth (j-c)	Thermal resistance	Junction to case (per 1/2 module)	—	—	0.8	°C/W
Rth (c-f)	Contact thermal resistance	Case to fin, conductive grease applied (per 1/2 module)	—	—	0.2	°C/W
—	Insulation resistance	Measured with a 500V megohmmeter between main terminal and case	10	—	—	MΩ

# TM25DZ/CZ-M,-H

MEDIUM POWER GENERAL USE  
INSULATED TYPE

## PERFORMANCE CURVES

**MAXIMUM ON-STATE CHARACTERISTIC**

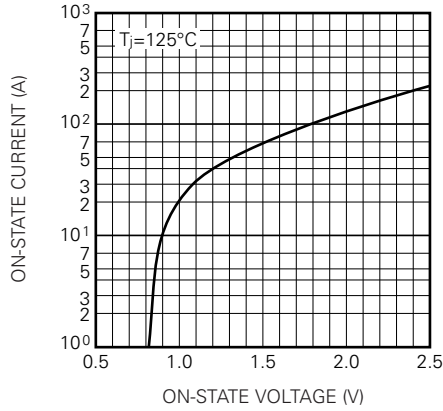

**RATED SURGE (NON-REPETITIVE) ON-STATE CURRENT**

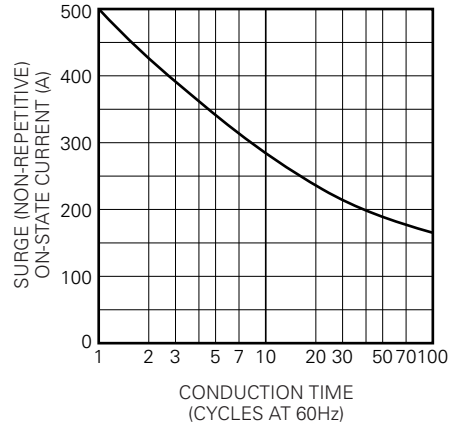

**GATE CHARACTERISTICS**

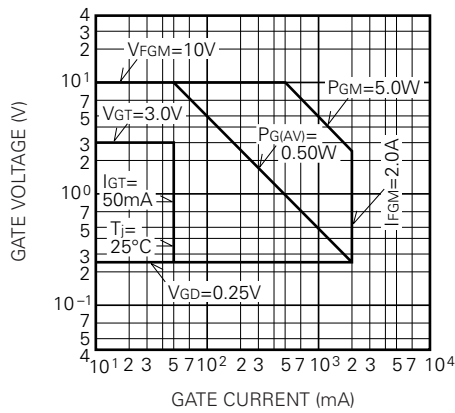

**MAXIMUM TRANSIENT THERMAL IMPEDANCE (JUNCTION TO CASE)**

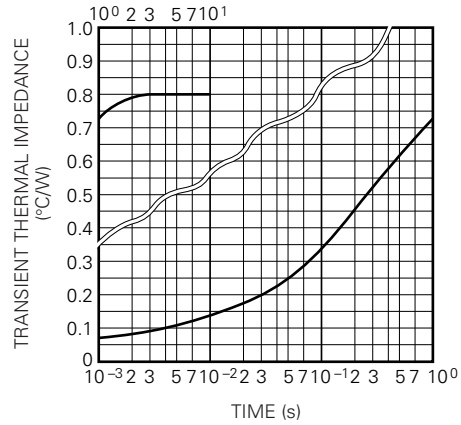

**MAXIMUM AVERAGE ON-STATE POWER DISSIPATION (SINGLE PHASE HALFWAVE)**

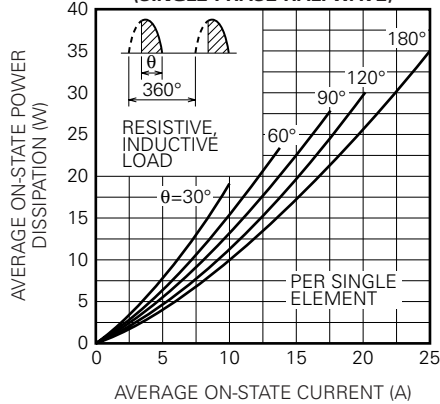

**LIMITING VALUE OF THE AVERAGE ON-STATE CURRENT (SINGLE PHASE HALFWAVE)**

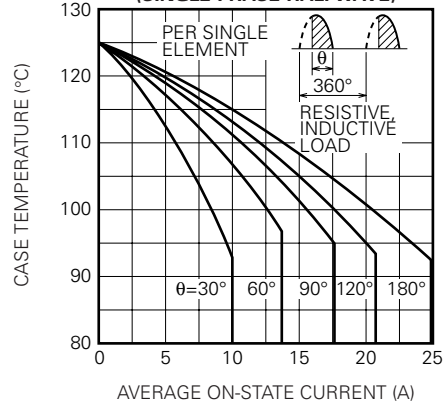

TM25DZ/CZ-M,-H

MEDIUM POWER GENERAL USE  
INSULATED TYPE

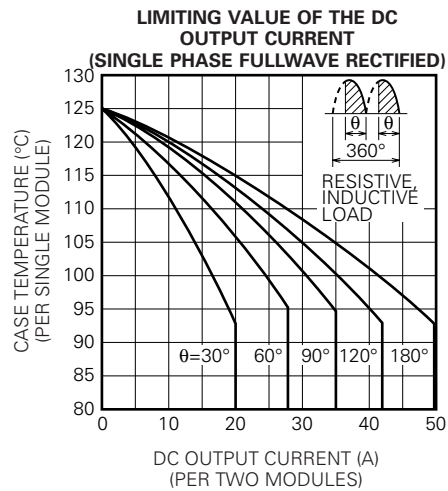
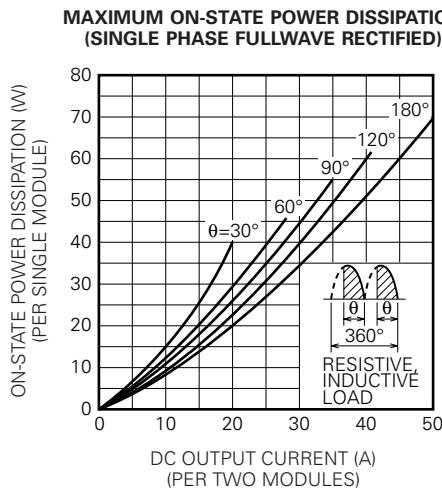
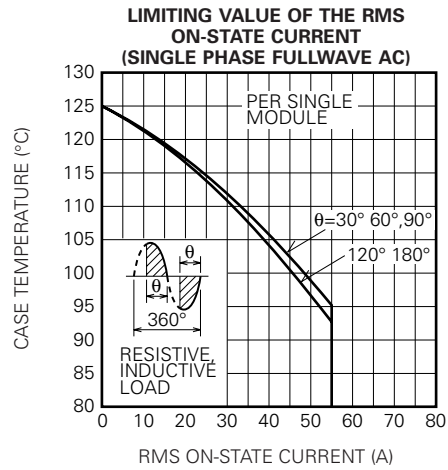
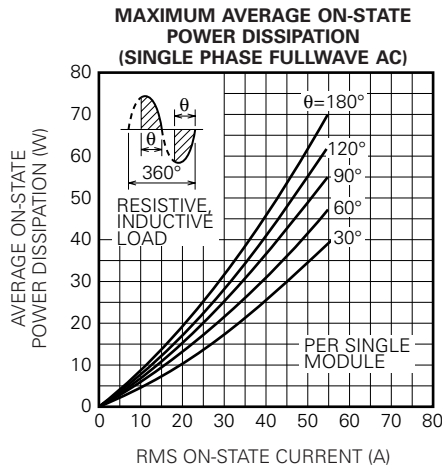
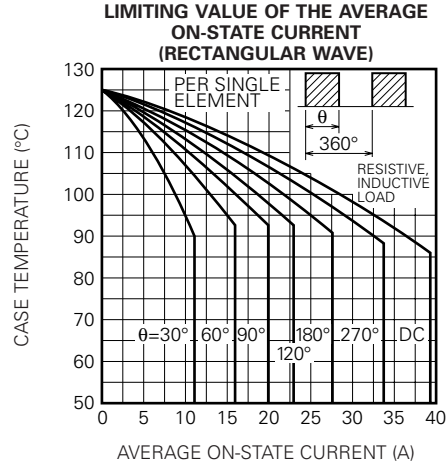
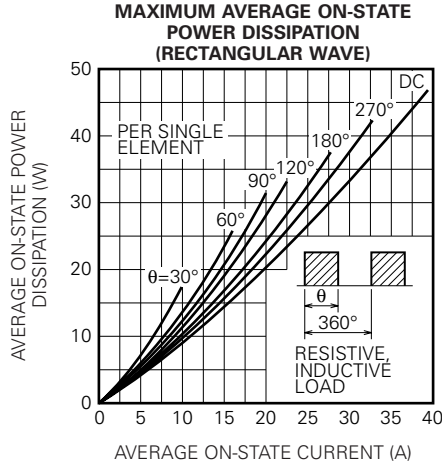

# TM25DZ/CZ-M,-H

MEDIUM POWER GENERAL USE  
INSULATED TYPE

**MAXIMUM ON-STATE POWER DISSIPATION  
(THREE PHASE FULLWAVE RECTIFIED)**

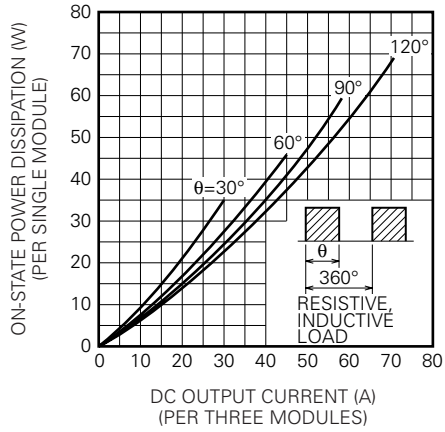

**LIMITING VALUE OF THE DC  
OUTPUT CURRENT  
(THREE PHASE FULLWAVE RECTIFIED)**

