

# QM75CY-H

HIGH POWER SWITCHING USE  
INSULATED TYPE

## QM75CY-H



- **I<sub>C</sub>** Collector current ..... **75A**
- **V<sub>CEX</sub>** Collector-emitter voltage ..... **600V**
- **h<sub>FE</sub>** DC current gain ..... **75**
- **Insulated Type**
- **UL Recognized**

Yellow Card No. E80276 (N)  
File No. E80271

## APPLICATION

UPS, CVCF

## OUTLINE DRAWING & CIRCUIT DIAGRAM

Dimensions in mm

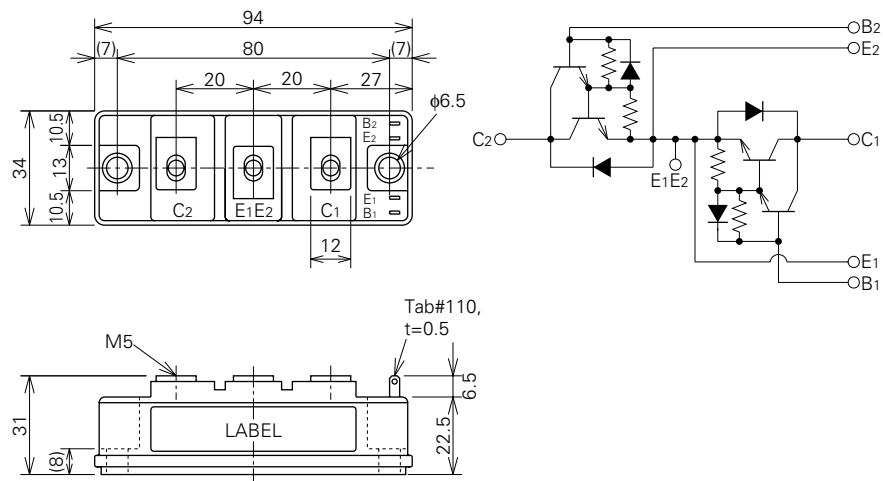

# QM75CY-H

HIGH POWER SWITCHING USE  
INSULATED TYPE

## ABSOLUTE MAXIMUM RATINGS (Tj=25°C, unless otherwise noted)

| Symbol                 | Parameter   | Conditions                                  | Ratings   | Unit  |
|------------------------|---|---|-----------|-------|
| V <sub>CEX (SUS)</sub> | Collector-emitter voltage                               | I <sub>c</sub> =1A, V <sub>EB</sub> =2V     | 600       | V     |
| V <sub>CEX</sub>       | Collector-emitter voltage                               | V <sub>EB</sub> =2V                         | 600       | V     |
| V <sub>CBO</sub>       | Collector-base voltage                                  | Emitter open                                | 600       | V     |
| V <sub>EBO</sub>       | Emitter-base voltage                                    | Collector open                              | 7         | V     |
| I <sub>c</sub>         | Collector current                                       | DC  | 75        | A     |
| -I <sub>c</sub>        | Collector reverse current                               | DC (forward diode current)                  | 75        | A     |
| P <sub>c</sub>         | Collector dissipation                                   | T <sub>c</sub> =25°C                        | 350       | W     |
| I <sub>B</sub>         | Base current  | DC  | 4.5       | A     |
| -I <sub>CSM</sub>      | Surge collector reverse current (forward diode current) | Peak value of one cycle of 60Hz (half wave) | 750       | A     |
| T <sub>J</sub>         | Junction temperature                                    |   | -40~+150  | °C    |
| T <sub>stg</sub>       | Storage temperature                                     |   | -40~+125  | °C    |
| V <sub>iso</sub>       | Isolation voltage                                       | Charged part to case, AC for 1 minute       | 2500      | V     |
| —                      | Mounting torque   | Main terminal screw M5                      | 1.47~1.96 | N·m   |
|                        |   |   | 15~20     | kg·cm |
|                        |   | Mounting screw M6                           | 1.96~2.94 | N·m   |
|                        |   |   | 20~30     | kg·cm |
| —                      | Weight  | Typical value                               | 210       | g     |

## ELECTRICAL CHARACTERISTICS (Tj=25°C, unless otherwise noted)

| Symbol                  | Parameter                                | Test conditions   | Limits |      |      | Unit |
|-------------------------|--|---|--------|------|------|------|
|                         |  |   | Min.   | Typ. | Max. |      |
| I <sub>CEX</sub>        | Collector cutoff current                 | V <sub>CE</sub> =600V, V <sub>EB</sub> =2V  | —      | —    | 1.0  | mA   |
| I <sub>CBO</sub>        | Collector cutoff current                 | V <sub>CB</sub> =600V, Emitter open   | —      | —    | 1.0  | mA   |
| I <sub>EBO</sub>        | Emitter cutoff current                   | V <sub>EB</sub> =7V   | —      | —    | 75   | mA   |
| V <sub>CE (sat)</sub>   | Collector-emitter saturation voltage     | I <sub>c</sub> =75A, I <sub>B</sub> =1A   | —      | —    | 2.0  | V    |
| V <sub>BE (sat)</sub>   | Base-emitter saturation voltage          |   | —      | —    | 2.5  | V    |
| -V <sub>CEO</sub>       | Collector-emitter reverse voltage        | -I <sub>c</sub> =75A (diode forward voltage)  | —      | —    | 1.85 | V    |
| h <sub>FE</sub>         | DC current gain                          | I <sub>c</sub> =50A, V <sub>CE</sub> =2V/5V   | 75/100 | —    | —    | —    |
| t <sub>on</sub>         | Switching time                           | V <sub>CC</sub> =300V, I <sub>c</sub> =75A, I <sub>B1</sub> =-I <sub>B2</sub> =1.5A | —      | —    | 2.5  | μs   |
| t <sub>s</sub>          |  |   | —      | —    | 15   | μs   |
| t <sub>f</sub>          |  |   | —      | —    | 3.0  | μs   |
| R <sub>th (j-c) Q</sub> | Thermal resistance (junction to case)    | Transistor part (per 1/2 module)  | —      | —    | 0.35 | °C/W |
| R <sub>th (j-c) R</sub> | Thermal resistance (junction to case)    | Diode part (per 1/2 module)   | —      | —    | 1.3  | °C/W |
| R <sub>th (c-f)</sub>   | Contact thermal resistance (case to fin) | Conductive grease applied (per 1/2 module)  | —      | —    | 0.15 | °C/W |

# QM75CY-H

HIGH POWER SWITCHING USE  
INSULATED TYPE

## PERFORMANCE CURVES

**COMMON EMITTER OUTPUT CHARACTERISTICS (TYPICAL)**

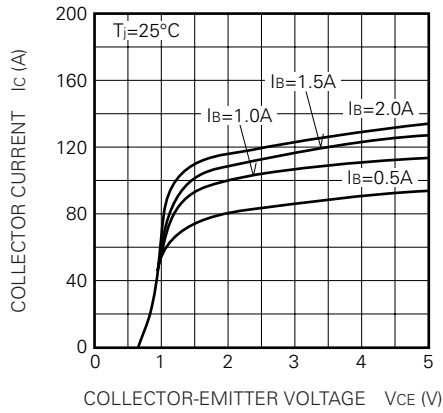

**DC CURRENT GAIN VS. COLLECTOR CURRENT (TYPICAL)**

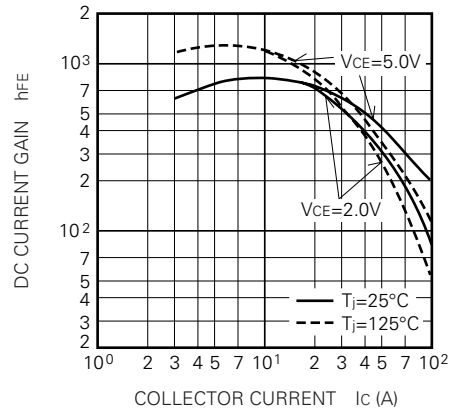

**COMMON EMITTER INPUT CHARACTERISTIC (TYPICAL)**

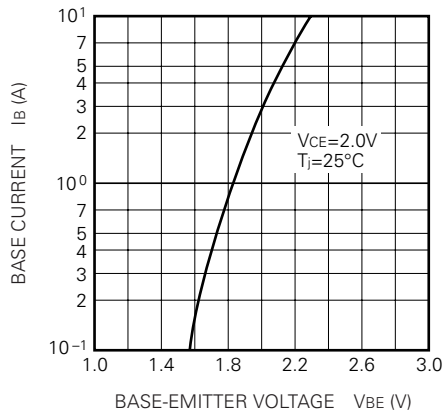

**SATURATION VOLTAGE CHARACTERISTICS (TYPICAL)**

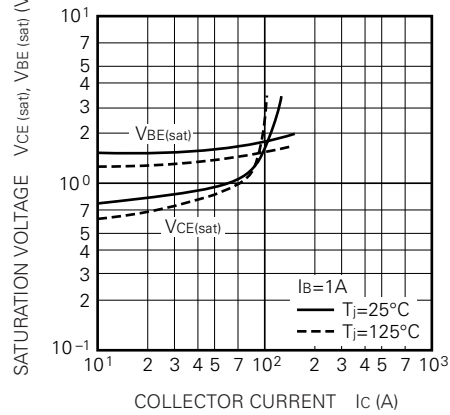

**COLLECTOR-EMITTER SATURATION VOLTAGE (TYPICAL)**

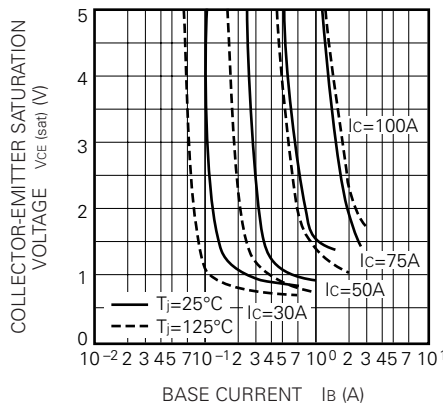

**SWITCHING TIME VS. COLLECTOR CURRENT (TYPICAL)**

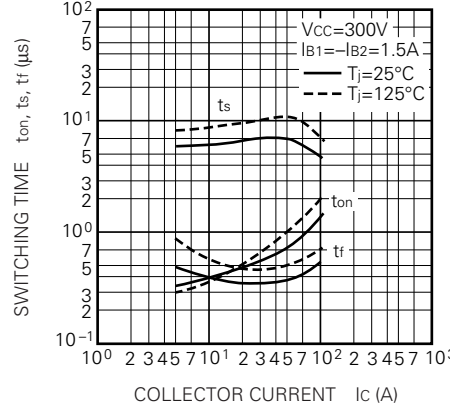

# QM75CY-H

HIGH POWER SWITCHING USE  
INSULATED TYPE

**SWITCHING TIME VS. BASE CURRENT (TYPICAL)**

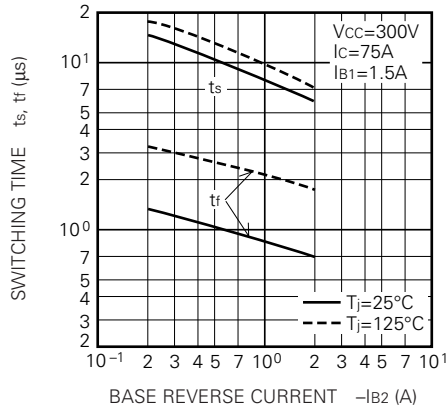

**REVERSE BIAS SAFE OPERATING AREA**

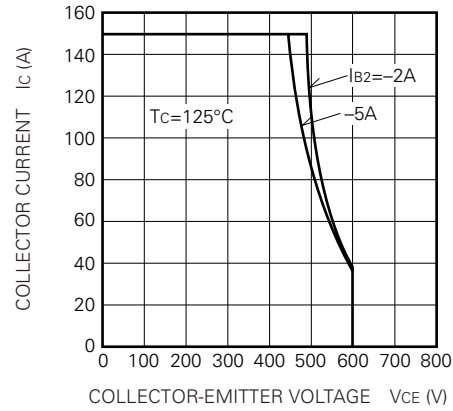

**FORWARD BIAS SAFE OPERATING AREA**

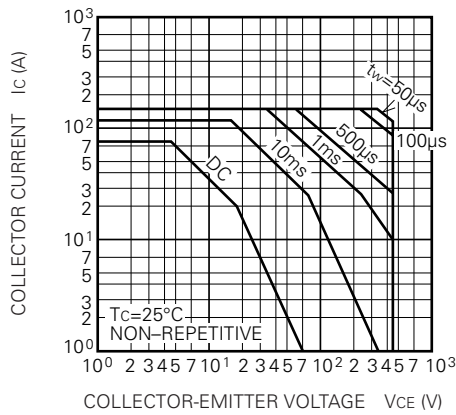

**DERATING FACTOR OF F. B. S. O. A.**

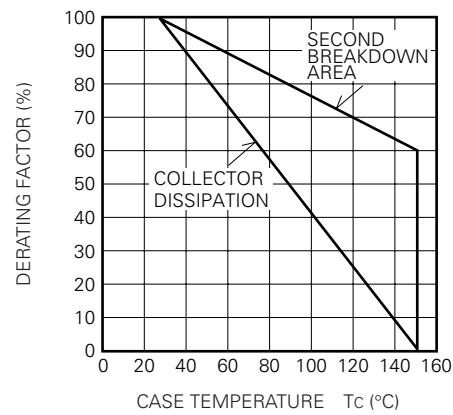

**TRANSIENT THERMAL IMPEDANCE CHARACTERISTIC (TRANSISTOR)**

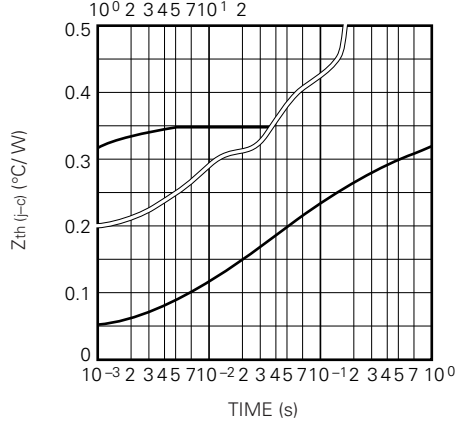

**REVERSE COLLECTOR CURRENT VS. COLLECTOR-EMITTER REVERSE VOLTAGE (DIODE FORWARD CHARACTERISTICS) (TYPICAL)**

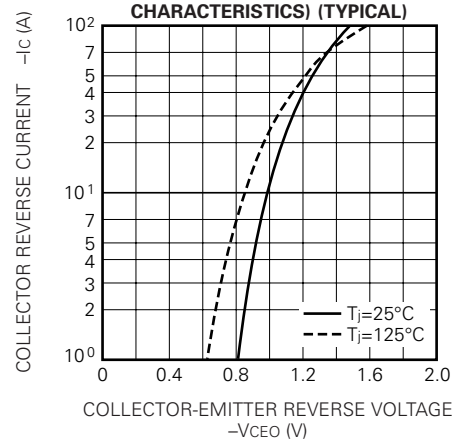

# QM75CY-H

HIGH POWER SWITCHING USE  
INSULATED TYPE

**RATED SURGE COLLECTOR REVERSE CURRENT  
(DIODE FORWARD SURGE CURRENT)**

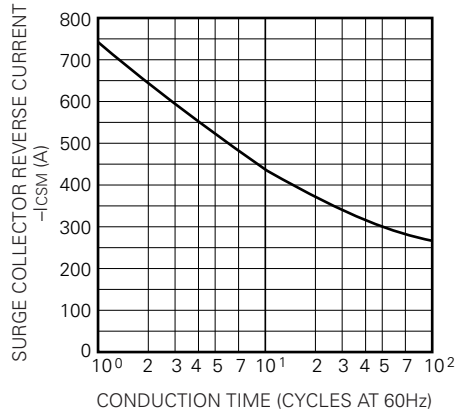

**REVERSE RECOVERY CHARACTERISTICS  
OF FREE-WHEEL DIODE (TYPICAL)**

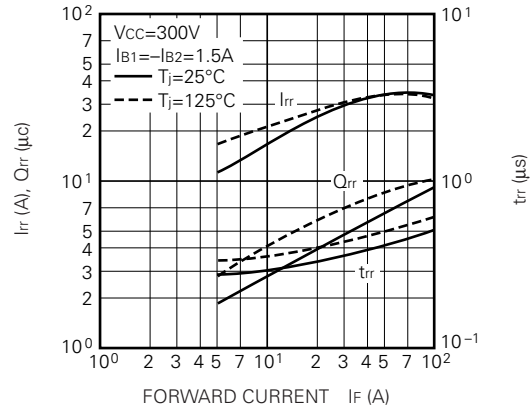

**TRANSIENT THERMAL IMPEDANCE  
CHARACTERISTIC (DIODE)**

