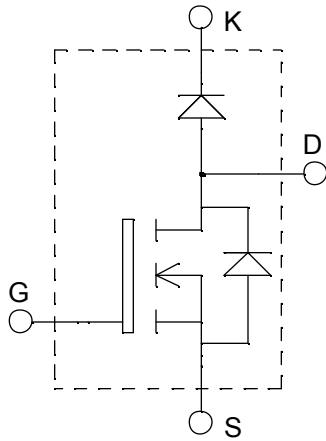

**ISOTOP[®] Boost chopper
MOSFET Power Module**

$V_{DSS} = 500V$
 $R_{DSon} = 100m\Omega \text{ max @ } T_j = 25^\circ C$
 $I_D = 44A \text{ @ } T_c = 25^\circ C$

Application

- AC and DC motor control
- Switched Mode Power Supplies
- Power Factor Correction
- Brake switch

Features

- Power MOS V[®] MOSFETs
 - Low R_{DSon}
 - Low input and Miller capacitance
 - Low gate charge
 - Fast intrinsic diode
 - Avalanche energy rated
 - Very rugged
- ISOTOP[®] Package (SOT-227)
- Very low stray inductance
- High level of integration

Benefits

- Outstanding performance at high frequency operation
- Direct mounting to heatsink (isolated package)
- Low junction to case thermal resistance
- Very rugged
- Low profile
- RoHS Compliant

Absolute maximum ratings

Symbol	Parameter	Max ratings	Unit
V_{DSS}	Drain - Source Breakdown Voltage	500	V
I_D	Continuous Drain Current	$T_c = 25^\circ C$	44
		$T_c = 80^\circ C$	33
I_{DM}	Pulsed Drain current	176	A
V_{GS}	Gate - Source Voltage	± 30	V
R_{DSon}	Drain - Source ON Resistance	100	$m\Omega$
P_D	Maximum Power Dissipation	$T_c = 25^\circ C$	450
I_{AR}	Avalanche current (repetitive and non repetitive)	44	A
E_{AR}	Repetitive Avalanche Energy	50	mJ
E_{AS}	Single Pulse Avalanche Energy	2500	
I_{FAV}	Maximum Average Forward Current	Duty cycle=0.5	A
I_{FRMS}	RMS Forward Current (Square wave, 50% duty)	$T_c = 80^\circ C$	
			39

CAUTION: These Devices are sensitive to Electrostatic Discharge. Proper Handling Procedures Should Be Followed.

All ratings @ $T_j = 25^\circ\text{C}$ unless otherwise specified

Electrical Characteristics

Symbol	Characteristic	Test Conditions		Min	Typ	Max	Unit
I_{DSS}	Zero Gate Voltage Drain Current	$V_{GS} = 0\text{V}, V_{DS} = 500\text{V}$	$T_j = 25^\circ\text{C}$			25	μA
		$V_{GS} = 0\text{V}, V_{DS} = 400\text{V}$	$T_j = 125^\circ\text{C}$			250	
$R_{DS(on)}$	Drain – Source on Resistance	$V_{GS} = 10\text{V}, I_D = 22\text{A}$				100	$\text{m}\Omega$
$V_{GS(th)}$	Gate Threshold Voltage	$V_{GS} = V_{DS}, I_D = 2.5\text{mA}$		2		4	V
I_{GSS}	Gate – Source Leakage Current	$V_{GS} = \pm 20\text{V}, V_{DS} = 0\text{V}$				± 100	nA

Dynamic Characteristics

Symbol	Characteristic	Test Conditions		Min	Typ	Max	Unit
C_{iss}	Input Capacitance	$V_{GS} = 0\text{V}$			7410		pF
C_{oss}	Output Capacitance	$V_{DS} = 25\text{V}$			1050		
C_{rss}	Reverse Transfer Capacitance	$f = 1\text{MHz}$			390		
Q_g	Total gate Charge	$V_{GS} = 10\text{V}$			312		nC
Q_{gs}	Gate – Source Charge	$V_{Bus} = 250\text{V}$			37		
Q_{gd}	Gate – Drain Charge	$I_D = 44\text{A} @ T_j = 25^\circ\text{C}$			127		
$T_{d(on)}$	Turn-on Delay Time	$V_{GS} = 15\text{V}$			18		ns
T_r	Rise Time	$V_{Bus} = 250\text{V}$			16		
$T_{d(off)}$	Turn-off Delay Time	$I_D = 44\text{A} @ T_j = 25^\circ\text{C}$			54		
T_f	Fall Time	$R_G = 0.6\Omega$			5		

Chopper diode ratings and characteristics

Symbol	Characteristic	Test Conditions		Min	Typ	Max	Unit
V_F	Diode Forward Voltage	$I_F = 30\text{A}$			1.6	1.8	V
		$I_F = 60\text{A}$			1.9		
		$I_F = 30\text{A}$	$T_j = 125^\circ\text{C}$		1.4		
I_{RM}	Maximum Reverse Leakage Current	$V_R = 600\text{V}, T_j = 25^\circ\text{C}$				250	μA
		$V_R = 600\text{V}, T_j = 125^\circ\text{C}$				500	
C_T	Junction Capacitance	$V_R = 200\text{V}$			44		pF
t_{rr}	Reverse Recovery Time	$I_F = 1\text{A}, V_R = 30\text{V}$ $di/dt = 100\text{A}/\mu\text{s}$		$T_j = 25^\circ\text{C}$	23		ns
	Reverse Recovery Time			$T_j = 25^\circ\text{C}$	85		
				$T_j = 125^\circ\text{C}$	160		
I_{RRM}	Maximum Reverse Recovery Current	$I_F = 30\text{A}$ $V_R = 400\text{V}$ $di/dt = 200\text{A}/\mu\text{s}$		$T_j = 25^\circ\text{C}$	4		A
				$T_j = 125^\circ\text{C}$	8		
				$T_j = 25^\circ\text{C}$	130		
Q_{rr}	Reverse Recovery Charge			$T_j = 25^\circ\text{C}$	700		nC
				$T_j = 125^\circ\text{C}$			
t_{rr}	Reverse Recovery Time	$I_F = 30\text{A}$		$T_j = 125^\circ\text{C}$	70		ns
Q_{rr}	Reverse Recovery Charge	$V_R = 400\text{V}$			1300		nC
I_{RRM}	Maximum Reverse Recovery Current	$di/dt = 1000\text{A}/\mu\text{s}$			30		A

Thermal and package characteristics

Symbol	Characteristic	Min	Typ	Max	Unit
R_{thJC}	Junction to Case Thermal Resistance	MOSFET		0.28	°C/W
		Diode		1.21	
R_{thJA}	Junction to Ambient (IGBT & Diode)			20	
V_{ISOL}	RMS Isolation Voltage, any terminal to case $t=1$ min, $I_{iso}<1$ mA, 50/60Hz	2500			V
T_J, T_{STG}	Storage Temperature Range	-55		150	°C
T_L	Max Lead Temp for Soldering: 0.063" from case for 10 sec			300	
Torque	Mounting torque (Mounting = 8-32 or 4mm Machine and terminals = 4mm Machine)			1.5	N.m
Wt	Package Weight		29.2		g

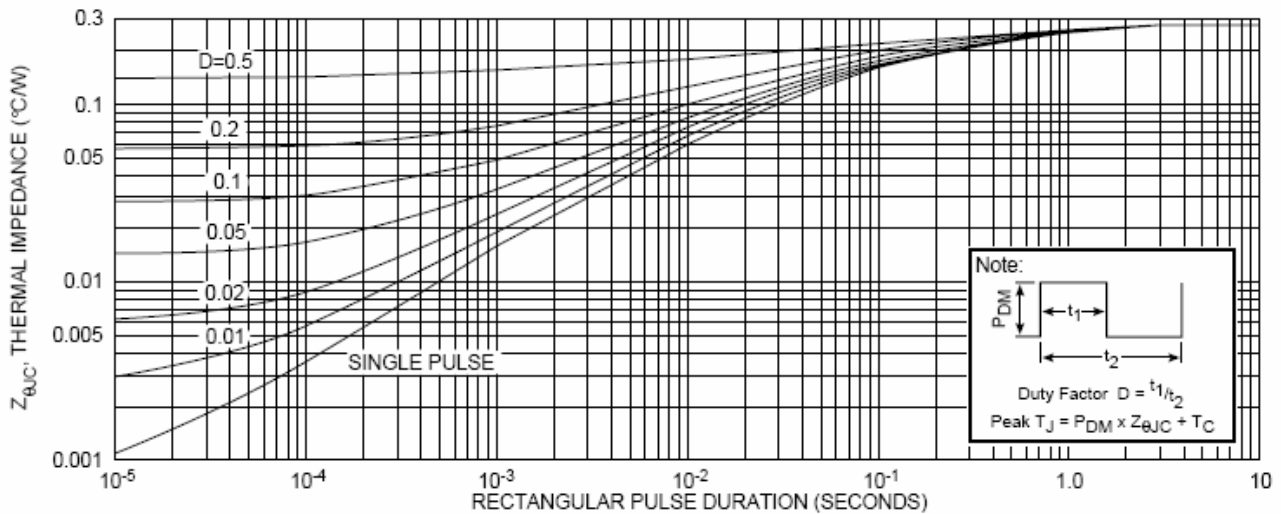
Typical MOSFET Performance Curve

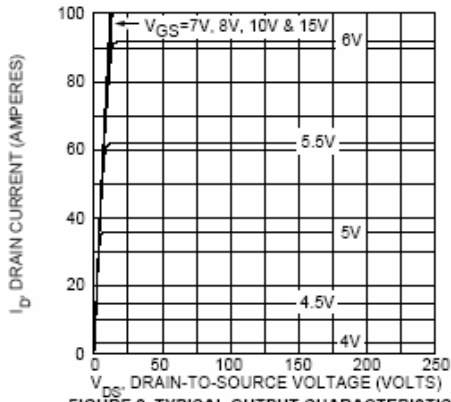

FIGURE 2, TYPICAL OUTPUT CHARACTERISTICS

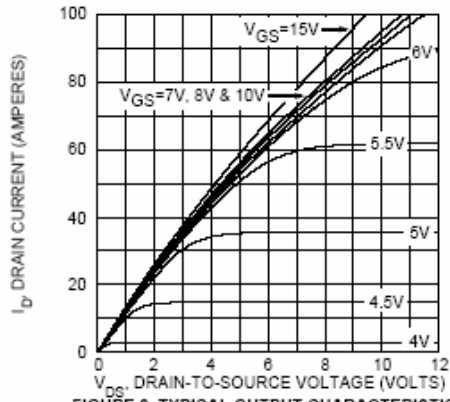

FIGURE 3, TYPICAL OUTPUT CHARACTERISTICS

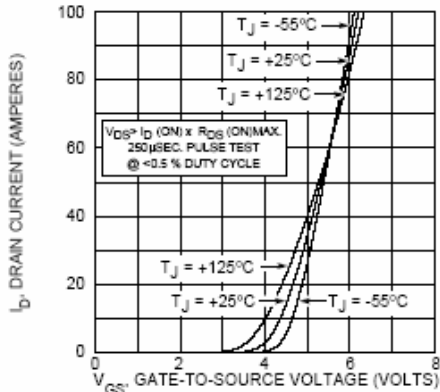

FIGURE 4, TYPICAL TRANSFER CHARACTERISTICS

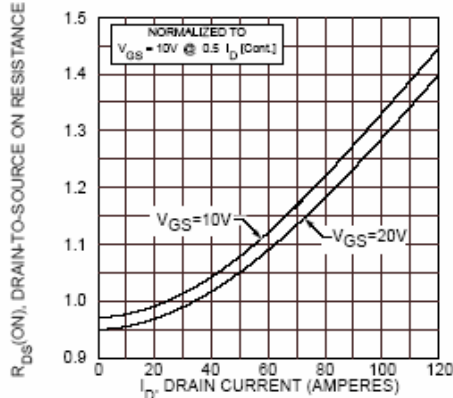

FIGURE 5, $R_{DS(ON)}$ vs DRAIN CURRENT

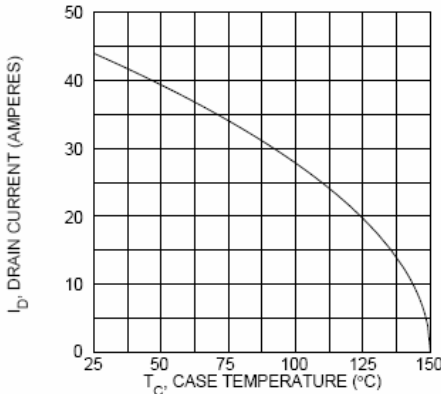

FIGURE 6, MAXIMUM DRAIN CURRENT vs CASE TEMPERATURE

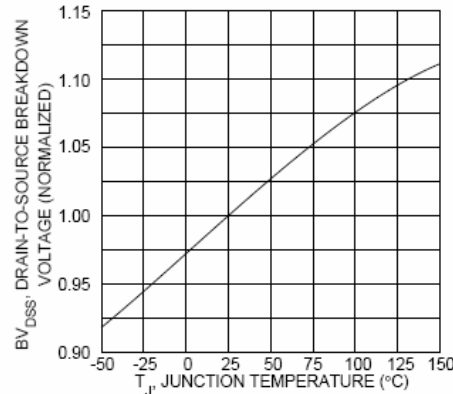

FIGURE 7, BREAKDOWN VOLTAGE vs TEMPERATURE

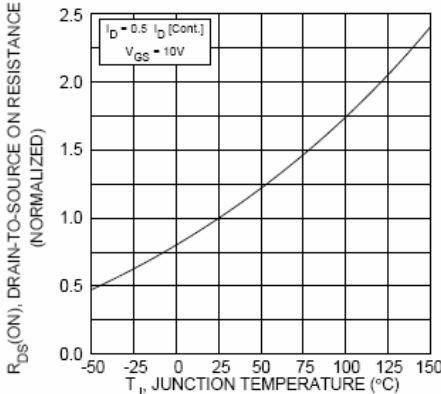

FIGURE 8, ON-RESISTANCE vs. TEMPERATURE

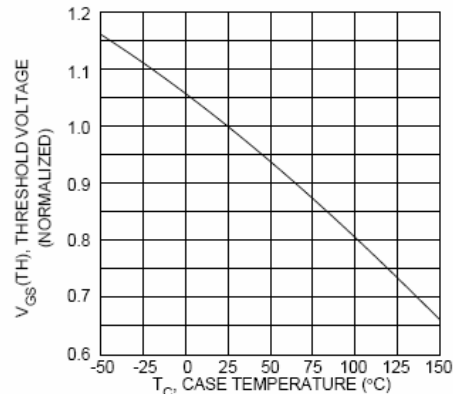

FIGURE 9, THRESHOLD VOLTAGE vs TEMPERATURE

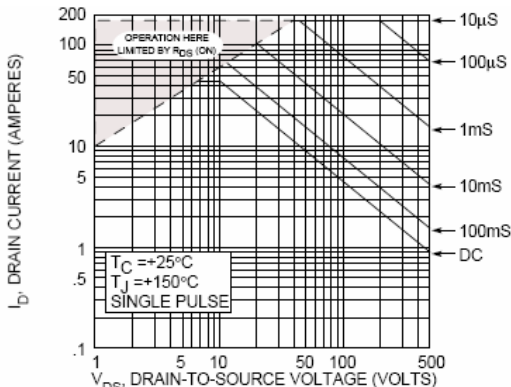

FIGURE 10, MAXIMUM SAFE OPERATING AREA

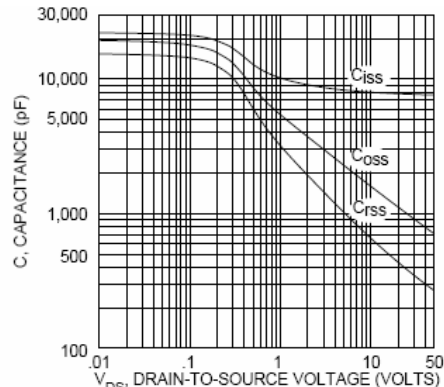

FIGURE 11, TYPICAL CAPACITANCE vs DRAIN-TO-SOURCE VOLTAGE

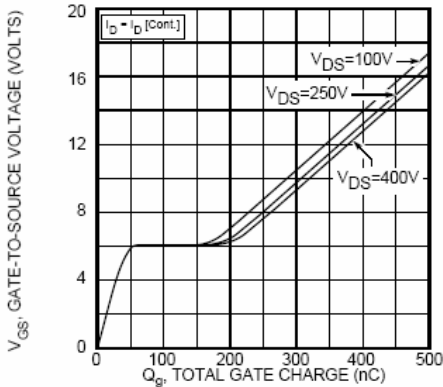

FIGURE 12, GATE CHARGES vs GATE-TO-SOURCE VOLTAGE

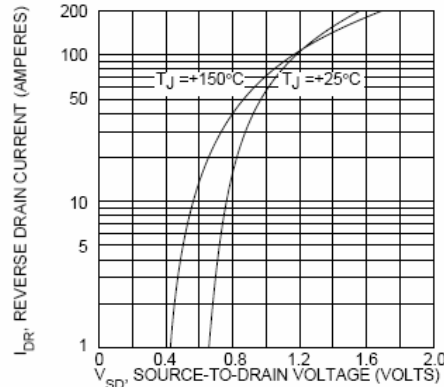

FIGURE 13, TYPICAL SOURCE-DRAIN DIODE FORWARD VOLTAGE

Typical Diode Performance Curve

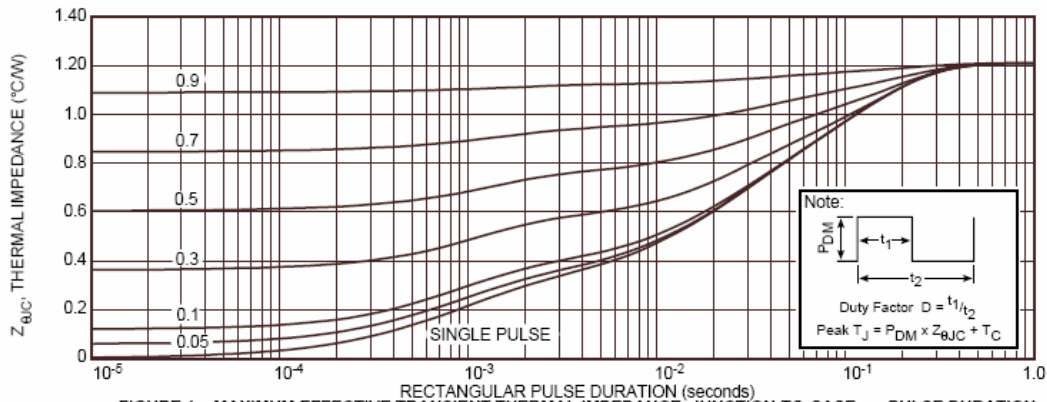

FIGURE 1a. MAXIMUM EFFECTIVE TRANSIENT THERMAL IMPEDANCE, JUNCTION-TO-CASE vs. PULSE DURATION

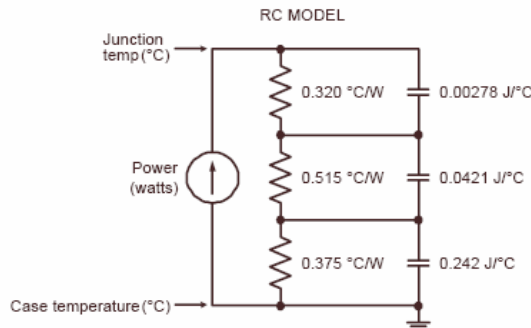

FIGURE 1b, TRANSIENT THERMAL IMPEDANCE MODEL

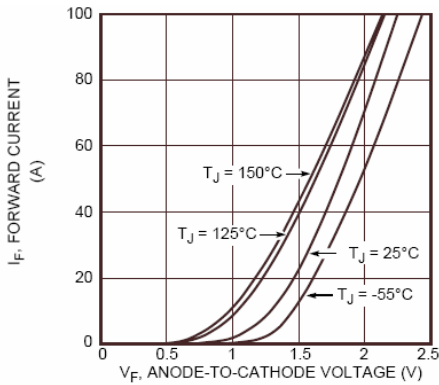

Figure 2. Forward Current vs. Forward Voltage

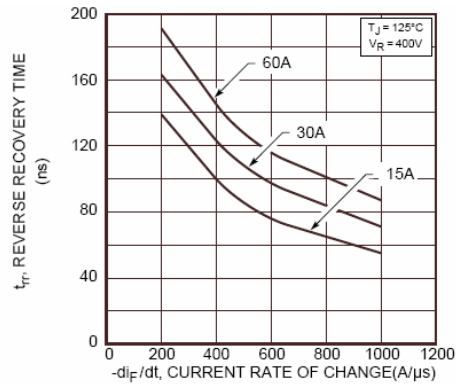

Figure 3. Reverse Recovery Time vs. Current Rate of Change

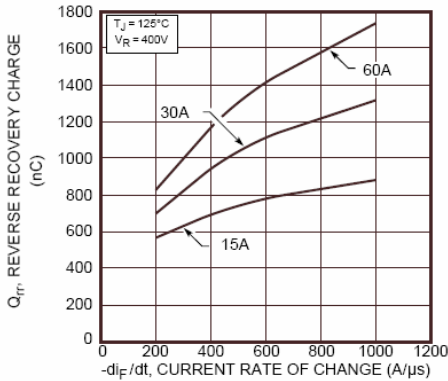

Figure 4. Reverse Recovery Charge vs. Current Rate of Change

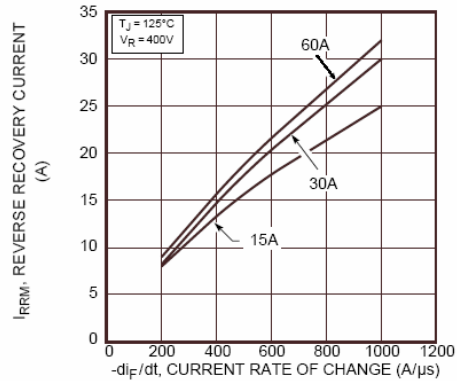

Figure 5. Reverse Recovery Current vs. Current Rate of Change

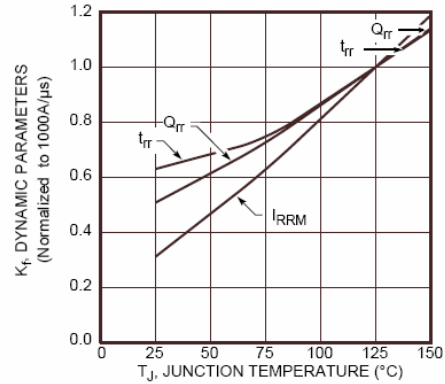

Figure 6. Dynamic Parameters vs. Junction Temperature

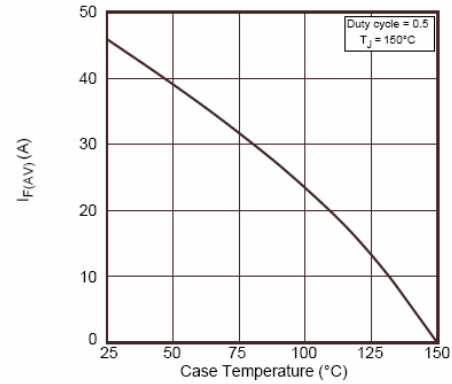

Figure 7. Maximum Average Forward Current vs. Case Temperature

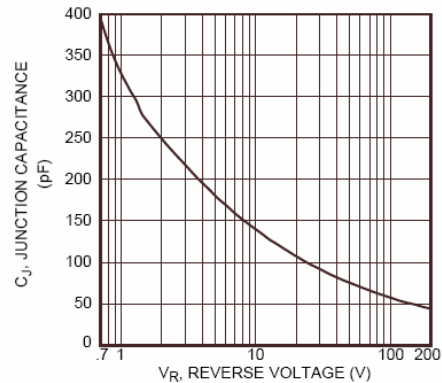

Figure 8. Junction Capacitance vs. Reverse Voltage

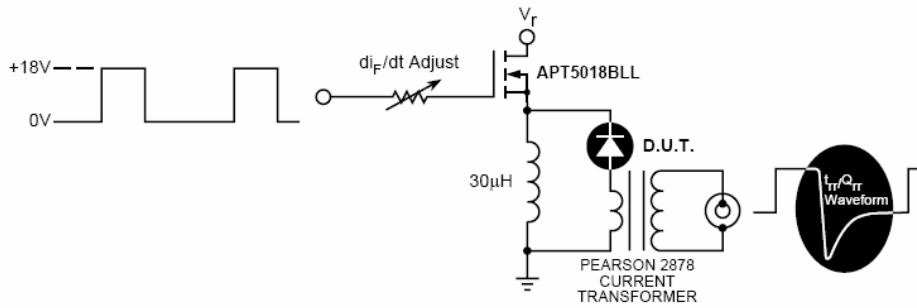

Figure 9. Diode Test Circuit

- 1 I_F - Forward Conduction Current
- 2 di_F/dt - Rate of Diode Current Change Through Zero Crossing.
- 3 I_{RRM} - Maximum Reverse Recovery Current.
- 4 t_{rr} - Reverse Recovery Time, measured from zero crossing where diode current goes from positive to negative, to the point at which the straight line through I_{RRM} and $0.25 \cdot I_{RRM}$ passes through zero.
- 5 Q_{rr} - Area Under the Curve Defined by I_{RRM} and t_{rr} .

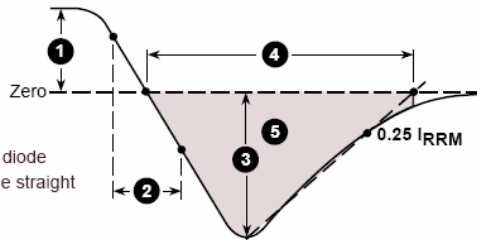
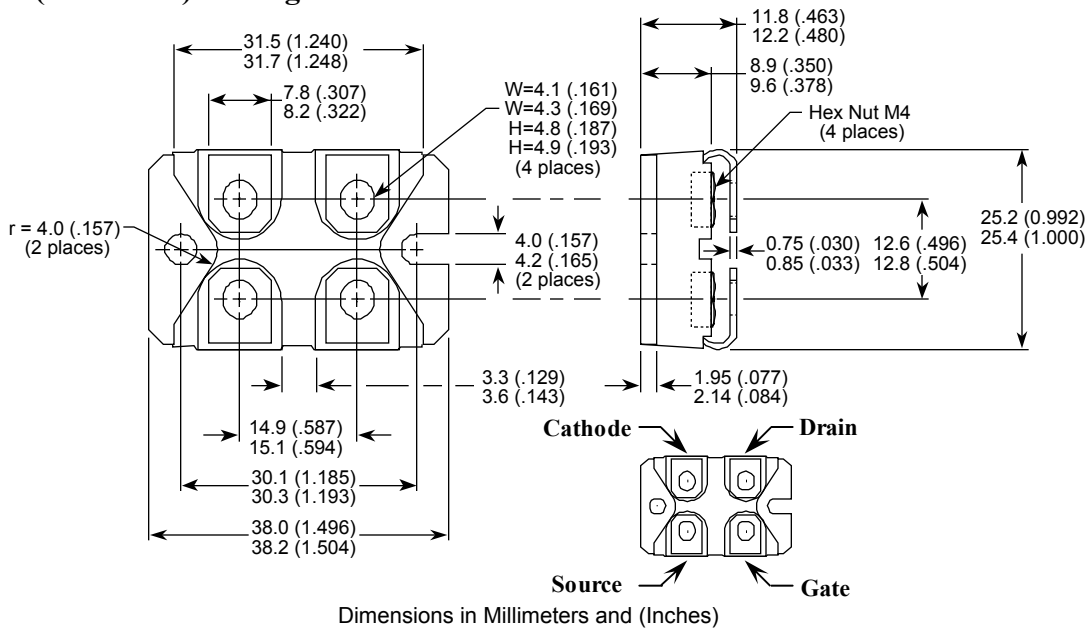

Figure 10. Diode Reverse Recovery Waveform and Definitions

SOT-227 (ISOTOP[®]) Package Outline



ISOTOP[®] is a registered trademark of ST Microelectronics NV

Microsemi reserves the right to change, without notice, the specifications and information contained herein

Microsemi's products are covered by one or more of U.S. patents 4,895,810 5,045,903 5,089,434 5,182,234 5,019,522 5,262,336 6,503,786 5,256,583 4,748,103 5,283,202 5,231,474 5,434,095 5,528,058 and foreign patents. U.S. and Foreign patents pending. All Rights Reserved.