

M52036SP

SYNC SIGNAL PROCESSOR

REJ03F0086-0100Z

Rev.1.0

Sep.22.2003

Description

The M52036SP is a semiconductor integrated circuit for the automatic selection and rectification of sync waveforms. The IC operates with synchronizing signals in three forms, that is, separate sync(positive or negative polarity, 1 to 5 Vp-p), composite sync (positive or negative polarity, 1 to 5 Vp-p), and synchronous video (negative sync). This IC is optimal for processing sync signals for multi-scan-type displays.

Features

- Indicates the presence or absence of synchronizing-signal input and the polarities of the signals
- Pulse-output circuit is for open-collector output
- Clamp-pulse output and Clamp-pulse trigger is generated at the front edge for separate sync and composite sync input, and at the rear edge for sync on video input.
- 20-pin shrink-DIP

Application

- Display Monitor

Recommended Operating Condition

- Supply voltage range: 11 to 13 V
- Rated supply voltage: 12 V

Block Diagram

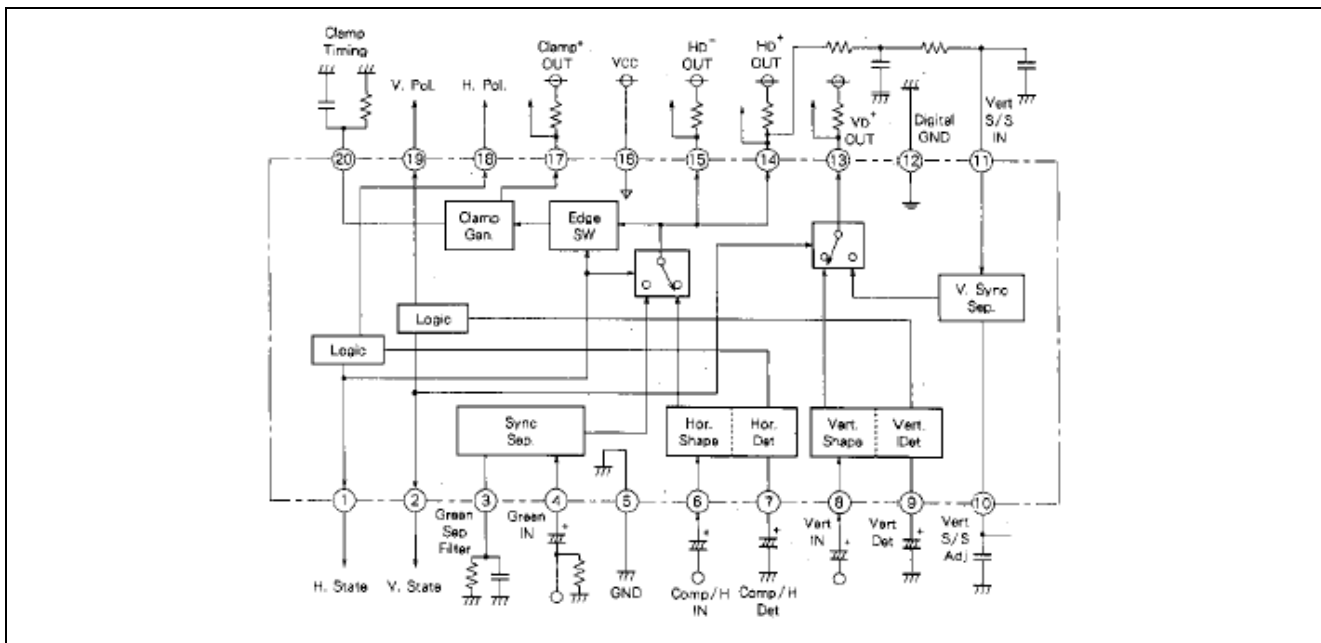

Pin Functions

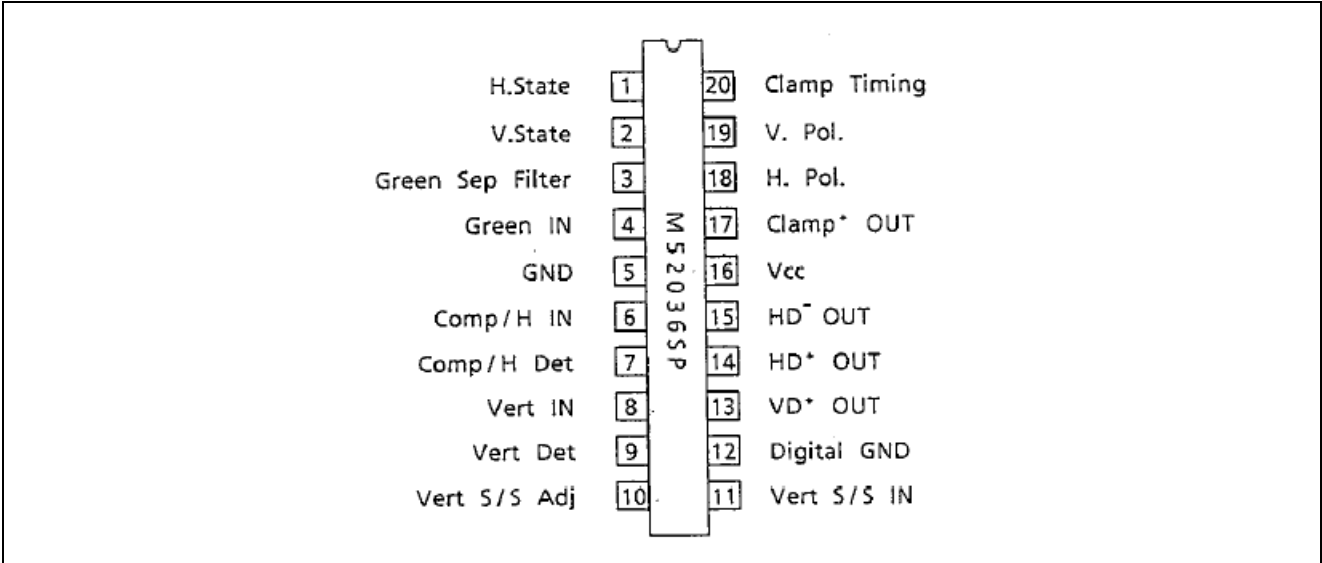

Absolute Maximum Rating

Item	Symbol	Rated values	Units
Supply voltage	Vcc	14.0	V
Power dissipation	Pd	1000	mW
Operating ambient temperature	Topr	-20 to 85	°C
Storing temperature	Tstg	-40 to 150	°C

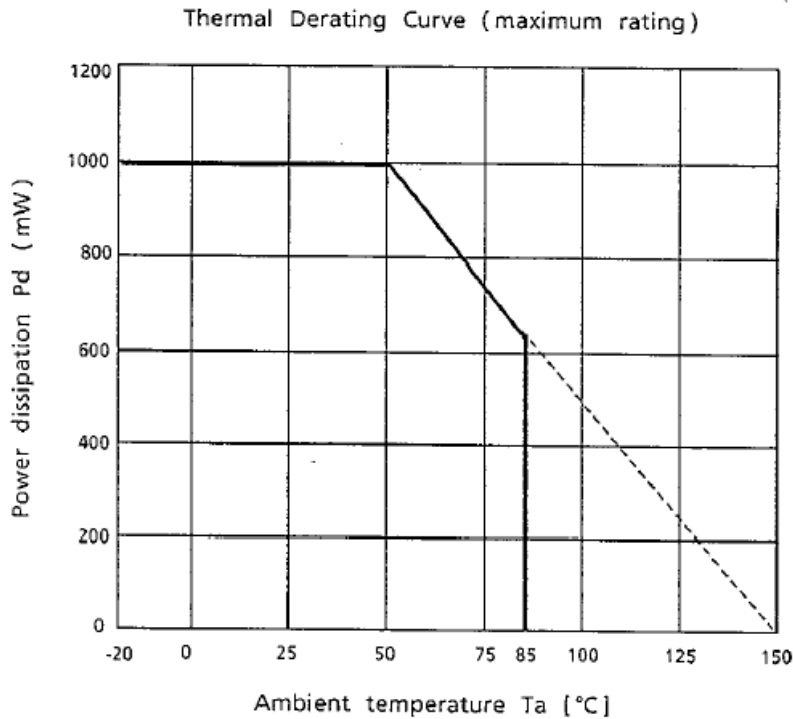





Electrical Characteristics

(Ta = 25°C Vcc = 12 V, VDD = Open)

No.	Items	Symbols	Switch conditions			Input pins	Input conditions	Output pins	Output waveform	Rated values			Types of Unit	Remarks
			4	6	8					Min.	Typ.	Max.		
1	Circuit current	Icc	2	2	2	2	16	A		25	35	45	mA	Pins 4, 6, and 8 shall have no input signal. The input pin shall be connected to GND via a capacitor. Refer to Attached Table 2 for truth table.
2	Pin 1 output Hi level	1OH	2	1	1	1	6	1	DC	4.0	5.0	5.3	V	
3	Pin 1 output Low level	1OL	2	1	1	1	6	1	DC	-	-	0.5	V	
4	Pin 2 output Hi leve	2OH	2	1	1	1	6	1	DC	4.0	5.0	5.3	V	
5	Pin 2 output Low level	2OL	2	1	1	1	6	1	DC	-	-	0.5	V	
6	Pin 18 output Hi level	18OH	2	1	1	1	6	1	DC	4.0	5.0	5.3	V	
														8
7	Pin 18 output Low level	18OL	2	1	1	1	6	1	DC	-	-	0.5	V	
														8
8	Pin 19 output Hi level	19OH	2	1	1	1	6	1	DC	4.0	5.0	5.3	V	
														8
9	Pin 19 output Low level	19OL	2	1	1	1	6	1	DC	-	-	0.5	V	
														8
10	Threshold voltage	V10	2	2	2	1		10	DC	0.7	1.0	1.4	V	

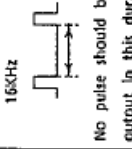
Electrical Characteristics (cont.)

(Ta = 25°C Vcc = 12 V, V_{DD} = Open)

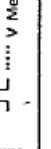
No.	Items	Symbols	Switch conditions			Input pins	Input conditions	Output pins	Output waveforms	Rated values			Types of Unit	Remarks
			4	6	8					16	Min.	Typ.		
11	Maximum noise amplitude of voltage of input signal	SS-NV	1	2	2	1	4	14	No pulse should be output.	--	--	0.1	V	The input signal 0.1V _{p-p} is a dummy noise signal.
12	Minimum voltage amplitude of input signal	SS-LV	1	2	2	1	4	14	 16KHz No pulse should be output in this duration.	0.2	--	--	V	If malfunction by noise occurs is checked.
13	15pin HD* Output Low level	15OL	1	1	2	1	4/6	15	 7.5µs V Meas	--	--	0.5	V	
14	14pin HD* Output Low level	14OL	1	1	2	1	4/6	14	 7.5µs V Meas	--	--	0.5	V	
15	17pin CP* Output Low level	17OL	1	1	2	1	4/6	17	 7.5µs V Meas	--	--	0.5	V	
16	13pin VD* Output Low level	13OL	2	2	1	1	8	13	 7.5µs V Meas	--	--	0.5	V	

Electrical Characteristics (cont.)

(Ta = 25°C Vcc = 12 V, VDD = Open)

No.	Items	Symbols	Switch conditions			Input pins	Input conditions	Output pins	Output waveforms	Rated values		Types of Unit	Remarks	
			4	6	8					16	Min.			Typ. Max.
17	HD*—delay time (A)	HD*—DA	1	1	2	1	4/6	15		—	120	350	ns	
18	HD*—delay time (B)	HD*—DB	1	1	2	1	4/6	15		—	150	350	ns	
19	HD*—delay time (A)	HD*—DA	1	1	2	1	4/6	14		—	120	350	ns	
20	HD*—delay time (B)	HD*—DB	1	1	2	1	4/6	14		—	100	350	ns	
21	CP*—delay time	CP*—DT	1	1	2	1	4/6	17		—	120	350	ns	
22	CP*—PULSE—WIDTH	CP*—PW	1	1	2	1	4/6	17		450	700	950	ns	
23	VD*—delay time (A)	VD*—DA	2	2	1	1	8	13		—	120	350	ns	
24	VD*—delay time (B)	VD*—DB	2	2	1	1	8	13		—	100	350	ns	

Logic Table

Table.1 Decoder Logic Output

Input to pin 6 HD.COMP	Input to pin 8 VD	Output pins			
		1	2	18	19
HD. COMP. (POS)	NON	H	L	L	L
HD. COMP. (POS)	VD (POS)	H	H	L	L
HD. COMP. (POS)	VD (NEG)	H	H	L	H
HD. COMP. (NEG)	NON	H	L	H	L
HD. COMP. (NEG)	VD (POS)	H	H	H	L
HD. COMP. (NEG)	VD (NEG)	H	H	H	H
NON	NON	L	L	L	L
NON	VD (POS)	L	H	L	L
NON	VD (NEG)	L	H	L	H

Table.2 Allowable Amplitude of Input Voltage

Amplitude of input to pin 4	 <p>V_v 0~2.1 (VP-P) V_s 0.2~0.6 (VP-P)</p>
Amplitude of input to pin 6	 <p>F_v 15kHz~200kHz V_s 1.0~5.0 (VP-P)</p>
Amplitude of input to pin 8	 <p>F_v 40Hz~200Hz V_s 1.0~5.0 (VP-P)</p>

Table.3 Output Priority

Input signals (pin)			Output signals (pin)		
4 pin	6 pin	8 pin	14 pin 15 pin	13 pin	17 pin
O	×	×	4	11	4
O	O	×	6	11	6
O	×	O	4	8	4
O	O	O	6	8	6
×	×	×	×	×	×
×	O	×	6	11	6
×	×	O	×	8	×
×	O	O	6	8	6

Table.4 Pulse Duty Ratio for Allowable Maximum Input Signal

Input Pulse to Pin 6 (HD.COMP.)

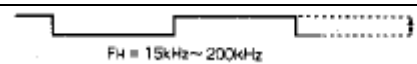
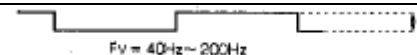
 $F_H = 16 \text{ kHz}$

Maximum voltage amplitude (V_{P-P})		1.0	3.3	4.0	5.0
POS.	%	15.0	13.8	11.2	9.0
	Time (μs)	9.38	8.63	7.00	8.63
NEG.	%	15.0	13.0	10.5	8.8
	Time (μs)	9.38	8.13	6.56	5.50

Input Pulse to Pin 8 (VD)

 $F_V = 60 \text{ Hz}$

Maximum voltage amplitude (V_{P-P})		1.0	3.3	4.0	5.0
POS.	%	14.1	12.1	9.8	7.7
	Time (ms)	2.35	2.02	1.63	1.28
NEG.	%	14.8	11.3	9.2	7.5
	Time (ms)	2.47	1.88	1.53	1.25

Precautions for Application

1. Input

- 1) Green (Sync on Video) input (pins [3] and [4])

The input signals must be in sync negative polarity.

For sync separation, a method is used in which the sync tip is clamped by a capacitor attached externally to pin [4] and by the C and R attached to pin [3].

Then sync tip of pin [4] shows approximately 4 V.

2) Comp Sync/H sync, V sync input

Connect the composite sync input to pin [6]. For the separate sync input, connect H and V to pins[6] and [8] respectively. The bias and impedance at pins [6] and [8] are 6 V and 10 kΩ, respectively.

Waveform shaping and polarity detection are performed by a double threshold converter installed inside.

The internal circuit is as shown in Fig.B. The average DC voltage is set to approximately 0.7 V higher and lower than V_2 .

Thus, as shown in Fig. A, this processor is energized by an input signal 0.7 Vp-p or over when the duty ratio is small. On the other hand, approximately 1.4 Vp-p is suitable when the duty ratio is large. Fig. C indicates an allowable standard value for the input duty.

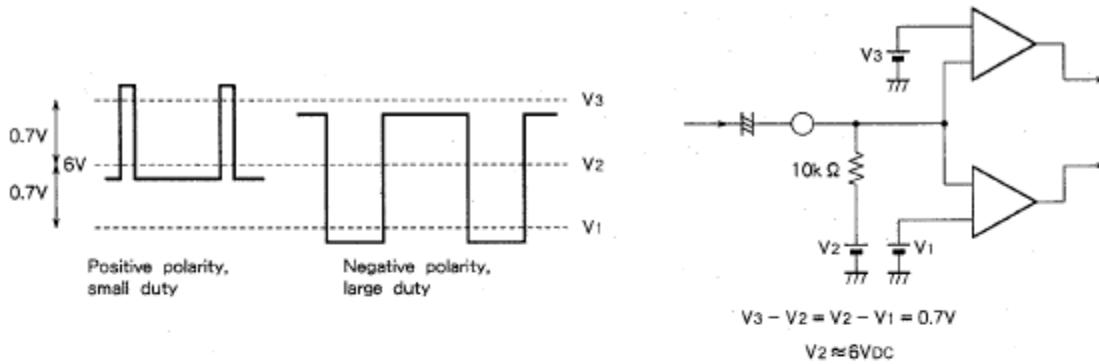

Fig. A

Fig. B

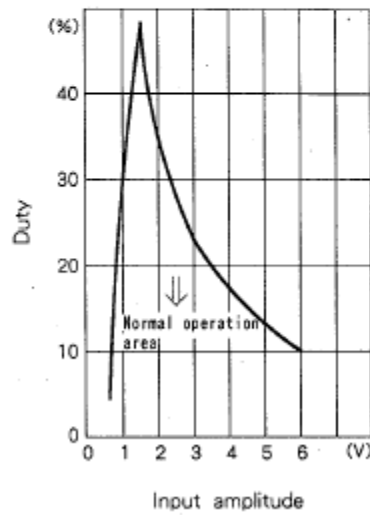
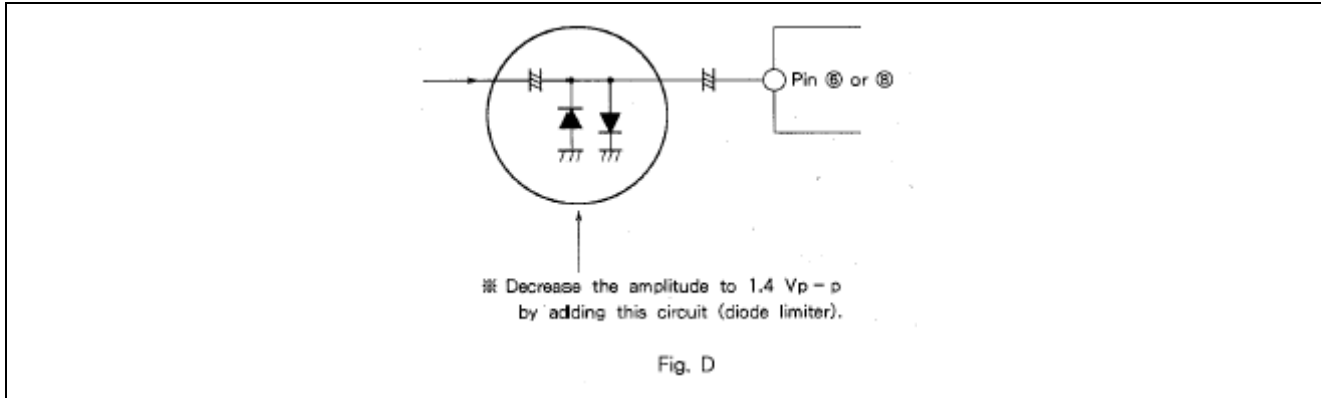
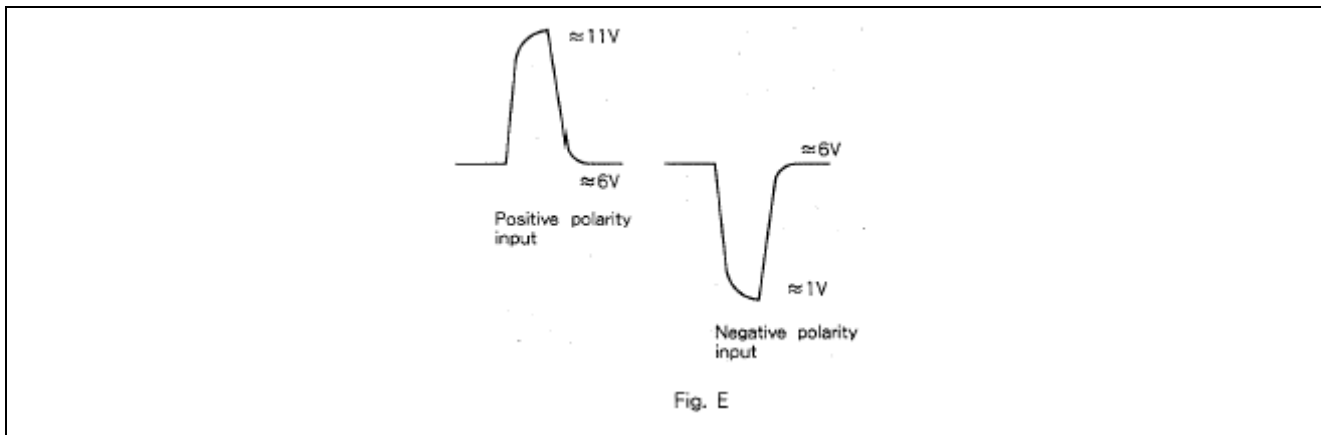

Fig. C

Fig. D shows an example of the measures for improving the allowable duty ratio in a range of 1.4 V_{p-p} or over of the input signal.



For use in a range outside the specified value, confirm that the waveform complies with Fig. E when measured it after removing the filters in pins [7] and [9].



3) Polarity detection and empty input detection (pins [7] and [9])

A capacitor is required to be installed external as a filter for polarity detection and empty input detection. The larger the capacitance, the smaller the ripple and reduces malfunction. However, the detecting time is lengthened.

For an input of 15 kHz, a capacitor of 0.05 μF or larger is recommended. For 60 Hz, a 10 μF or larger is sufficient. If it is necessary to use a capacitor of smaller capacitance, measure the waveform at the filter terminal under the condition of the lowest frequency of the input sync signal to be used and the smallest duty ratio. And make sure that the signal shows 7.5 V (actually 6.6 V) or over for positive polarity input or 4.5 V (actually 5.5 V) or lower for a negative polarity input.

4) VERT S/S IN (pins [11])

For V sync separation, signals are generated by externally integrating composite sync signals, and are then input.

The composite sync signals that are input to pin [6] (H + V) are output to pin [14] HD⁺. For V sync separation, pin [14] HD⁺ output is externally integrated, and input to pin [11]. Check pin [11] waveform to see if the H element is adequately low.

In the IC, the sync separation threshold level is set to approximately 1 V when no external adjustment is provided.

5) VERT S/S ADJ (pins [10])

The threshold voltage is approximately 1 V when no external adjustment is provided. The threshold voltage is dependent on IC internal resistance. Pin [10] may be open; however, if noise may give adverse effect, ground the pin with capacitor.

When the H element cannot be lowered sufficiently, connect resistance between pin [10] and V_{CC} to change the threshold level. (Provide resistance such that when V_{DD} (Digital V_{CC}) is 12 V, the threshold voltage will be 8 V or less; and when V_{DD} is 5 V, the threshold voltage will be 4 V or less.)

When there are serration pulses or other pulses during the V period, provide resistance such that the threshold voltage will be half as high as V_{DD}.

2. CP-Width

Timing terminal (pins [20])

The time constant depends on the current flowing out through pin [20] and the capacitance of the timing terminal. The current flowing out through pin [20] is usually determined by the terminal voltage and the resistance of externally attached resistor. A pulse width of 0.7 μ sec is obtained by an 18 k Ω (or 200 μ A) resistor and a 100 pF capacitor both installed externally.

3. Output stage

1) Logic output (pins [1], [2], [18] and [19])

This output system is illustrated in the figure shown below. The internal load resistance of this IC is 20 k Ω .

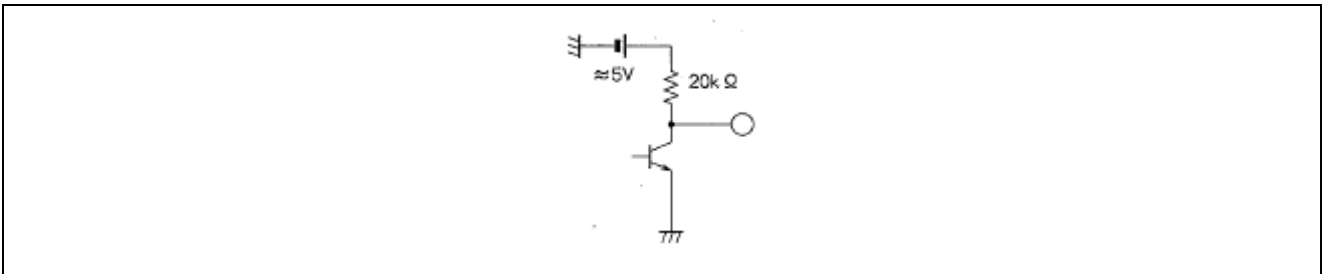

2) Pulse output (pins [13], [14], [15] and [17])

This output system is of open collector type as illustrated in the figure shown below. Approximately 6 mA can be charged in.

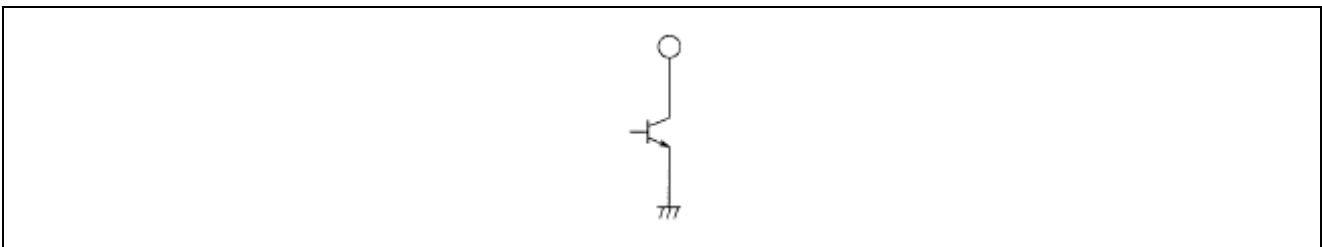

3) Power supply

Supply 12 V to pin [16].

For the pulse output power, supply a digital V_{CC} of 5 to 12 V as illustrated below.

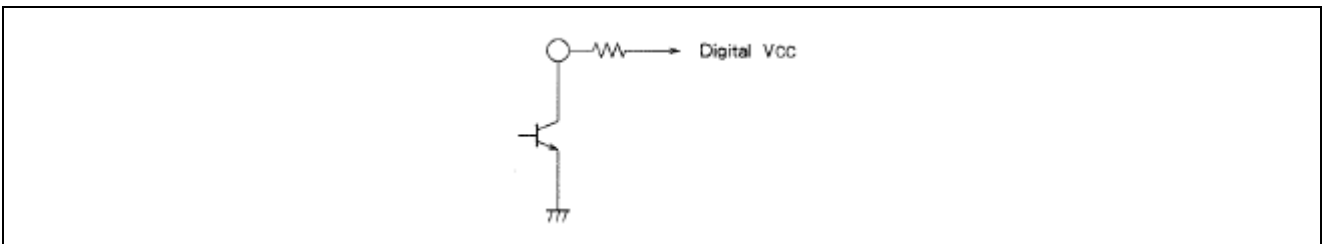

4. Other

Differences between M52036SP and M52346SP

The clamp pulse trigger is different between M52036SP and M52346SP when “S on G” and “H/H + V” are input simultaneously, or when only “H/H + V” is input.

M52036SP: Generated at the first edge of “H/H + V” input.

M52346SP: Generated at the latter edge of “H/H + V” input.

M52346SP clamp pulses are generated at the latter edge of signals that have been given priority.

The M52036SP pin configuration is the same as that of M52346SP.

Package Dimensions

Plastic 20pin 300mil SDIP

MMP

20P4B

EIAJ Package Code SDIP20-P-300-1.78	JEDEC Code —	Weight(g) 1.0	Lead Material Alloy 42/Cu Alloy
--	-----------------	------------------	------------------------------------

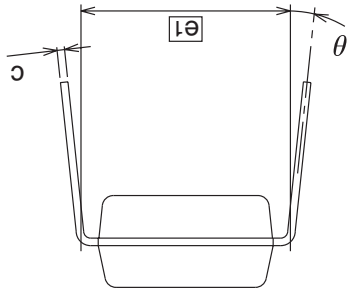
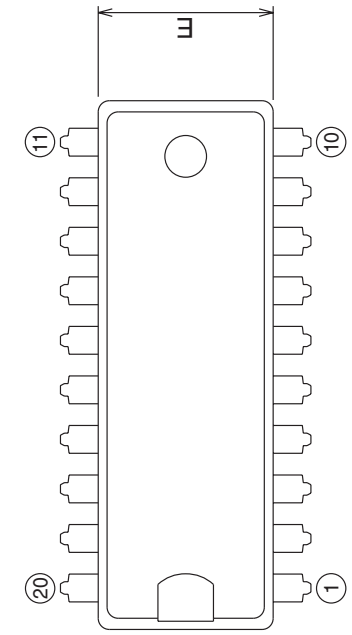

Symbol	Dimension in Millimeters		
	Min	Nom	Max
A	—	—	4.5
A1	0.51	—	—
A2	—	3.3	—
b	0.38	0.48	0.58
b1	0.9	1.0	1.3
c	0.22	0.27	0.34
D	18.8	19.0	19.2
E	6.15	6.3	6.45
e	—	1.778	—
e1	—	7.62	—
L	3.0	—	—
θ	0°	—	15°

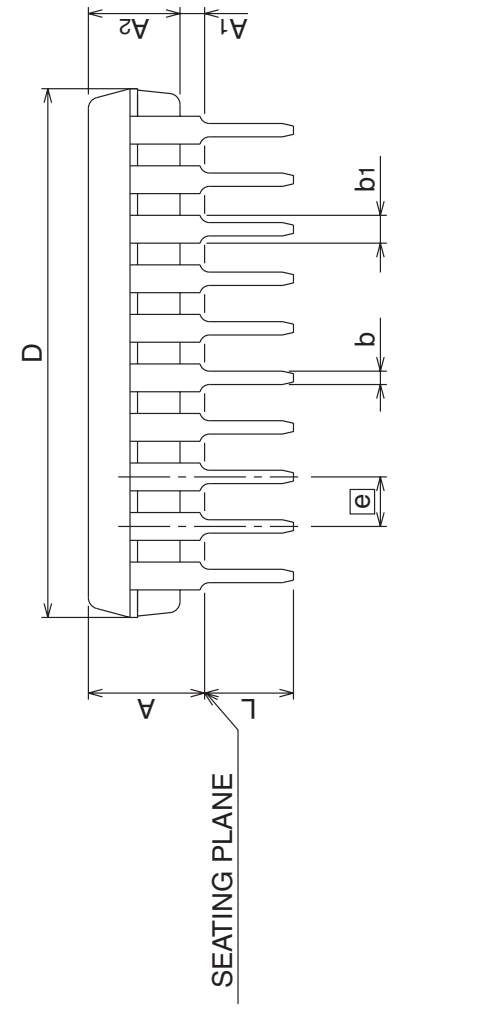

RENESAS Technology Corp. Sales Strategic Planning Div. Nippon Bldg., 2-6-2, Ohte-machi, Chiyoda-ku, Tokyo 100-0004, Japan

Keep safety first in your circuit designs!

1. Renesas Technology Corp. puts the maximum effort into making semiconductor products better and more reliable, but there is always the possibility that trouble may occur with them. Trouble with semiconductors may lead to personal injury, fire or property damage.
Remember to give due consideration to safety when making your circuit designs, with appropriate measures such as (i) placement of substitutive, auxiliary circuits, (ii) use of nonflammable material or (iii) prevention against any malfunction or mishap.

Notes regarding these materials

1. These materials are intended as a reference to assist our customers in the selection of the Renesas Technology Corp. product best suited to the customer's application; they do not convey any license under any intellectual property rights, or any other rights, belonging to Renesas Technology Corp. or a third party.
 2. Renesas Technology Corp. assumes no responsibility for any damage, or infringement of any third-party's rights, originating in the use of any product data, diagrams, charts, programs, algorithms, or circuit application examples contained in these materials.
 3. All information contained in these materials, including product data, diagrams, charts, programs and algorithms represents information on products at the time of publication of these materials, and are subject to change by Renesas Technology Corp. without notice due to product improvements or other reasons. It is therefore recommended that customers contact Renesas Technology Corp. or an authorized Renesas Technology Corp. product distributor for the latest product information before purchasing a product listed herein.
The information described here may contain technical inaccuracies or typographical errors.
Renesas Technology Corp. assumes no responsibility for any damage, liability, or other loss rising from these inaccuracies or errors.
Please also pay attention to information published by Renesas Technology Corp. by various means, including the Renesas Technology Corp. Semiconductor home page (<http://www.renesas.com>).
 4. When using any or all of the information contained in these materials, including product data, diagrams, charts, programs, and algorithms, please be sure to evaluate all information as a total system before making a final decision on the applicability of the information and products. Renesas Technology Corp. assumes no responsibility for any damage, liability or other loss resulting from the information contained herein.
 5. Renesas Technology Corp. semiconductors are not designed or manufactured for use in a device or system that is used under circumstances in which human life is potentially at stake. Please contact Renesas Technology Corp. or an authorized Renesas Technology Corp. product distributor when considering the use of a product contained herein for any specific purposes, such as apparatus or systems for transportation, vehicular, medical, aerospace, nuclear, or undersea repeater use.
 6. The prior written approval of Renesas Technology Corp. is necessary to reprint or reproduce in whole or in part these materials.
 7. If these products or technologies are subject to the Japanese export control restrictions, they must be exported under a license from the Japanese government and cannot be imported into a country other than the approved destination.
Any diversion or reexport contrary to the export control laws and regulations of Japan and/or the country of destination is prohibited.
 8. Please contact Renesas Technology Corp. for further details on these materials or the products contained therein.
-



RENESAS SALES OFFICES

<http://www.renesas.com>

Renesas Technology America, Inc.
450 Holger Way, San Jose, CA 95134-1368, U.S.A
Tel: <1> (408) 382-7500 Fax: <1> (408) 382-7501

Renesas Technology Europe Limited.
Dukes Meadow, Millboard Road, Bourne End, Buckinghamshire, SL8 5FH, United Kingdom
Tel: <44> (1628) 585 100, Fax: <44> (1628) 585 900

Renesas Technology Europe GmbH
Dornacher Str. 3, D-85622 Feldkirchen, Germany
Tel: <49> (89) 380 70 0, Fax: <49> (89) 929 30 11

Renesas Technology Hong Kong Ltd.
7/F., North Tower, World Finance Centre, Harbour City, Canton Road, Hong Kong
Tel: <852> 2265-6688, Fax: <852> 2375-6836

Renesas Technology Taiwan Co., Ltd.
FL 10, #99, Fu-Hsing N. Rd., Taipei, Taiwan
Tel: <886> (2) 2715-2888, Fax: <886> (2) 2713-2999

Renesas Technology (Shanghai) Co., Ltd.
26/F., Ruijin Building, No.205 Maoming Road (S), Shanghai 200020, China
Tel: <86> (21) 6472-1001, Fax: <86> (21) 6415-2952

Renesas Technology Singapore Pte. Ltd.
1, Harbour Front Avenue, #06-10, Keppel Bay Tower, Singapore 098632
Tel: <65> 6213-0200, Fax: <65> 6278-8001