

CIRCUIT

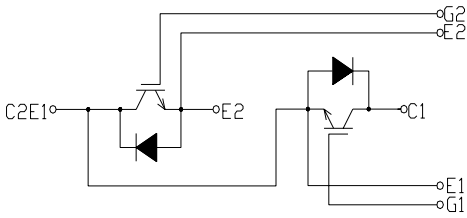

OUTLINE DRAWING

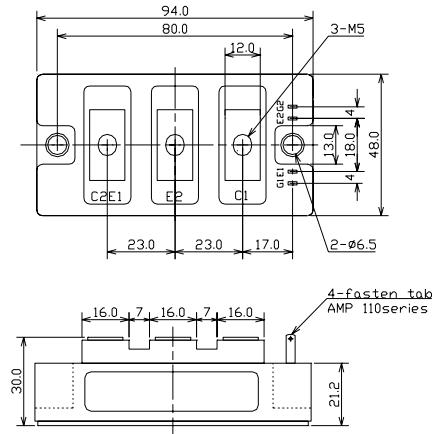

4- fasten- tab No 110

Dimension(mm)

Approximate Weight : 320g

MAXMUM RATINGS (Tc=25°C)

Item	Symbol	PDMB150B12C2	Unit
Collector-Emitter Voltage	V _{CEs}	1200	V
Gate - Emitter Voltage	V _{GEs}	+/- 20	V
Collector Current	DC	I _C	150
	1 ms	I _C	300
Collector Power Dissipation	P _C	730	W
Junction Temperature Range	T _j	-40 to +150	°C
Storage Temperature Range	T _{stg}	-40 to +125	°C
Isolation Voltage (Terminal to Base AC, 1 min.)	V _{ISO}	2500	V
Mounting Torque	Module Base to Heat sink	F _{TOR}	2.04
	Bus Bar to Main Terminals		

ELECTRICAL CHARACTERISTICS (Tc=25°C)

Characteristic	Symbol	Test Condition	Min.	Typ.	Max.	Unit
Collector-Emitter Cut-Off Current	I _{CEs}	V _{CE} =1200V, V _{GE} =0V	-	-	3.0	mA
Gate-Emitter Leakage Current	I _{GES}	V _{GE} =+/- 20V, V _{CE} =0V	-	-	1.0	µA
Collector-Emitter Saturation Voltage	V _{CE(sat)}	I _C =150A, V _{GE} =15V	-	1.9	2.4	V
Gate-Emitter Threshold Voltage	V _{GE(th)}	V _{CE} =5V, I _C =150mA	4.0	-	8.0	V
Input Capacitance	C _{ies}	V _{CE} =10V, V _{GE} =0V, f=1MHz	-	12,600	-	pF
Switching Time	Rise Time	V _{CC} = 600V R _L = 4 ohm R _G =3.6 ohm V _{GE} = +/- 15V	-	0.25	0.45	µs
	Turn-on Time		-	0.40	0.7	
	Fall Time		-	0.25	0.35	
	Turn-off Time		-	0.80	1.10	

FREE WHEELING DIODES RATINGS & CHARACTERISTICS (Tc=25°C)

Item	Symbol	Rated Value	Unit
Forward Current	DC	I _F	150
	1 ms	I _{FM}	300

Characteristic	Symbol	Test Condition	Min.	Typ.	Max.	Unit
Peak Forward Voltage	V _F	I _F =150A, V _{GE} =0V	-	1.9	2.4	V
Reverse Recovery Time	t _{rr}	I _F =150A, V _{GE} =-10V, di/dt=300A/µs	-	0.2	0.3	µs

THERMAL CHARACTERISTICS

Characteristic	Symbol	Test Condition	Min.	Typ.	Max.	Unit
Thermal Impedance	IGBT	Junction to Case	-	-	0.16	°C/W
	DIODE		-	-	0.32	

Fig.1- Output Characteristics (Typical)

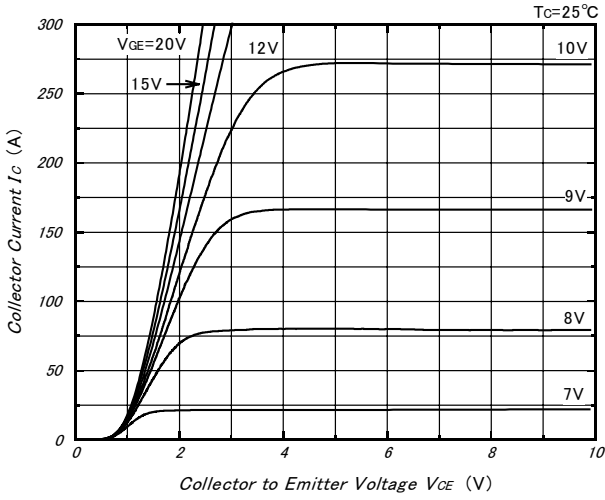

Fig.2- Collector to Emitter On Voltage vs. Gate to Emitter Voltage (Typical)

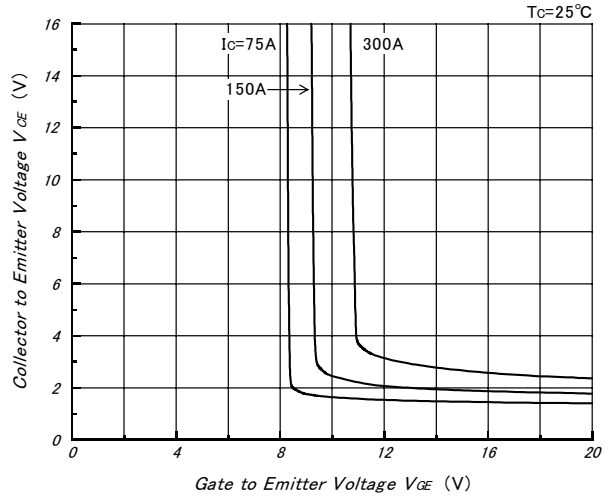

Fig.3- Collector to Emitter On Voltage vs. Gate to Emitter Voltage (Typical)

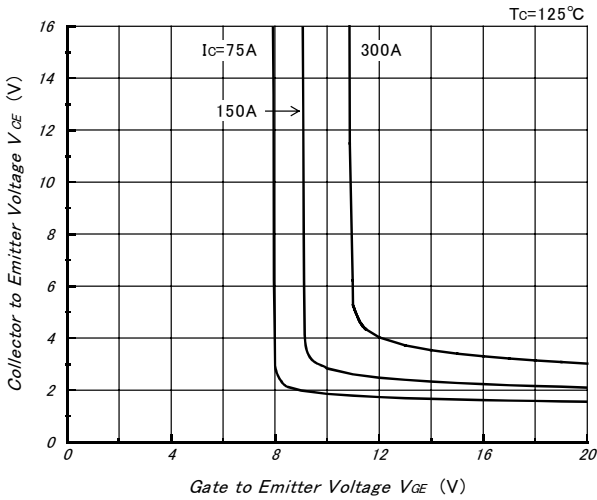

Fig.4- Gate Charge vs. Collector to Emitter Voltage (Typical)

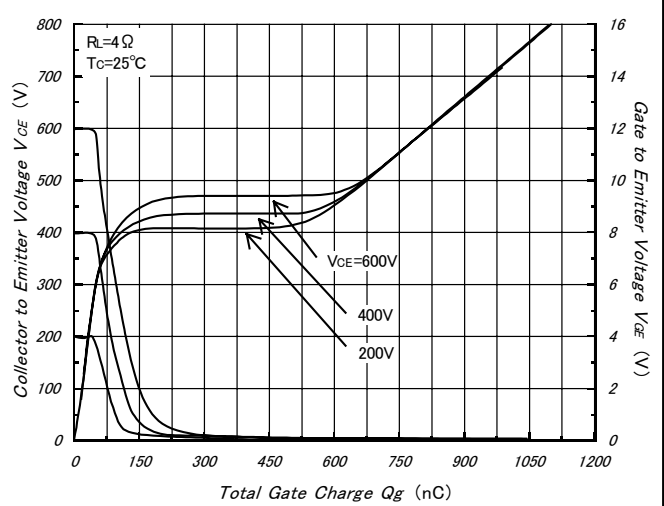

Fig.5- Capacitance vs. Collector to Emitter Voltage (Typical)

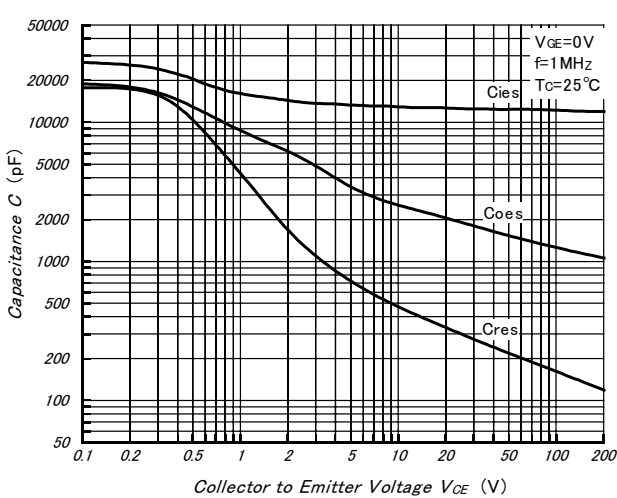

Fig.6- Collector Current vs. Switching Time (Typical)

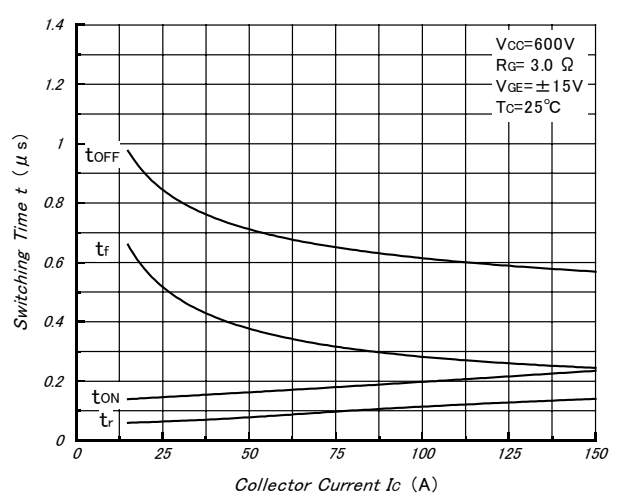

Fig.7- Series Gate Impedance vs. Switching Time (Typical)

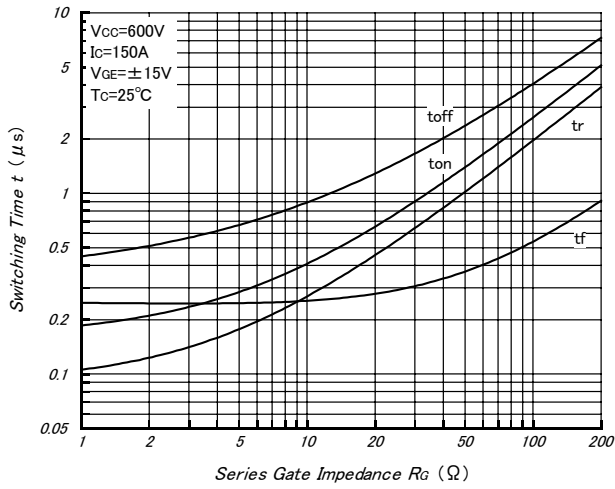

Fig.8- Forward Characteristics of Free Wheeling Diode (Typical)

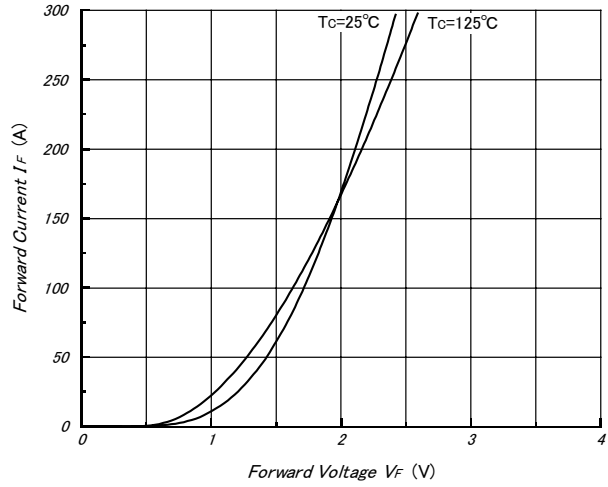

Fig.9- Reverse Recovery Characteristics (Typical)

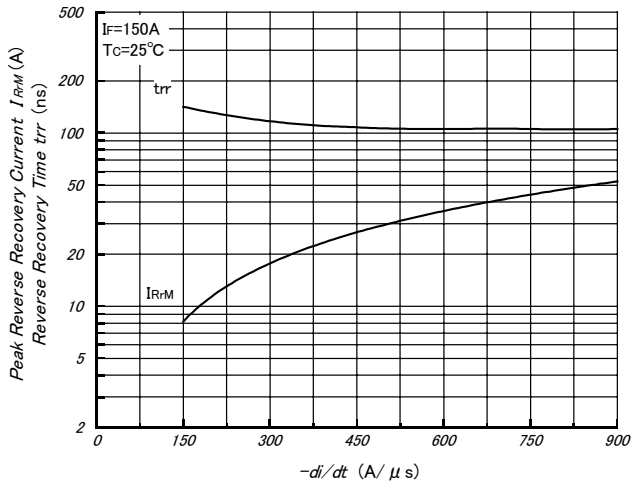

Fig.10- Reverse Bias Safe Operating Area

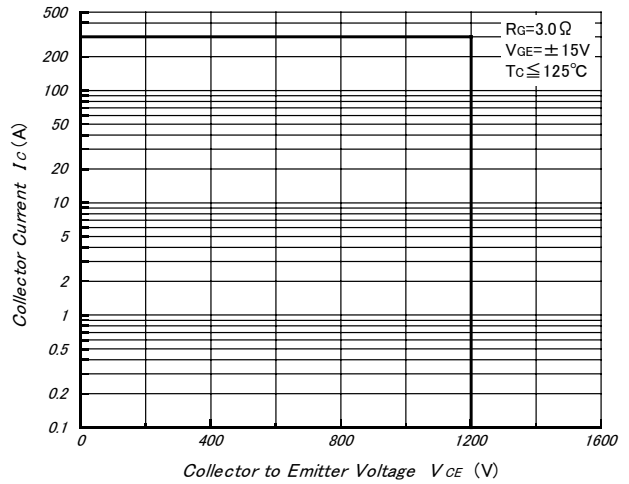

Fig.11- Transient Thermal Impedance

