

**Major Ratings and Characteristics**

Characteristics	200CNQ...	Units
$I_{F(AV)}$ Rectangular waveform	200	A
$V_{RRM}$ range	35 to 45	V
$I_{FSM}$ @ tp = 5 $\mu$ s sine	26,000	A
$V_F$ @ 100Apk, $T_J=125^\circ\text{C}$ (per leg)	0.49	V
$T_J$ range	-55 to 150	$^\circ\text{C}$

**Description/Features**

The 200CNQ center tap Schottky rectifier module series has been optimized for low reverse leakage at high temperature. The proprietary barrier technology allows for reliable operation up to 150  $^\circ\text{C}$  junction temperature. Typical applications are in high current switching power supplies, plating power supplies, UPS systems, converters, free-wheeling diodes, welding, and reverse battery protection.

- 150  $^\circ\text{C}$   $T_J$  operation
- Center tap module
- High purity, high temperature epoxy encapsulation for enhanced mechanical strength and moisture resistance
- Low forward voltage drop
- High frequency operation
- Guard ring for enhanced ruggedness and long term reliability

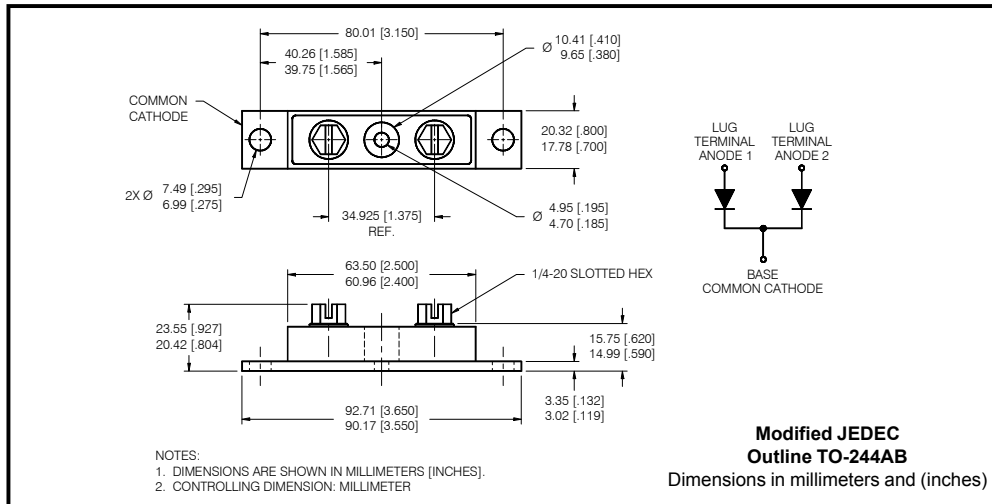

200CNQ... Series

Bulletin PD-2.257 rev. D 07/01

Voltage Ratings

Part number	200CNQ035	200CNQ040	200CNQ045
$V_R$ Max. DC Reverse Voltage (V)	35	40	45
$V_{RWM}$ Max. Working Peak Reverse Voltage (V)			

Absolute Maximum Ratings

Parameters	200CNQ	Units	Conditions
$I_{F(AV)}$ Max. Average Forward Current (Per Leg) * See Fig. 5 (Per Device)	100 200	A	50% duty cycle @ $T_C = 114^\circ\text{C}$ , rectangular wave form
$I_{FSM}$ Max. Peak One Cycle Non-Repetitive Surge Current (Per Leg) * See Fig. 7	26,000 1550	A	5 $\mu\text{s}$ Sine or 3 $\mu\text{s}$ Rect. pulse 10ms Sine or 6ms Rect. pulse Following any rated load condition and with rated $V_{RWM}$ applied
$E_{AS}$ Non-Repetitive Avalanche Energy (Per Leg)	135	mJ	$T_J = 25^\circ\text{C}$ , $I_{AS} = 20$ Amps, $L = 0.67$ mH
$I_{AR}$ Repetitive Avalanche Current (Per Leg)	20	A	Current decaying linearly to zero in 1 $\mu\text{sec}$ Frequency limited by $T_J$ max. $V_A = 1.5 \times V_R$ typical

Electrical Specifications

Parameters	200CNQ	Units	Conditions
$V_{FM}$ Max. Forward Voltage Drop (Per Leg) * See Fig. 1 (1)	0.54	V	@ 100A $T_J = 25^\circ\text{C}$
	0.68	V	@ 200A
	0.49	V	@ 100A $T_J = 125^\circ\text{C}$
	0.64	V	@ 200A
$I_{RM}$ Max. Reverse Leakage Current (Per Leg) * See Fig. 2 (1)	10	mA	$T_J = 25^\circ\text{C}$ $V_R = \text{rated } V_R$
	500	mA	$T_J = 125^\circ\text{C}$
$V_{F(TO)}$ Threshold Voltage	0.32	V	$T_J = T_J \text{ max.}$
$r_f$ Forward Slope Resistance	0.81	m $\Omega$	
$C_T$ Max. Junction Capacitance (Per Leg)	5200	pF	$V_R = 5V_{DC}$ , (test signal range 100Khz to 1Mhz) $25^\circ\text{C}$
$L_S$ Typical Series Inductance (Per Leg)	7.0	nH	From top of terminal hole to mounting plane
$dv/dt$ Max. Voltage Rate of Change (Rated $V_R$ )	10000	V/ $\mu\text{s}$	

Thermal-Mechanical Specifications

(1) Pulse Width < 300 $\mu\text{s}$ , Duty Cycle <2%

Parameters	200CNQ	Units	Conditions
$T_J$ Max. Junction Temperature Range	-55 to 150	$^\circ\text{C}$	
$T_{stg}$ Max. Storage Temperature Range	-55 to 150	$^\circ\text{C}$	
$R_{thJC}$ Max. Thermal Resistance Junction to Case (Per Leg)	0.40	$^\circ\text{C/W}$	DCoperation * See Fig. 4
$R_{thJC}$ Max. Thermal Resistance Junction to Case (Per Package)	0.20	$^\circ\text{C/W}$	DCoperation
$R_{thCS}$ Typical Thermal Resistance, Case to Heatsink	0.10	$^\circ\text{C/W}$	Mounting surface, smooth and greased
wt Approximate Weight	79(2.80)	g (oz.)	
T Mounting Torque Base	Min.	24 (20)	Kg-cm (lbf-in)
	Max.	35 (30)	
	Typ.	13.5 (12)	
	Min.	35 (30)	
	Max.	46 (40)	
Terminal Torque			
Case Style	TO-244AB		Modified JEDEC

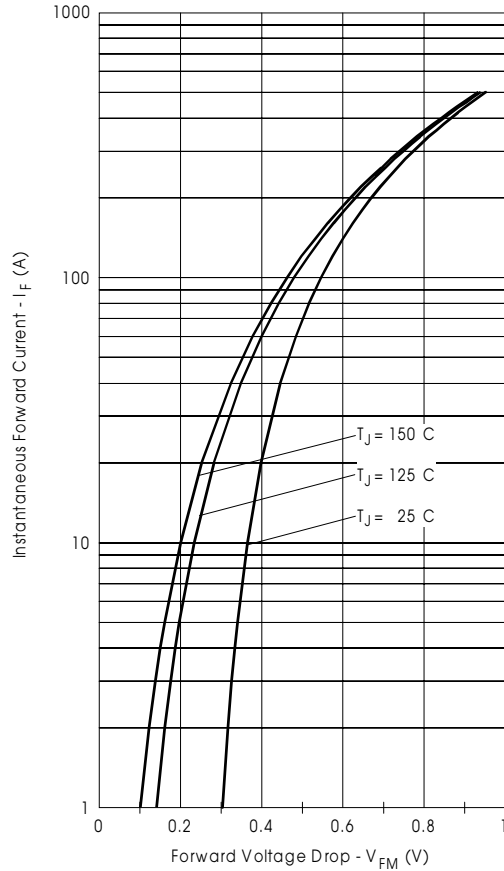

Fig. 1 - Max. Forward Voltage Drop Characteristics (Per Leg)

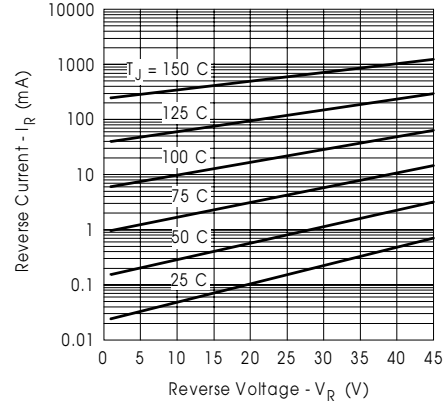

Fig. 2 - Typical Values Of Reverse Current Vs. Reverse Voltage (Per Leg)

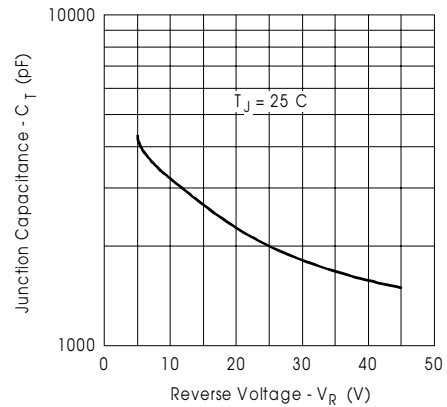

Fig. 3 - Typical Junction Capacitance Vs. Reverse Voltage (Per Leg)

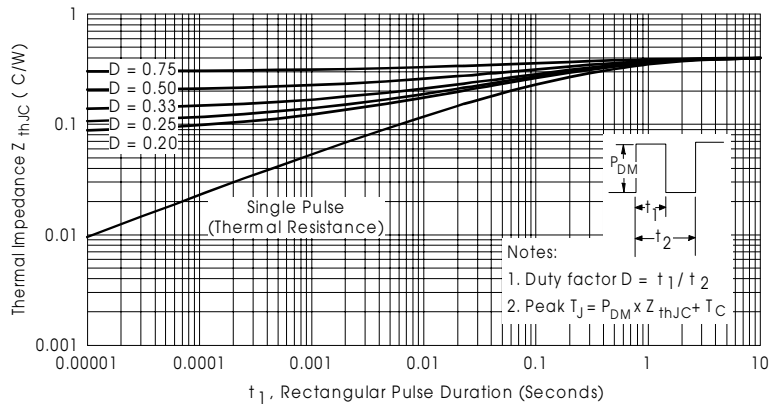

Fig. 4 - Max. Thermal Impedance  $Z_{thJC}$  Characteristics (Per Leg)

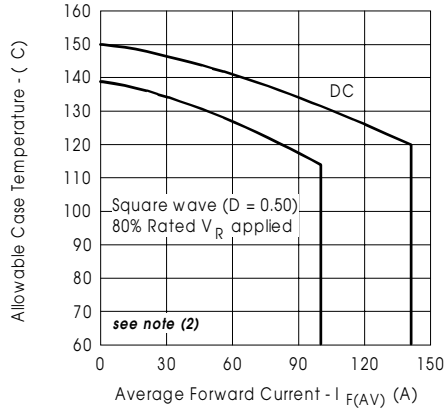

Fig. 5 - Max. Allowable Case Temperature Vs. Average Forward Current (Per Leg)

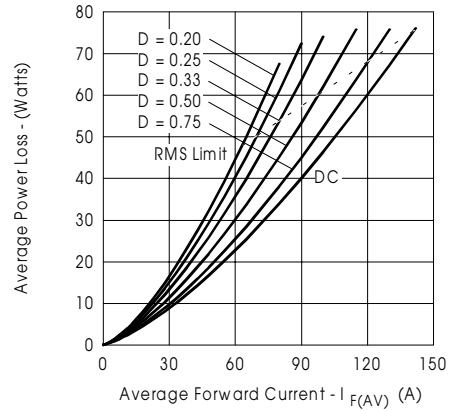

Fig. 6 - Forward Power Loss Characteristics (Per Leg)

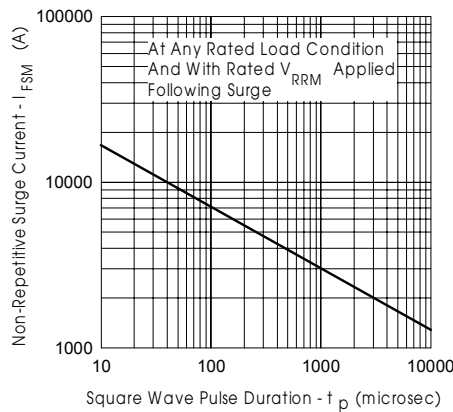

Fig. 7 - Max. Non-Repetitive Surge Current (Per Leg)

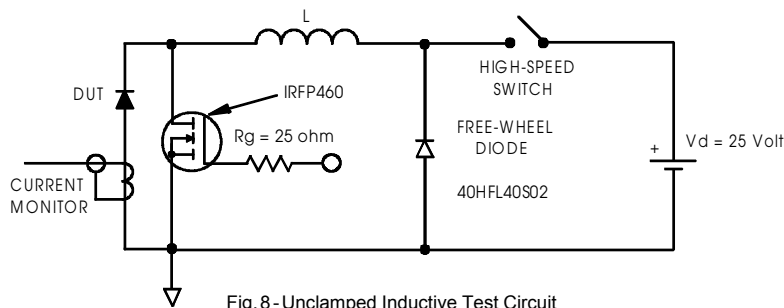

Fig. 8 - Unclamped Inductive Test Circuit

(2) Formula used:  $T_C = T_J - (P_d + P_{d_{REV}}) \times R_{thJC}$

$P_d$  = Forward Power Loss =  $I_{F(AV)} \times V_{FM} @ (I_{F(AV)}/D)$  (see Fig. 6);

$P_{d_{REV}}$  = Inverse Power Loss =  $V_{R1} \times I_{R1} (1-D)$ ;  $I_{R1} @ V_{R1} = 80\%$  rated  $V_R$

Data and specifications subject to change without notice.  
This product has been designed and qualified for Industrial Level.  
Qualification Standards can be found on IR's Web site.

International  
**IR** Rectifier

**IR WORLD HEADQUARTERS:** 233 Kansas St., El Segundo, California 90245, USA Tel: (310) 252-7105  
TAC Fax: (310) 252-7309  
Visit us at [www.irf.com](http://www.irf.com) for sales contact information. 07/01