

MITSUBISHI IGBT MODULES
CM100DU-24H
 HIGH POWER SWITCHING USE
 INSULATED TYPE

CM100DU-24H



- Ic 100A
- VCES 1200V
- Insulated Type
- 2-elements in a pack

APPLICATION

UPS, NC machine, AC-Drive control, Servo, Welders

OUTLINE DRAWING & CIRCUIT DIAGRAM

Dimensions in mm

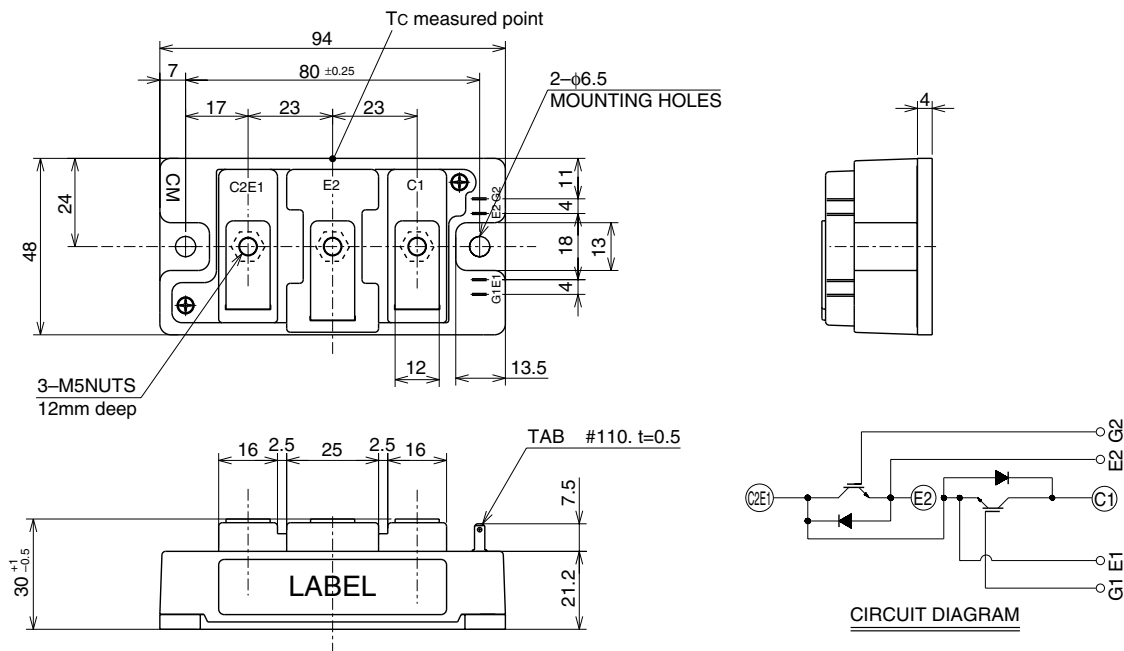

CM100DU-24H

HIGH POWER SWITCHING USE
INSULATED TYPEMAXIMUM RATINGS ($T_j = 25^\circ\text{C}$, unless otherwise specified)

Symbol	Item	Conditions	Ratings	Unit
VCES	Collector-emitter voltage	$V_{GE} = 0\text{V}$	1200	V
VGES	Gate-emitter voltage	$V_{CE} = 0\text{V}$	± 20	V
IC	Collector current	$T_C = 25^\circ\text{C}$	100	A
ICM		Pulse (Note 1)	200	A
IE (Note 2)	Emitter current	$T_C = 25^\circ\text{C}$	100	A
IEM (Note 2)		Pulse (Note 1)	200	A
PC (Note 3)	Maximum collector dissipation	$T_C = 25^\circ\text{C}$	650	W
Tj	Junction temperature	—	$-40 \sim +150$	$^\circ\text{C}$
Tstg	Storage temperature	—	$-40 \sim +125$	$^\circ\text{C}$
Viso	Isolation voltage	Charged part to base plate, $f = 60\text{Hz}$, AC 1 minute	2500	Vrms
—	Mounting torque	Main terminals M5 screw	2.5 ~ 3.5	N·m
—		Mounting M6 screw	3.5 ~ 4.5	N·m
—	Weight	Typical value	310	g

ELECTRICAL CHARACTERISTICS ($T_j = 25^\circ\text{C}$, unless otherwise specified)

Symbol	Item	Test Conditions	Limits			Unit
			Min	Typ	Max	
ICES	Collector cutoff current	$V_{CE} = V_{CES}$, $V_{GE} = 0\text{V}$	—	—	1	mA
VGE(th)	Gate-emitter threshold voltage	$I_C = 10\text{mA}$, $V_{CE} = 10\text{V}$	4.5	6	7.5	V
IGES	Gate-leakage current	$\pm V_{GE} = V_{GES}$, $V_{CE} = 0\text{V}$	—	—	0.5	μA
VCE(sat)	Collector-emitter saturation voltage	$I_C = 100\text{A}$, $V_{GE} = 15\text{V}$ (Note 4)	$T_j = 25^\circ\text{C}$ $T_j = 125^\circ\text{C}$	— 2.9 2.85	3.7 —	V
Cies	Input capacitance	$V_{CE} = 10\text{V}$	—	—	15	nF
Coes	Output capacitance	$V_{GE} = 0\text{V}$	—	—	5	nF
Cres	Reverse transfer capacitance	—	—	—	3	nF
QG	Total gate charge	$V_{CC} = 600\text{V}$, $I_C = 100\text{A}$, $V_{GE} = 15\text{V}$	—	375	—	nC
td(on)	Turn-on delay time	$V_{CC} = 600\text{V}$, $I_C = 100\text{A}$	—	—	100	ns
tr	Turn-on rise time	$V_{GE} = \pm 15\text{V}$	—	—	200	ns
td(off)	Turn-off delay time	$R_G = 3.1\Omega$	—	—	300	ns
tf	Turn-off fall time	Resistive load	—	—	350	ns
VEC(Note 2)	Emitter-collector voltage	$I_E = 100\text{A}$, $V_{GE} = 0\text{V}$	—	—	3.2	V
t _{rr} (Note 2)	Reverse recovery time	$I_E = 100\text{A}$,	—	—	300	ns
Q _{rr} (Note 2)	Reverse recovery charge	$di_e / dt = -200\text{A} / \mu\text{s}$	—	0.55	—	μC
Rth(j-c)Q	Thermal resistance (Note 5)	Junction to case, IGBT part (Per 1/2 module)	—	—	0.19	K/W
Rth(j-c)R		Junction to case, FWDi part (Per 1/2 module)	—	—	0.35	K/W
Rth(c-f)	Contact thermal resistance	Case to heat sink, conductive grease applied (Per 1/2 module) (Note 6)	—	0.07	—	K/W

Note 1. Pulse width and repetition rate should be such that the device junction temperature (T_j) does not exceed T_{jmax} rating.

2. I_E , V_{EC} , t_{rr} , Q_{rr} & di_e/dt represent characteristics of the anti-parallel, emitter-collector free-wheel diode.

3. Junction temperature (T_j) should not increase beyond 150°C .

4. Pulse width and repetition rate should be such as to cause negligible temperature rise.

5. Case temperature (T_c) measured point is shown in page OUTLINE DRAWING.

6. Typical value is measured by using thermally conductive grease of $\lambda = 0.9[\text{W}/(\text{m} \cdot \text{K})]$.

CM100DU-24H

HIGH POWER SWITCHING USE
INSULATED TYPE

PERFORMANCE CURVES

OUTPUT CHARACTERISTICS (TYPICAL)

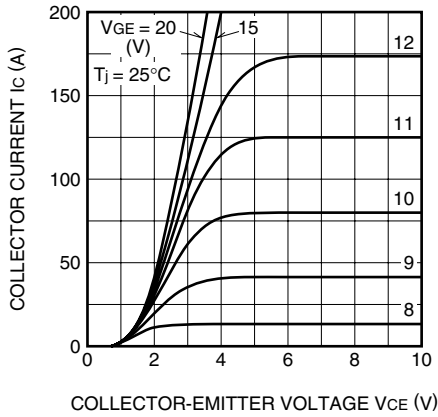

TRANSFER CHARACTERISTICS (TYPICAL)

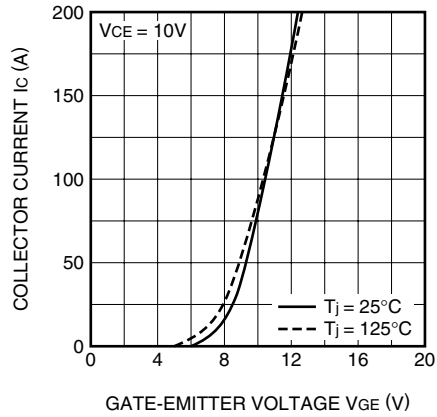

COLLECTOR-EMITTER SATURATION VOLTAGE CHARACTERISTICS (TYPICAL)

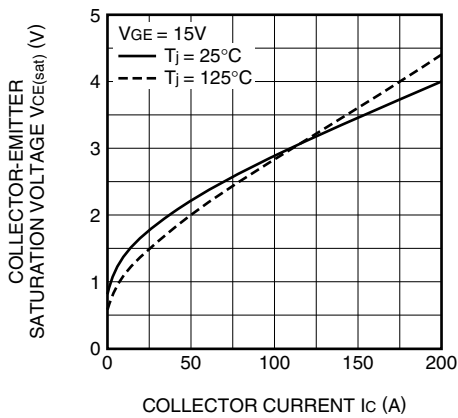

COLLECTOR-EMITTER SATURATION VOLTAGE CHARACTERISTICS (TYPICAL)

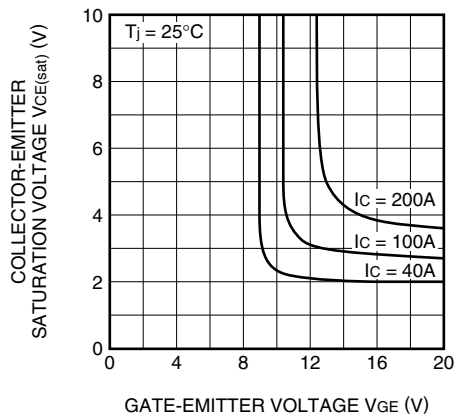

FREE-WHEEL DIODE FORWARD CHARACTERISTICS (TYPICAL)

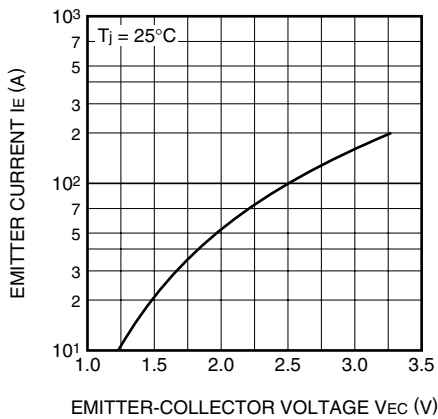

CAPACITANCE CHARACTERISTICS (TYPICAL)

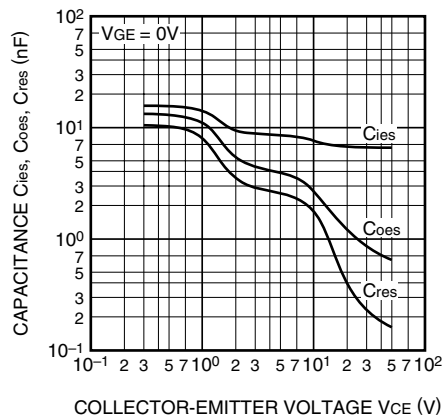

CM100DU-24H

HIGH POWER SWITCHING USE
INSULATED TYPE

HALF-BRIDGE SWITCHING TIME CHARACTERISTICS (TYPICAL)

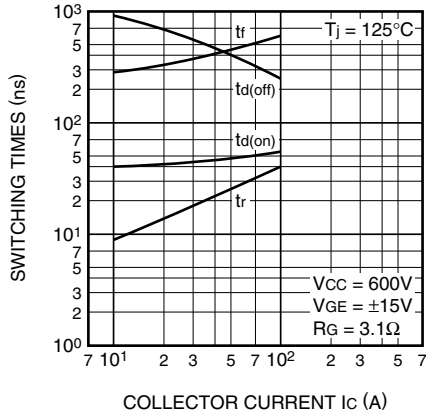

REVERSE RECOVERY CHARACTERISTICS OF FREE-WHEEL DIODE (TYPICAL)

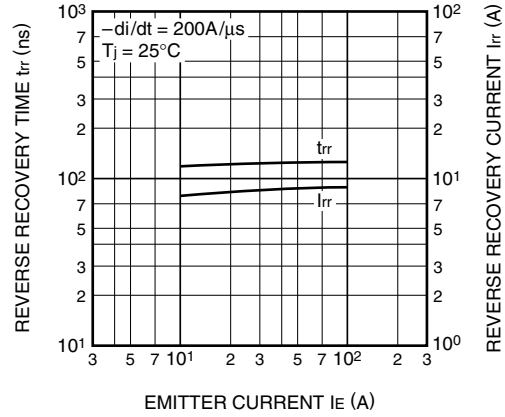

TRANSIENT THERMAL IMPEDANCE CHARACTERISTICS (IGBT part)

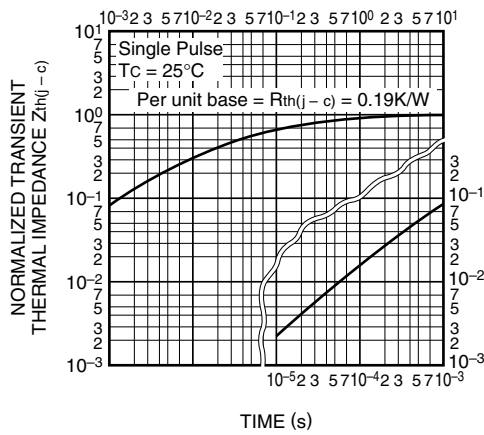

TRANSIENT THERMAL IMPEDANCE CHARACTERISTICS (FWDi part)

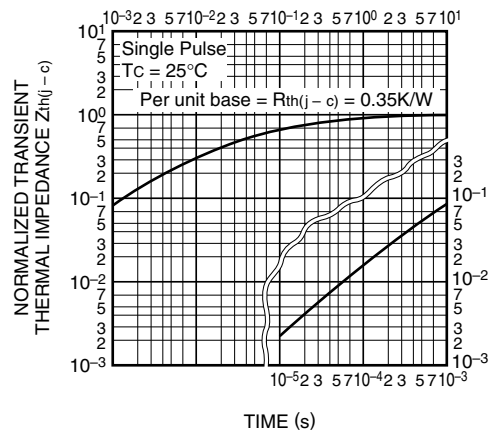

GATE CHARGE CHARACTERISTICS (TYPICAL)

