

SPECIFICATION

Device Name : IGBT module

Type Name : 2MBI150NT-120-01

Spec. No. : **MS5F3937**

This manual and the information herein is the property of Fuji Electric Co. Ltd. They shall be neither reproduced, copied, loaned, or disclosed in any way whatsoever for the use of any third party or used for the manufacturing purposes without the express written consent of Fuji Electric Co., Ltd.

Fuji Electric Co., Ltd.
Matsumoto Factory

	DATE	NAME	APPROVED	
DRAWN:	Feb -21-97	J. Kobayashi	S.K.	Fuji Electric Co., Ltd.
CHECKED:	Feb -21-97	S. Muroga		
				DWG. NO. MS5F3937
				1/7 a

Revised Records

Date	Classi- fication	Ind.	Content	Applied date	Drawn	Checked	Approved
Feb. 21, '97	enactment	—	—————	Issued date	—	S. Miyazaki	S. K.
Apr. 18, '97	Revision	a	P5/17 Revers gate bias voltage		J. Kobayashi	A. Miyazaki	S. K.

This material and the information herein is the property of
 Fuji Electric Co., Ltd. It shall be neither reproduced, copied,
 lent, or disclosed in any way whatsoever for the use of any
 third party without the written consent of Fuji Electric Co., Ltd.

Fuji Electric Co., Ltd.

DWG. NO.

MS5 F 3937

2/7

01

2MBI150NT-120-01

1. Outline Drawing
Unit : mm

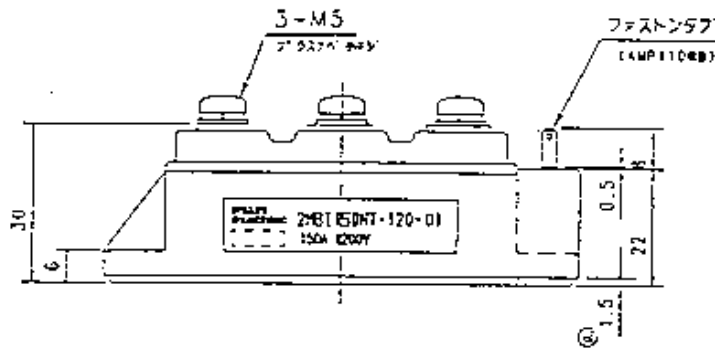
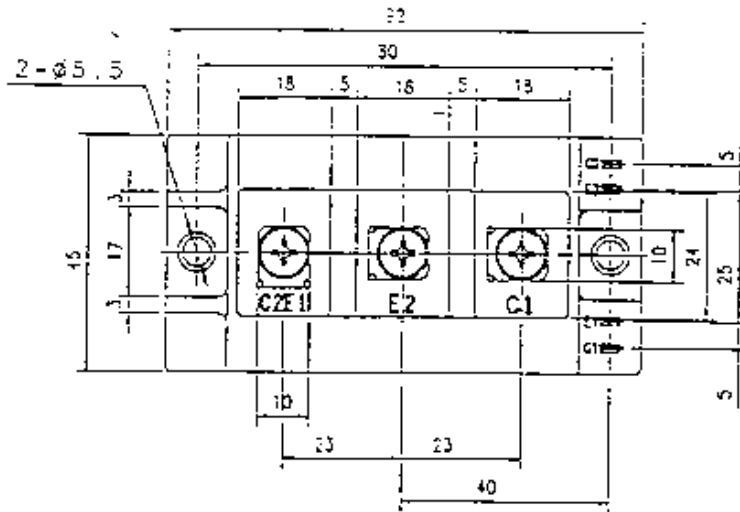

This material and the information herein is the property of Fuji Electric Co., Ltd. They shall be neither reproduced, copied, lent, or disclosed in any way whatsoever for the use of any third party nor used for the manufacturing purposes without the express written consent of Fuji Electric Co., Ltd.

2. Equivalent circuit

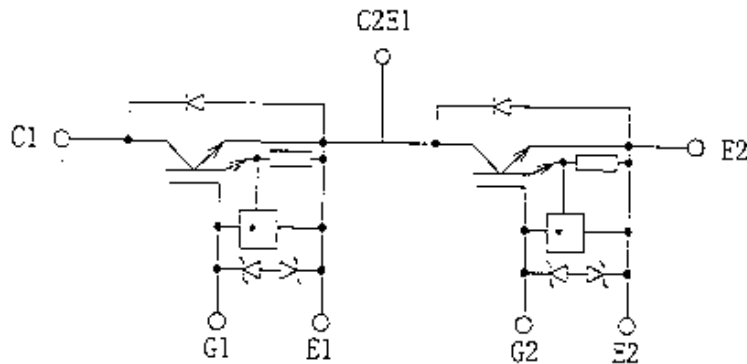

* NLU (Over Current Limiting Circuit)

3. Absolute Maximum Ratings (at $T_c=25^\circ\text{C}$ unless otherwise specified)

Items	Symbols	Ratings	Units
Collector-Emitter voltage	V_{CES}	1200	V
Gate-Emitter voltage	V_{GES}	± 20	V
Collector current	Continuous	I_C	150
	1ms	I_C pulse	300
		$-I_C$	150
	1ms	$-I_C$ pulse	300
Max. power dissipation	PC	1210	W
Operating temperature	T_j	+150	$^\circ\text{C}$
Storage temperature	T_{stg}	-40~+125	$^\circ\text{C}$
Isolation voltage	V_{is}	AC 2500 (1min.)	V
Screw torque	Mounting *1	3.5	N·m
	Terminals *2	4.5	

Note : *1 Recommendable value : 2.5~3.5 N·m (M5) or (M6)

*2 Recommendable value : 3.5~4.5 N·m (M6)

4. Electrical characteristics (at $T_j=25^\circ\text{C}$ unless otherwise specified)

Items	Symbols	Characteristics			Conditions	Units
		min.	typ.	max.		
Zero gate voltage Collector current	I_{CES}			2.0	$V_{GE}=0V, V_{CE}=1200V$	mA
Gate-Emitter leakage current	I_{GES}			30	$V_{CE}=0V, V_{GE}=\pm 20V$	μA
Gate-Emitter threshold voltage	$V_{GE(th)}$	4.5		7.5	$V_{CE}=20V, I_C=150\text{mA}$	V
Collector-Emitter saturation voltage	$V_{CE(sat)}$			3.5	$V_{GE}=15V, I_C=150A$	V
Input capacitance	C_{ies}		27000		$V_{GE}=0V$ $V_{CE}=10V$ $f=1\text{MHz}$	μF
Output capacitance	C_{oes}		12500			
Reverse transfer capacitance	C_{res}		10000			
Turn-on time	t_{on}		0.65	1.2	$V_{CC}=600V$ $I_C=150A$	μs
	t_r		0.25	0.6		
Turn-off time	t_{off}		0.85	1.5	$V_{GE}=\pm 15V$ $R_G=5.6\Omega$	
	t_f		0.35	0.5		
Diode forward on voltage	V_F			3.4	$I_F=150A, V_{GE}=0V$	V
Reverse recovery time	t_{rr}			350	$I_F=150A$	ns
Short-circuit withstand capability	P_w	10			$V_{CC}=800V, V_{GE}=-15V$ $R_G=2.7\Omega$	μs

5. Thermal resistance characteristics

Items	Symbols	Characteristics			Conditions	Units
		min.	typ.	max.		
Thermal resistance	$R_{th(j-c)}$			0.10	IGBT	$^\circ\text{C/W}$
	$R_{th(j-c)}$			0.30	Diode	
	※		0.025		the base to cooling	
	$R_{th(c-f)}$				fin	

※ This is the value which is defined mounting on the additional cooling fin with thermal compound.

This material and the information herein is the property of Fuji Electric Co. Ltd. They shall be neither reproduced, copied, lent, or disclosed in any way whatsoever for the use of any third party nor used for the manufacturing purposes without the express written consent of Fuji Electric Co. Ltd.

Fuji Electric Co., Ltd.

DWG NO.

MS5F3937

4/7

H04-004-03

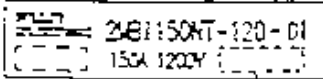

Lot No.

Place of manufacturing (code)

7. Applicable category (適用範囲)

This specification is applied to IGBT module named 2MB150NT-120-01.
本納入仕様書は、IGBTモジュール2MB150NT-120-01に適用する。

8. Storage and transportation notes (保管、運搬上の注意事項)

- ・ The IGBT module should be stored at a standard temperature of 5 to 35°C and humidity of 45 to 75%.
常温保管が望ましい。(5~35°C、45~75%)
- ・ Store modules in a place with few temperature changes in order to avoid condensation on the module surface.
急激な温度変化の無きこと。(モジュール表面が結露しないこと)
- ・ Avoid exposure to corrosive gases and dust.
腐蝕性ガスの発生場所、塵埃の多い場所は避けること。
- ・ Avoid excessive external force on the module.
製品に荷重がかからないように十分注意すること。
- ・ Store modules with unprocessed terminals.
モジュールの端子は未加工の状態で保管すること。
- ・ Do not drop or otherwise shock the modules when transporting.
製品の運搬時に衝撃を与えたり、落下させたりしないこと。

9. Heat sink mounting notes (ヒートシンク取り付け上の注意事項)

- ・ The mounting surface of the heat sink should be finished to a roughness of 10 μ m or less and a warp between screw holes of 100 μ m or less.
本モジュールを取り付ける冷卻体の取付面の仕上げは、粗さ10 μ m以下、取付ネジ間で平坦度100 μ m以下とする。
- ・ Each mounting screw should be fastened using a specified torque after pre-fastening using a 1/3 specified torque.
取付けネジは、規定の1/3のトルクで仮締を行った後、規定のトルクで本締を行って下さい。
- ・ If the above notes are not met, it has a possibility to break the insulation between the IGBT module's chips and metal base.
上記注意事項の範囲外で御運用した場合、IGBTモジュールのチップと金属ベース間の絶縁破壊を生ずる可能性があります。

⑩ 10. Revers gate bias voltage (ゲート逆バイアス電圧)

- ① Recommendable value of the revers gate bias voltage : -7V(typ.), -5V(min.) R θ =5.6 Ω
ゲート逆バイアス電圧の推奨値 : -7V(typ.), -5V(min.) R θ =5.6 Ω
- ② The revers gate bias voltage means the voltage between the gate terminal and the auxiliary emitter terminal of the modules.
ゲート逆バイアス電圧は、モジュールのゲート端子と補助エミッタ端子間の電圧である。

Fuji Electric Co., Ltd.

DWG NO.

MS5F3937

5/7

H04-004-03

The position and the information here is the property of Fuji Electric Co., Ltd. They shall be neither reproduced, copied, lent, or disclosed in any way whatsoever for the use of any individual not used for the manufacturing purposes without the express written consent of Fuji Electric Co., Ltd.

This material and the information herein is the property of Fuji Electric Co., Ltd. It shall be neither reproduced, copied, sent, or disclosed in any way whatsoever for the use of any individual, partnership, or corporation for the manufacturing purposes without the express written consent of Fuji Electric Co., Ltd.

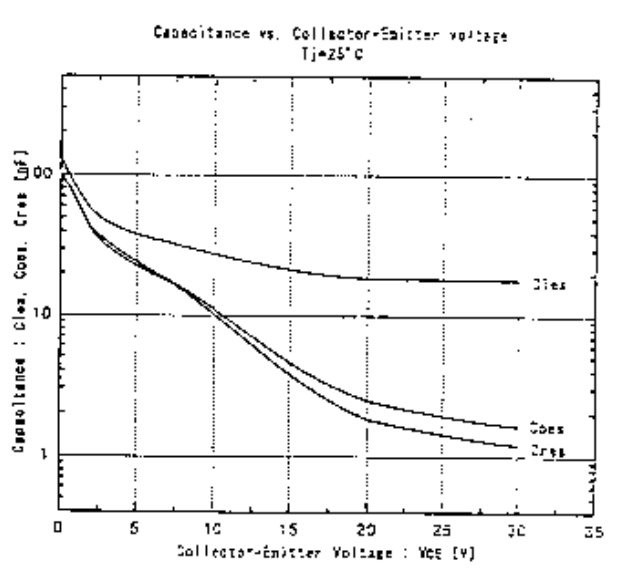
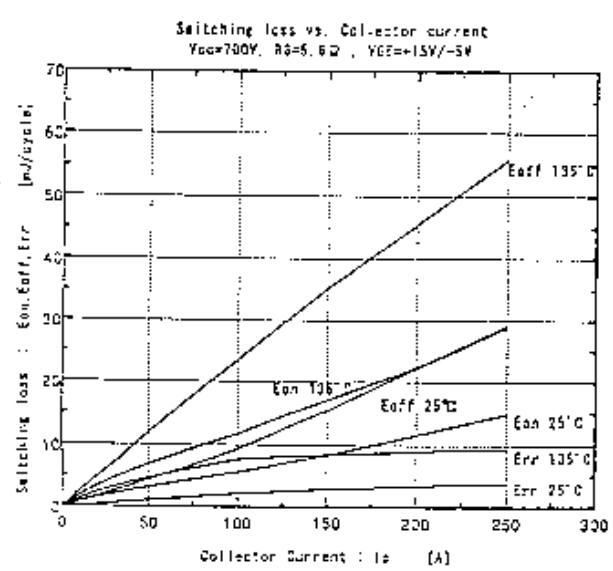
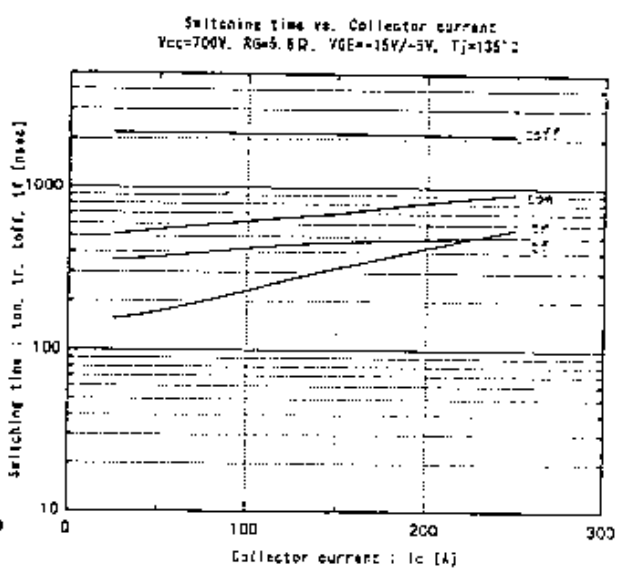
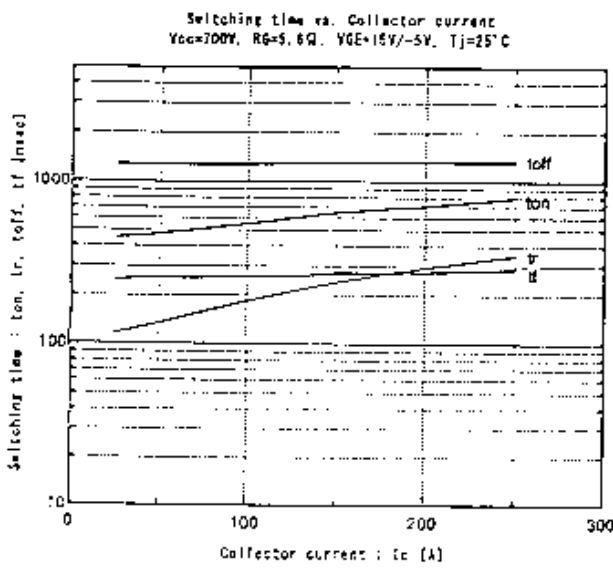
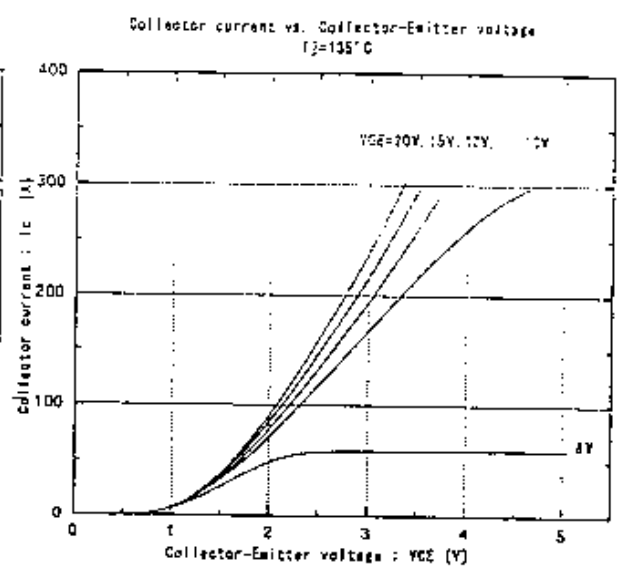
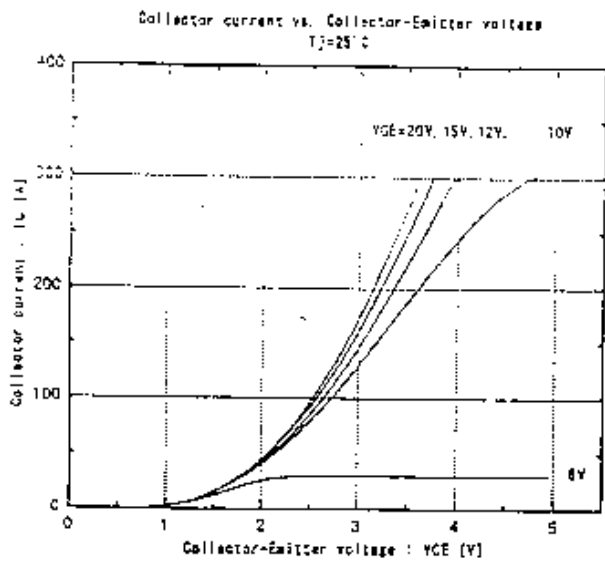

Fuji Electric Co., Ltd.

DWG. NO.

MS5F3937

6/7

This material and the information herein is the property of Fuji Electric Co., Ltd. They shall be neither reproduced, copied, lent, or disclosed in any way whatsoever for the use of any third party nor used for the manufacturing purposes without the express written consent of Fuji Electric Co., Ltd.

Switching time vs. R_G
 $V_{CC}=700V, I_C=150A, V_{GE}=+15V/-5V, T_J=25^\circ C$

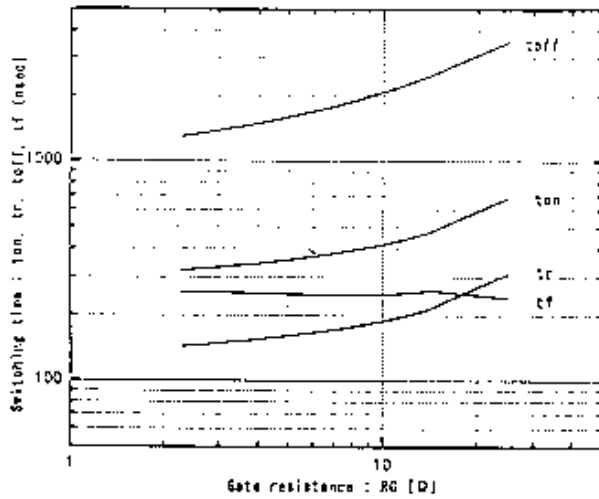

Dynamic input characteristics
 $T_J=25^\circ C$

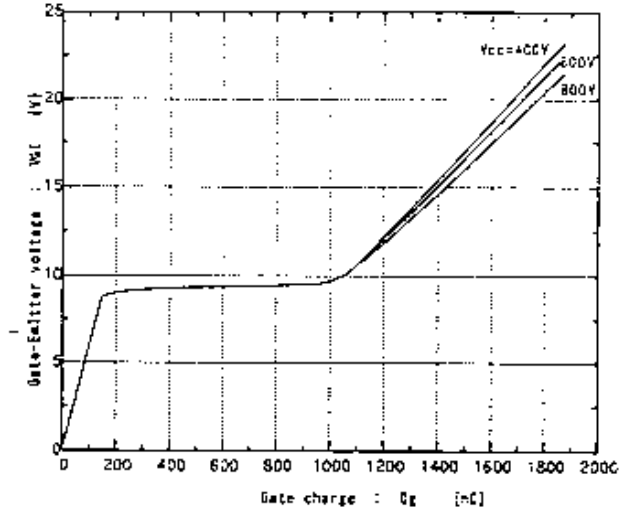

Forward current vs. Forward voltage
 $V_{GE}=0V$

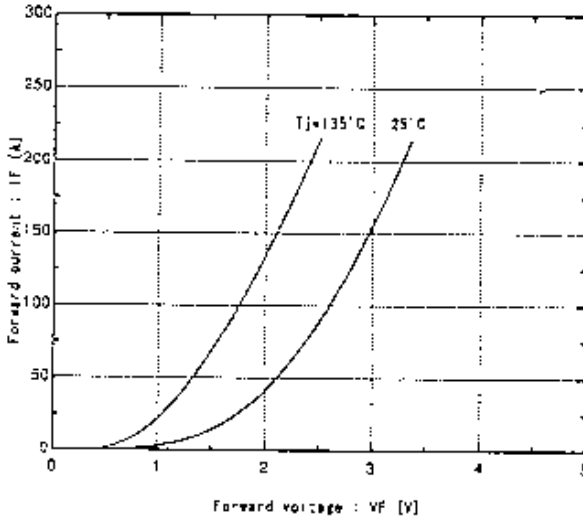

Reverse recovery characteristics
 I_{rr}, t_{rr} vs. I_F

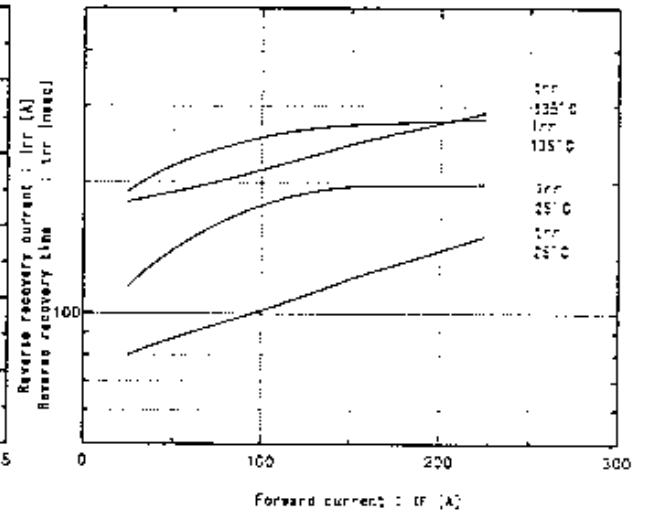

Transient thermal resistance

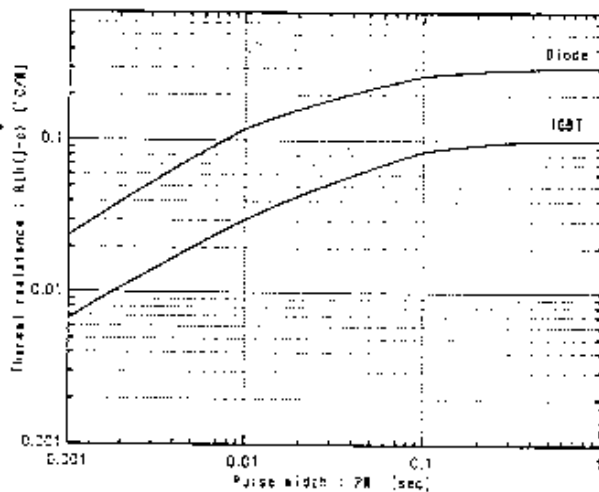

Reversed biased safe operating area
 $+V_{GE}=15V, -V_{GE}\leq 15V, T_J\leq 105^\circ C$

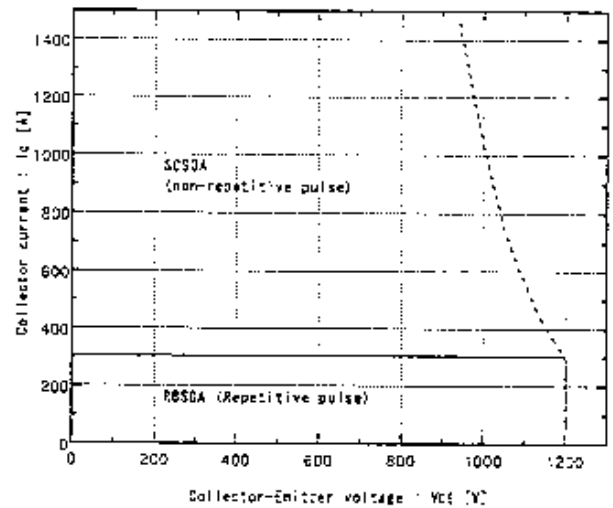

Fuji Electric Co., Ltd.

DWS/RO

MS5F3937

7/1

100-324-03