

IGBT MODULE (U series) 600V / 50A / PIM



■ Features

- Low $V_{CE(sat)}$
- Compact Package
- P.C. Board Mount Module
- Converter Diode Bridge Dynamic Brake Circuit

■ Applications

- Inverter for Motoe Drive
- AC and DC Servo Drive Amplifier
- Uninterruptible Power Supply

■ Maximum ratings and characteristics

● Absolute maximum ratings ($T_c=25^\circ\text{C}$ unless otherwise specified)

Item	Symbol	Condition	Rating	Unit	
Inverter	Collector-Emitter voltage	V_{CES}	600	V	
	Gate-Emitter voltage	V_{GES}	± 20	V	
	Collector current	I_C	Continuous	50	A
		I_{CP}	1ms	100	
		$-I_C$		50	
$-I_C$ pulse		1ms	100		
Collector power dissipation	P_C	1 device	187	W	
Brake	Collector-Emitter voltage	V_{CES}	600	V	
	Gate-Emitter voltage	V_{GES}	± 20	V	
	Collector current	I_C	Continuous	20	A
		I_{CP}	1ms	40	A
	Collector power dissipation	P_C	1 device	104	W
Repetitive peak reverse voltage	V_{RRM}		600	V	
Converter	Repetitive peak reverse voltage	V_{RRM}	800	V	
	Average output current	I_b	50Hz/60Hz sine wave	50	A
	Surge current (Non-Repetitive)	I_{FSM}	$T_j=150^\circ\text{C}$, 10ms	350	A
	I^2t (Non-Repetitive)	I^2t	half sine wave	613	A^2s
Operating junction temperature	T_j		+150	$^\circ\text{C}$	
Storage temperature	T_{stg}		-40 to +125	$^\circ\text{C}$	
Isolation voltage	between terminal and copper base *2 between thermistor and others *3	V_{iso}	AC : 1 minute	AC 2500	V
				AC 2500	
Mounting screw torque			3.5 *1	N·m	

*1 Recommendable value : 2.5 to 3.5 N·m (M5)

*2 All terminals should be connected together when isolation test will be done.

*3 Two thermistor terminals should be connected together, each other terminals should be connected together and shorted to base plate when isolation test will be done.

● Electrical characteristics (Tj=25°C unless otherwise specified)

Item	Symbol	Condition	Characteristics			Unit			
			Min.	Typ.	Max.				
Inverter	Zero gate voltage collector current	ICES	VCE=600V, VGE=0V			-	mA		
	Gate-Emitter leakage current	IGES	VCE=0V, VGE=±20V			-	nA		
	Gate-Emitter threshold voltage	VGE(th)	VCE=20V, Ic=50mA			6.2	6.7	7.7	V
	Collector-Emitter saturation voltage	VCE(sat) (terminal)	VGE=15V Ic=50A	Tj=25°C	-	2.25	2.55	V	
				Tj=125°C	-	2.45	-		
		VCE(sat) (chip)	Tj=25°C	-	1.85	-			
			Tj=125°C	-	2.15	-			
	Input capacitance	Cies	VGE=0V, VCE=10V, f=1MHz			-	3.6	-	nF
	Turn-on time	ton	VCC=300V			-	0.42	1.20	µs
		tr	Ic=50A			-	0.24	0.60	
		tr(i)	VGE=±15V			-	0.05	-	
	Turn-off time	toff	RG=68Ω			-	0.42	1.20	µs
		tf				-	0.03	0.45	
	Forward on voltage	VF (terminal)	VGE=0V IF=50A	Tj=25°C	-	2.00	2.35	V	
Tj=125°C				-	2.05	-			
VF (chip)		Tj=25°C	-	1.60	-				
		Tj=125°C	-	1.65	-				
Reverse recovery time	trr	IF=50A			-	-	0.35	µs	
Brake	Zero gate voltage collector current	ICES	VCE=600V, VGE=0V			-	-	1.0	mA
	Gate-Emitter leakage current	IGES	VCE=0V, VGE=±20V			-	-	200	nA
	Collector-Emitter saturation voltage	VCE(sat) (terminal)	Ic=20A VGE=15V	Tj=25°C	-	1.85	2.15	V	
				Tj=125°C	-	2.15	-		
		VCE(sat) (chip)	Tj=25°C	-	1.70	-			
			Tj=125°C	-	2.00	-			
	Turn-on time	ton	VCC=300V			-	0.45	1.20	µs
		tr	Ic=20A			-	0.15	0.60	
	Turn-off time	toff	VGE=±15V			-	0.37	1.20	µs
		tf	RG=270Ω			-	0.04	0.45	
	Reverse current	IRRM	VR=600V			-	-	1.0	mA
	Converter	Forward on voltage	IF=50A VGE=0V	terminal	-	1.20	1.50	V	
				chip	-	1.10	-		
	Reverse current	IRRM	VR=800V			-	-	1.0	mA
Thermistor	Resistance	R	T=25°C			-	5000	-	Ω
			T=100°C			465	495	520	
B value	B	T=25/50°C			3305	3375	3450	K	

● Thermal resistance Characteristics

Item	Symbol	Condition	Characteristics			Unit
			Min.	Typ.	Max.	
Thermal resistance (1 device)	Rth(j-c)	Inverter IGBT	-	-	0.67	°C/W
		Inverter FWD	-	-	1.10	
		Brake IGBT	-	-	1.20	
		Converter Diode	-	-	0.82	
Contact thermal resistance *	Rth(c-f)	With thermal compound	-	0.05	-	

* This is the value which is defined mounting on the additional cooling fin with thermal compound

■ Equivalent Circuit Schematic

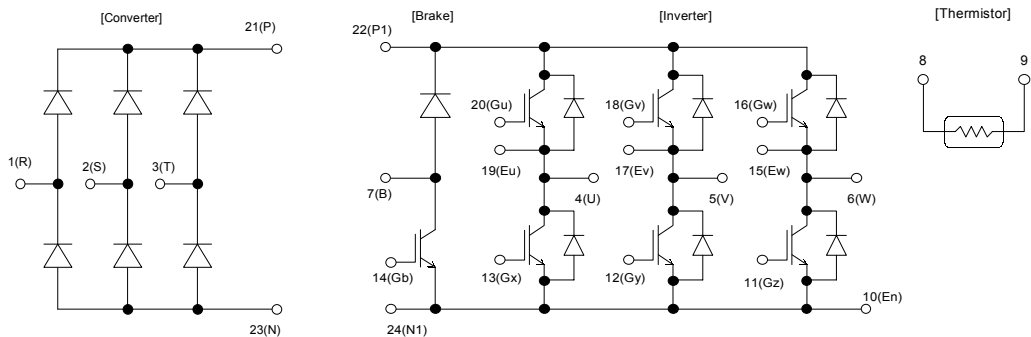

■ Characteristics (Representative)

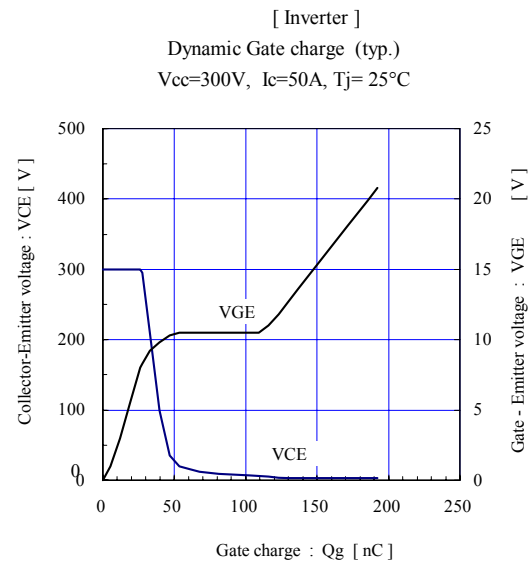
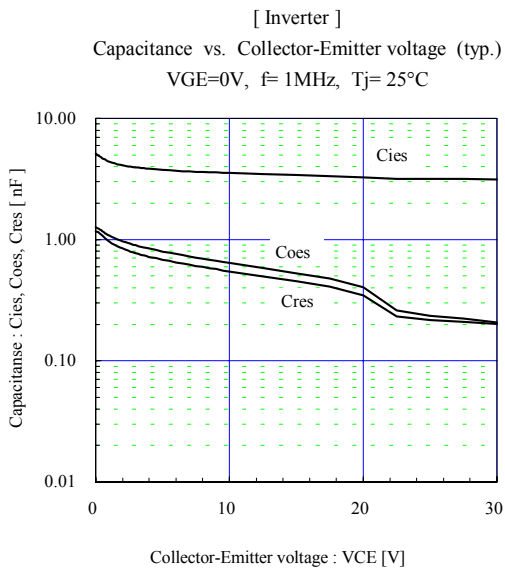
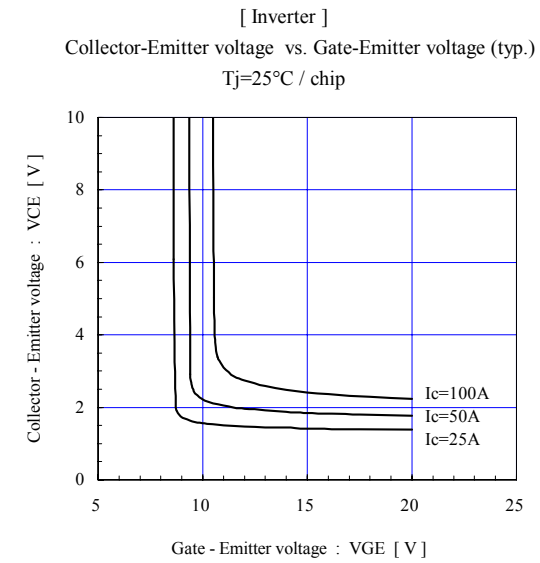
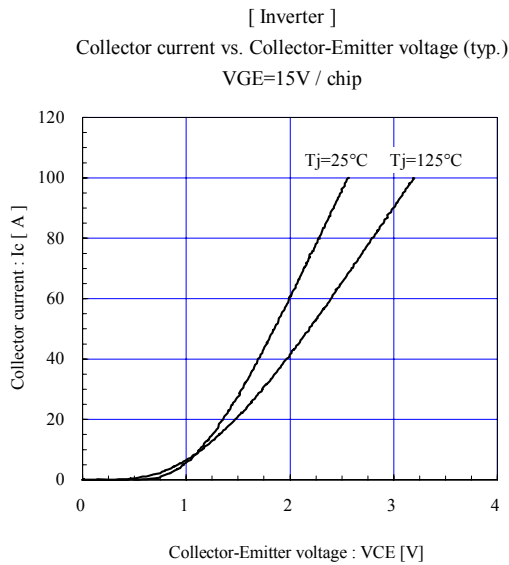
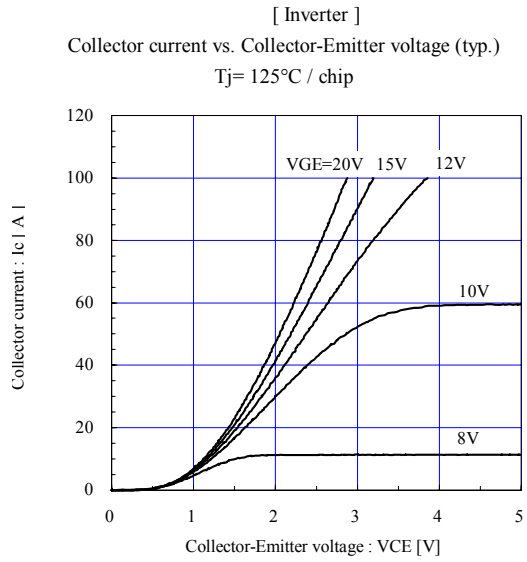
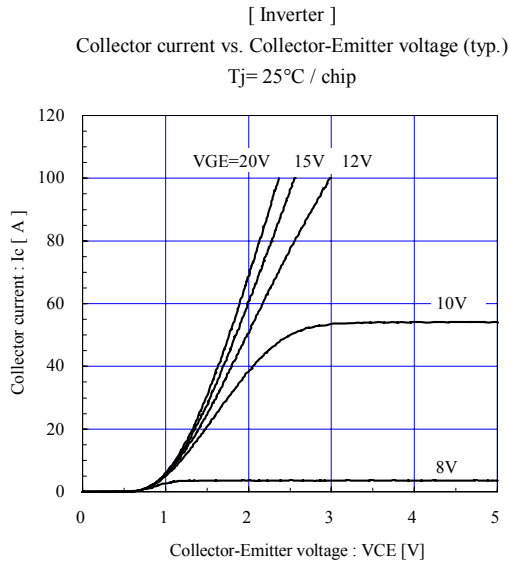

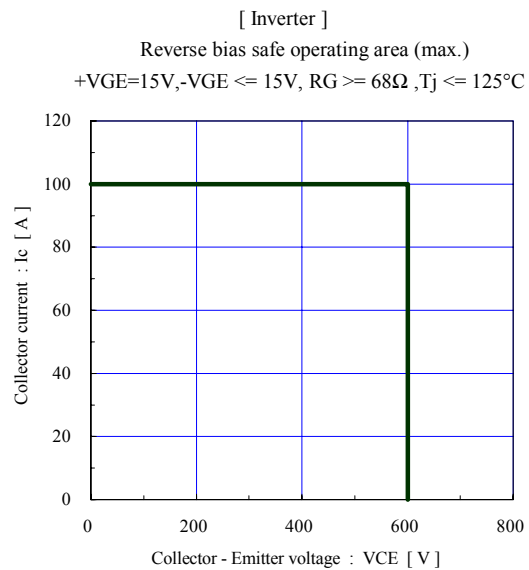
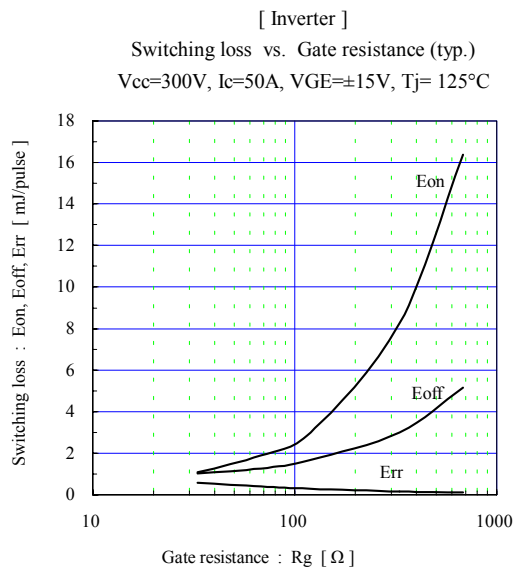
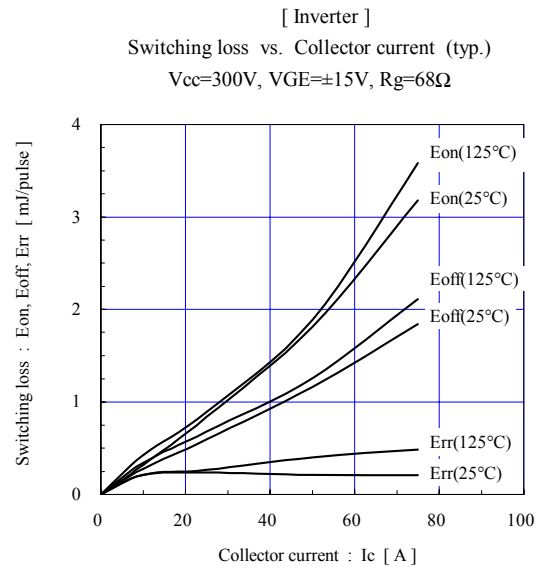
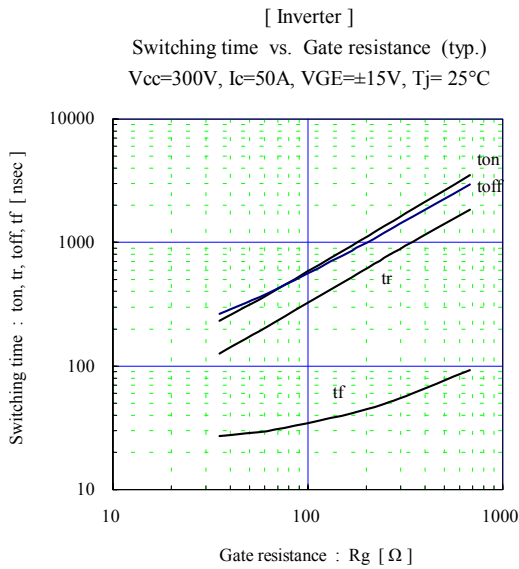
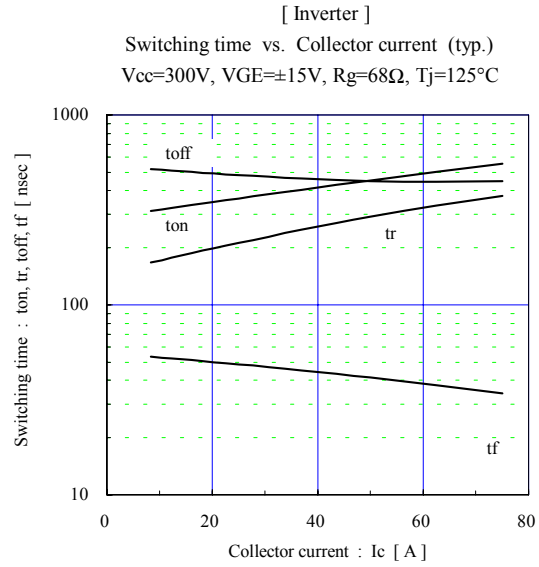
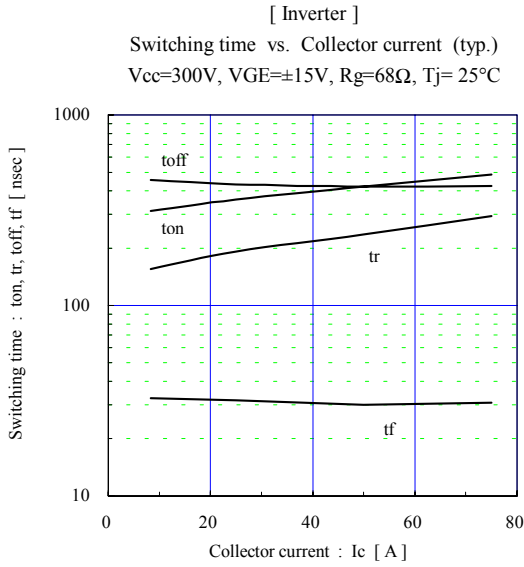

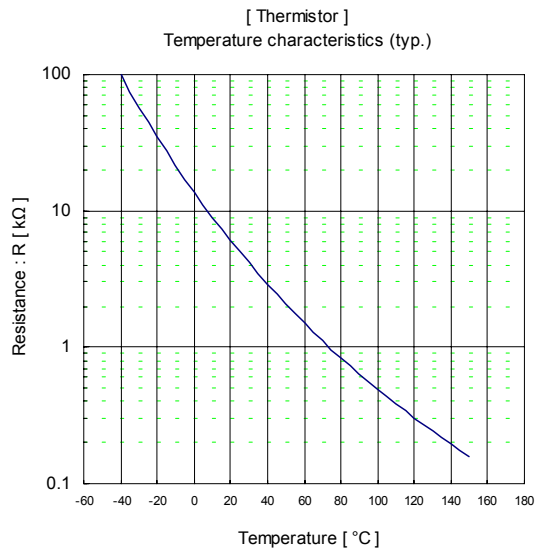
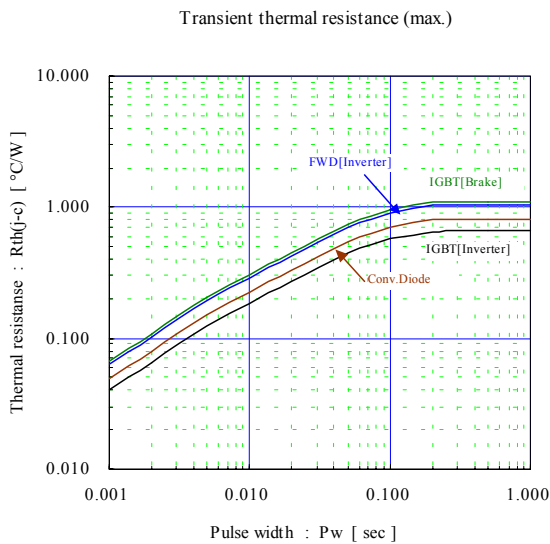
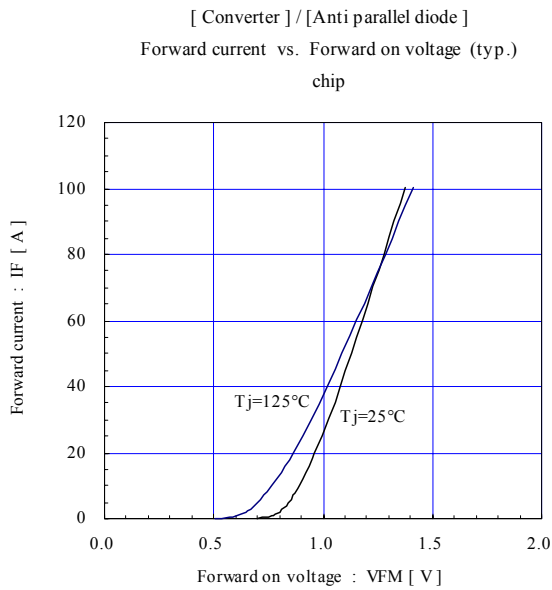
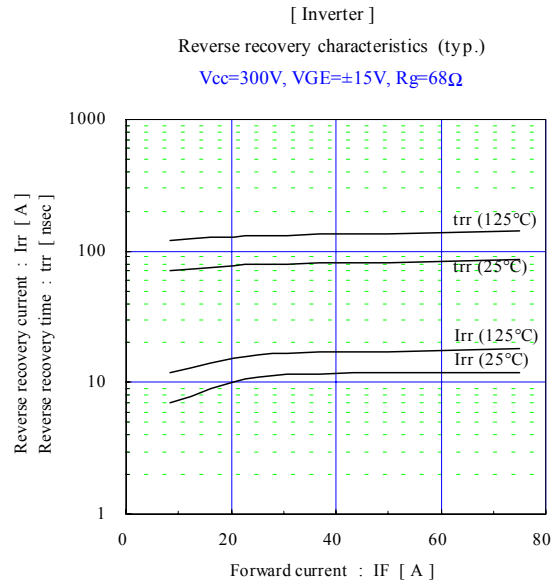
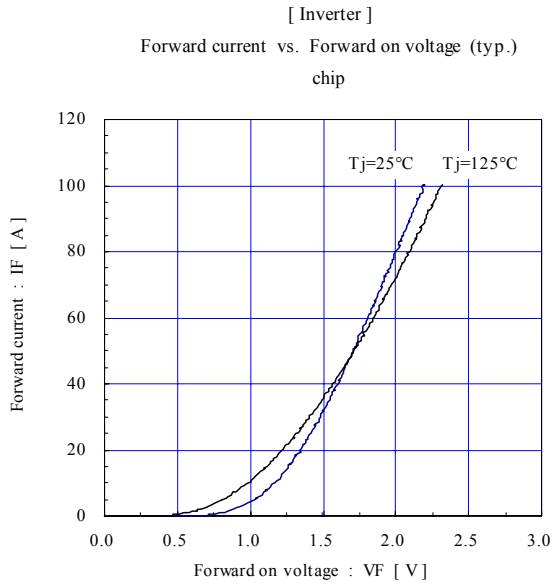

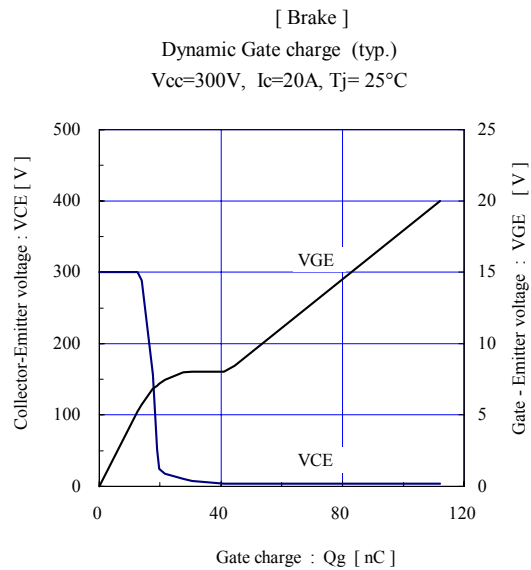
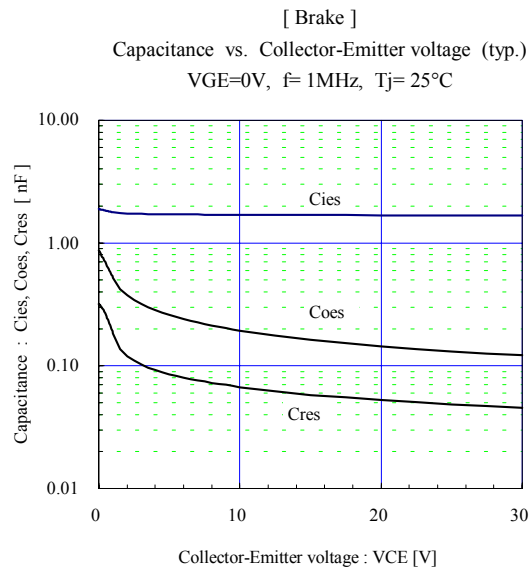
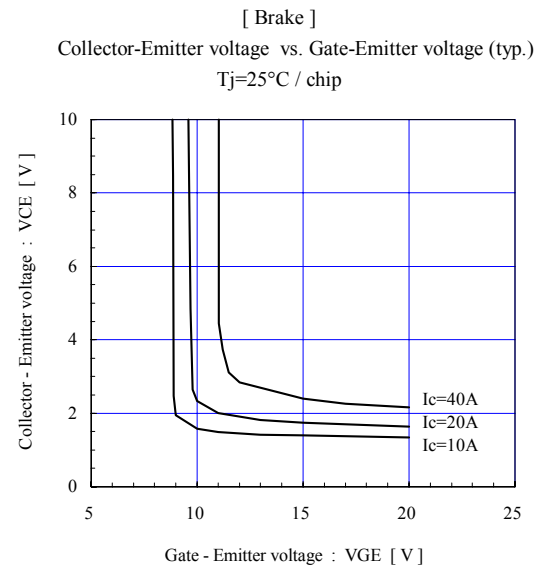
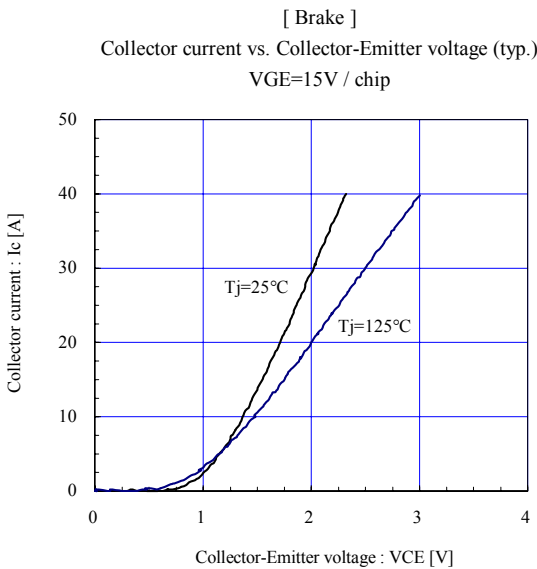
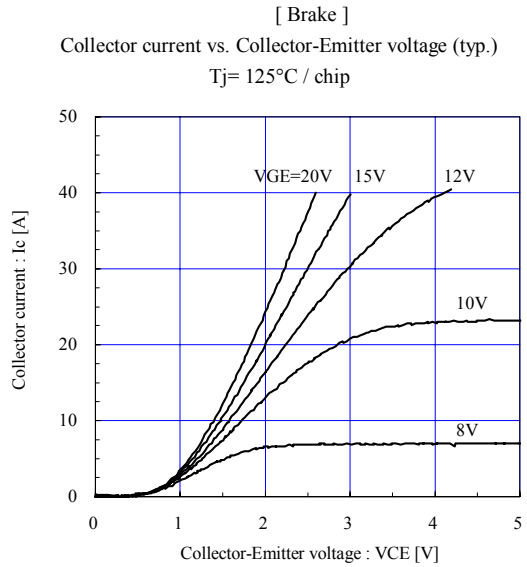
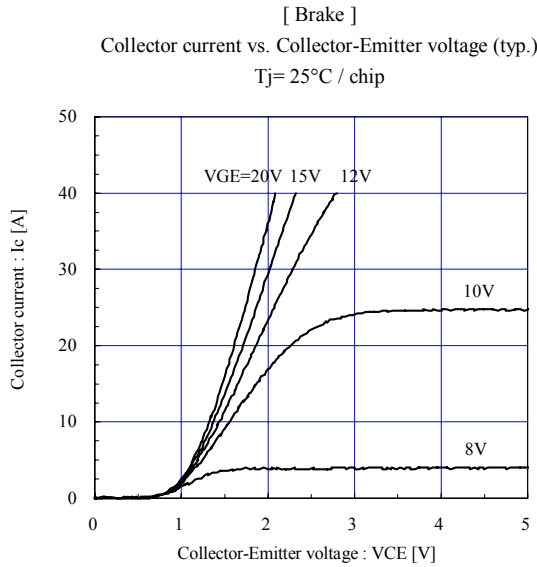

■ Outline Drawings, mm

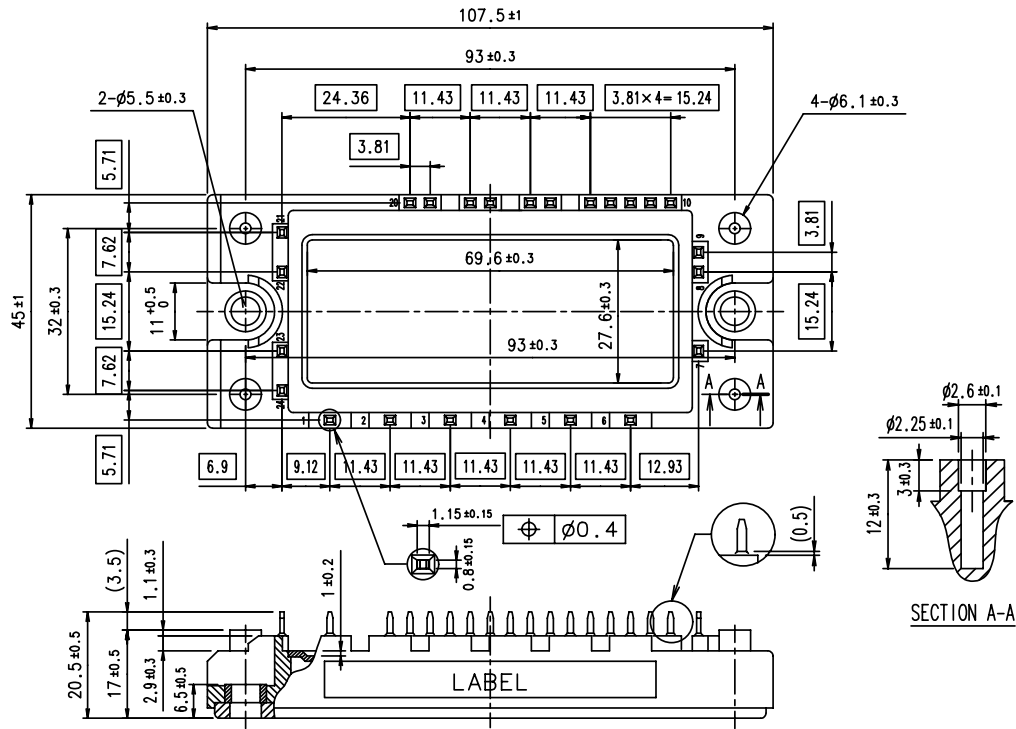

□ shows theoretical dimension.
 () shows reference dimension.