

MIG75J7CSB1W (600V/75A 7in1)

High Power Switching Applications
 Motor Control Applications

- Integrates inverter, brake power circuit and control circuits (IGBT drive units, and units for protection against short-circuit current, over-current, under-voltage and over-temperature) into a single package.
- The electrodes are isolated from the case
- Low thermal resistance
- $V_{CE(sat)} = 1.8\text{ V (typ.)}$
- UL recognized: File No.E87989
- Weight: 278 g (typ.)

Equivalent Circuit

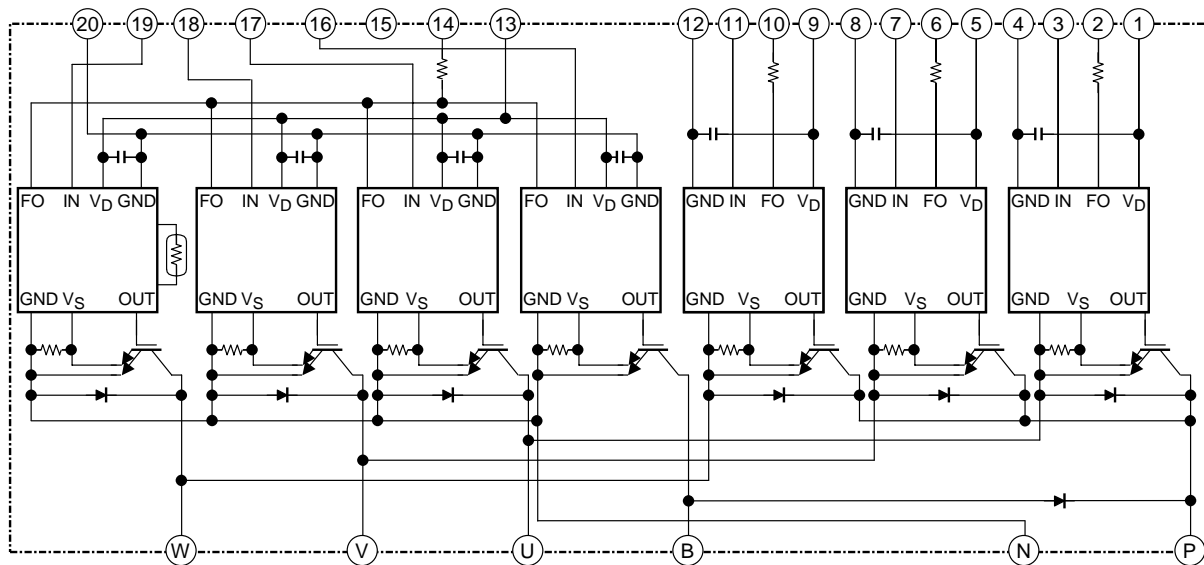

- | | | | | | | |
|--------------|--------------|------------|------------|--------------|---------------|------------|
| 1. V_D (U) | 2. FO (U) | 3. IN (U) | 4. GND (U) | 5. V_D (V) | 6. FO (V) | 7. IN (V) |
| 8. GND (V) | 9. V_D (W) | 10. FO (W) | 11. IN (W) | 12. GND (W) | 13. V_D (L) | 14. FO (L) |
| 15. Open | 16. IN (B) | 17. IN (X) | 18. IN (Y) | 19. IN (Z) | 20. GND (L) | |

Package Dimensions: TOSHIBA 2-108G1A

Unit: mm

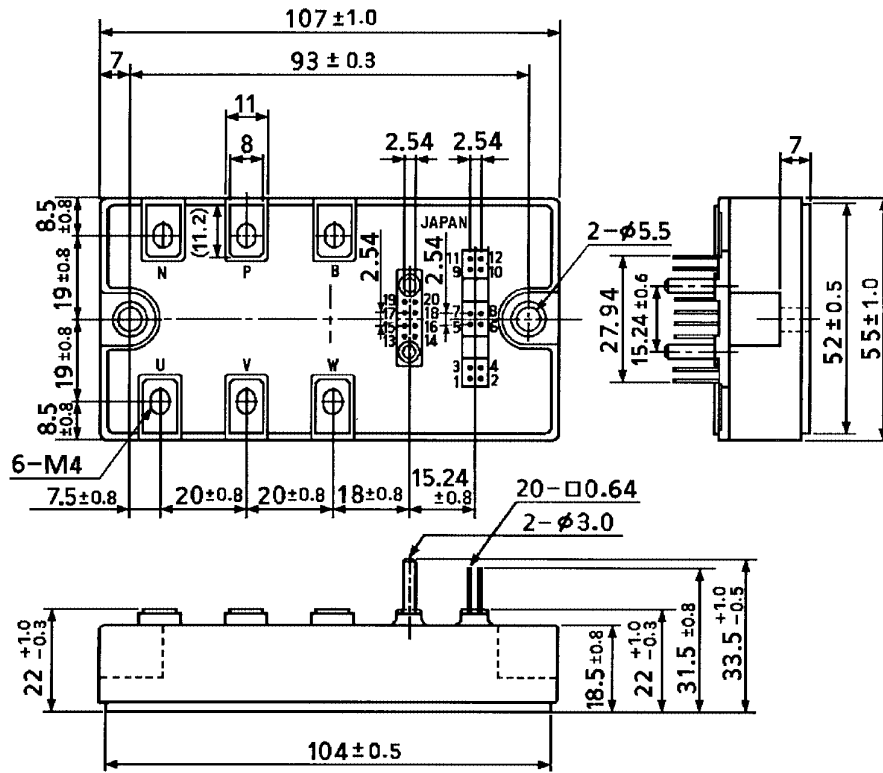

- | | | | | | |
|---------------|-------------|--------------|------------|--------------|-------------|
| 1. V_D (U) | 2. FO (U) | 3. IN (U) | 4. GND (U) | 5. V_D (V) | 6. FO (V) |
| 7. IN (V) | 8. GND (V) | 9. V_D (W) | 10. FO (W) | 11. IN (W) | 12. GND (W) |
| 13. V_D (L) | 14. FO (L) | 15. Open | 16. IN (B) | 17. IN (X) | 18. IN (Y) |
| 19. IN (Z) | 20. GND (L) | | | | |

Signal Terminal Layout

Unit: mm

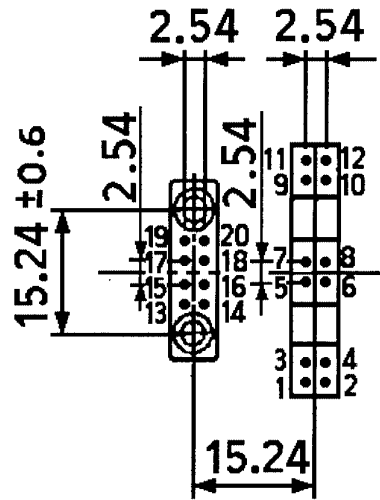

- | | | | | | |
|------------------------|-------------|-----------------------|------------|-----------------------|-------------|
| 1. V _D (U) | 2. FO (U) | 3. IN (U) | 4. GND (U) | 5. V _D (V) | 6. FO (V) |
| 7. IN (V) | 8. GND (V) | 9. V _D (W) | 10. FO (W) | 11. IN (W) | 12. GND (W) |
| 13. V _D (L) | 14. FO (L) | 15. Open | 16. IN (B) | 17. IN (X) | 18. IN (Y) |
| 19. IN (Z) | 20. GND (L) | | | | |

Maximum Ratings (T_j = 25°C)

Stage	Characteristic	Condition	Symbol	Rating	Unit
Inverter	Supply voltage	P-N Power terminal	V _{CC}	450	V
	Collector-emitter voltage	—	V _{CES}	600	V
	Collector current	T _c = 25°C, DC	I _C	75	A
	Forward current	T _c = 25°C, DC	I _F	75	A
	Collector power dissipation	T _c = 25°C, DC	P _C	460	W
	Junction temperature	—	T _j	150	°C
Brake	Supply voltage	P-N Power terminal	V _{CC}	450	V
	Collector-emitter voltage	—	V _{CES}	600	V
	Collector current	T _c = 25°C, DC	I _C	50	A
	Reverse voltage	—	V _R	600	V
	Forward current	T _c = 25°C, DC	I _F	50	A
	Collector power dissipation	T _c = 25°C	P _C	340	W
	Junction temperature	—	T _j	150	°C
Control	Control supply voltage	V _D -GND Terminal	V _D	20	V
	Input voltage	IN-GND Terminal	V _{IN}	20	V
	Fault output voltage	FO-GND Terminal	V _{FO}	20	V
	Fault output current	FO sink current	I _{FO}	14	mA
Module	Operating temperature	—	T _c	-20~ + 100	°C
	Storage temperature range	—	T _{stg}	-40~ + 125	°C
	Isolation voltage	AC 1 min	V _{ISO}	2500	V
	Screw torque (Terminal)	M4	—	2	N·m
	Screw torque (Mounting)	M5	—	3	

Electrical Characteristics

1. Inverter stage

Characteristics	Symbol	Test Condition	Min	Typ.	Max	Unit	
Collector cut-off current	I _{CEX}	V _{CE} = 600 V	T _j = 25°C	—	—	1	mA
			T _j = 125°C	—	—	10	
Collector-emitter saturation voltage	V _{CE (sat)}	V _D = 15 V I _C = 75 A V _{IN} = 15 V → 0 V	T _j = 25°C	1.5	1.8	2.2	V
			T _j = 125°C	—	2.0	—	
Forward voltage	V _F	I _F = 75 A, T _j = 25°C	—	1.8	2.2	V	
Switching time	t _{on}	V _{CC} = 300 V, I _C = 75 A V _D = 15 V, V _{IN} = 15 V ↔ 0 V T _j = 25°C, Inductive load (Note 1)	—	1.3	2.2	μs	
	t _{c (on)}		—	0.25	—		
	t _{rr}		—	0.2	—		
	t _{off}		—	1.1	2.1		
	t _{c (off)}		—	0.2	—		

Note 1: Switching time test circuit & timing chart

2. Brake stage

Characteristics	Symbol	Test Condition	Min	Typ.	Max	Unit	
Collector cut-off current	I_{CEX}	$V_{CE} = 600\text{ V}$	$T_j = 25^\circ\text{C}$	—	—	1	mA
			$T_j = 125^\circ\text{C}$	—	—	10	
Collector-emitter saturation voltage	$V_{CE(sat)}$	$V_D = 15\text{ V}$ $I_C = 50\text{ A}$ $V_{IN} = 15\text{ V} \rightarrow 0\text{ V}$	$T_j = 25^\circ\text{C}$	—	1.8	2.2	V
			$T_j = 125^\circ\text{C}$	—	2.0	—	
Reverse current	I_R	$V_R = 600\text{ V}$	$T_j = 25^\circ\text{C}$	—	—	1	mA
			$T_j = 125^\circ\text{C}$	—	—	10	
Forward voltage	V_F	$I_F = 50\text{ A}, T_j = 25^\circ\text{C}$	1.5	1.9	2.3	V	
Switching time	t_{on}	$V_{CC} = 300\text{ V}, I_C = 50\text{ A}$ $V_D = 15\text{ V}, V_{IN} = 15\text{ V} \leftrightarrow 0\text{ V}$ $T_j = 25^\circ\text{C}, \text{Inductive load}$ (Note 1)	—	1.3	1.8	μs	
	$t_c(\text{on})$		—	0.65	—		
	t_{rr}		—	0.8	—		
	t_{off}		—	1.1	2.1		
	$t_c(\text{off})$		—	0.2	—		

Note 1: Switching time test circuit & timing chart

3. Control stage ($T_j = 25^\circ\text{C}$)

Characteristics	Symbol	Test Condition	Min	Typ.	Max	Unit	
Control circuit current	High side	$I_D(H)$	$V_D = 15\text{ V}$	—	13	17	mA
	Low side			$I_D(L)$	—	52	
Input on signal voltage	$V_{IN(on)}$	$V_D = 15\text{ V}$	1.4	1.6	1.8	V	
Input off signal voltage	$V_{IN(off)}$		2.2	2.5	2.8		
Fault output current	Protection	$I_{FO(on)}$	$V_D = 15\text{ V}$	—	10	12	mA
	Normal			$I_{FO(off)}$	—	—	
Over current protection trip level	Inverter	OC	$V_D = 15\text{ V}, T_j \leq 125^\circ\text{C}$	120	—	—	A
	Brake			80	—	—	
Short circuit protection trip level	Inverter	SC	$V_D = 15\text{ V}, T_j \leq 125^\circ\text{C}$	120	—	—	A
	Brake			80	—	—	
Over current cut-off time	$t_{off(OC)}$	$V_D = 15\text{ V}$	—	5	—	μs	
Over temperature protection	Trip level	OT	Case temperature	110	118	125	$^\circ\text{C}$
	Reset level			OTr	—	98	
Control supply under voltage protection	Trip level	UV	—	11.0	12.0	12.5	V
	Reset level			UVr	12.0	12.5	
Fault output pulse width	t_{FO}	$V_D = 15\text{ V}$	1	2	3	ms	

4. Thermal resistance ($T_c = 25^\circ\text{C}$)

Characteristics	Symbol	Test Condition	Min	Typ.	Max	Unit
Junction to case thermal resistance	$R_{th(j-c)}$	Inverter IGBT	—	—	0.270	$^\circ\text{C/W}$
		Inverter FRD	—	—	0.313	
		Brake IGBT	—	—	0.360	
		Brake FRD	—	—	0.600	
Case to fin thermal resistance	$R_{th(c-f)}$	Compound is applied	—	0.017	—	$^\circ\text{C/W}$

Switching Time Test Circuit

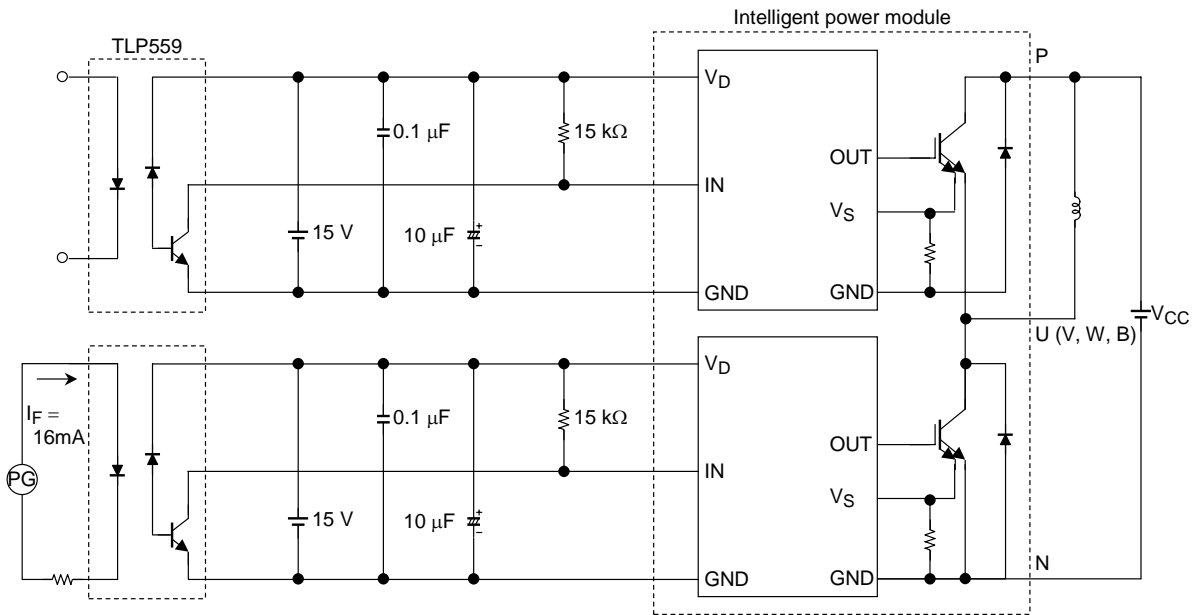

Timing Chart

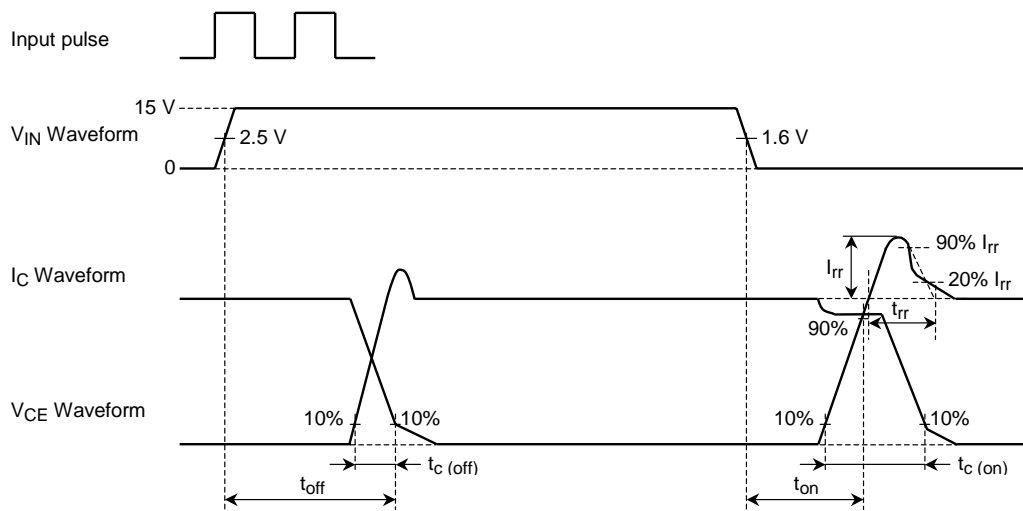

5. Recommended conditions for application

Characteristics	Symbol	Test Condition	Min	Typ.	Max	Unit
Supply voltage	V_{CC}	P-N Power terminal	—	300	400	V
Control supply voltage	V_D	V_D -GND Signal terminal	13.5	15	16.5	V
Carrier frequency	f_c	PWM Control	—	—	20	kHz
Dead time	t_{dead}	Switching time test circuit (See page.6) (Note 2)	3	—	—	μs

Note 2: The table lists Dead time requirements for the module input, excluding photocoupler delays. When specifying dead time requirements for the photocoupler input, please add photocoupler delays to the dead time given above.

Dead Time Timing Chart

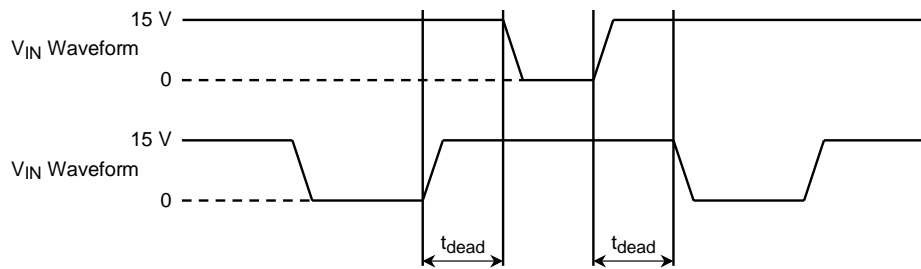

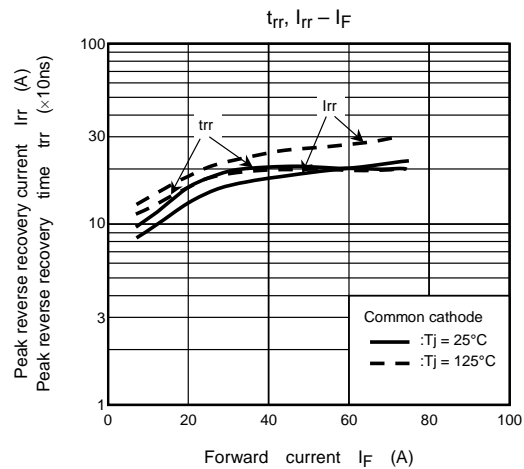
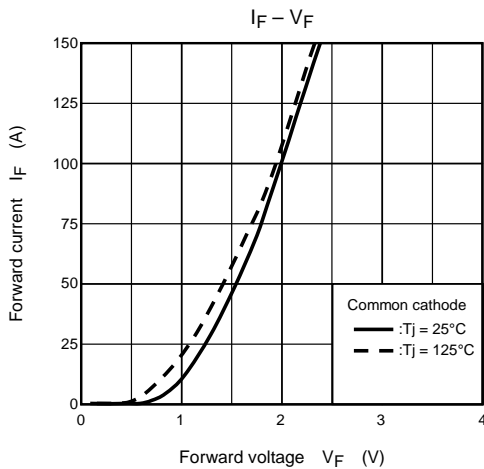
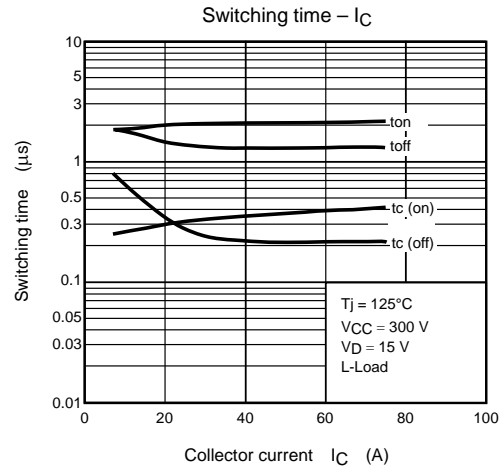
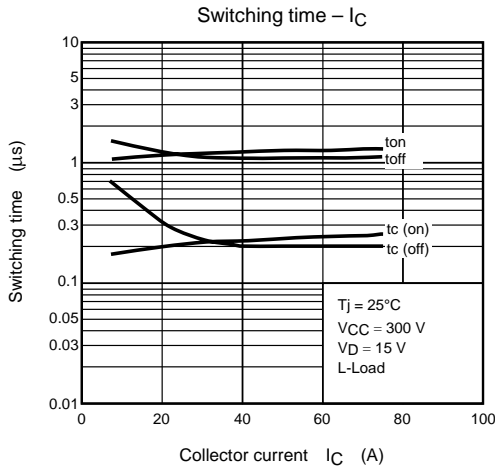
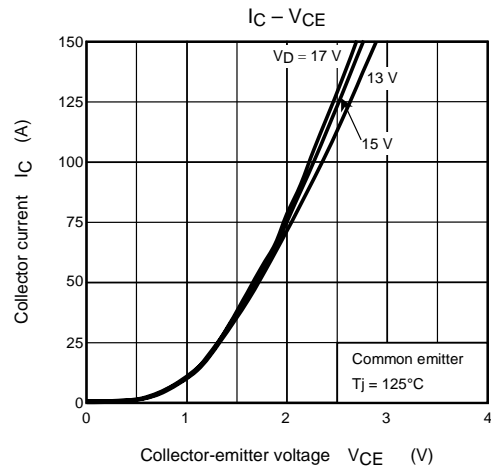
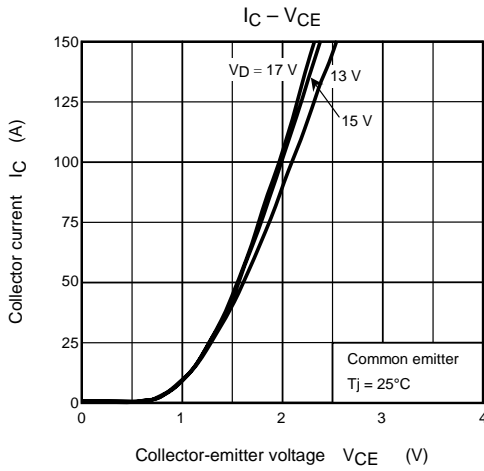

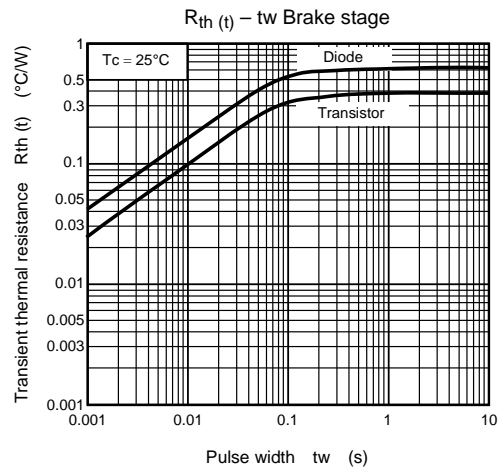
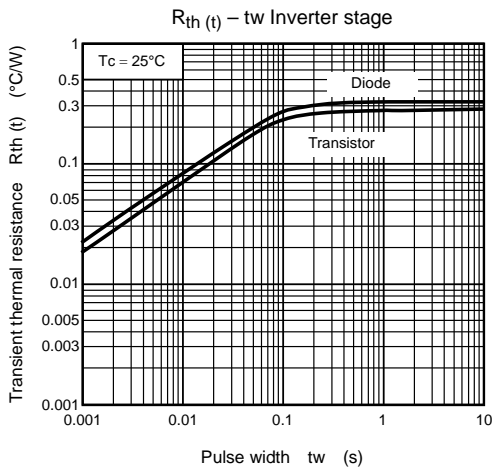
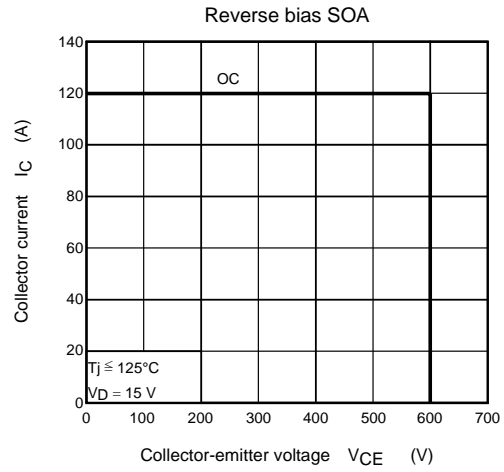
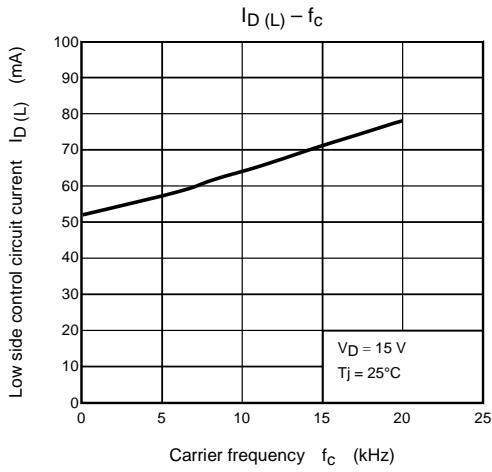
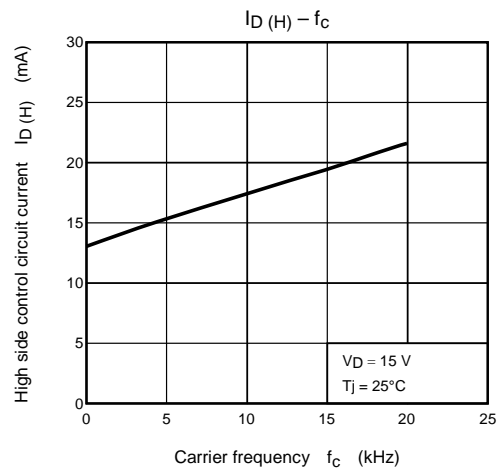
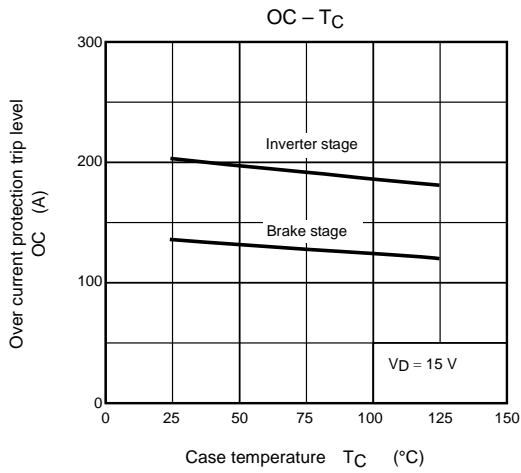

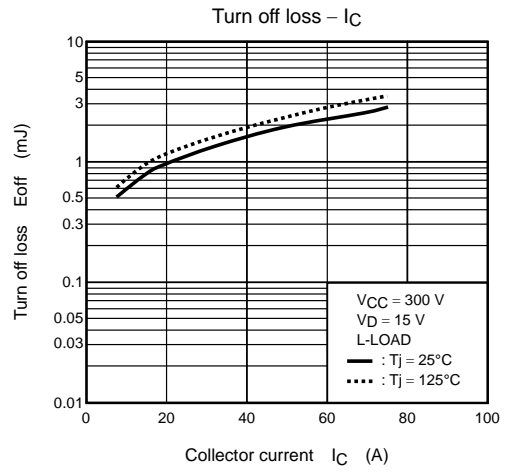
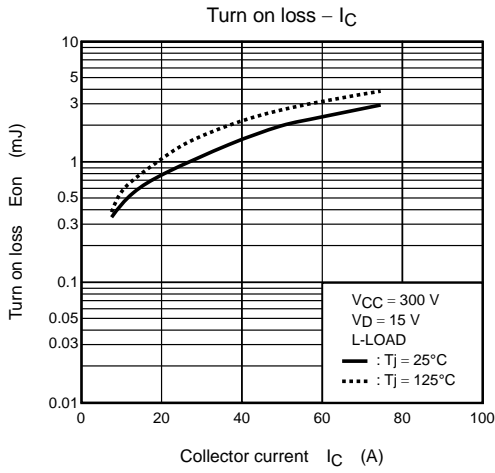

RESTRICTIONS ON PRODUCT USE

000707EAA

- TOSHIBA is continually working to improve the quality and reliability of its products. Nevertheless, semiconductor devices in general can malfunction or fail due to their inherent electrical sensitivity and vulnerability to physical stress. It is the responsibility of the buyer, when utilizing TOSHIBA products, to comply with the standards of safety in making a safe design for the entire system, and to avoid situations in which a malfunction or failure of such TOSHIBA products could cause loss of human life, bodily injury or damage to property.
In developing your designs, please ensure that TOSHIBA products are used within specified operating ranges as set forth in the most recent TOSHIBA products specifications. Also, please keep in mind the precautions and conditions set forth in the "Handling Guide for Semiconductor Devices," or "TOSHIBA Semiconductor Reliability Handbook" etc..
- The TOSHIBA products listed in this document are intended for usage in general electronics applications (computer, personal equipment, office equipment, measuring equipment, industrial robotics, domestic appliances, etc.). These TOSHIBA products are neither intended nor warranted for usage in equipment that requires extraordinarily high quality and/or reliability or a malfunction or failure of which may cause loss of human life or bodily injury ("Unintended Usage"). Unintended Usage include atomic energy control instruments, airplane or spaceship instruments, transportation instruments, traffic signal instruments, combustion control instruments, medical instruments, all types of safety devices, etc.. Unintended Usage of TOSHIBA products listed in this document shall be made at the customer's own risk.
- The information contained herein is presented only as a guide for the applications of our products. No responsibility is assumed by TOSHIBA CORPORATION for any infringements of intellectual property or other rights of the third parties which may result from its use. No license is granted by implication or otherwise under any intellectual property or other rights of TOSHIBA CORPORATION or others.
- The information contained herein is subject to change without notice.