

Technische Information / Technical Information

IGBT-Module
IGBT-Modules

FP15R12KE3G

eupec



Vorläufige Daten
Preliminary data

Elektrische Eigenschaften / Electrical properties

Höchstzulässige Werte / Maximum rated values

Diode Gleichrichter/ Diode Rectifier

| | | | | |
|---|---|--------------|------------|--|
| Periodische Rückw. Spitzensperrspannung repetitive peak reverse voltage | | V_{RRM} | 1600 | V |
| Gleichrichter Ausgang Grenzeffektivstrom maximum RMS current at Rectifier output | | I_{RMSmax} | 60 | A |
| Dauergleichstrom DC forward current | $T_C = 80^\circ\text{C}$ | I_d | 15 | A |
| Stoßstrom Grenzwert surge forward current | $t_p = 10\text{ ms}, T_{vj} = 25^\circ\text{C}$ $t_p = 10\text{ ms}, T_{vj} = 150^\circ\text{C}$ | I_{FSM} | 315 260 | A A |
| Grenzlastintegral I^2t - value | $t_p = 10\text{ ms}, T_{vj} = 25^\circ\text{C}$ $t_p = 10\text{ ms}, T_{vj} = 150^\circ\text{C}$ | I^2t | 500 340 | A^2s A^2s |

Transistor Wechselrichter/ Transistor Inverter

| | | | | |
|--|--|-----------------------|----------|--------|
| Kollektor-Emitter-Sperrspannung collector-emitter voltage | | V_{CES} | 1200 | V |
| Kollektor-Dauergleichstrom DC-collector current | $T_C = 80^\circ\text{C}$ $T_C = 25^\circ\text{C}$ | $I_{C,nom.}$ I_C | 15 25 | A A |
| Periodischer Kollektor Spitzenstrom repetitive peak collector current | $t_p = 1\text{ ms}, T_C = 80^\circ\text{C}$ | I_{CRM} | 30 | A |
| Gesamt-Verlustleistung total power dissipation | $T_C = 25^\circ\text{C}$ | P_{tot} | 100 | W |
| Gate-Emitter-Spitzenspannung gate-emitter peak voltage | | V_{GES} | +/- 20V | V |

Diode Wechselrichter/ Diode Inverter

| | | | | |
|--|--|-----------|----|----------------------|
| Dauergleichstrom DC forward current | $T_C = 80^\circ\text{C}$ | I_F | 15 | A |
| Periodischer Spitzenstrom repetitive peak forw. current | $t_p = 1\text{ ms}$ | I_{FRM} | 30 | A |
| Grenzlastintegral I^2t - value | $V_R = 0\text{V}, t_p = 10\text{ms}, T_{vj} = 125^\circ\text{C}$ | I^2t | 60 | A^2s |

Transistor Brems-Chopper/ Transistor Brake-Chopper

| | | | | |
|--|--|-----------------------|----------|--------|
| Kollektor-Emitter-Sperrspannung collector-emitter voltage | | V_{CES} | 1200 | V |
| Kollektor-Dauergleichstrom DC-collector current | $T_C = 80^\circ\text{C}$ $T_C = 25^\circ\text{C}$ | $I_{C,nom.}$ I_C | 10 18 | A A |
| Periodischer Kollektor Spitzenstrom repetitive peak collector current | $t_p = 1\text{ ms}, T_C = 80^\circ\text{C}$ | I_{CRM} | 20 | A |
| Gesamt-Verlustleistung total power dissipation | $T_C = 25^\circ\text{C}$ | P_{tot} | 80 | W |
| Gate-Emitter-Spitzenspannung gate-emitter peak voltage | | V_{GES} | +/- 20V | V |

Diode Brems-Chopper/ Diode Brake-Chopper

| | | | | |
|--|--------------------------|-----------|----|---|
| Dauergleichstrom DC forward current | $T_C = 80^\circ\text{C}$ | I_F | 10 | A |
| Periodischer Spitzenstrom repetitive peak forw. current | $t_p = 1\text{ ms}$ | I_{FRM} | 20 | A |

| | |
|-----------------------------|--------------------------------|
| prepared by: Andreas Schulz | date of publication:10.08.2001 |
| approved by: Robert Severin | revision: 1 |

Technische Information / Technical Information

IGBT-Module
IGBT-Modules

FP15R12KE3G

eupec



Vorläufige Daten Preliminary data

Modul Isolation/ Module Isolation

| | | | | |
|--|--|-------------------|-----|----|
| Isolations-Prüfspannung insulation test voltage | RMS, f = 50 Hz, t = 1 min. NTC connected to Baseplate | V _{ISOL} | 2,5 | kV |
|--|--|-------------------|-----|----|

Elektrische Eigenschaften / Electrical properties

Charakteristische Werte / Characteristic values

Diode Gleichrichter/ Diode Rectifier

| | | | min. | typ. | max. | |
|--|--|----------------------|------|------|------|----|
| Durchlaßspannung forward voltage | T _{vj} = 150°C, I _F = 15 A | V _F | - | 0,95 | - | V |
| Schleusenspannung threshold voltage | T _{vj} = 150°C | V _(TO) | - | - | 0,8 | V |
| Ersatzwiderstand slope resistance | T _{vj} = 150°C | r _T | - | - | 10,5 | mΩ |
| Sperrstrom reverse current | T _{vj} = 150°C, V _R = 1600 V | I _R | - | 2 | - | mA |
| Modul Leitungswiderstand, Anschlüsse-Chip lead resistance, terminals-chip | T _C = 25°C | R _{AA'+CC'} | - | 5 | - | mΩ |

Transistor Wechselrichter/ Transistor Inverter

| | | | min. | typ. | max. | |
|--|--|---------------------|------|------|------|-----|
| Kollektor-Emitter Sättigungsspannung collector-emitter saturation voltage | V _{GE} = 15V, T _{vj} = 25°C, I _C = 15 A | V _{CE sat} | - | 1,7 | 2,2 | V |
| | V _{GE} = 15V, T _{vj} = 125°C, I _C = 15 A | | - | 2 | - | V |
| Gate-Schwellenspannung gate threshold voltage | V _{CE} = V _{GE} , T _{vj} = 25°C, I _C = 0,5 mA | V _{GE(TO)} | 5,0 | 5,8 | 6,5 | V |
| Eingangskapazität input capacitance | f = 1MHz, T _{vj} = 25°C V _{CE} = 25 V, V _{GE} = 0 V | C _{ies} | - | 1,1 | - | nF |
| Kollektor-Emitter Reststrom collector-emitter cut off current | V _{GE} = 0V, T _{vj} = 25°C, V _{CE} = 1200 V | I _{CES} | - | - | 5 | mA |
| Gate-Emitter Reststrom gate-emitter leakage current | V _{CE} = 0V, V _{GE} = 20V, T _{vj} = 25°C | I _{GES} | - | - | 400 | nA |
| Einschaltverzögerungszeit (ind. Last) turn on delay time (inductive load) | I _C = I _{Nenn} , V _{CC} = 600 V V _{GE} = ±15V, T _{vj} = 25°C, R _G = 75 Ohm | t _{d,on} | - | 85 | - | ns |
| | V _{GE} = ±15V, T _{vj} = 125°C, R _G = 75 Ohm | | - | 90 | - | ns |
| Anstiegszeit (induktive Last) rise time (inductive load) | I _C = I _{Nenn} , V _{CC} = 600 V V _{GE} = ±15V, T _{vj} = 25°C, R _G = 75 Ohm | t _r | - | 30 | - | ns |
| | V _{GE} = ±15V, T _{vj} = 125°C, R _G = 75 Ohm | | - | 45 | - | ns |
| Abschaltverzögerungszeit (ind. Last) turn off delay time (inductive load) | I _C = I _{Nenn} , V _{CC} = 600 V V _{GE} = ±15V, T _{vj} = 25°C, R _G = 75 Ohm | t _{d,off} | - | 420 | - | ns |
| | V _{GE} = ±15V, T _{vj} = 125°C, R _G = 75 Ohm | | - | 520 | - | ns |
| Fallzeit (induktive Last) fall time (inductive load) | I _C = I _{Nenn} , V _{CC} = 600 V V _{GE} = ±15V, T _{vj} = 25°C, R _G = 75 Ohm | t _f | - | 65 | - | ns |
| | V _{GE} = ±15V, T _{vj} = 125°C, R _G = 75 Ohm | | - | 90 | - | ns |
| Einschaltverlustenergie pro Puls turn-on energy loss per pulse | I _C = I _{Nenn} , V _{CC} = 600 V V _{GE} = ±15V, T _{vj} = 125°C, R _G = 75 Ohm L _S = 45 nH | E _{on} | - | 2,1 | - | mWs |
| Abschaltverlustenergie pro Puls turn-off energy loss per pulse | I _C = I _{Nenn} , V _{CC} = 600 V V _{GE} = ±15V, T _{vj} = 125°C, R _G = 75 Ohm L _S = 45 nH | E _{off} | - | 1,5 | - | mWs |
| Kurzschlußverhalten SC Data | t _P ≤ 10µs, V _{GE} ≤ 15V, R _G = 75 Ohm T _{vj} ≤ 125°C, V _{CC} = 720 V | I _{SC} | - | 60 | - | A |

Technische Information / Technical Information

IGBT-Module
IGBT-Modules

FP15R12KE3G

eupec

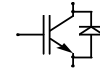

Vorläufige Daten
Preliminary data

Elektrische Eigenschaften / Electrical properties

Charakteristische Werte / Characteristic values

| | | min. | typ. | max. | | |
|--|---|-----------------|-------------|-------------|-------------|------------|
| Modulinduktivität stray inductance module | | $L_{\sigma CE}$ | - | - | 100 | nH |
| Modul Leitungswiderstand, Anschlüsse-Chip lead resistance, terminals-chip | $T_C = 25^\circ C$ | R_{CC+EE} | - | 7 | - | m Ω |
| Diode Wechselrichter/ Diode Inverter | | | min. | typ. | max. | |
| Durchlaßspannung forward voltage | $V_{GE} = 0V, T_{vj} = 25^\circ C, I_F = 15 A$ $V_{GE} = 0V, T_{vj} = 125^\circ C, I_F = 15 A$ | V_F | - | 1,65 | 2,2 | V |
| Rückstromspitze peak reverse recovery current | $I_F = I_{Nenn}, -di_F/dt = 400 A/\mu s$ $V_{GE} = -10V, T_{vj} = 25^\circ C, V_R = 600 V$ $V_{GE} = -10V, T_{vj} = 125^\circ C, V_R = 600 V$ | I_{RM} | - | 16 | - | A |
| Sperrverzögerungsladung recovered charge | $I_F = I_{Nenn}, -di_F/dt = 400 A/\mu s$ $V_{GE} = -10V, T_{vj} = 25^\circ C, V_R = 600 V$ $V_{GE} = -10V, T_{vj} = 125^\circ C, V_R = 600 V$ | Q_r | - | 1,8 | - | μAs |
| Abschaltenergie pro Puls reverse recovery energy | $I_F = I_{Nenn}, -di_F/dt = 400 A/\mu s$ $V_{GE} = -10V, T_{vj} = 25^\circ C, V_R = 600 V$ $V_{GE} = -10V, T_{vj} = 125^\circ C, V_R = 600 V$ | E_{RQ} | - | 0,55 | - | mWs |
| Transistor Brems-Chopper/ Transistor Brake-Chopper | | | min. | typ. | max. | |
| Kollektor-Emitter Sättigungsspannung collector-emitter saturation voltage | $V_{GE} = 15V, T_{vj} = 25^\circ C, I_C = 10 A$ $V_{GE} = 15V, T_{vj} = 125^\circ C, I_C = 10 A$ | $V_{CE sat}$ | - | 1,85 | 2,5 | V |
| Gate-Schwellenspannung gate threshold voltage | $V_{CE} = V_{GE}, T_{vj} = 25^\circ C, I_C = 0,3 mA$ | $V_{GE(TO)}$ | 5,0 | 5,8 | 6,5 | V |
| Eingangskapazität input capacitance | $f = 1MHz, T_{vj} = 25^\circ C$ $V_{CE} = 25 V, V_{GE} = 0 V$ | C_{ies} | - | 0,6 | - | nF |
| Kollektor-Emitter Reststrom collector-emitter cut off current | $V_{GE} = 0V, T_{vj} = 25^\circ C, V_{CE} = 1200 V$ | I_{CES} | - | 5,0 | - | mA |
| Gate-Emitter Reststrom gate-emitter leakage current | $V_{CE} = 0V, V_{GE} = 20V, T_{vj} = 25^\circ C$ | I_{GES} | - | - | 400 | nA |
| Schaltverluste und -bedingungen Switching losses and conditions | siehe Wechselrichter in Dbl FP10R12KE3 see inverter in datasheet FP10R12KE3 | | | | | |
| Diode Brems-Chopper/ Diode Brake-Chopper | | | min. | typ. | max. | |
| Durchlaßspannung forward voltage | $T_{vj} = 25^\circ C, I_F = 10 A$ $T_{vj} = 125^\circ C, I_F = 10 A$ | V_F | - | 1,8 | 2,5 | V |
| Schaltverluste und -bedingungen Switching losses and conditions | siehe Wechselrichter in Dbl FB10R12KE3 see inverter in datasheet FB10R12KE3 | | | | | |
| NTC-Widerstand/ NTC-Thermistor | | | min. | typ. | max. | |
| Nennwiderstand rated resistance | $T_C = 25^\circ C$ | R_{25} | - | 5 | - | k Ω |
| Abweichung von R_{100} deviation of R_{100} | $T_C = 100^\circ C, R_{100} = 493 \Omega$ | $\Delta R/R$ | -5 | | 5 | % |
| Verlustleistung power dissipation | $T_C = 25^\circ C$ | P_{25} | | | 20 | mW |
| B-Wert B-value | $R_2 = R_1 \exp [B(1/T_2 - 1/T_1)]$ | $B_{25/50}$ | | 3375 | | K |

Technische Information / Technical Information

IGBT-Module
IGBT-Modules

FP15R12KE3G

eupec



Vorläufige Daten Preliminary data

Thermische Eigenschaften / Thermal properties

| | | | | min. | typ. | max. | |
|--|--------------------------------|------------|-----|------|------|------|--|
| Innerer Wärmewiderstand thermal resistance, junction to case | Gleichr. Diode/ Rectif. Diode | R_{thJC} | - | - | 1 | K/W | |
| | Trans. Wechr./ Trans. Inverter | | - | - | 1,2 | K/W | |
| | Diode Wechr./ Diode Inverter | | - | - | 1,5 | K/W | |
| | Trans. Bremse/ Trans. Brake | | - | - | 1,5 | K/W | |
| | Diode Bremse/ Diode Brake | | - | - | 2,3 | K/W | |
| Übergangs-Wärmewiderstand thermal resistance, case to heatsink | Gleichr. Diode/ Rectif. Diode | R_{thCK} | - | 0,08 | - | K/W | |
| | Trans. Wechr./ Trans. Inverter | | - | 0,04 | - | K/W | |
| | Diode Wechr./ Diode Inverter | | - | 0,08 | - | K/W | |
| Höchstzulässige Sperrschichttemperatur maximum junction temperature | | T_{vj} | - | - | 150 | °C | |
| Betriebstemperatur operation temperature | | T_{op} | -40 | - | 125 | °C | |
| Lagertemperatur storage temperature | | T_{stg} | -40 | - | 125 | °C | |

Mechanische Eigenschaften / Mechanical properties

| | | | | | |
|--|--|---|--|-----------------|----|
| Innere Isolation internal insulation | | | | Al_2O_3 | |
| CTI comperative tracking index | | | | 225 | |
| Anzugsdrehmoment f. mech. Befestigung mounting torque | | M | | 3 $\pm 10\%$ | Nm |
| Gewicht weight | | G | | 180 | g |

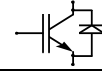

Vorläufige Daten
Preliminary data

Ausgangskennlinienfeld Wechselr. (typisch) $I_C = f(V_{CE})$
Output characteristic Inverter (typical) $V_{GE} = 15\text{ V}$

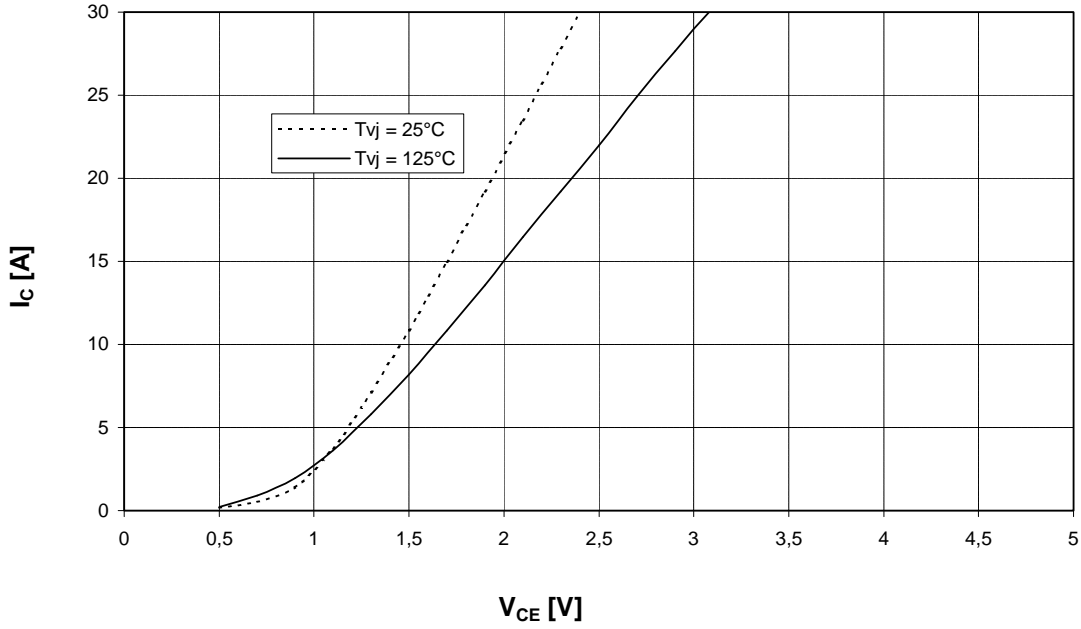

Ausgangskennlinienfeld Wechselr. (typisch) $I_C = f(V_{CE})$
Output characteristic Inverter (typical) $T_{vj} = 125^\circ\text{C}$

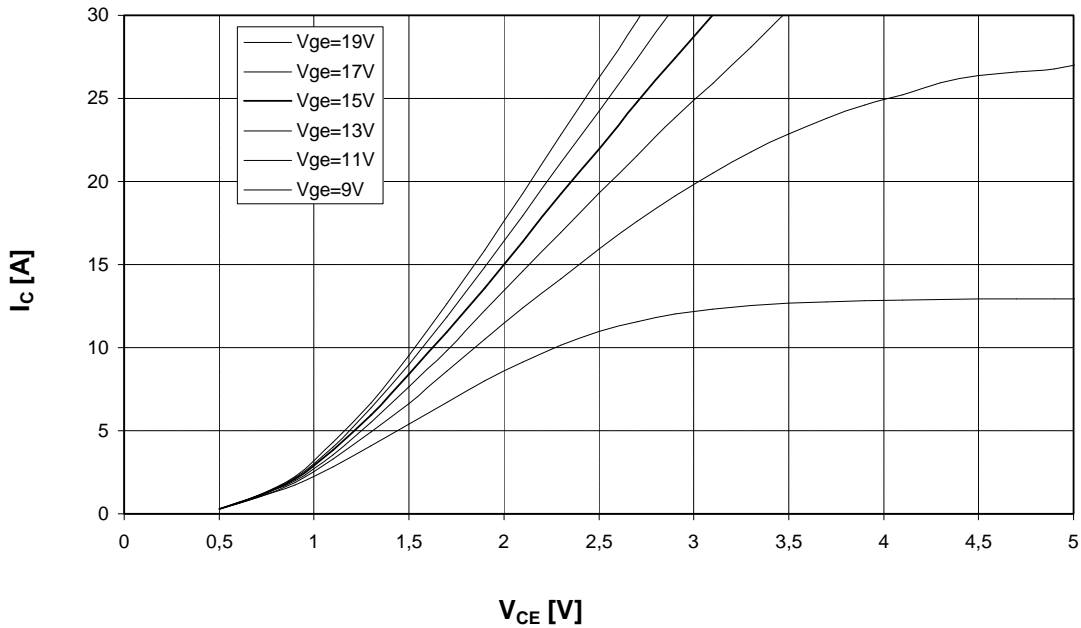

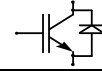

Vorläufige Daten
Preliminary data

Übertragungscharakteristik Wechselr. (typisch)
Transfer characteristic Inverter (typical)

$I_C = f(V_{GE})$
 $V_{CE} = 20\text{ V}$

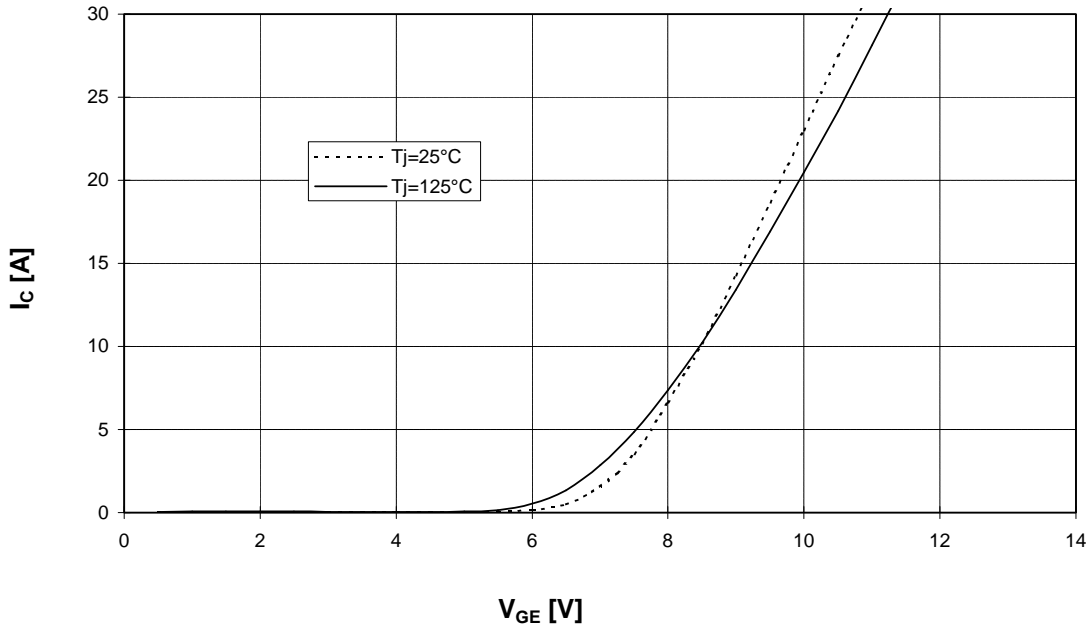

Durchlaßkennlinie der Freilaufdiode Wechselr. (typisch)
Forward characteristic of FWD Inverter (typical)

$I_F = f(V_F)$

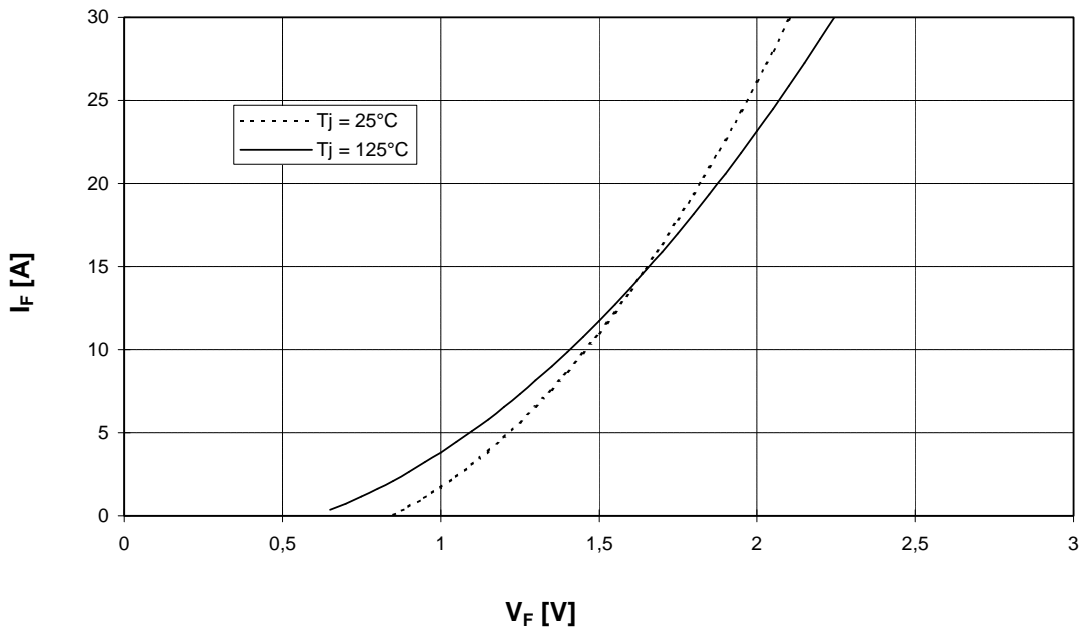

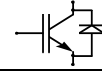

Vorläufige Daten

Preliminary data

Schaltverluste Wechselr. (typisch) $E_{on} = f(I_C), E_{off} = f(I_C), E_{rec} = f(I_C)$ $V_{CC} = 600\text{ V}$
 Switching losses Inverter (typical) $T_J = 125^\circ\text{C}, V_{GE} = \pm 15\text{ V}, R_{Gon} = R_{Goff} = 75\text{ Ohm}$

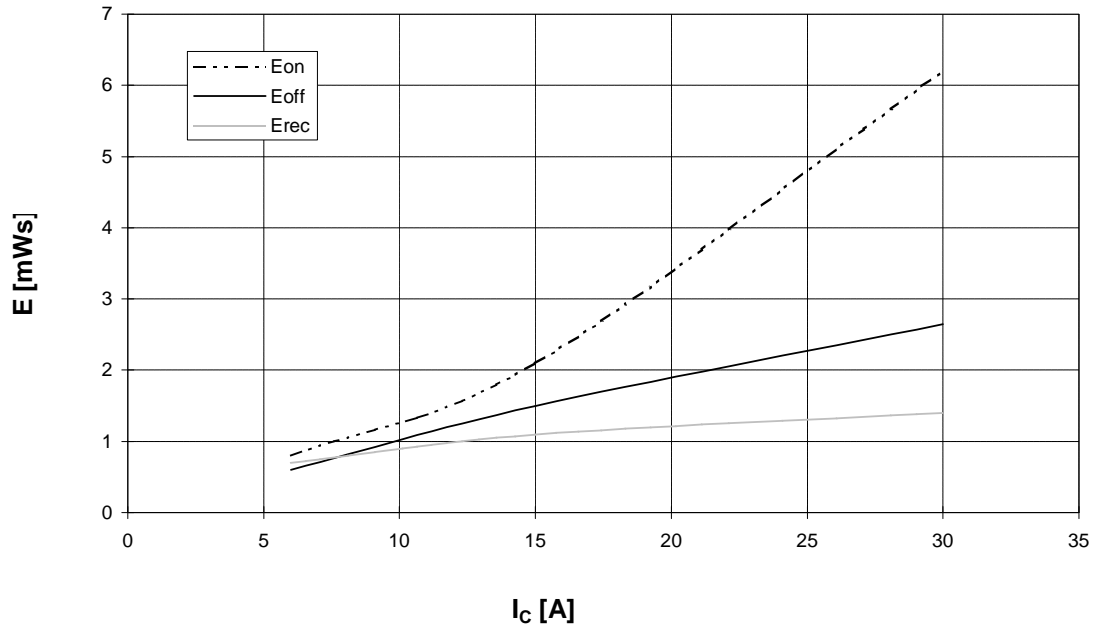

Schaltverluste Wechselr. (typisch) $E_{on} = f(R_G), E_{off} = f(R_G), E_{rec} = f(R_G)$
 Switching losses Inverter (typical) $T_J = 125^\circ\text{C}, V_{GE} = +15\text{ V}, I_C = I_{nenn}, V_{CC} = 600\text{ V}$

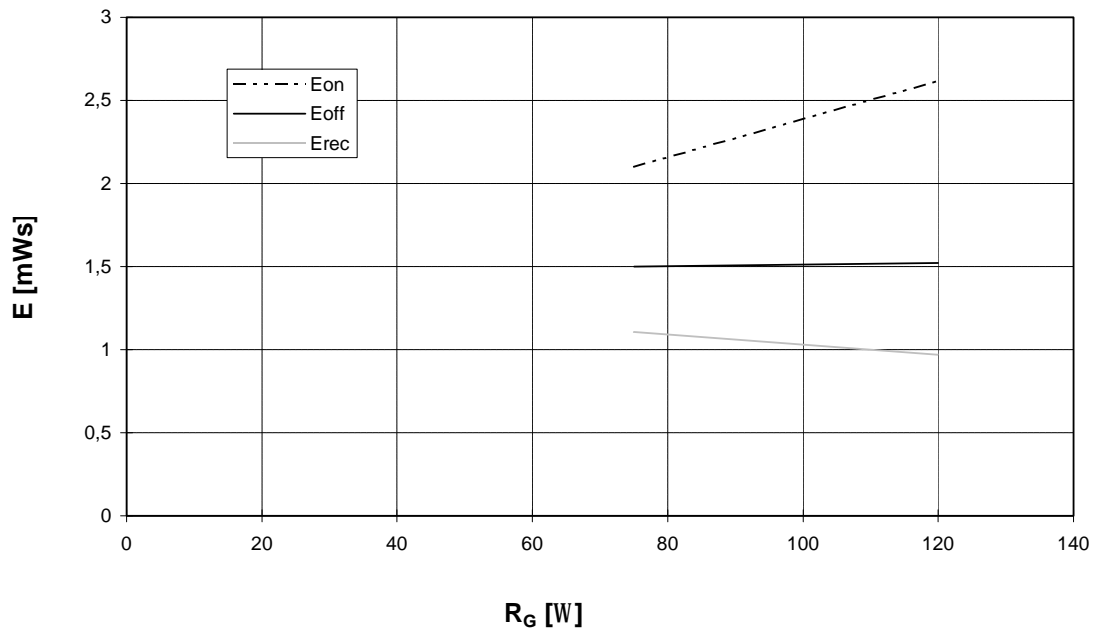

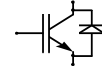

Vorläufige Daten
Preliminary data

Transienter Wärmewiderstand Wechselr. $Z_{thJC} = f(t)$
Transient thermal impedance Inverter

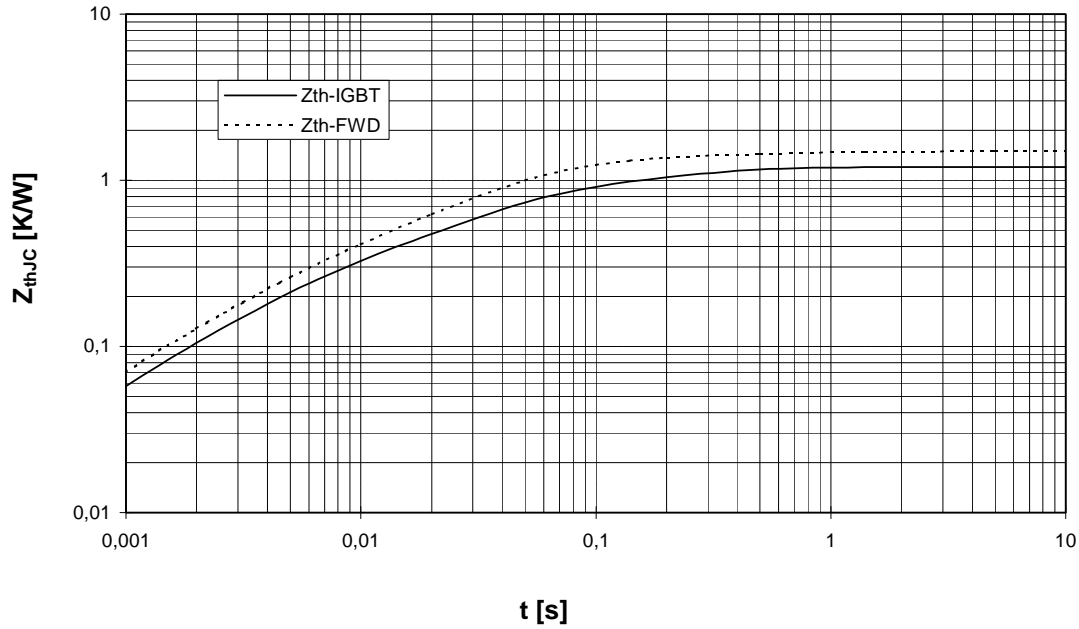

Sicherer Arbeitsbereich Wechselr. (RBSOA) $I_C = f(V_{CE})$
Reverse bias safe operating area Inverter (RBSOA) $T_{vi} = 125^\circ\text{C}, V_{GE} = \pm 15\text{V}$

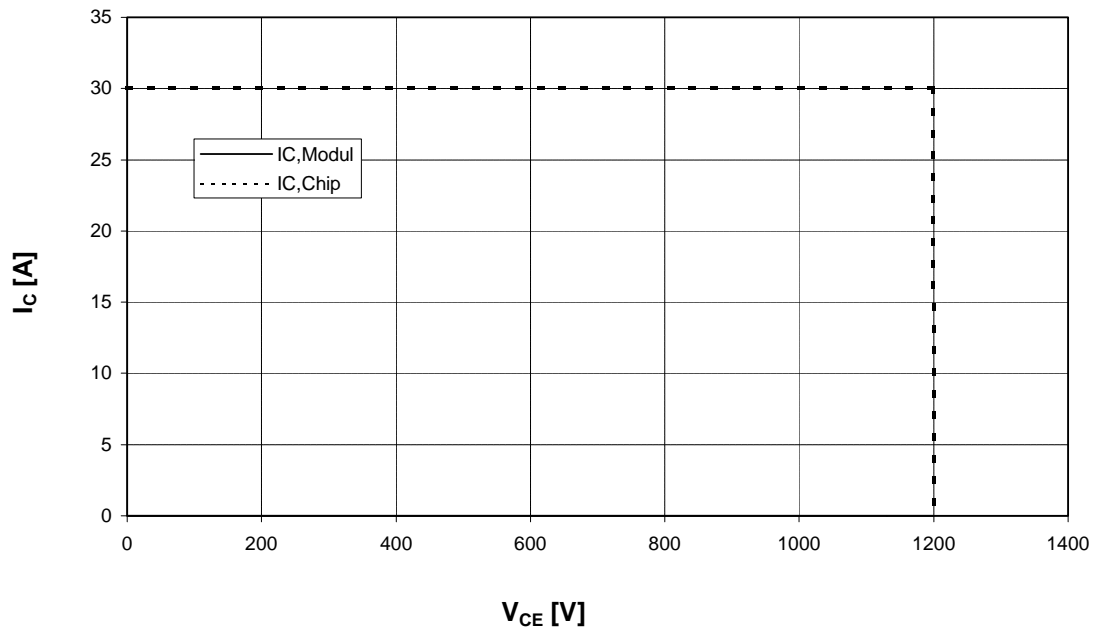

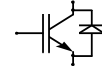

Vorläufige Daten

Preliminary data

Ausgangskennlinienfeld Brems-Chopper-IGBT (typisch)

Output characteristic brake-chopper-IGBT (typical)

$I_C = f(V_{CE})$

$V_{GE} = 15\text{ V}$

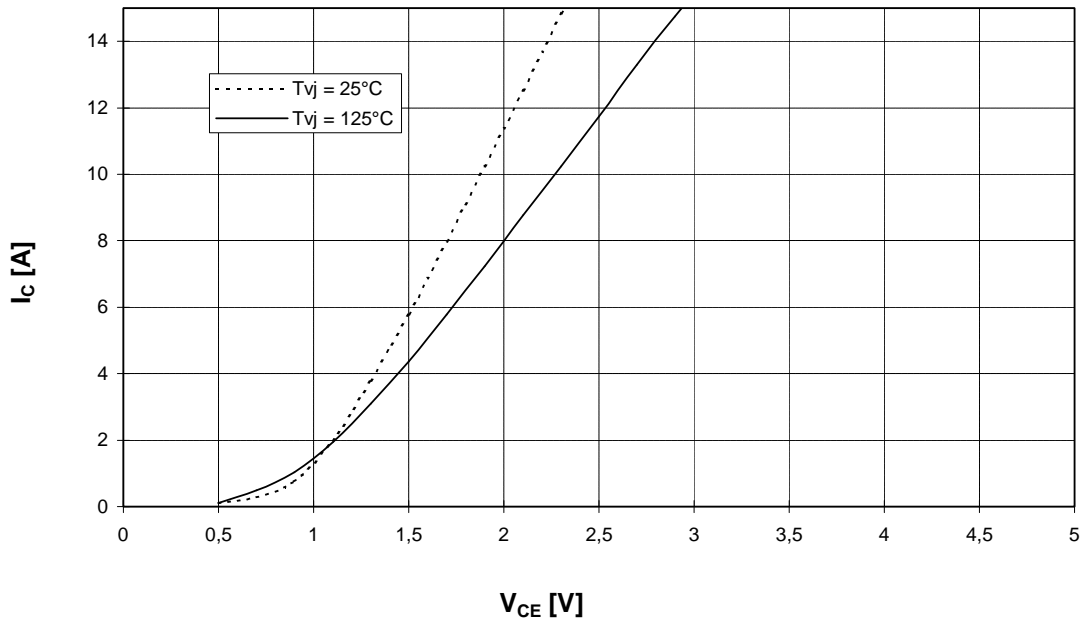

Durchlaßkennlinie der Brems-Chopper-Diode (typisch) $I_F = f(V_F)$

Forward characteristic of brake-chopper-FWD (typical)

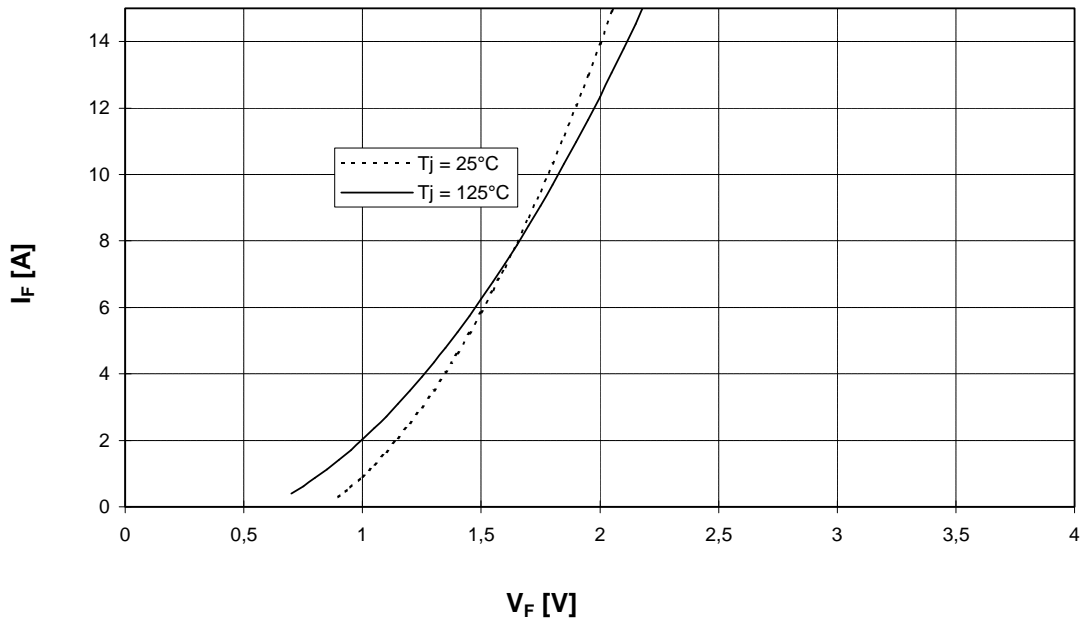

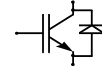

Vorläufige Daten
Preliminary data

Durchlaßkennlinie der Gleichrichterdiode (typisch) $I_F = f(V_F)$
Forward characteristic of Rectifier Diode (typical)

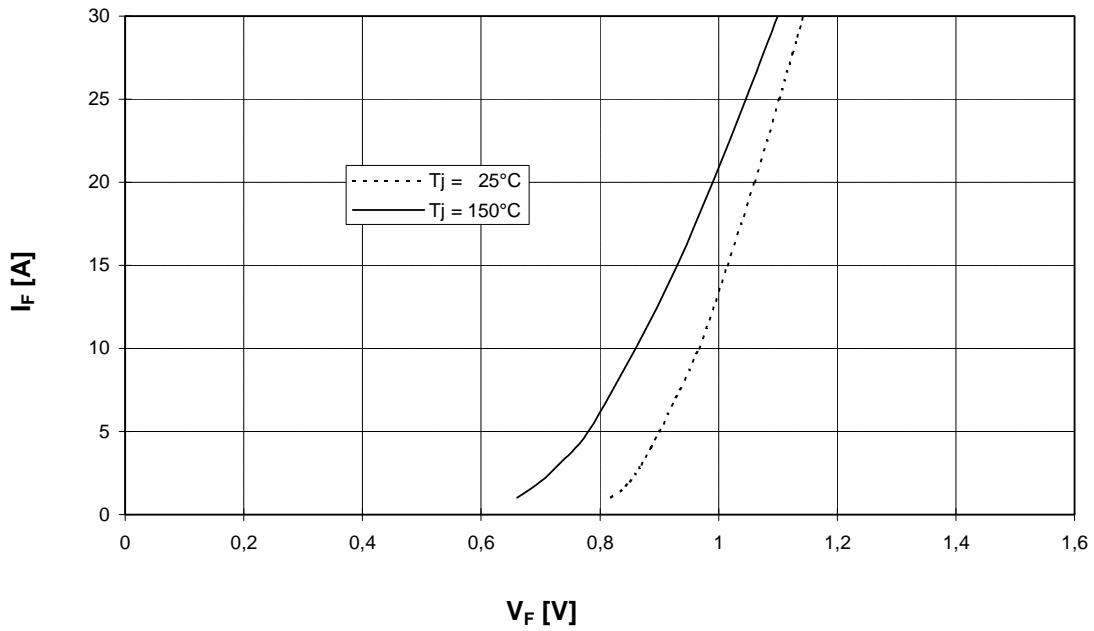

NTC- Temperaturkennlinie (typisch) $R = f(T)$
NTC- temperature characteristic (typical)

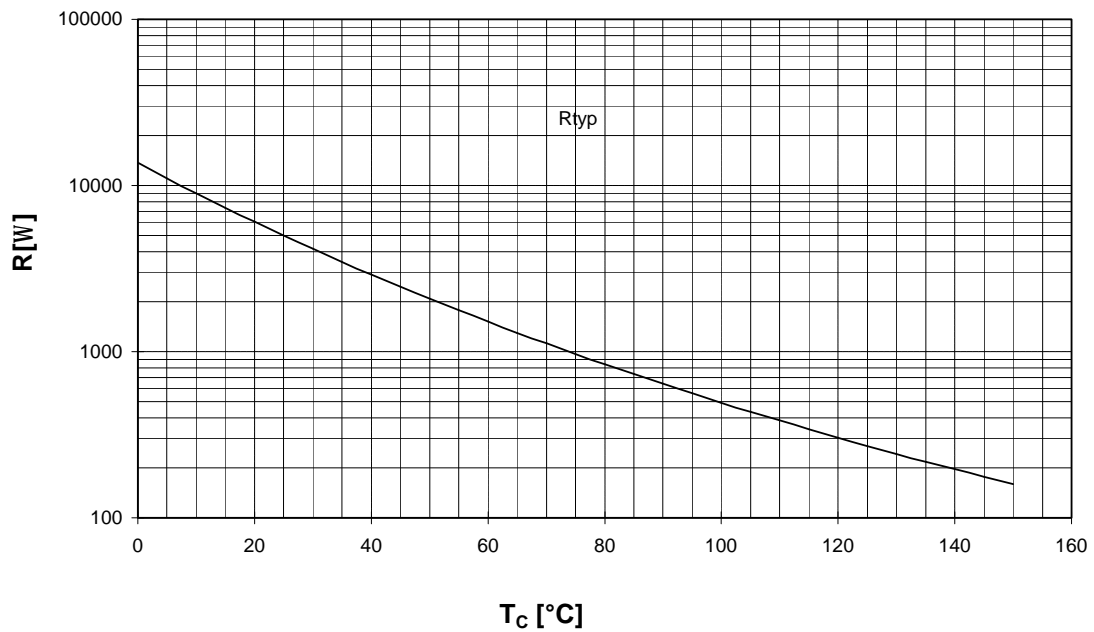

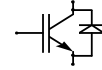

Vorläufige Daten
Preliminary data

Schaltplan/ Circuit diagram

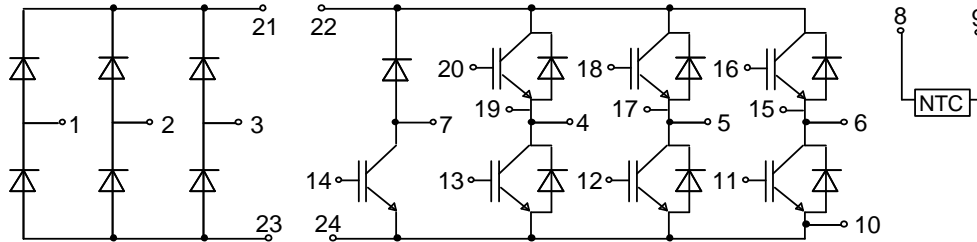

Gehäuseabmessungen/ Package outlines

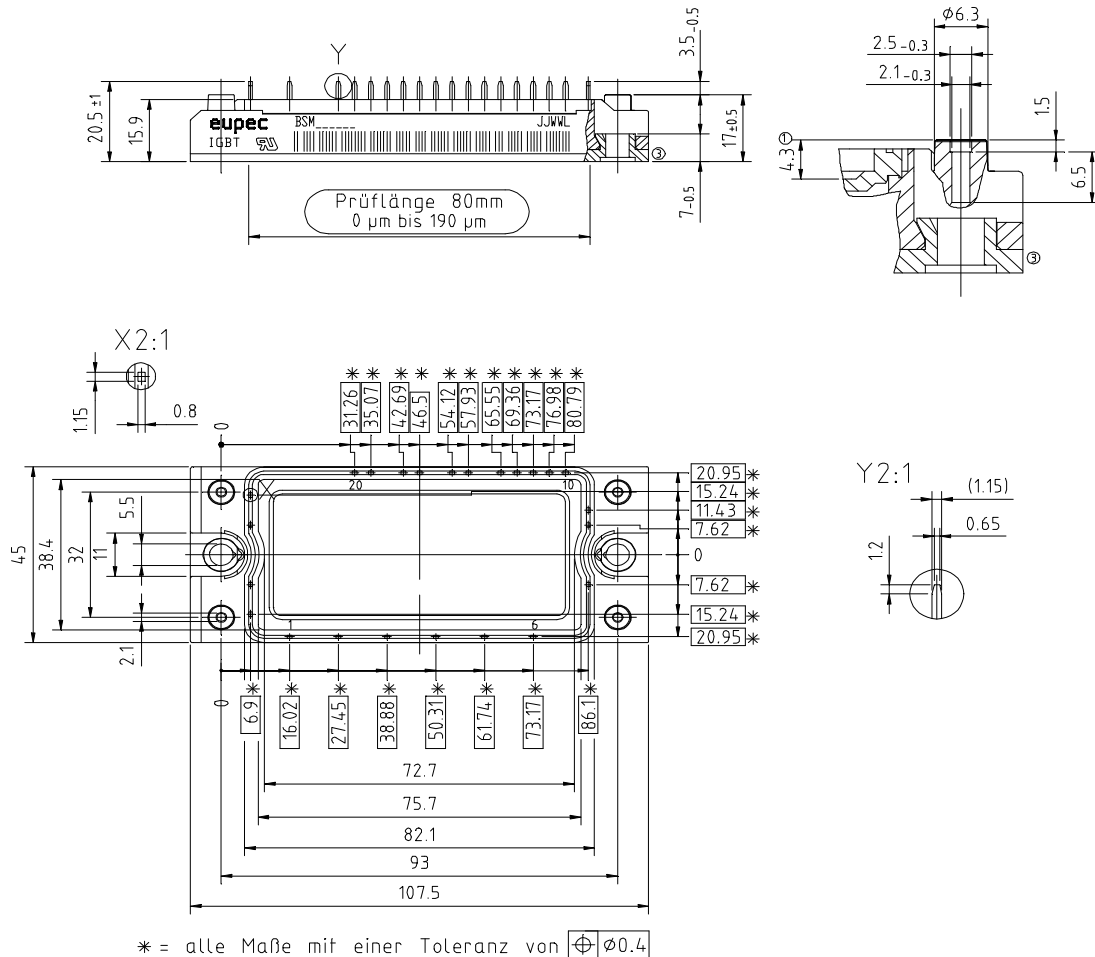

Mit dieser technischen Information werden Halbleiterbauelemente spezifiziert, jedoch keine Eigenschaften zugesichert. Sie gilt in Verbindung mit den zugehörigen Technischen Erläuterungen.

This technical information specifies semiconductor devices but promises no characteristics. It is valid in combination with the belonging technical notes.