

### IGBT MODULE (U series) 600V / 30A / PIM



#### ■ Features

- Low  $V_{CE(sat)}$
- Compact Package
- P.C. Board Mount Module
- Converter Diode Bridge Dynamic Brake Circuit

#### ■ Applications

- Inverter for Motoe Drive
- AC and DC Servo Drive Amplifier
- Uninterruptible Power Supply

#### ■ Maximum ratings and characteristics

● Absolute maximum ratings ( $T_c=25^\circ\text{C}$  unless ptherwise specified)

Item	Symbol	Condition	Rating	Unit	
Inverter	Collector-Emitter voltage	$V_{CES}$	600	V	
	Gate-Emitter voltage	$V_{GES}$	$\pm 20$	V	
	Collector current	$I_C$	Continuous	30	A
		$I_{CP}$	1ms	60	
		$-I_C$		30	
		$-I_C$ pulse	1ms	60	
Collector power dissipation	$P_C$	1 device	133	W	
Brake	Collector-Emitter voltage	$V_{CES}$	600	V	
	Gate-Emitter voltage	$V_{GES}$	$\pm 20$	V	
	Collector current	$I_C$	Continuous	20	A
		$I_{CP}$	1ms	40	A
	Collector power dissipation	$P_C$	1 device	104	W
	Repetitive peak reverse voltage	$V_{RRM}$		600	V
Converter	Repetitive peak reverse voltage	$V_{RRM}$	800	V	
	Average output current	$I_b$	50Hz/60Hz sine wave	30	A
	Surge current (Non-Repetitive)	$I_{FSM}$	$T_j=150^\circ\text{C}$ , 10ms	210	A
	$I^2t$ (Non-Repetitive)	$I^2t$	half sine wave	221	$\text{A}^2\text{s}$
Operating junction temperature	$T_j$		+150	$^\circ\text{C}$	
Storage temperature	$T_{stg}$		-40 to +125	$^\circ\text{C}$	
Isolation voltage	$V_{iso}$	AC : 1 minute	between terminal and copper base *2	AC 2500	V
			between thermistor and others *3	AC 2500	
Mounting screw torque			3.5 *1	N·m	

\*1 Recommendable value : 2.5 to 3.5 N·m (M5)

\*2 All terminals should be connected together when isolation test will be done.

\*3 Two thermistor terminals should be connected together, each other terminals should be connected together and shorted to base plate when isolation test will be done.

## ● Electrical characteristics (Tj=25°C unless otherwise specified)

Item	Symbol	Condition	Characteristics			Unit			
			Min.	Typ.	Max.				
Inverter	Zero gate voltage collector current	ICES	VCE=600V, VGE=0V			1.0	mA		
	Gate-Emitter leakage current	IGES	VCE=0V, VGE=±20V			200	nA		
	Gate-Emitter threshold voltage	VGE(th)	VCE=20V, Ic=30mA			6.2	6.7	7.7	V
	Collector-Emitter saturation voltage	VCE(sat) (terminal)	VGE=15V Ic=30A	Tj=25°C	2.10	2.40	V		
				Tj=125°C	2.40				
		VCE(sat) (chip)	Tj=25°C	1.85					
			Tj=125°C	2.15					
	Input capacitance	Cies	VGE=0V, VCE=10V, f=1MHz			1.7		nF	
	Turn-on time	ton	VCC=300V			0.36	1.20	µs	
		tr	Ic=30A			0.20	0.60		
		tr(i)	VGE=±15V			0.05			
	Turn-off time	toff	RG=120Ω			0.45	1.20	µs	
		tf				0.04	0.45		
	Forward on voltage	VF (terminal)	VGE=0V IF=30A	Tj=25°C	2.10	2.65	V		
Tj=125°C				2.00					
VF (chip)		Tj=25°C	1.85						
		Tj=125°C	1.75						
Reverse recovery time	trr	IF=30A				0.35	µs		
Brake	Zero gate voltage collector current	ICES	VCE=600V, VGE=0V			1.0	mA		
	Gate-Emitter leakage current	IGES	VCE=0V, VGE=±20V			200	nA		
	Collector-Emitter saturation voltage	VCE(sat) (terminal)	Ic=20A VGE=15V	Tj=25°C	1.85	2.15	V		
				Tj=125°C	2.15				
		VCE(sat) (chip)	Tj=25°C	1.70					
			Tj=125°C	2.00					
	Turn-on time	ton	VCC=300V			0.45	1.20	µs	
		tr	Ic=20A			0.15	0.60		
	Turn-off time	toff	VGE=±15V			0.37	1.20	µs	
		tf	RG=150Ω			0.04	0.45		
	Reverse current	IRRM	VR=600V				1.0	mA	
	Converter	Forward on voltage	IF=30A VGE=0V	terminal	1.20	1.50	V		
				chip	1.10				
	Reverse current	IRRM	VR=800V				1.0	mA	
Thermistor	Resistance	R	T=25°C	5000		Ω			
			T=100°C	465	495		520		
B value	B	T=25/50°C			3305	3375	3450	K	

## ● Thermal resistance Characteristics

Item	Symbol	Condition	Characteristics			Unit
			Min.	Typ.	Max.	
Thermal resistance ( 1 device )	Rth(j-c)	Inverter IGBT			0.94	°C/W
		Inverter FWD			1.60	
		Brake IGBT			1.20	
		Converter Diode			1.20	
Contact thermal resistance *	Rth(c-f)	With thermal compound		0.05		

\* This is the value which is defined mounting on the additional cooling fin with thermal compound

## ■ Equivalent Circuit Schematic

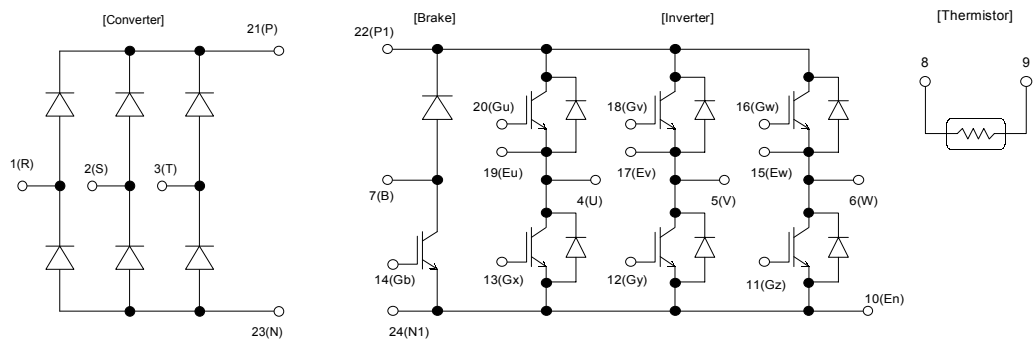

■ Characteristics (Representative)

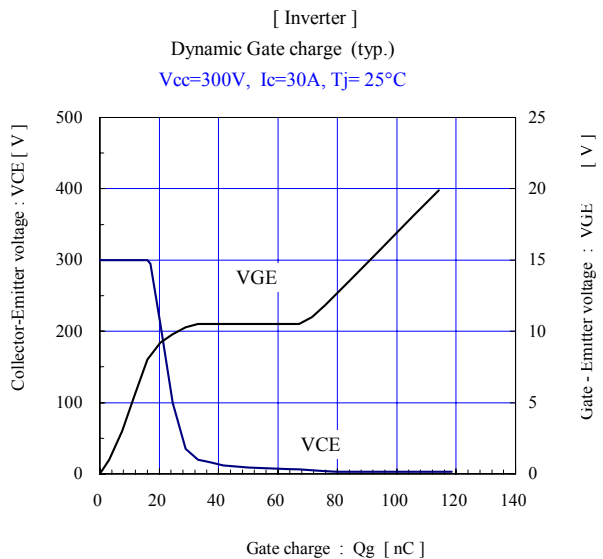
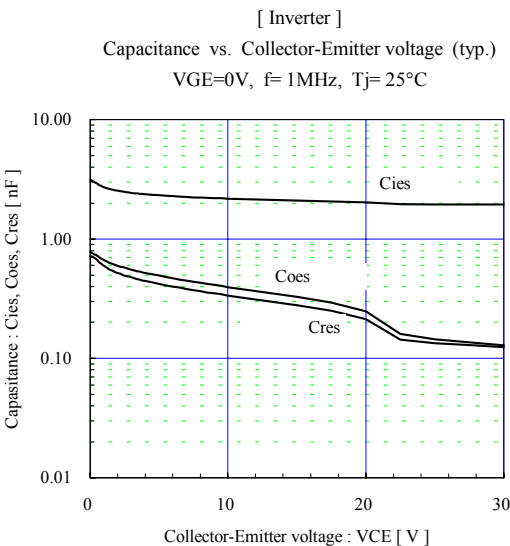
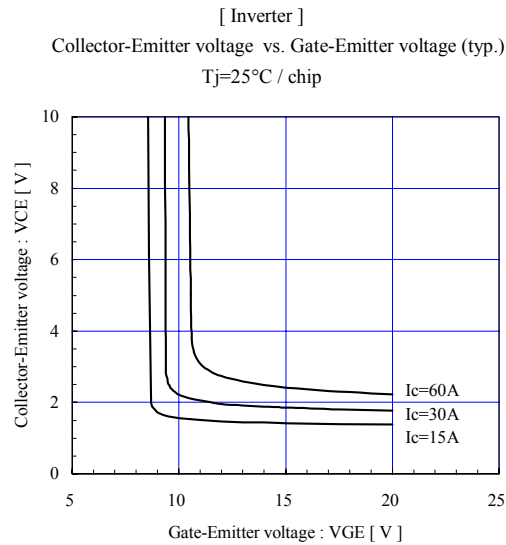
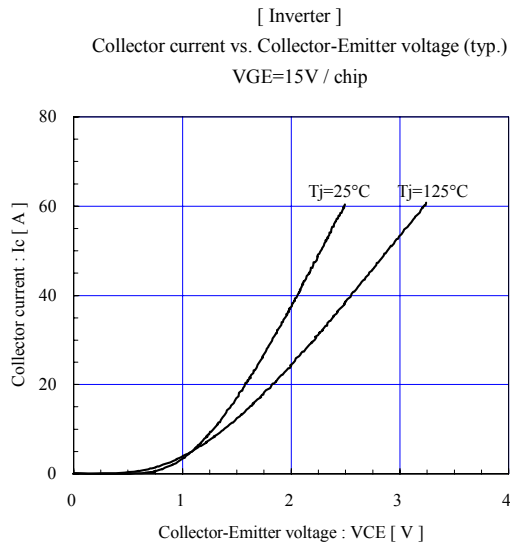
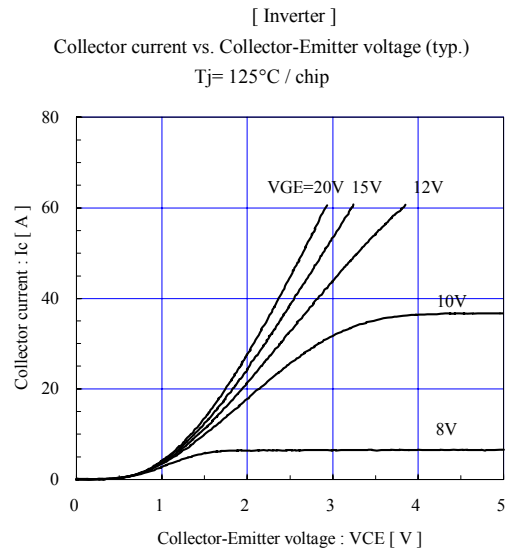
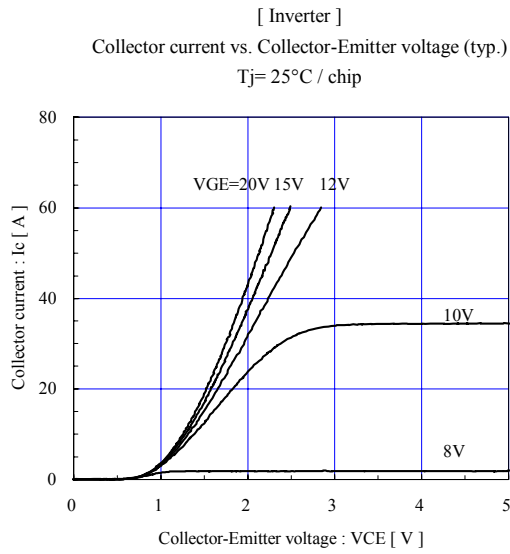

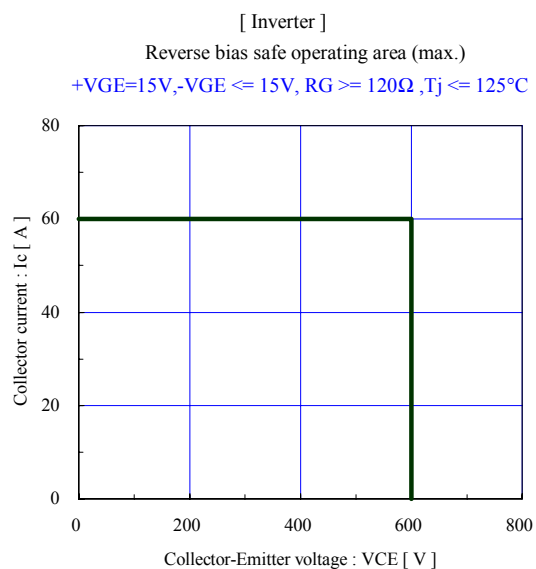
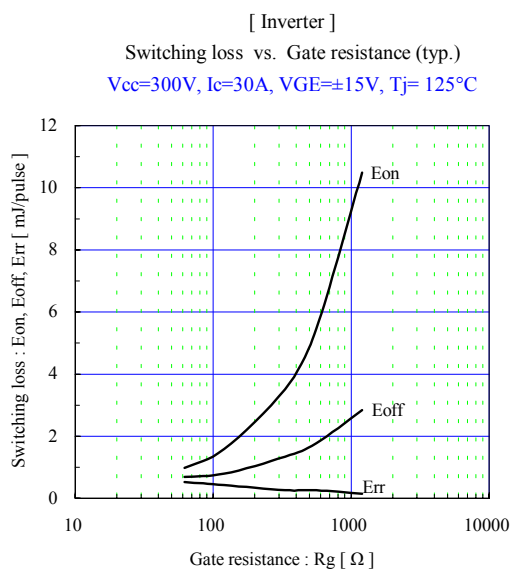
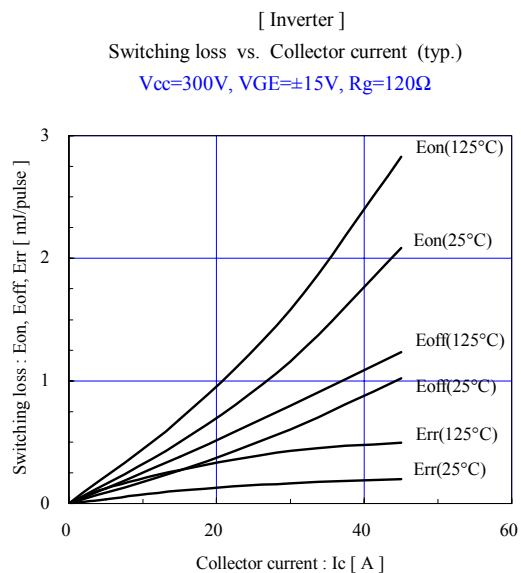
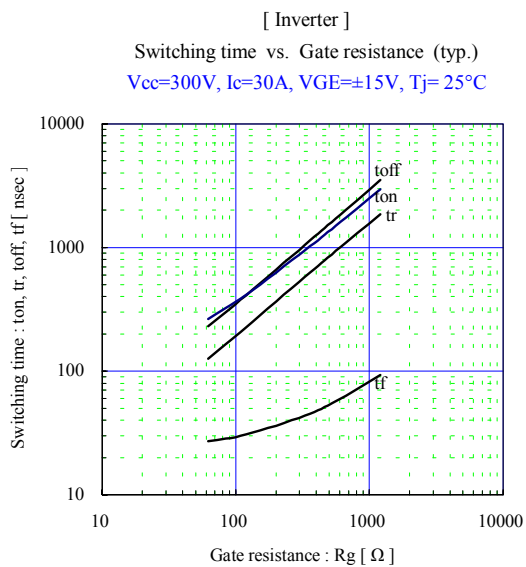
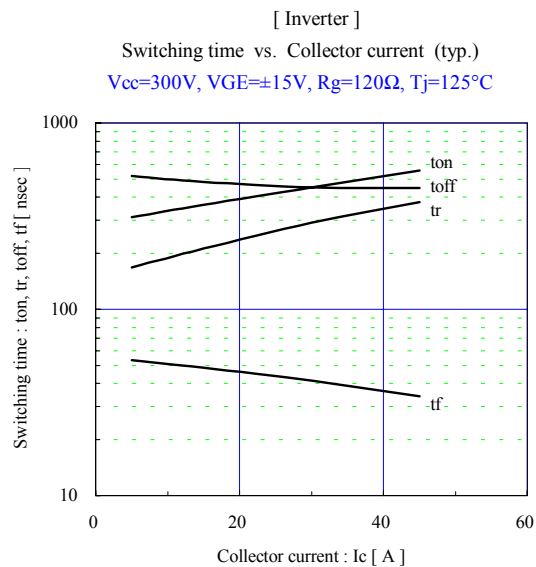
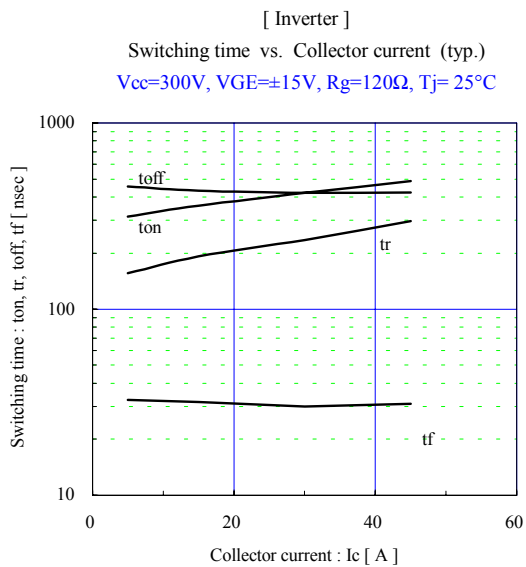

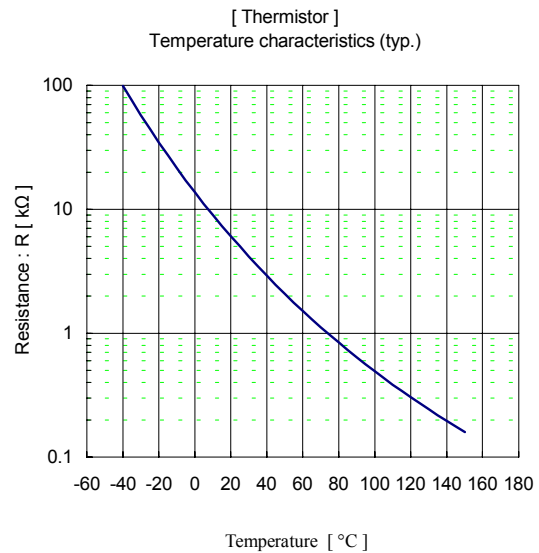
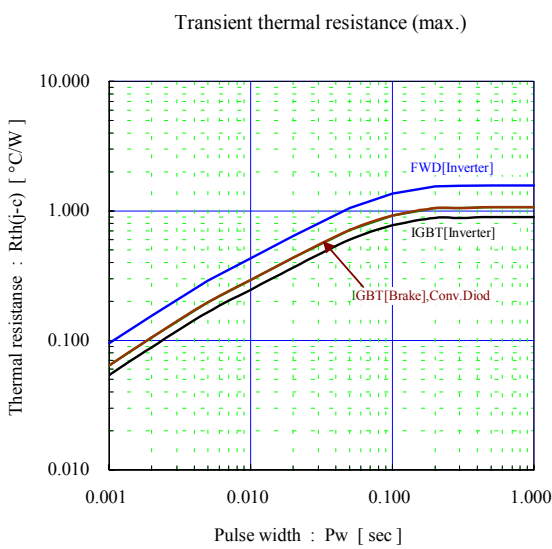
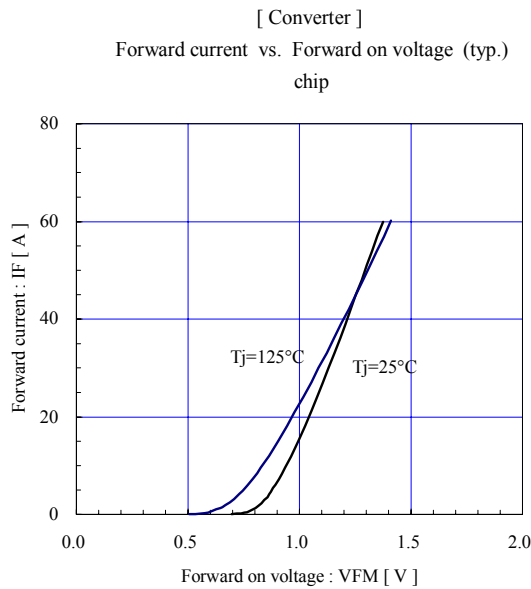
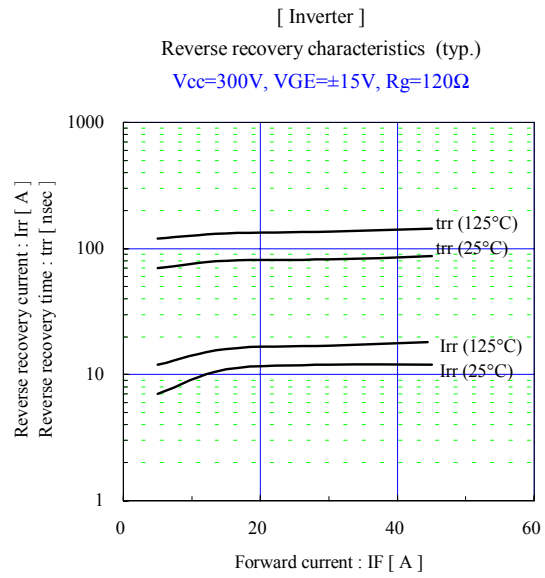
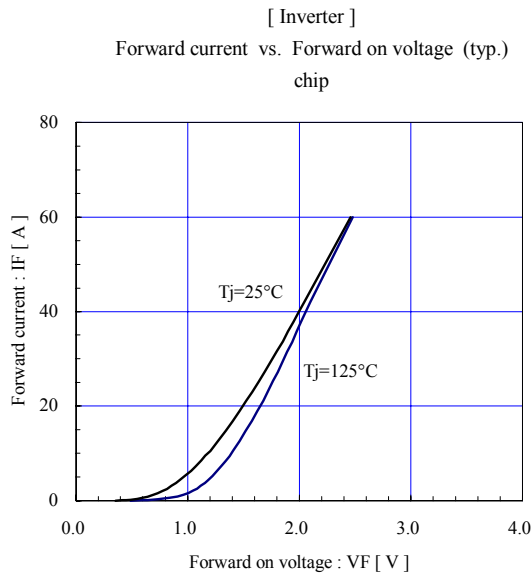

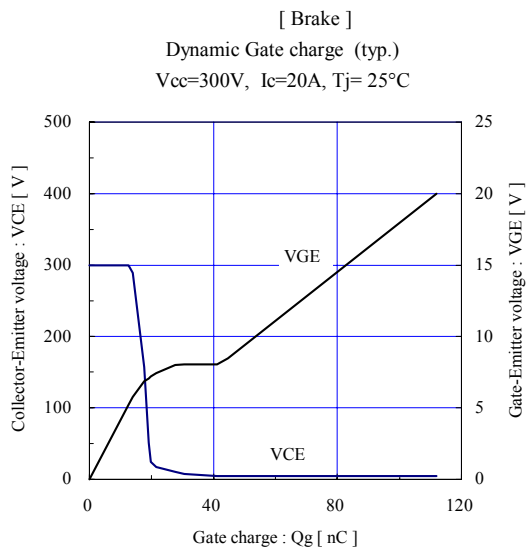
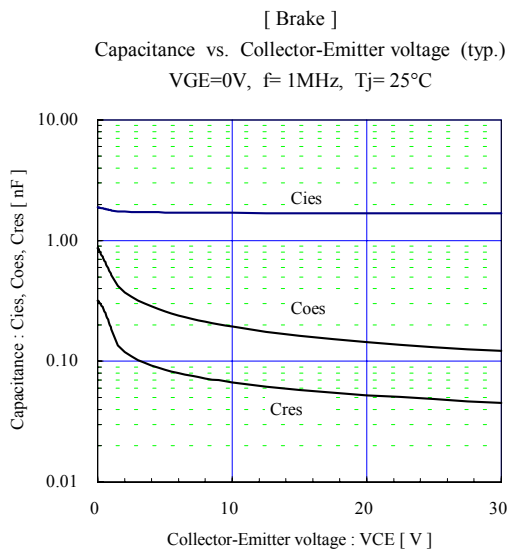
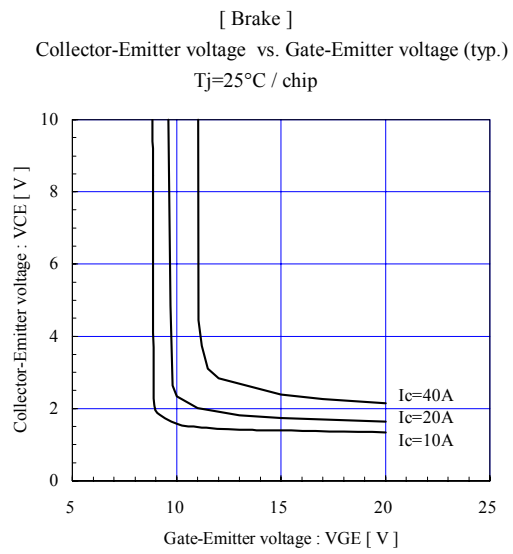
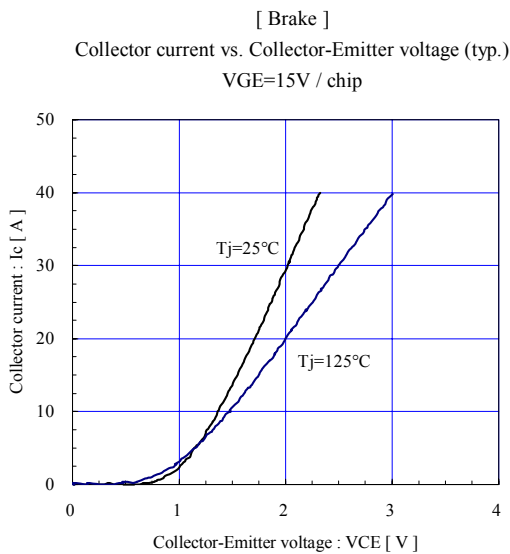
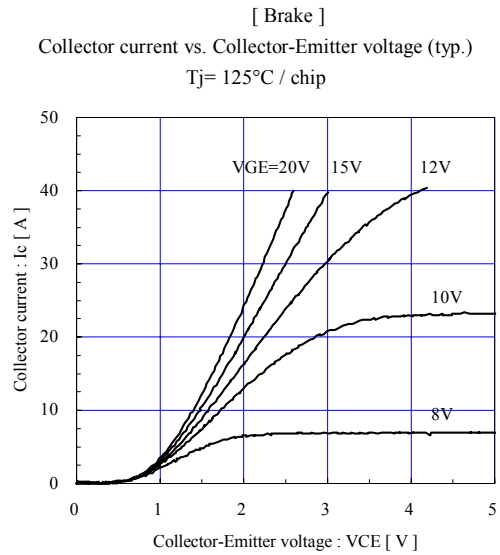
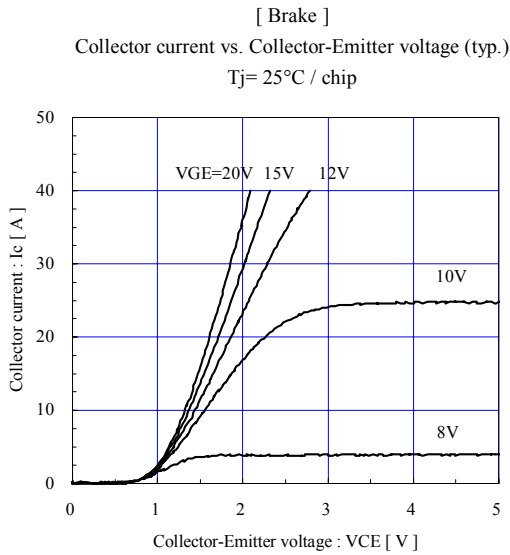

■ Outline Drawings, mm

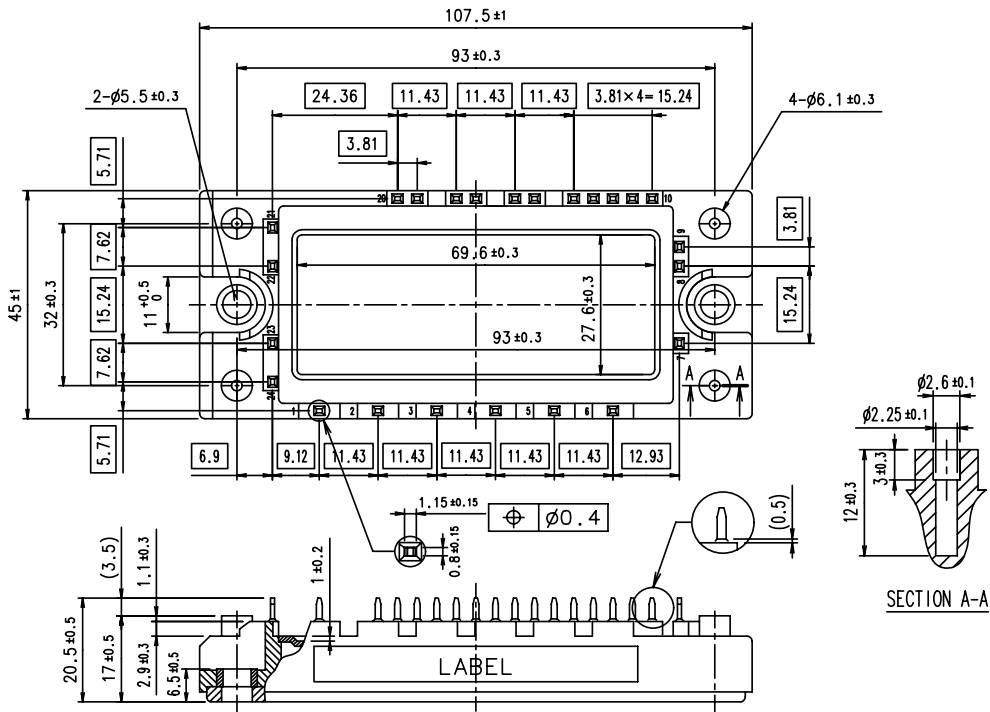

□ shows theoretical dimension.  
 ( ) shows reference dimension.