

MITSUBISHI IGBT MODULES
CM300DU-12F

HIGH POWER SWITCHING USE

CM300DU-12F



- IC 300A
- VCES 600V
- Insulated Type
- 2-elements in a pack

APPLICATION

General purpose inverters & Servo controls, etc

OUTLINE DRAWING & CIRCUIT DIAGRAM

Dimensions in mm

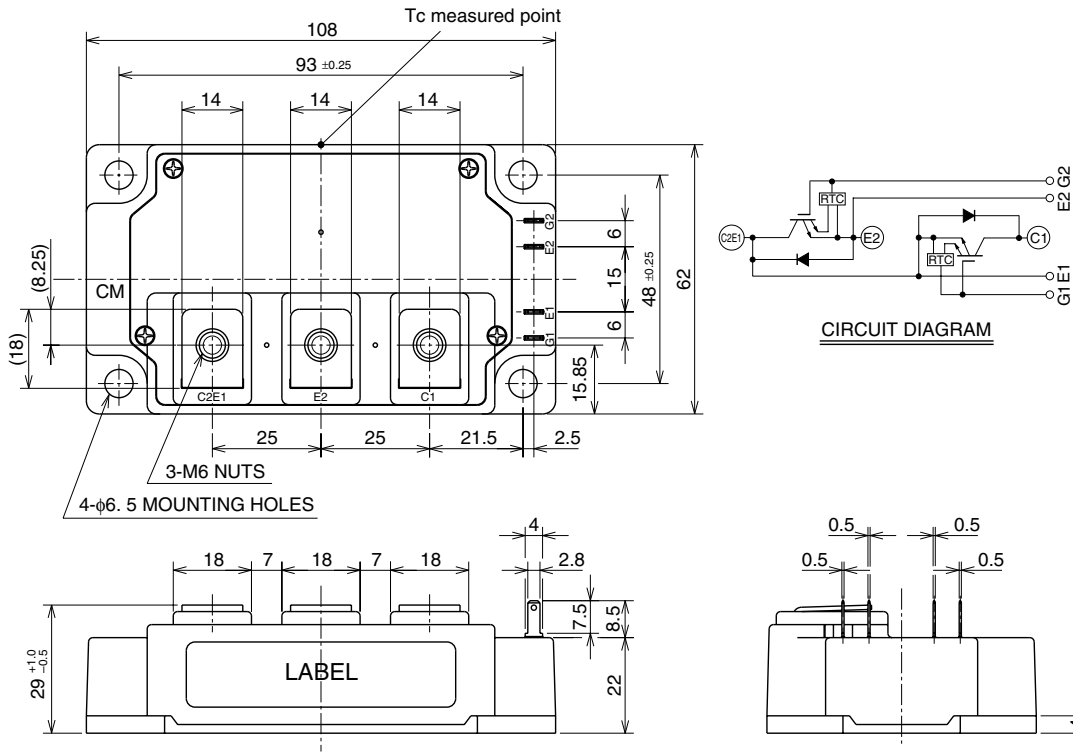

Feb. 2009



CM300DU-12F

HIGH POWER SWITCHING USE

MAXIMUM RATINGS (Tj = 25°C, unless otherwise specified)

Symbol	Parameter	Conditions	Ratings	Unit
VCES	Collector-emitter voltage	G-E Short	600	V
VGES	Gate-emitter voltage	C-E Short	±20	V
IC	Collector current	Tc = 25°C	300	A
ICM		Pulse (Note 2)	600	
IE (Note 1)	Emitter current	Tc = 25°C	300	A
IEM (Note 1)		Pulse (Note 2)	600	
PC (Note 3)	Maximum collector dissipation	Tc = 25°C	780	W
Tj	Junction temperature		-40 ~ +150	°C
Tstg	Storage temperature		-40 ~ +125	°C
Viso	Isolation voltage	Terminals to base plate, f = 60Hz, AC 1 minute	2500	Vrms
—	Torque strength	Main terminals M6 screw	3.5 ~ 4.5	N • m
—		Mounting M6 screw	3.5 ~ 4.5	N • m
—	Weight	Typical value	400	g

ELECTRICAL CHARACTERISTICS (Tj = 25°C, unless otherwise specified)

Symbol	Parameter	Test conditions	Limits			Unit
			Min.	Typ.	Max.	
ICES	Collector cutoff current	VCE = VCES, VGE = 0V	—	—	1	mA
VGE(th)	Gate-emitter threshold voltage	IC = 30mA, VCE = 10V	5	6	7	V
IGES	Gate leakage current	±VGE = VGES, VCE = 0V	—	—	40	µA
VCE(sat)	Collector-emitter saturation voltage	IC = 300A, VGE = 15V				V
		Tj = 25°C	—	1.6	2.2	
		Tj = 125°C	—	1.6	—	
Cies	Input capacitance	VCE = 10V VGE = 0V	—	—	81	nF
Coes	Output capacitance		—	—	5.4	
Cres	Reverse transfer capacitance		—	—	3.0	
QG	Total gate charge	VCC = 300V, IC = 300A, VGE = 15V	—	1860	—	nC
td(on)	Turn-on delay time	VCC = 300V, IC = 300A VGE = ±15V RG = 2.1Ω, Inductive load IE = 300A	—	—	250	ns
tr	Turn-on rise time		—	—	120	
td(off)	Turn-off delay time		—	—	500	
tf	Turn-off fall time		—	—	250	
trr (Note 1)	Reverse recovery time		—	—	150	
Qrr (Note 1)	Reverse recovery charge		—	5.2	—	
VEC(Note 1)	Emitter-collector voltage	IE = 300A, VGE = 0V	—	—	2.6	V
Rth(j-c)Q	Thermal resistance*1	IGBT part (1/2 module)	—	—	0.16	K/W
Rth(j-c)R		FWDi part (1/2 module)	—	—	0.24	
Rth(c-f)	Contact thermal resistance	Case to heat sink, Thermal compound applied*2 (1/2 module)	—	0.04	—	
Rth(j-c)Q	Thermal resistance	Case temperature measured point is just under the chips	—	—	0.10*3	
RG	External gate resistance		2.1	—	21	Ω

Note 1. IE, VEC, trr, Qrr & die/dt represent characteristics of the anti-parallel, emitter-collector free-wheel diode (FWDi).

2. Pulse width and repetition rate should be such that the device junction temperature (Tj) does not exceed Tjmax rating.

3. Junction temperature (Tj) should not increase beyond 150°C.

4. Pulse width and repetition rate should be such as to cause negligible temperature rise.

*1 : Case temperature (Tc) measured point is indicated in OUTLINE DRAWING.

*2 : Typical value is measured by using thermally conductive grease of λ = 0.9[W/(m • K)].

*3 : If you use this value, Rth(f-a) should be measured just under the chips.

PERFORMANCE CURVES

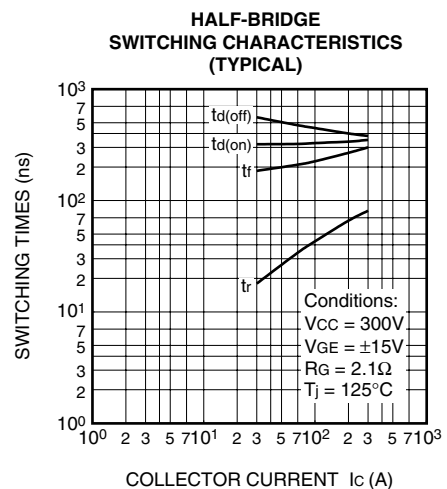
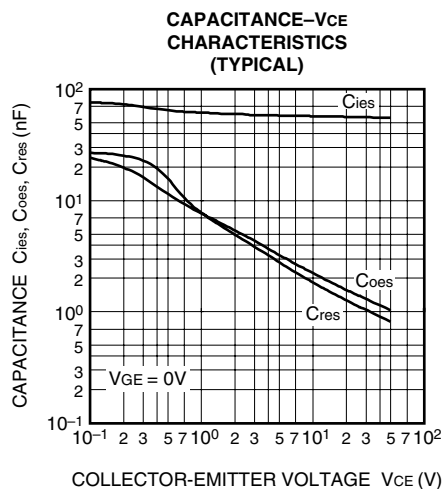
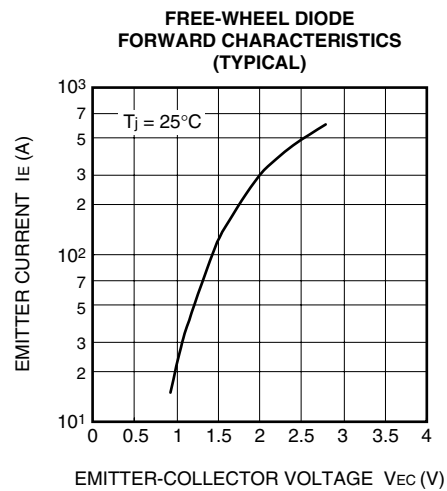
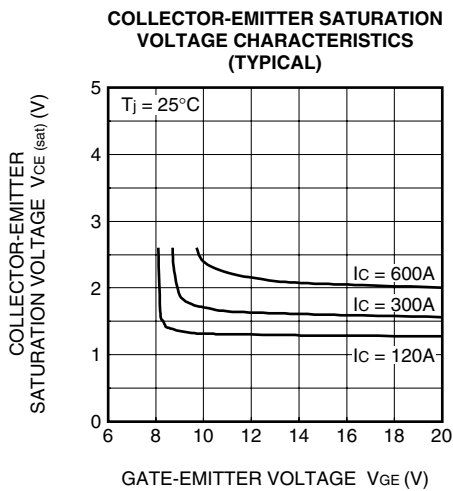
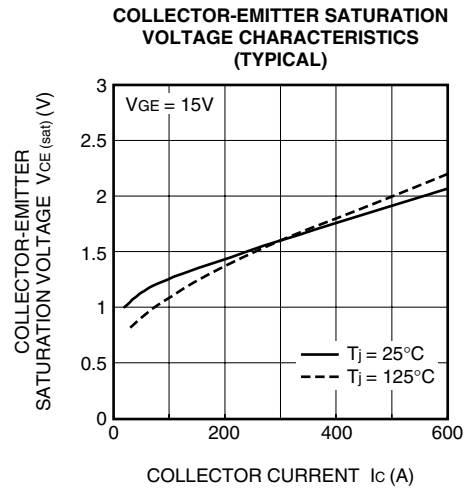
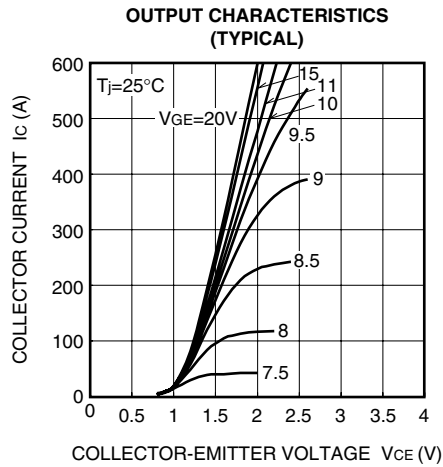

REVERSE RECOVERY CHARACTERISTICS OF FREE-WHEEL DIODE (TYPICAL)

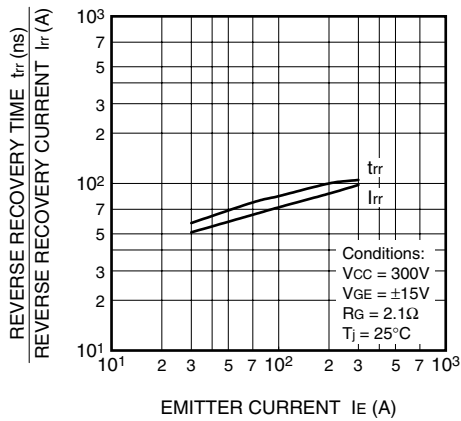

TRANSIENT THERMAL IMPEDANCE CHARACTERISTICS (IGBT part & FWDi part)

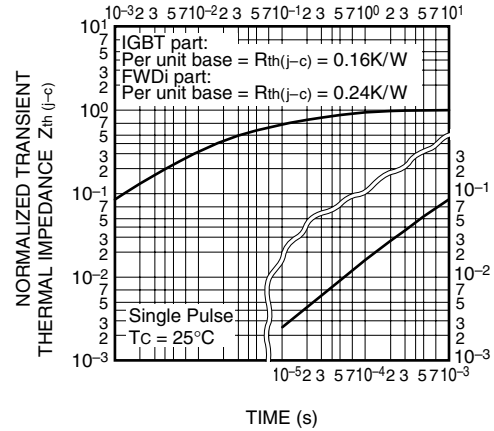

GATE CHARGE CHARACTERISTICS (TYPICAL)

