

2MBI200N-060-03

IGBT Module

600V / 200A 2 in one-package

■ Features

- VCE(sat) classified for easy parallel connection
- High speed switching
- Voltage drive
- Low inductance module structure

■ Applications

- Inverter for Motor drive
- AC and DC Servo drive amplifier
- Uninterruptible power supply
- Industrial machines, such as Welding machines

■ Maximum ratings and characteristics

● Absolute maximum ratings (at Tc=25°C unless otherwise specified)

Item	Symbol	Rating	Unit
Collector-Emitter voltage	V _{CES}	600	V
Gate-Emitter voltage	V _{GES}	±20	V
Collector current	Continuous	I _c	200
	1ms	I _c pulse	400
		-I _c	200
	1ms	-I _c pulse	400
Max. power dissipation	P _c	780	W
Operating temperature	T _j	+150	°C
Storage temperature	T _{stg}	-40 to +125	°C
Isolation voltage	V _{is}	AC 2500 (1min.)	V
Screw torque	Mounting *1	3.5	N·m
	Terminals *1	3.5	N·m

*1 : Recommendable value : 2.5 to 3.5 N·m(M5)

● Electrical characteristics (at Tj=25°C unless otherwise specified)

Item	Symbol	Characteristics			Conditions	Unit
		Min.	Typ.	Max.		
Zero gate voltage collector current	I _{CES}	-	-	2.0	V _{GE} =0V, V _{CES} =600V	mA
Gate-Emitter leakage current	I _{GES}	-	-	30	V _{CES} =0V, V _{GES} =±20V	µA
Gate-Emitter threshold voltage	V _{GE(th)}	4.5	-	7.5	V _{CES} =20V, I _c =200mA	V
Collector-Emitter saturation voltage	V _{CES(sat)}	-	-	2.8	V _{GE} =15V, I _c =200A	V
Input capacitance	C _{ies}	-	13200	-	V _{GE} =0V	pF
Output capacitance	C _{oes}	-	2930	-	V _{CES} =10V	
Reverse transfer capacitance	C _{res}	-	1330	-	f=1MHz	
Turn-on time	t _{on}	-	0.6	1.2	V _{CC} =300V	µs
	t _r	-	0.2	0.6	I _c =200A	
Turn-off time	t _{off}	-	0.6	1.0	V _{GE} =±15V	
	t _f	-	0.2	0.35	R _G =9.1ohm	
Diode forward on voltage	V _F	-	-	3.0	I _F =200A, V _{GE} =0V	V
Reverse recovery time	t _{rr}	-	-	0.3	I _F =200A	µs

● Thermal resistance characteristics

Item	Symbol	Characteristics			Conditions	Unit
		Min.	Typ.	Max.		
Thermal resistance	R _{th(j-c)}	-	-	0.16	IGBT	°C/W
	R _{th(j-c)}	-	-	0.35	Diode	°C/W
	R _{th(c-f)*2}	-	0.025	-	the base to cooling fin	°C/W

*2 : This is the value which is defined mounting on the additional cooling fin with thermal compound



■ Equivalent Circuit Schematic

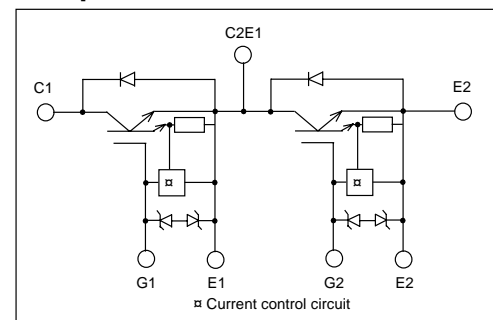

● VCE(sat) classification

Rank	Lenge	Conditions
F	1.85 to 2.10V	I _c = 200A V _{GE} = 15V T _j = 25°C
A	2.00 to 2.25V	
B	2.15 to 2.40V	
C	2.30 to 2.60V	
D	2.50 to 2.80V	

■ Characteristics (Representative)

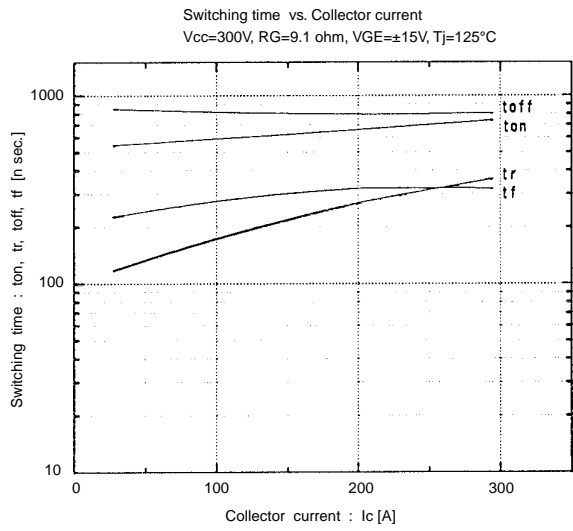
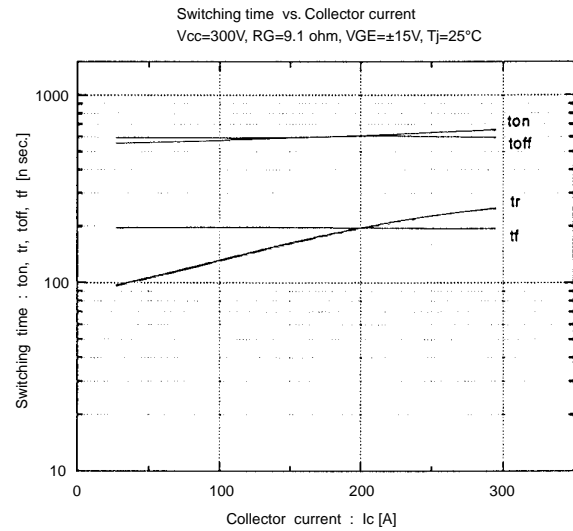
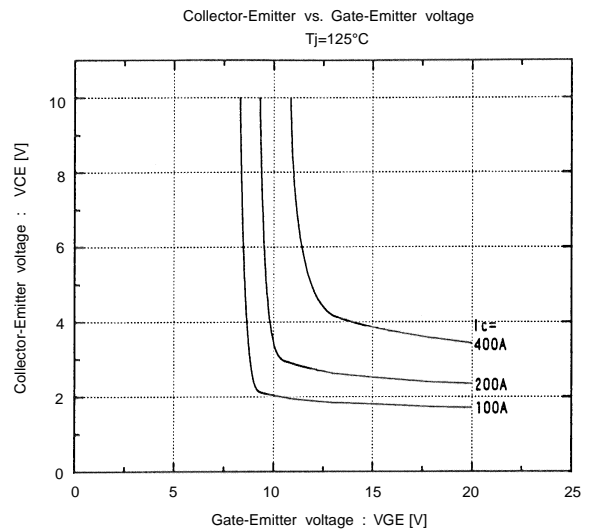
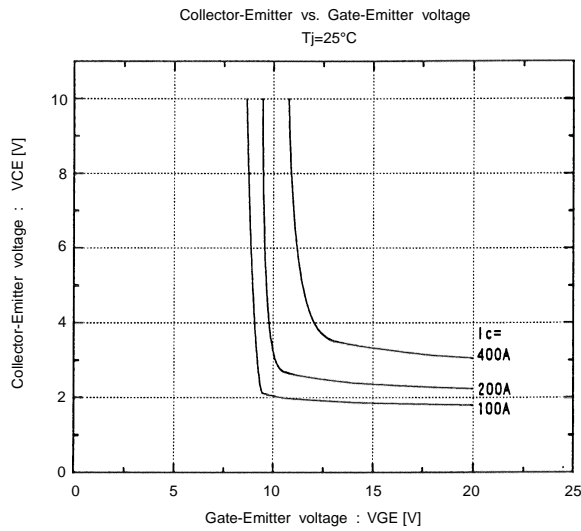
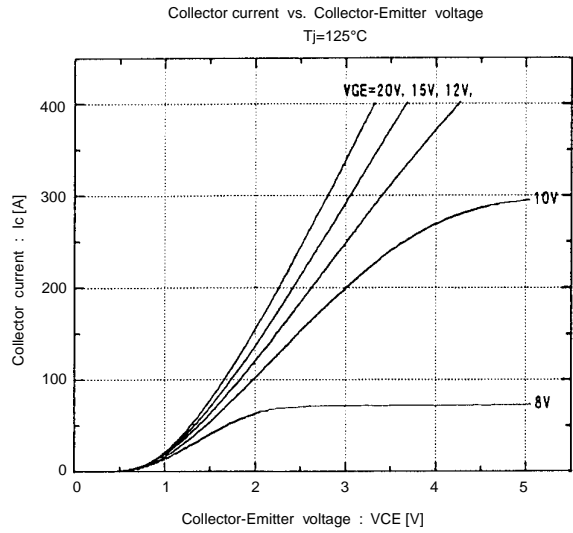
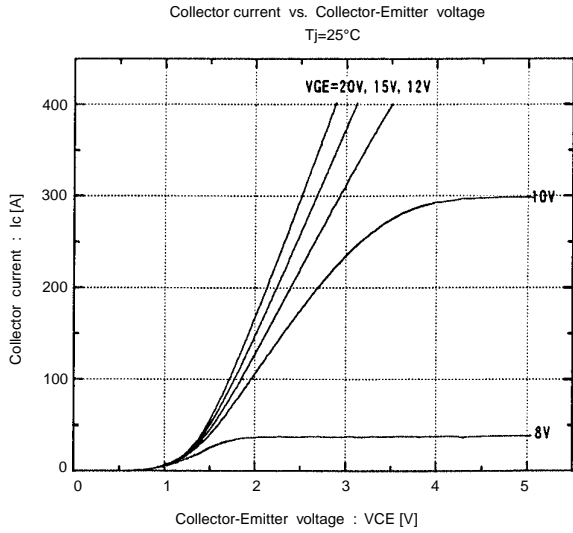

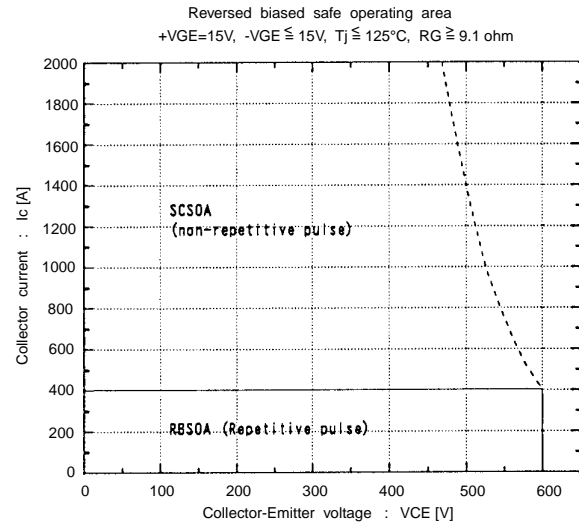
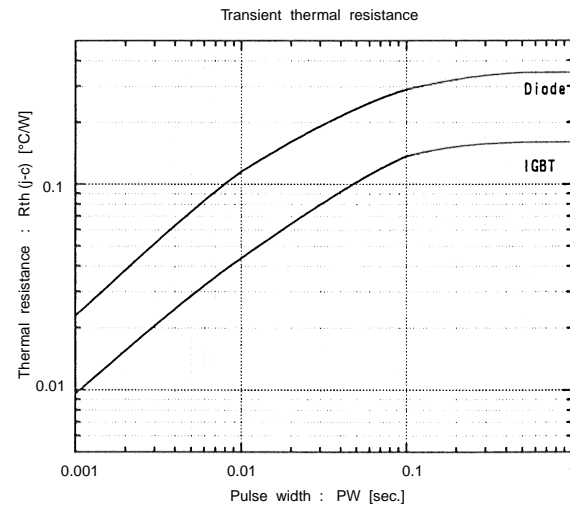
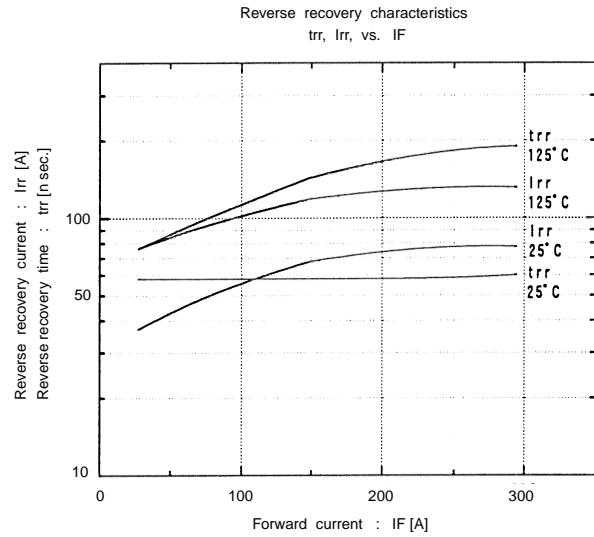
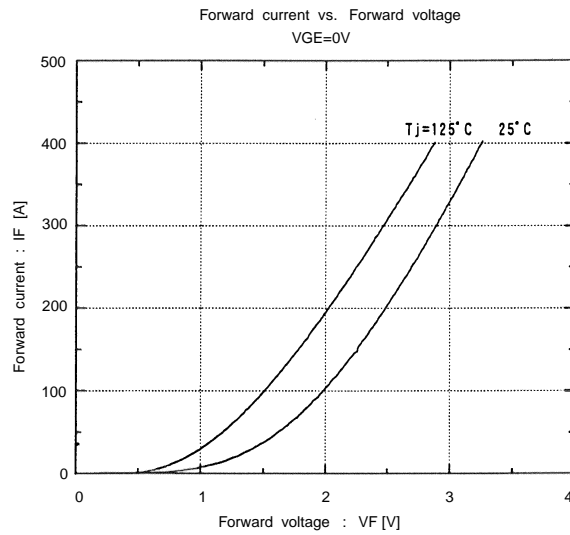
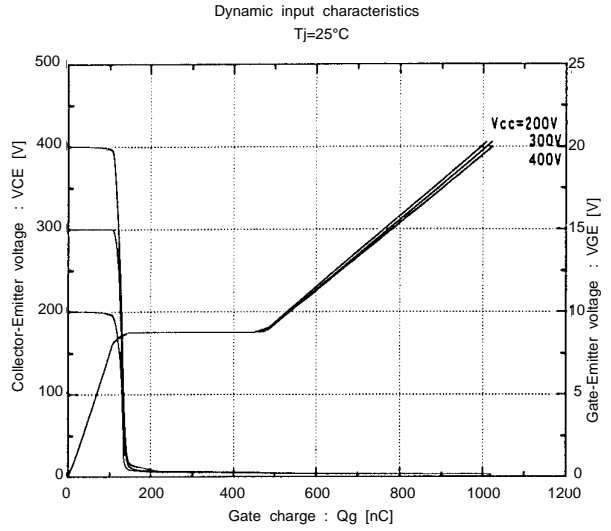
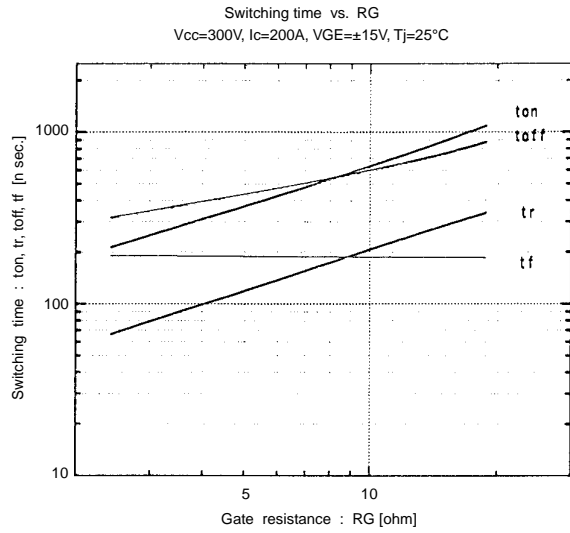

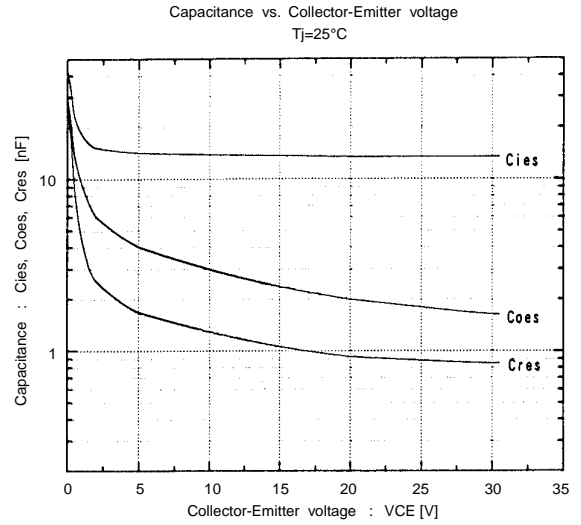
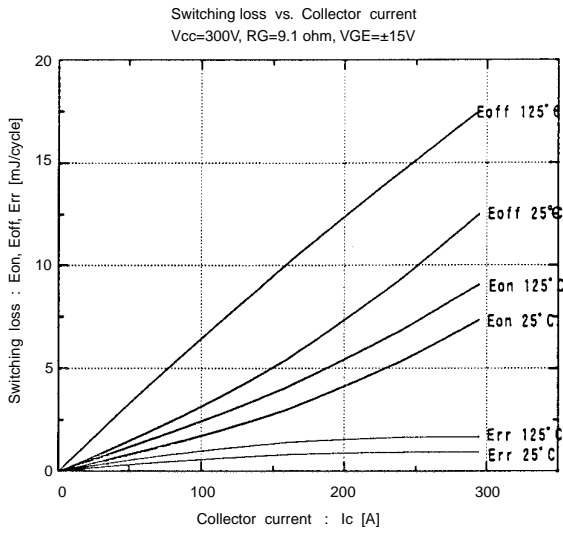

■ Outline Drawings, mm

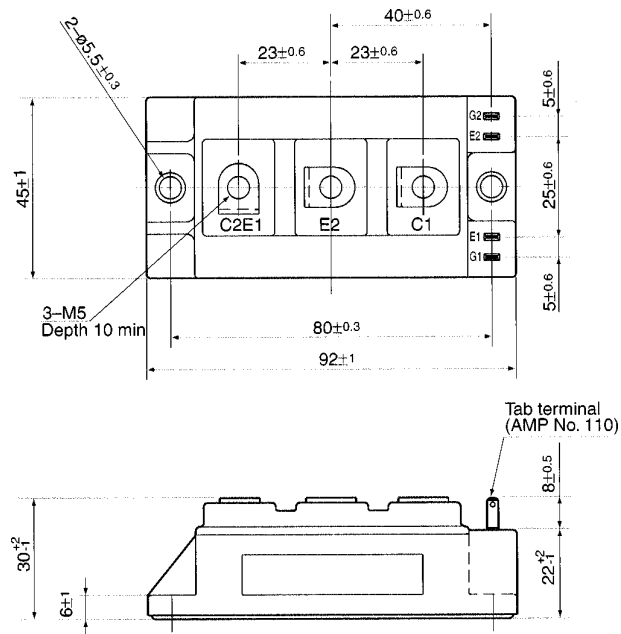

Mass : 240g