



■ General Description

The AME8805/8810 family of positive, linear regulators feature low quiescent current (30 μ A typ.) with low dropout voltage, making them ideal for battery applications. The space-saving SOT-89 and SOT-223 packages are attractive for "Pocket" and "Hand Held" applications.

These rugged devices have both Thermal Shutdown, and Current Fold-back to prevent device failure under the "Worst" of operating conditions.

The AME8805/8810 is stable with an output capacitance of 2.2 μ F or greater.

■ Features

- Very Low Dropout Voltage
- Guaranteed 600mA Output
- Accurate to within 1.5%
- 30 μ A Quiescent Current
- Over-Temperature Shutdown
- Current Limiting
- Short Circuit Current Fold-back
- Space-Saving SOT-89 Package
- Factory Pre-set Output Voltages
- Low Temperature Coefficient

■ Functional Block Diagram

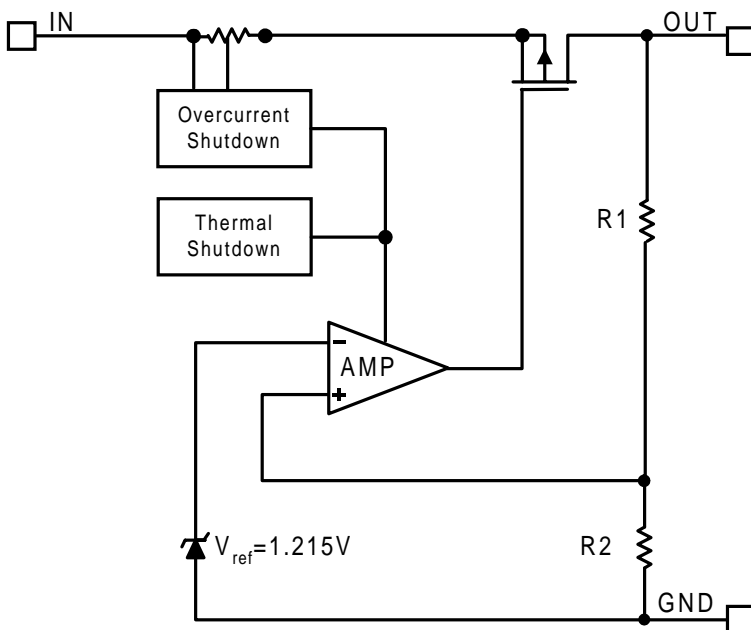

■ Applications

- Instrumentation
- Portable Electronics
- Wireless Devices
- Cordless Phones
- PC Peripherals
- Battery Powered Widgets
- Electronic Scales

■ Typical Application

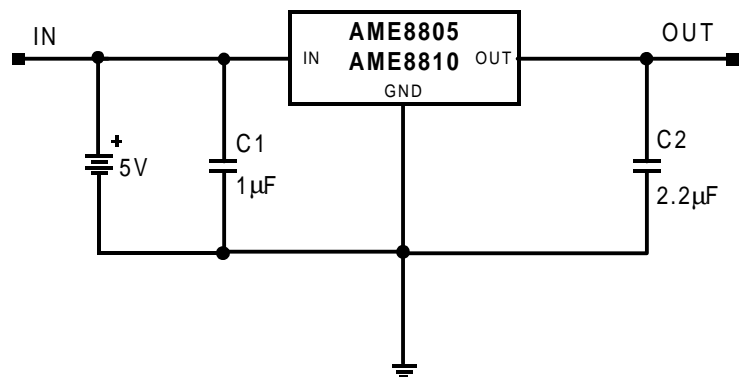



■ Pin Configuration

SOT-89 Top View

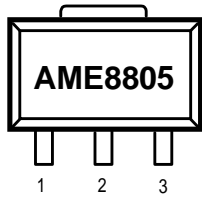

- 1. GND
- 2. V_{IN}
- 3. V_{OUT}

SOT-223 Top View

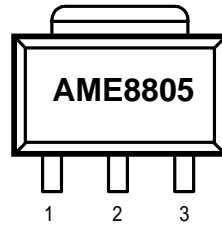

- 1. V_{IN}
- 2. GND
- 3. V_{OUT}

SOT-223 Top View

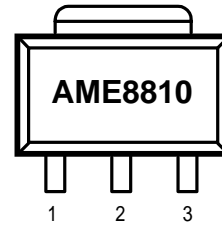

- 1. GND
- 2. V_{OUT}
- 3. V_{IN}



■ Ordering Information

Part Number	Marking	Output	Package	Temperature
AME8805AEFT	A8805 AEFw w	3.3V	SOT-89	-40°C to +85°C
AME8805BEFT	A8805 BEFw w	3.0V	SOT-89	-40°C to +85°C
AME8805CEFT	A8805 CEFw w	2.8V	SOT-89	-40°C to +85°C
AME8805DEFT	A8805 DEFw w	2.5V	SOT-89	-40°C to +85°C
AME8805FEFT	A8805 FEFw w	3.6V	SOT-89	-40°C to +85°C
AME8805GEFT	A8805 GEFw w	3.5V	SOT-89	-40°C to +85°C
AME8805HEFT	A8805 HEFw w	2.7V	SOT-89	-40°C to +85°C
AME8805IEFT	A8805 IEFw w	3.4V	SOT-89	-40°C to +85°C
AME8805JEFT	A8805 JEFw w	2.85V	SOT-89	-40°C to +85°C
AME8805KEFT	A8805 KEFw w	3.7V	SOT-89	-40°C to +85°C
AME8805LEFT	A8805 LEFw w	1.5V	SOT-89	-40°C to +85°C
AME8805MEFT	A8805 MEFw w	1.8V	SOT-89	-40°C to +85°C
AME8805NEFT	A8805 NEFw w	2.9V	SOT-89	-40°C to +85°C
AME8805OEFT	A8805 OEFw w	3.1V	SOT-89	-40°C to +85°C
AME8805AEGT	ADBw w	3.3V	SOT-223	-40°C to +85°C
AME8805BEGT	ADCw w	3.0V	SOT-223	-40°C to +85°C
AME8805CEGT	ADDw w	2.8V	SOT-223	-40°C to +85°C
AME8805DEGT	ADEw w	2.5V	SOT-223	-40°C to +85°C
AME8805EEGT	ADFw w	3.8V	SOT-223	-40°C to +85°C
AME8805FEGT	ADGw w	3.6V	SOT-223	-40°C to +85°C
AME8805GEGT	ADHw w	3.5V	SOT-223	-40°C to +85°C
AME8805HEGT	AJyw w	2.7V	SOT-223	-40°C to +85°C
AME8805IEGT	AERYw w	3.4V	SOT-223	-40°C to +85°C
AME8805JEGT	AGTyw w	2.85V	SOT-223	-40°C to +85°C
AME8805KEGT	AHVyw w	3.7V	SOT-223	-40°C to +85°C
AME8805MEGT	AJJyw w	1.8V	SOT-223	-40°C to +85°C
AME8805NEGT	AKSyw w	2.9V	SOT-223	-40°C to +85°C
AME8805OEGT	AKTyw w	3.1V	SOT-223	-40°C to +85°C



■ Ordering Information

Part Number	Marking	Output	Package	Temperature
AME8810AEGT	ADlyw w	3.3V	SOT-223	-40°C to +85°C
AME8810BEGT	ADJyw w	3.0V	SOT-223	-40°C to +85°C
AME8810CEGT	ADKyw w	2.8V	SOT-223	-40°C to +85°C
AME8810DEGT	ADLyw w	2.5V	SOT-223	-40°C to +85°C
AME8810EEGT	ADMyw w	3.8V	SOT-223	-40°C to +85°C
AME8810FEGT	ADNyw w	3.6V	SOT-223	-40°C to +85°C
AME8810GEGT	ADOyw w	3.5V	SOT-223	-40°C to +85°C
AME8810HEGT	AEKyw w	2.7V	SOT-223	-40°C to +85°C
AME8810IEGT	AESyw w	3.4V	SOT-223	-40°C to +85°C
AME8810JEGT	AGVyw w	2.85V	SOT-223	-40°C to +85°C
AME8810KEGT	AHXyw w	3.7V	SOT-223	-40°C to +85°C
AME8810LEGT	AJFyw w	1.5V	SOT-223	-40°C to +85°C
AME8810MEGT	AJGyw w	1.8V	SOT-223	-40°C to +85°C
AME8810NEGT	AKWyw w	2.9V	SOT-223	-40°C to +85°C
AME8810OEGT	AKXyw w	3.1V	SOT-223	-40°C to +85°C

Please consult AME sales office or authorized Rep./Distributor for other output voltage and package type availability.



■ Absolute Maximum Ratings

Parameter	Maximum	Unit
Input Voltage	8	V
Output Current	1	A
Input, Output Voltage	GND - 0.3 to $V_{IN} + 0.3$	V
ESD Classification	B	

■ Recommended Operating Conditions

Parameter	Rating	Unit
Supply Voltage	4.5 to 5.5	V
Ambient Temperature Range	-40 to +85	°C
Junction Temperature	-40 to +125	°C

■ Thermal Information

Parameter		Maximum	Unit
Thermal Resistance (θ_{ja})	SOT-89	180	°C / W
	SOT-223	160	
Thermal Resistance (θ_{jc})	SOT-89	18	°C / W
	SOT-223	15	
Internal Power Dissipation (P_D) ($\Delta T = 100^\circ\text{C}$, No Heat Sink)	SOT-89	550	mW
	SOT-223	625	
Internal Power Dissipation (P_D) ($\Delta T = 100^\circ\text{C}$, With Heat Sink)	SOT-89	2750*	mW
	SOT-223	3300*	
Maximum Junction Temperature		150	°C
Maximum Lead Temperature (10 Sec)		300	°C

* Using twice the θ_{jc} for this calculation.

Caution: Stress above the listed absolute rating may cause permanent damage to the device



■ Electrical Specifications

TA = 25°C unless otherwise noted

Parameter	Symbol	Test Condition	Min	Typ	Max	Units	
Input Voltage	V_{IN}		Note 1		7	V	
Output Voltage Accuracy	V_O	$I_O=1mA$	-1.5		1.5	%	
Dropout Voltage	$V_{DROPOUT}$	$I_O=600mA$ $V_O=V_{ONOM}-2.0%$	$1.4V < V_{O(NOM)} \leq 2.0V$	See chart	1400	mV	
			$2.0V < V_{O(NOM)} \leq 2.8V$		800		
			$2.8V < V_{O(NOM)}$		600		
Output Current	I_O	$V_O > 1.2V$	600			mA	
Current Limit	I_{LIM}	$V_O > 1.2V$	600	800		mA	
Short Circuit Current	I_{SC}	$V_O < 0.8V$		300	600	mA	
Quiescent Current	I_Q	$I_O=0mA$		30	50	μA	
Ground Pin Current	I_{GND}	$I_O=1mA$ to 600mA		35		μA	
Line Regulation	REG_{LINE}	$I_O=5mA$ $V_{IN}=V_O+1$ to V_O+2	$V_O < 2.0V$	-0.15		0.15	%
			$4.0V > V_O \geq 2.0V$	-0.1	0.02	0.1	%
			$V_O \geq 4.0V$	-0.4		0.4	%
Load Regulation	REG_{LOAD}	$I_O=1mA$ to 600mA		0.2	1	%	
Over Temperature Shutdown	OTS			150		$^{\circ}C$	
Over Temperature Hysteresis	OTH			30		$^{\circ}C$	
V_O Temperature Coefficient	TC			30		ppm/ $^{\circ}C$	
Power Supply Rejection	PSRR	$I_O=100mA$ $C_O=2.2\mu F$	$f=1kHz$		50	dB	
			$f=10kHz$		20		
			$f=100kHz$		15		
Output Voltage Noise	eN	$f=10Hz$ to 100kHz $I_O=10mA, C_{BYP}=0\mu F$	$C_O=2.2\mu F$		30	μV_{rms}	

Note1: $V_{IN(min)} = V_{OUT} + V_{DROPOUT}$



■ Detailed Description

The AME8805/8810 family of CMOS regulators contain a PMOS pass transistor, voltage reference, error amplifier, over-current protection, and thermal shutdown.

The P-channel pass transistor receives data from the error amplifier, over-current shutdown, and thermal protection circuits. During normal operation, the error amplifier compares the output voltage to a precision reference. Over-current and Thermal shutdown circuits become active when the junction temperature exceeds 150°C, or the current exceeds 600mA. During thermal shutdown, the output voltage remains low. Normal operation is restored when the junction temperature drops below 120°C.

The AME8805/8810 switches from voltage mode to current mode when the load exceeds the rated output current. This prevents over-stress. The AME8805/8810 also incorporates current foldback to reduce power dissipation when the output is short circuited. This feature becomes active when the output drops below 0.8 volts, and reduces the current flow by 65%. Full current is restored when the voltage exceeds 0.8 volts.

■ External Capacitors

The AME8805/8810 is stable with an output capacitor to ground of 2.2 μ F or greater. Ceramic capacitors have the lowest ESR, and will offer the best AC performance. Conversely, Aluminum Electrolytic capacitors exhibit the highest ESR, resulting in the poorest AC response. Unfortunately, large value ceramic capacitors are comparatively expensive. One option is to parallel a 0.1 μ F ceramic capacitor with a 10 μ F Aluminum Electrolytic. The benefit is low ESR, high capacitance, and low overall cost.

A second capacitor is recommended between the input and ground to stabilize V_{in} . The input capacitor should be at least 0.1 μ F to have a beneficial effect.

All capacitors should be placed in close proximity to the pins. A "Quiet" ground termination is desirable. This can be achieved with a "Star" connection.

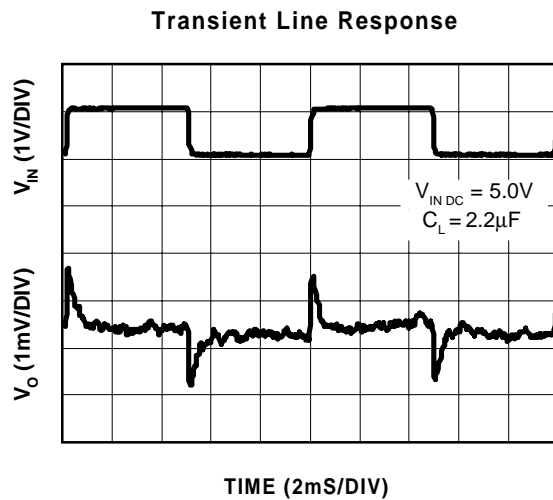
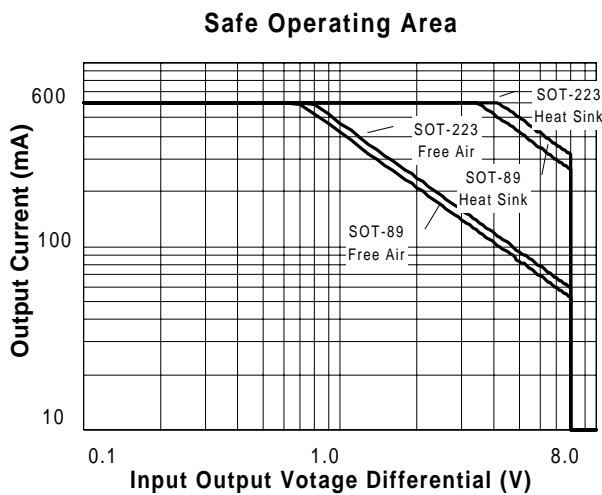
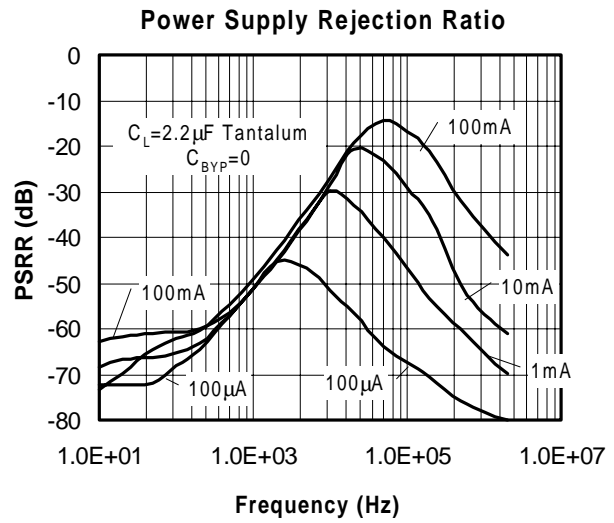
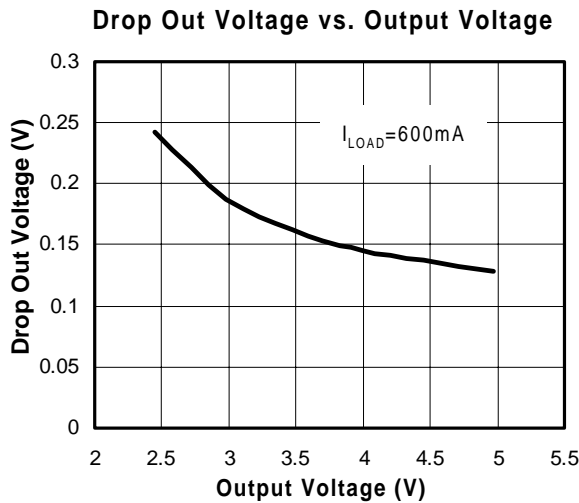
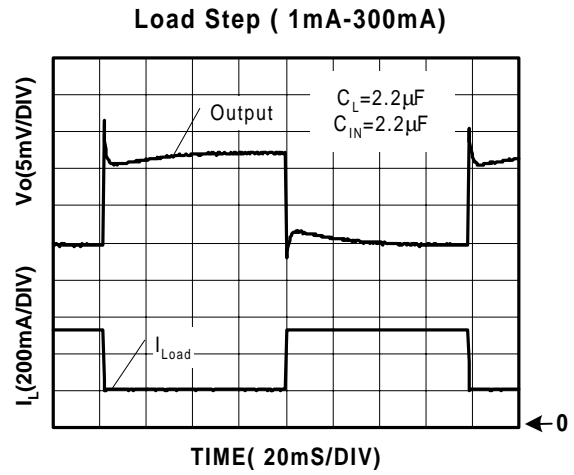
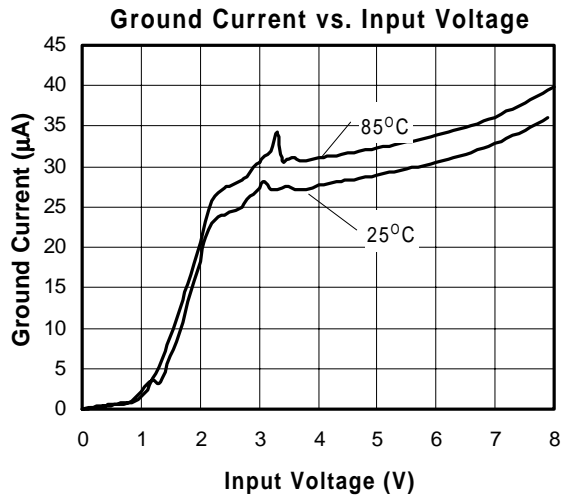



Noise Measurement

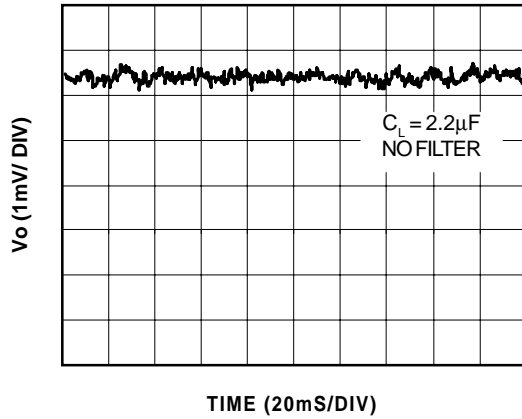

Overtemperature Shutdown

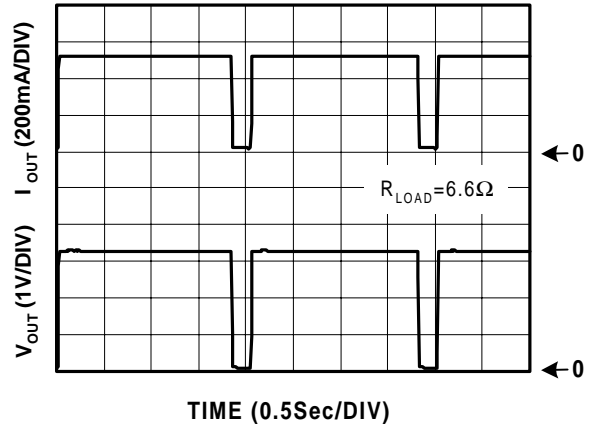

Current Limit Response

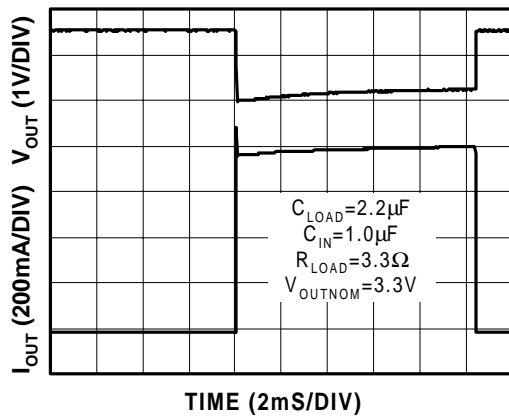

Short Circuit Response

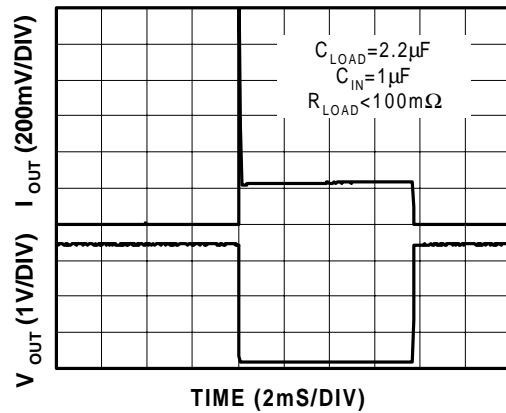



■ Package Dimension

SOT-89

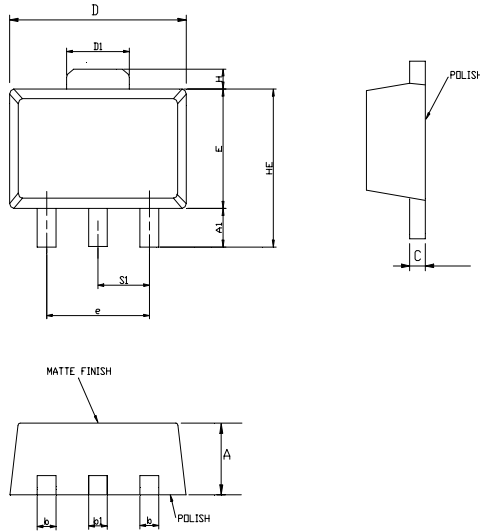

SYMBOLS	MILLIMETERS		INCHES	
	MIN	MAX	MIN	MAX
A	1.40	1.60	0.0551	0.0630
A ₁	0.89	-	0.0350	-
b	0.36	0.52	0.0142	0.0205
b ₁	0.41	0.56	0.0161	0.0220
C	0.35	0.44	0.0138	0.0173
D	4.40	4.60	0.1732	0.1811
D ₁	1.35	1.83	0.0531	0.0720
HE	-	4.25	-	0.1673
E	2.29	2.60	0.0902	0.1024
e	2.90	3.10	0.1142	0.1220
H	0.35	0.70	0.0138	0.0276
SI	1.40	1.60	0.0551	0.0630

SOT-223

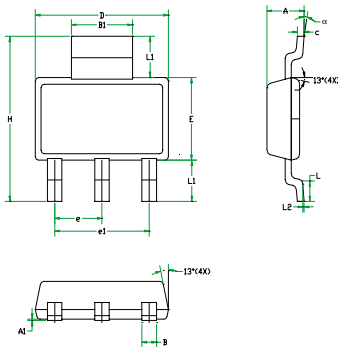

SYMBOLS	MILLIMETERS		INCHES	
	MIN	MAX	MIN	MAX
A	1.50	1.80	0.0591	0.0709
A ₁	0.02	0.10	0.0008	0.0039
B	0.60	0.838	0.0236	0.033
B ₁	2.895	3.15	0.1140	0.1240
C	0.24	0.381	0.0094	0.0150
D	6.299	6.706	0.2480	0.2640
E	3.30	3.708	0.1299	0.1460
e	2.30 BSC		0.090 BSC	
e ₁	4.60 BSC		0.181 BSC	
H	6.70	7.30	0.2638	0.2874
L	0.91 MIN		0.0360 MIN	
L ₁	2.00 MAX		0.0787 MAX	
L ₂	0.06 BSC		0.0024 BSC	
α	0°	10°	0°	10°



www.analogmicro.com
E-Mail: info@analogmicro.com

Life Support Policy:

These products of Analog Microelectronics, Inc. are not authorized for use as critical components in life-support devices or systems, without the express written approval of the president of Analog Microelectronics, Inc.

Analog Microelectronics, Inc. reserves the right to make changes in the circuitry and specifications of its devices and advises its customers to obtain the latest version of relevant information.

© Analog Microelectronics, Inc. , August 2001

Document: 2006-DS8805/8810-E

Corporate Headquarters
Analog Microelectronics, Inc.

3100 De La Cruz Blvd. Suite 201
Santa Clara, CA. 95054-2046
Tel : (408) 988-2388
Fax: (408) 988-2489

Asia Pacific Headquarters
AME, Inc.

2F, 187 Kang-Chien Road, Nei-Hu District
Taipei 114, Taiwan, R.O.C.
Tel : 886 2 2627-8687
Fax: 886 2 2659-2989