

Three Phase Rectifier Bridge

$I_{dAV} = 37 \text{ A}$
 $V_{RRM} = 800-1800 \text{ V}$

V_{RSM} V	V_{RRM} V	Type
900	800	VUO 30-08NO3
1300	1200	VUO 30-12NO3
1500	1400	VUO 30-14NO3
1700	1600	VUO 30-16NO3
1900	1800	VUO 30-18NO3*

* delivery time on request

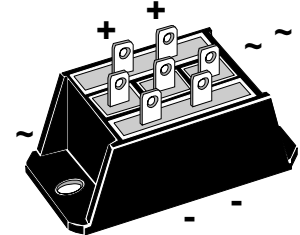
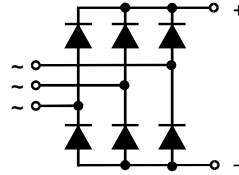

Symbol	Test Conditions	Maximum Ratings
I_{dAV} ①	$T_C = 85^\circ\text{C}$, module	37 A
I_{dAVM} ①	module	50 A
I_{FSM}	$T_{VJ} = 45^\circ\text{C}$; $V_R = 0$	t = 10 ms (50 Hz), sine 300 A t = 8.3 ms (60 Hz), sine 330 A
	$T_{VJ} = T_{VJM}$; $V_R = 0$	t = 10 ms (50 Hz), sine 270 A t = 8.3 ms (60 Hz), sine 290 A
I^2t	$T_{VJ} = 45^\circ\text{C}$; $V_R = 0$	t = 10 ms (50 Hz), sine 450 A ² s t = 8.3 ms (60 Hz), sine 460 A ² s
	$T_{VJ} = T_{VJM}$; $V_R = 0$	t = 10 ms (50 Hz), sine 365 A ² s t = 8.3 ms (60 Hz), sine 355 A ² s
T_{VJ}		-40...+125 °C
T_{VJM}		125 °C
T_{stg}		-40...+125 °C
V_{ISOL}	50/60 Hz, RMS	t = 1 min 3000 V~ t = 1 s 3600 V~
	$I_{ISOL} \leq 1 \text{ mA}$	
M_d	Mounting torque (M5) (10-32 UNF)	2-2.5 Nm
		18-22 lb.in.
Weight	typ.	50 g

Features

- Package with DCB ceramic base plate
- Isolation voltage 3600 V~
- Planar passivated chips
- Blocking voltage up to 1800 V
- Low forward voltage drop
- 1/4" fast-on terminals
- UL registered E 72873

Applications

- Supplies for DC power equipment
- Input rectifiers for PWM inverter
- Battery DC power supplies
- Rectifier for DC motors field current

Advantages

- Easy to mount with two screws
- Space and weight savings
- Improved temperature and power cycling

Dimensions in mm (1 mm = 0.0394")

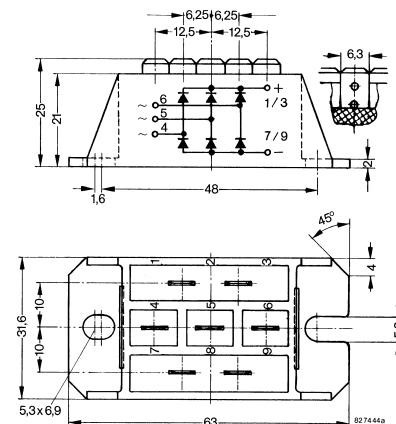

Symbol	Test Conditions	Characteristic Values
I_R	$V_R = V_{RRM}$; $T_{VJ} = 25^\circ\text{C}$	0.3 mA
	$V_R = V_{RRM}$; $T_{VJ} = T_{VJM}$	5 mA
V_F	$I_F = 150 \text{ A}$; $T_{VJ} = 25^\circ\text{C}$	2.55 V
V_{T0}	For power-loss calculations only	0.9 V
r_T		11 mΩ
R_{thJC}	per diode, DC current	2.4 K/W
	per module	0.4 K/W
R_{thJH}	per diode, DC current	3.0 K/W
	per module	0.5 K/W
d_s	Creeping distance on surface	10 mm
d_A	Creepage distance in air	9.4 mm
a	Max. allowable acceleration	50 m/s ²

Data according to IEC 60747 and refer to a single diode unless otherwise stated.

① for resistive load at bridge output

IXYS reserves the right to change limits, test conditions and dimensions.

Use output terminals in parallel connection!

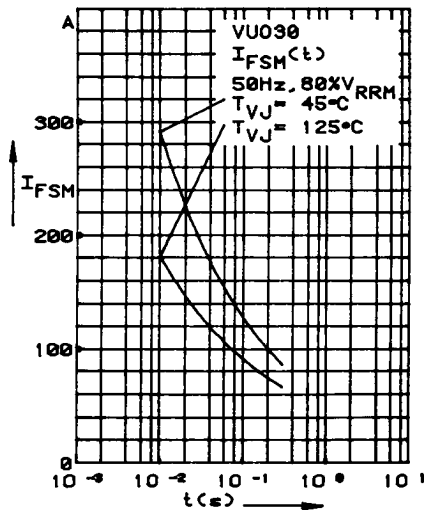

Fig. 1 Surge overload current
 I_{FSM} : Crest value, t : duration

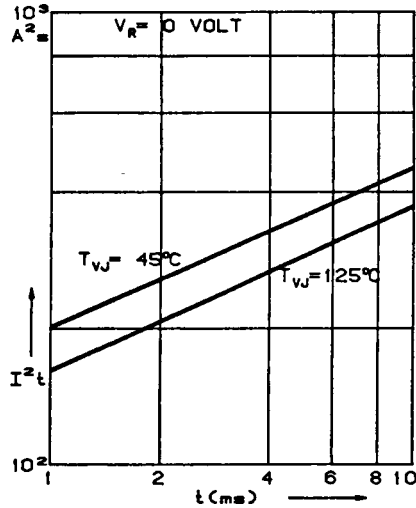

Fig. 2 I^2t versus time (1-10 ms)

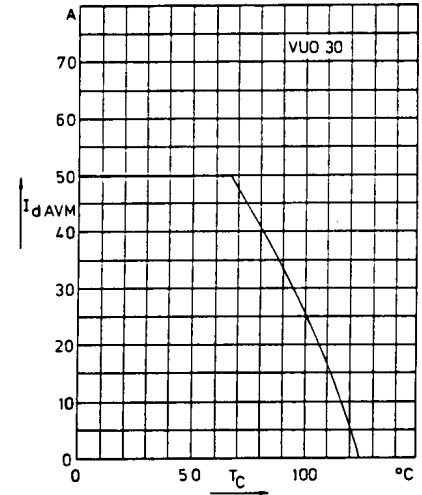

Fig. 3 Max. forward current at case temperature

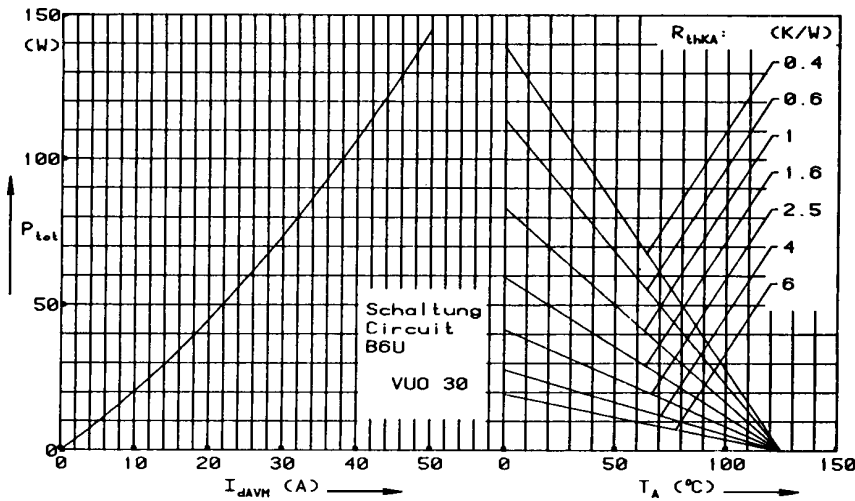

Fig. 4 Power dissipation versus forward current and ambient temperature

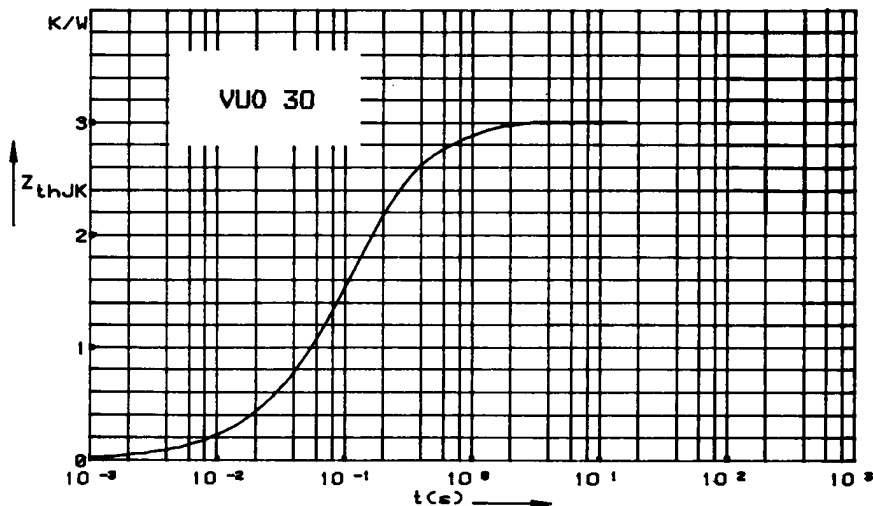

Fig. 5 Transient thermal impedance junction to heatsink per diode

Constants for Z_{thJK} calculation:

i	R_{thi} (K/W)	t_i (s)
1	0.489	0.0717
2	0.544	0.1241
3	1.376	0.1214
4	0.6	0.620