

# Diode Modules

$$I_{FRMS} = 2 \times 180 \text{ A}$$

$$I_{FAVM} = 2 \times 120 \text{ A}$$

$$V_{RRM} = 800\text{-}2200 \text{ V}$$

$V_{RSM}$ V	$V_{RRM}$ V	Type
900	800	MDD 95-08N1 B
1300	1200	MDD 95-12N1 B
1500	1400	MDD 95-14N1 B
1700	1600	MDD 95-16N1 B
1900	1800	MDD 95-18N1 B
2100	2000	MDD 95-20N1 B
2300	2200	MDD 95-22N1 B

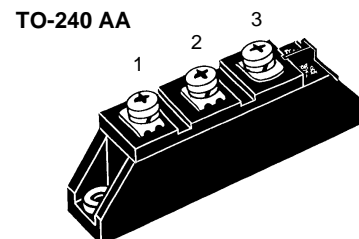
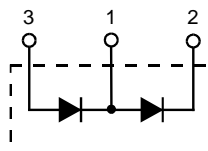

Symbol	Test Conditions	Maximum Ratings
$I_{FRMS}$	$T_{VJ} = T_{VJM}$	180 A
$I_{FAVM}$	$T_C = 105^\circ\text{C}; 180^\circ \text{ sine}$	120 A
$I_{FSM}$	$T_{VJ} = 45^\circ\text{C}; V_R = 0$	t = 10 ms (50 Hz), sine 2800 A t = 8.3 ms (60 Hz), sine 3300 A
	$T_{VJ} = T_{VJM}; V_R = 0$	t = 10 ms (50 Hz), sine 2500 A t = 8.3 ms (60 Hz), sine 2750 A
$\int i^2 dt$	$T_{VJ} = 45^\circ\text{C}; V_R = 0$	t = 10 ms (50 Hz), sine 39 200 A <sup>2</sup> s t = 8.3 ms (60 Hz), sine 45 000 A <sup>2</sup> s
	$T_{VJ} = T_{VJM}; V_R = 0$	t = 10 ms (50 Hz), sine 31 200 A <sup>2</sup> s t = 8.3 ms (60 Hz), sine 31 300 A <sup>2</sup> s
$T_{VJ}$		-40...+150 °C
$T_{VJM}$		150 °C
$T_{stg}$		-40...+125 °C
$V_{ISOL}$	50/60 Hz, RMS	t = 1 min 3000 V~
	$I_{ISOL} \leq 1 \text{ mA}$	t = 1 s 3600 V~
$M_d$	Mounting torque (M5)	2.5-4/22-35 Nm/lb.in.
	Terminal connection torque (M5)	2.5-4/22-35 Nm/lb.in.
Weight	Typical including screws	90 g

### Features

- International standard package JEDEC TO-240 AA
- Direct copper bonded Al<sub>2</sub>O<sub>3</sub> -ceramic base plate
- Planar passivated chips
- Isolation voltage 3600 V~
- UL registered, E 72873

### Applications

- Supplies for DC power equipment
- DC supply for PWM inverter
- Field supply for DC motors
- Battery DC power supplies

### Advantages

- Space and weight savings
- Simple mounting
- Improved temperature and power cycling
- Reduced protection circuits

Symbol	Test Conditions	Characteristic Values	
$I_R$	$T_{VJ} = T_{VJM}; V_R = V_{RRM}$	15 mA	
$V_F$	$I_F = 300 \text{ A}; T_{VJ} = 25^\circ\text{C}$	1.43 V	
$V_{TO}$	For power-loss calculations only	0.75 V	
$r_T$	$T_{VJ} = T_{VJM}$	1.95 mΩ	
$Q_s$	$T_{VJ} = 125^\circ\text{C}; I_F = 50 \text{ A}, -di/dt = 6 \text{ A}/\mu\text{s}$	170 μC	
$I_{RM}$		45 A	
$R_{thJC}$	per diode; DC current	} other values see Fig. 6/7	
	per module		0.26 K/W
$R_{thJK}$	per diode; DC current		0.13 K/W
	per module		0.46 K/W
$d_s$	Creepage distance on surface	12.7 mm	
$d_A$	Strike distance through air	9.6 mm	
$a$	Maximum allowable acceleration	50 m/s <sup>2</sup>	

### Dimensions in mm (1 mm = 0.0394")

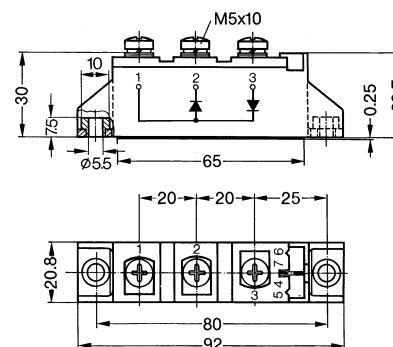

Data according to IEC 60747 and refer to a single diode unless otherwise stated. IXYS reserves the right to change limits, test conditions and dimensions

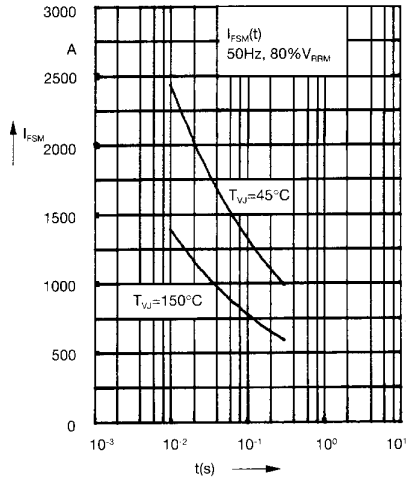

Fig. 1 Surge overload current  
 $I_{FSM}$ : Crest value, t: duration

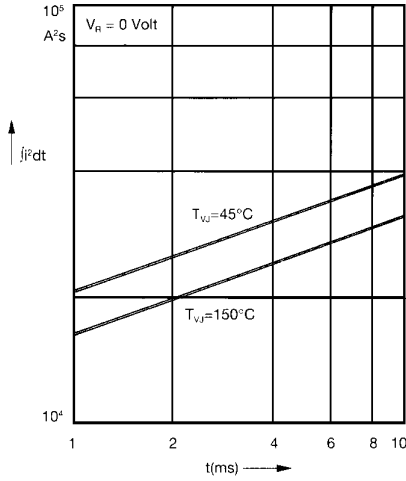

Fig. 2  $j^2dt$  versus time (1-10 ms)

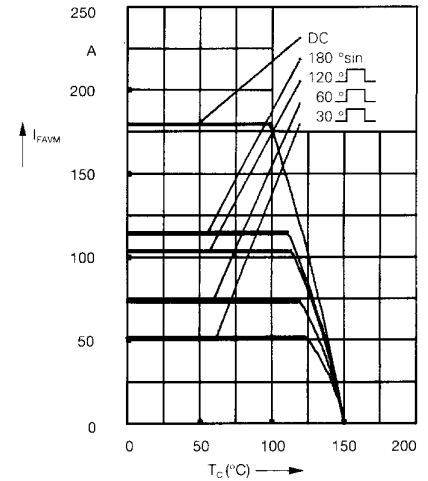

Fig. 2a Maximum forward current at case temperature

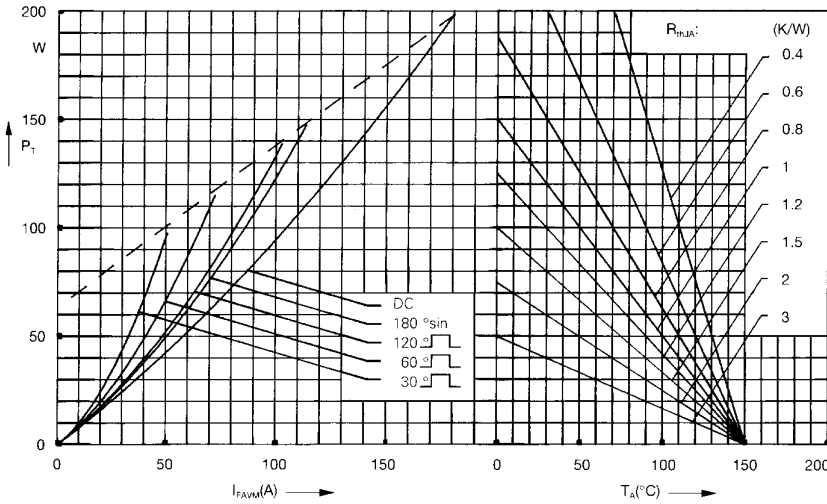

Fig. 3 Power dissipation versus forward current and ambient temperature (per diode)

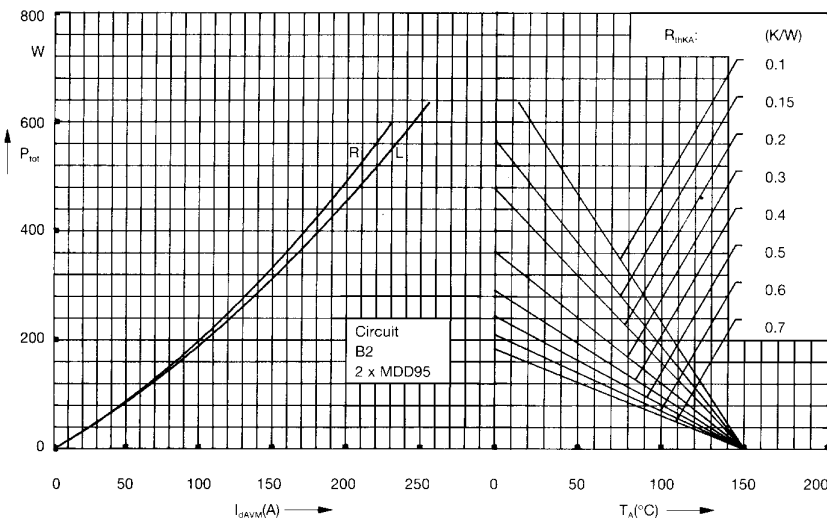

Fig. 4 Single phase rectifier bridge:  
Power dissipation versus direct output current and ambient temperature  
R = resistive load  
L = inductive load

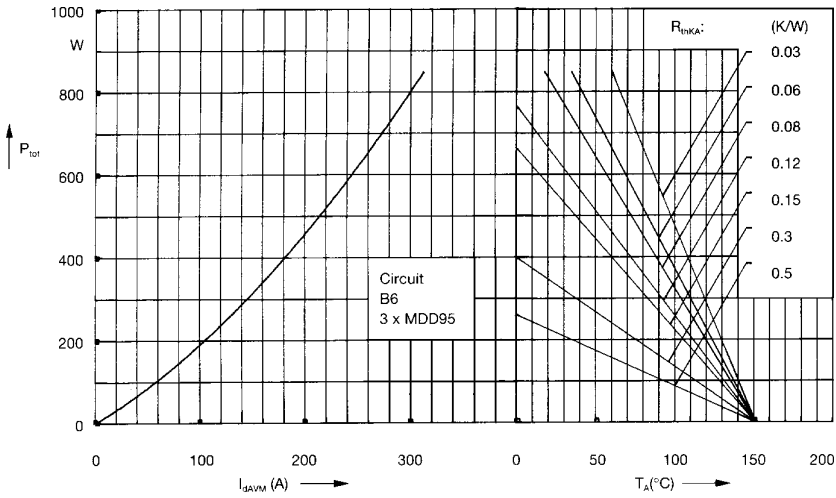

Fig. 5 Three phase rectifier bridge: Power dissipation versus direct output current and ambient temperature

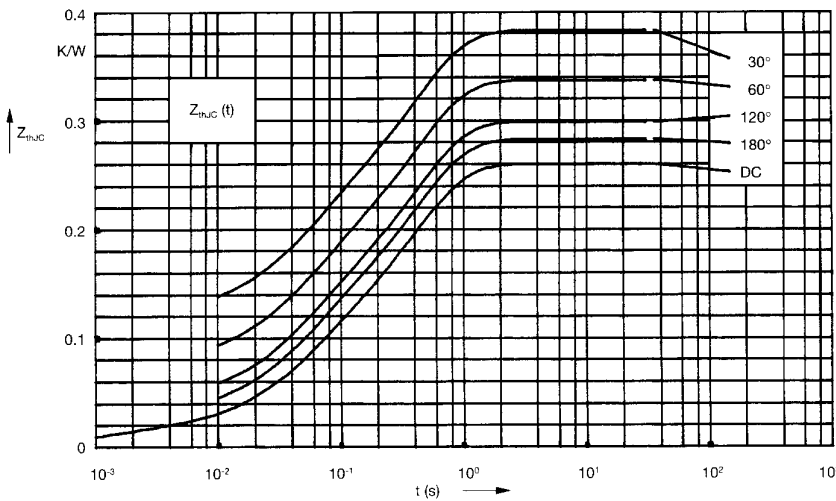

Fig. 6 Transient thermal impedance junction to case (per diode)

$R_{thJC}$  for various conduction angles d:

d	$R_{thJC}$ (K/W)
DC	0.26
180°	0.28
120°	0.30
60°	0.34
30°	0.38

Constants for  $Z_{thJC}$  calculation:

i	$R_{thi}$ (K/W)	$t_i$ (s)
1	0.013	0.0012
2	0.072	0.047
3	0.175	0.394

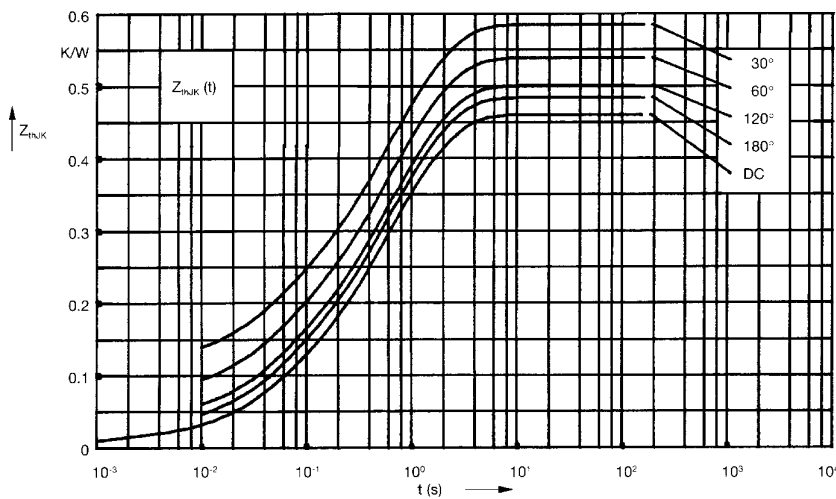

Fig. 7 Transient thermal impedance junction to heatsink (per diode)

$R_{thJK}$  for various conduction angles d:

d	$R_{thJK}$ (K/W)
DC	0.46
180°	0.48
120°	0.50
60°	0.54
30°	0.58

Constants for  $Z_{thJK}$  calculation:

i	$R_{thi}$ (K/W)	$t_i$ (s)
1	0.013	0.0012
2	0.072	0.047
3	0.175	0.394
4	0.2	1.32